

ULTRA WIDE BAND, HIGH SLEW RATE SINGLE OPERATIONAL AMPLIFIER

■ GENERAL DESCRIPTION

The NJM2136, NJM2137 and NJM2138 are single, dual and quad operational amplifiers operated from low voltage ($\pm 1.35V$). A 200MHz gain bandwidth and $45V/\mu s$ high slew rate make them suitable for use as active filter, high-speed analog and digital signal processor, industrial measurement equipment and others.

It can also be suitable for portable communication items because of low operating voltage and low operating current.

■ FEATURES

- Operating Voltage $\pm 1.35V \sim \pm 6V$
- Wide Bandwidth 200MHz typ.
- High Slew Rate $45V/\mu s$ typ.
- Input Offset Voltage Balance (only NJM2136)
- Operating Current
 - NJM2136: 0.63mA typ.
 - NJM2137: 1.14mA typ.
 - NJM2138: 2.27mA typ.
- Bipolar Technology
- Package Outline
 - NJM2136: DMP8, SSOP8
 - NJM2137: DIP8, DMP8, SSOP8
 - NJM2138: DMP14, SSOP14

■ PACKAGE OUTLINE

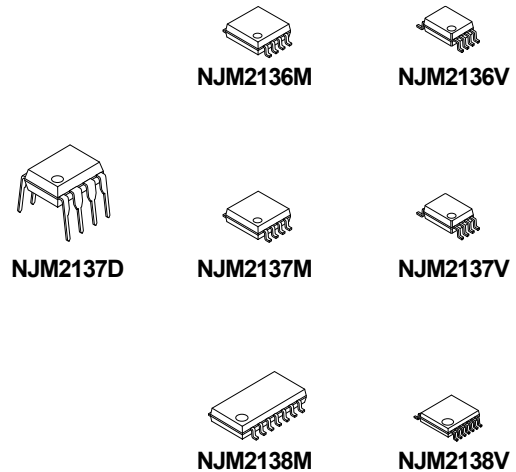

■ PIN CONFIGURATION

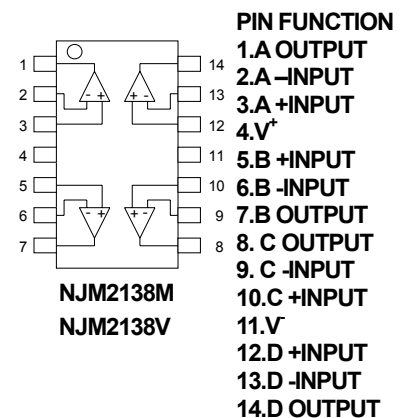
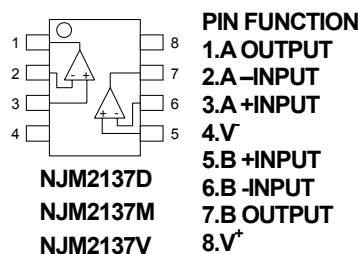
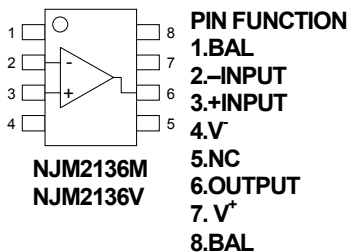

■ EQUIVALENT CIRCUIT (each amplifier)

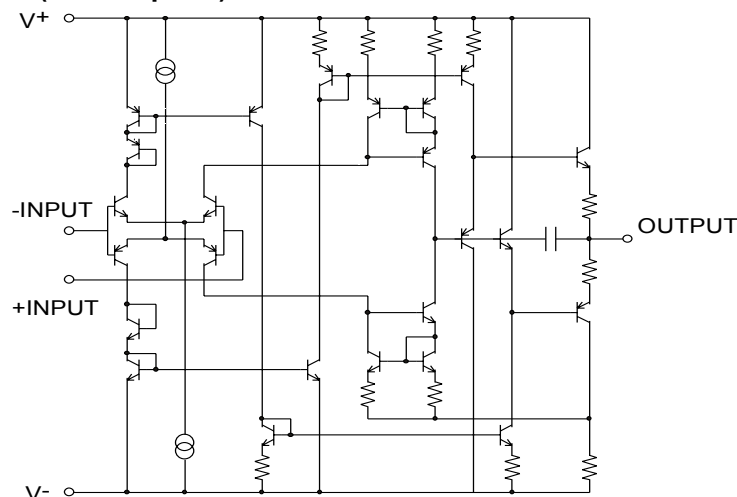

NJM2136/37/38

■ ABSOLUTE MAXIMUM RATINGS

(Ta=25°C)

PARAMETER	SYMBOL	RATINGS	UNIT
Supply Voltage	V^+/V^-	± 6.75	V
Differential Input Voltage	V_{ID}	± 3	V
Power Dissipation	P_D	(DIP8) 500 (DMP8) 300 (SSOP8) 250 (DMP14) 300 (SSOP14) 300	mW
Operating Temperature Range	T_{opr}	-40~+85	°C
Storage Temperature Range	T_{stg}	-50~+125	°C

■ ELECTRICAL CHARACTERISTICS

($V^+/V^- = \pm 2.5V, Ta=25^\circ C$)

PARAMETER	SYMBOL	TEST CONDITION	MIN.	TYP.	MAX.	UNIT
Operating Voltage	V^+/V^-		± 1.35	-	± 6.00	V
Input Offset Voltage	V_{IO}	$R_S=0\Omega$	-	1.0	5.0	mV
Input Bias Current	I_B		-	0.5	2.0	μA
Input Offset Current	I_{IO}		-	20	200	nA
Large Signal Voltage Gain	A_V	$R_L \geq 2k\Omega$	65	75	-	dB
Input Common Mode Voltage Range	V_{ICM}		± 1.2	± 1.5	-	V
Common Mode Rejection Ratio	CMR	$-1V \leq V_{cm} \leq +1V$	45	60	-	dB
Supply Voltage Rejection Ratio	+SVR	NJM2136	70	80	-	dB
	-SVR		50	60	-	
	+SVR	NJM2137/NJM2138	50	60	-	
	-SVR		70	80	-	
Maximum Output Voltage Swing	V_{OM}	$R_L=1k\Omega$	1.1 -0.9	1.4 -1.2	- -	V
Operating Current (all Amp.)	I_{CC}	NJM2136, $R_L=\infty$	-	0.63	0.82	mA
		NJM2137, $R_L=\infty$	-	1.14	1.50	
		NJM2138, $R_L=\infty$	-	2.27	3.00	
Slew Rate	SR	$A_V=0dB$	-	45	-	V/ μs
Gain Bandwidth Product	GB	60dB • 500kHz	120	200	-	MHz
Phase Margin	ϕ_M	40dB	-	25	-	deg.
Unity Gain Bandwidth	f_T	40dB	-	40	-	MHz

■ OFFSET ADJUSTMENT METHOD (only NJM2136)

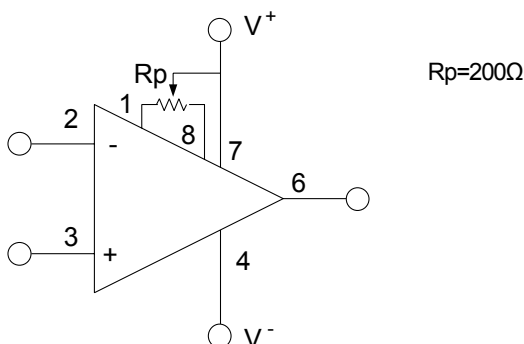

(note) The electrical characteristics change a little, in case the R_P is connected.

■ TYPICAL CHARACTERISTICS

Operating Current vs. Supply Voltage
 $G_V=0\text{dB}$, $T_a=25^\circ\text{C}$

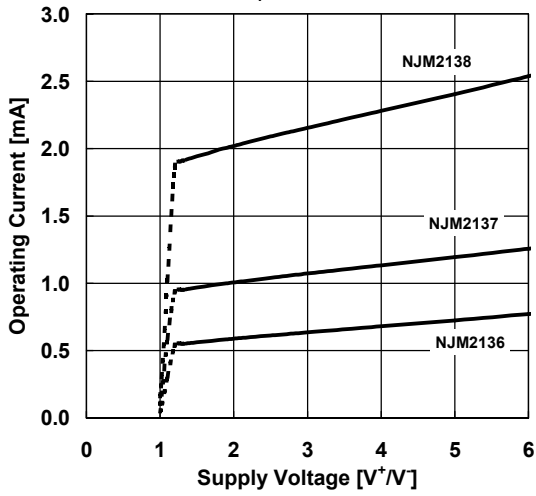

Operating Current vs. Temperature
 $V^+/V=\pm 2.5\text{V}$, $G_V=0\text{dB}$

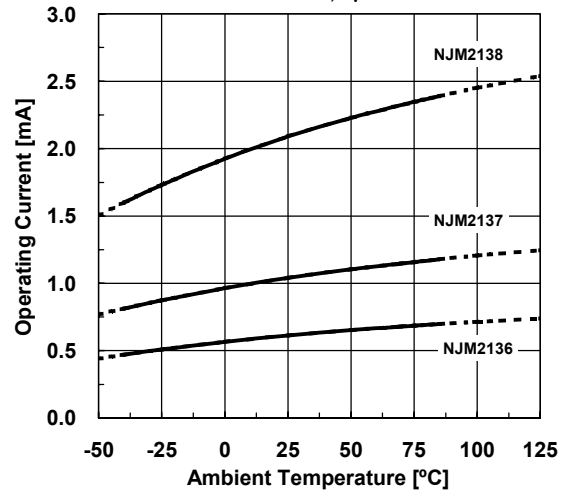

Input Offset Voltage vs. Temperature
 $V^+/V=\pm 2.5\text{V}$, $G_V=0\text{dB}$, $T_a=25^\circ\text{C}$

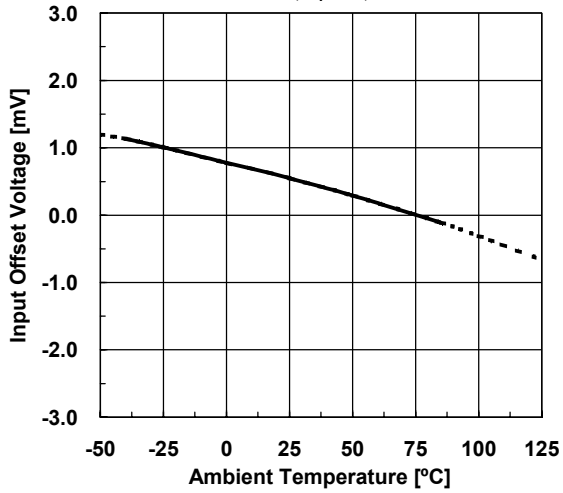

Input Offset Current vs. Temperature
 $V^+/V=\pm 2.5\text{V}$, $G_V=0\text{dB}$, $T_a=25^\circ\text{C}$

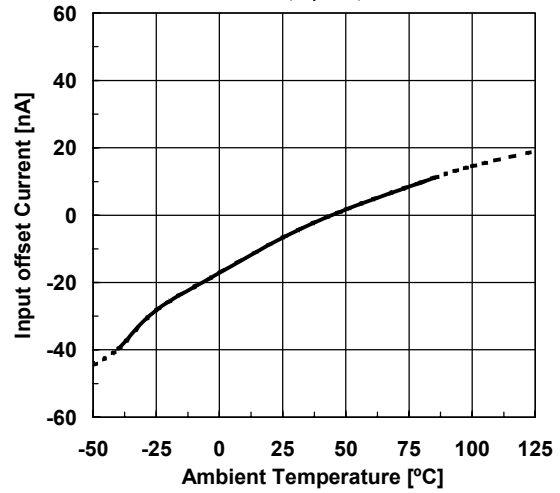

Input Bias Current vs. Temperature
 $V^+/V=\pm 2.5\text{V}$, $G_V=0\text{dB}$, $T_a=25^\circ\text{C}$

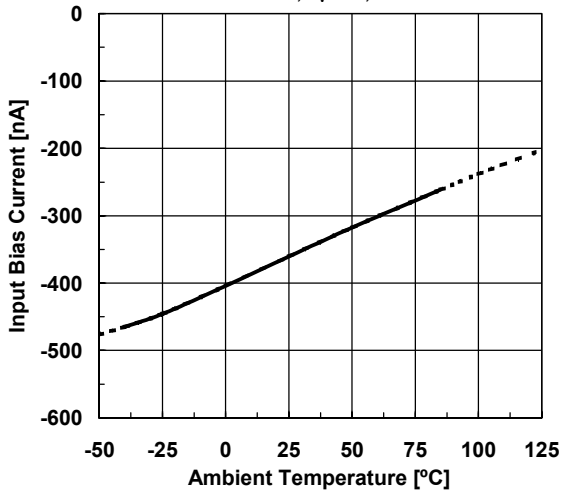

NJM2136/37/38

■ TYPICAL CHARACTERISTICS

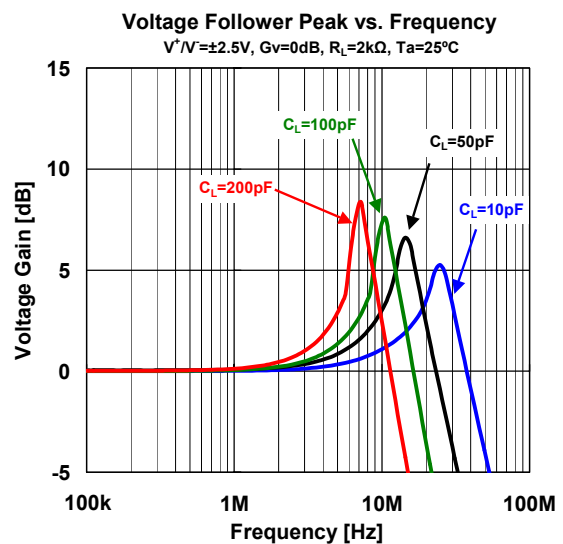
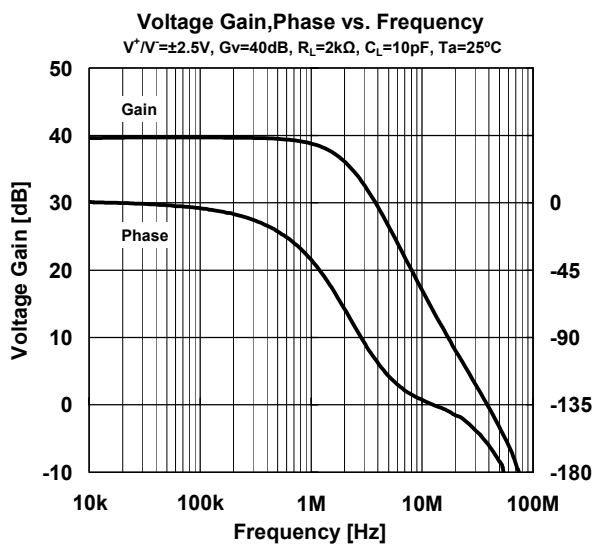
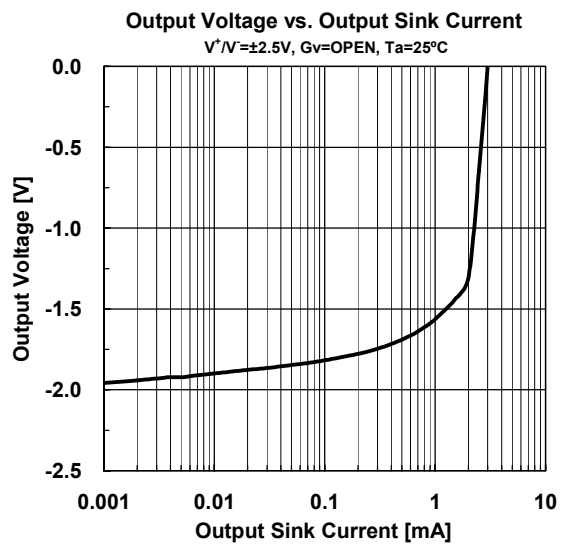
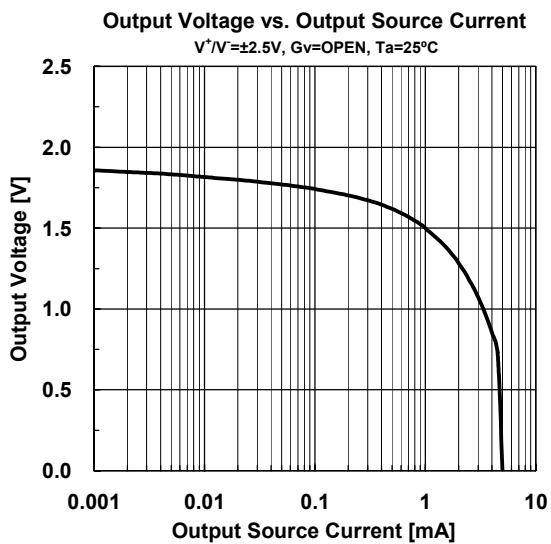
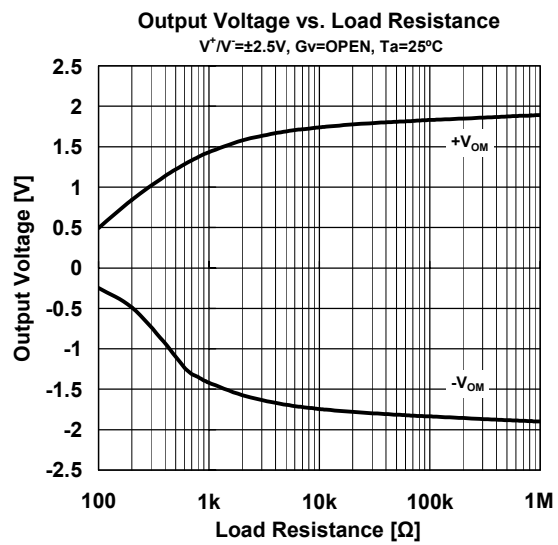
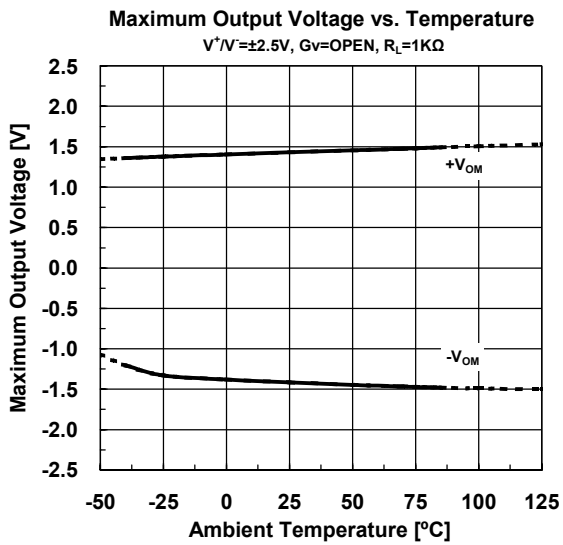

■ TYPICAL CHARACTERISTICS

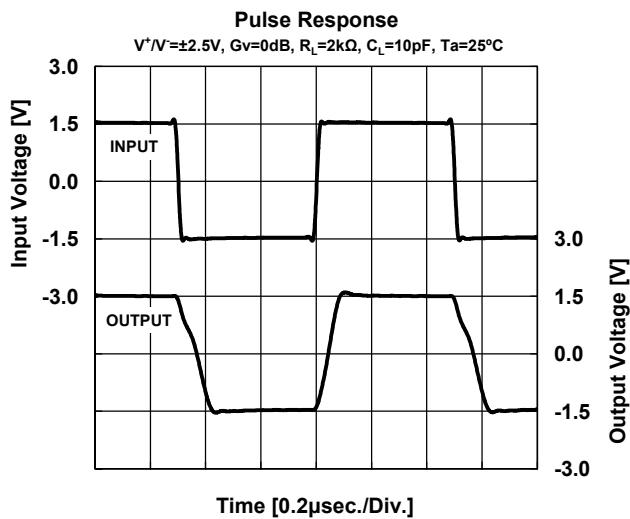
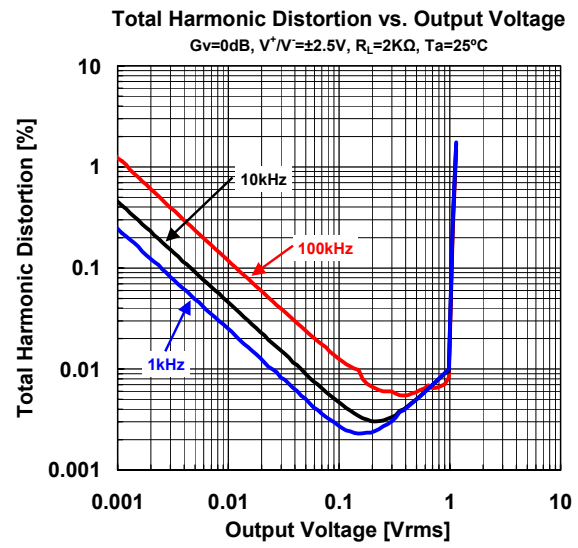
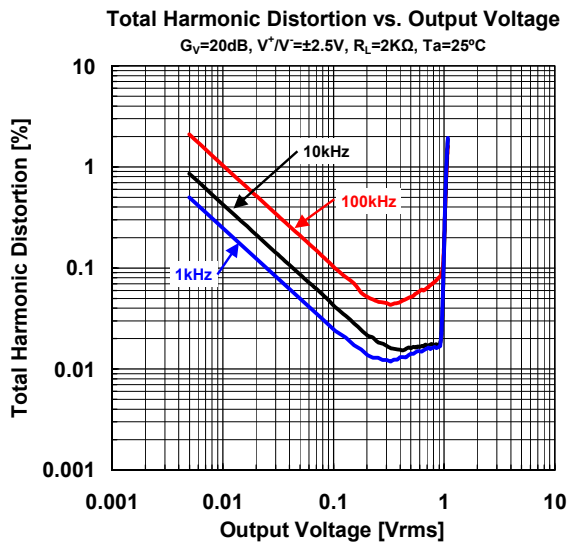



[CAUTION]

The specifications on this databook are only given for information, without any guarantee as regards either mistakes or omissions. The application circuits in this databook are described only to show representative usages of the product and not intended for the guarantee or permission of any right including the industrial rights.

Looking for pricing, stock, or lifecycle information?

Click below to explore more details on WIN SOURCE:

-  [View NJM2136M on WIN SOURCE](#)
-  [NJR Corporation/NJRC Information](#)

Optimize Your Supply Chain with WIN SOURCE Solutions

-  Global Sourcing Solution
-  Obsolete Management
-  Cost Control Management
-  Shortage Management
-  Alternative Solution
-  Excess Inventory Management