

ULTRA LOW NOISE DUAL OPERATIONAL AMPLIFIER

■ GENERAL DESCRIPTION

The NJM2122 is an ultra low noise dual operational amplifier.

The features of ultra low noise, low operating voltage, and low saturation voltage are suitable for microphone amplifier of digital audio items such as portable MD, DAT, and others.

■ FEATURES

- Operating Voltage ($\pm 2.0V \sim \pm 7.0V$)
- Ultra Low Noise Voltage ($1.5nV/\sqrt{Hz}$ typ. @ $f=1kHz$)
- Low Saturation Output Voltage ($0.3V$ typ.)
- Bipolar Technology
- Package Outline DIP8, DMP8

■ PACKAGE OUTLINE

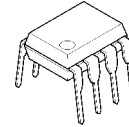

NJM2122D



NJM2122M

■ PIN CONFIGURATION

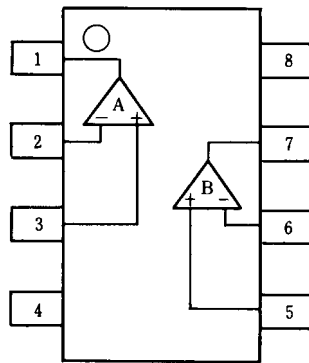

NJM2122D
NJM2122M

PIN FUNCTION

- 1.A OUTPUT
- 2.A -INPUT
- 3.A +INPUT
- 4.V⁻
- 5.B +INPUT
- 6.B -INPUT
- 7.B OUTPUT
- 8.V⁺

■ EQUIVALENT CIRCUIT (1/2 Shown)

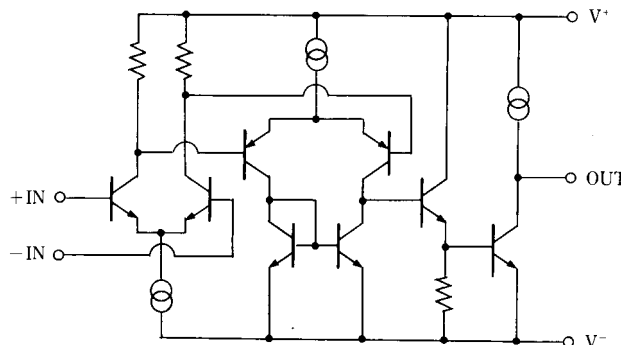

NJM2122

■ ABSOLUTE MAXIMUM RATINGS

(Ta=25°C)

PARAMETER	SYMBOL	RATINGS	UNIT
Supply Voltage	V ⁺ /V	± 10	V
Differential Input Voltage	V _{ID}	± 0.5	V
Input Voltage	V _{IC}	± 10 (note)	V
Power Dissipation	P _D	(DIP8) 500 (DMP8) 300	mW
Operating Temperature Range	T _{opr}	-20~+75	°C
Storage Temperature Range	T _{stg}	-40~+125	°C

(note) When the supply voltage is less than ±10V, the absolute maximum input voltage is equal to the supply voltage.

■ ELECTRICAL CHARACTERISTICS

(V⁺=5V, Ta=25°C)

PARAMETER	SYMBOL	TEST CONDITION	MIN.	TYP.	MAX.	UNIT
Operating Voltage 1	Vo _{pe1}	DIP Package	± 2.0	-	± 10.0	V
Operating Voltage 2	Vo _{pe2}	DMP Package	± 2.0	-	± 7.0	V
Operating Current	I _{CC}	V _{IN} =0V, R _L =∞Ω	-	7.0	9.5	mA
Input Offset Voltage	V _{IO}	R _S =500Ω	-	1.0	6.0	mV
Input Offset Current	I _{IO}		-	0.45	1.50	μA
Input Bias Current	I _B		-	3.6	8.0	μA
Large Signal Voltage Gain	A _V	R _L ≥10kΩ	80	100	-	dB
Input Common Mode Voltage Range	V _{ICM}		± 0.7	± 1.0	-	V
Common Mode Rejection Ratio	CMR		60	74	-	dB
Supply Voltage Rejection Ratio	SVR		60	80	-	dB
Maximum Output Voltage	V _{OM}	R _L ≥2.5kΩ	± 2.0	± 2.2	-	V
Slew Rate	SR	G _V =20dB, V _{IN} =± 0.1V	-	2.4	-	V/μs
Gain Bandwidth Product	GB		-	12	-	MHz
Equivalent Input Noise Voltage 1	e _{n1}	R _S =10Ω, f=1kHz	-	1.5	-	nV/√Hz
Equivalent Input Noise Voltage 2	e _{n2}	*Figure1	-	0.56	0.75	μVrms
Channel Separation	CS	f=1kHz	-	90	-	dB
Total Harmonic Distortion	THD	V _O =1Vrms, f=1kHz G _V =20dB, R _L =2.5kΩ	-	0.003	-	%

(note) Between 30 to 50dB voltage gain is recommended.

In case of voltage gain less than 30dB, phase compensation by external circuit is required.

The voltage follower circuit must not be used.

DMP package should be used in operating voltage less than ±7V, because of the P_D limitation.

Figure1

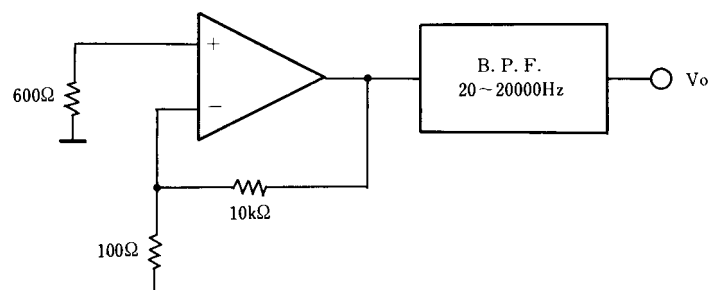

■ TYPICAL CHARACTERISTICS

Operating Current vs. Operating Voltage

($T_a=25^\circ\text{C}$)

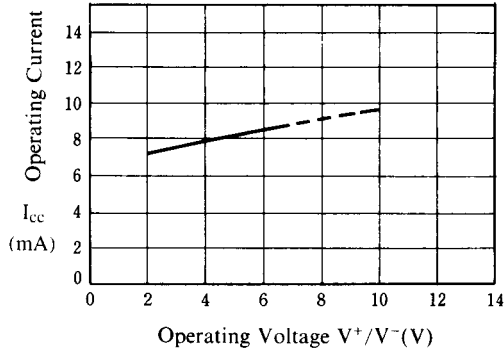

Maximum Output Voltage vs. Operating Voltage

($T_a=25^\circ\text{C}$)

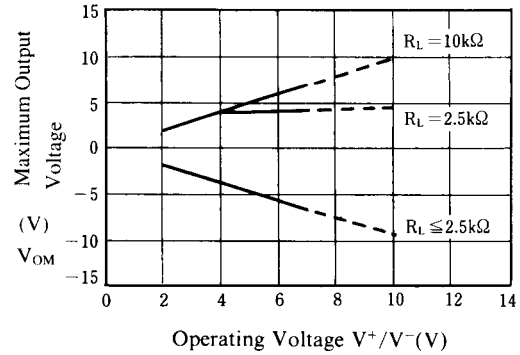

Input Offset Voltage vs. Operating Voltage

($T_a=25^\circ\text{C}$)

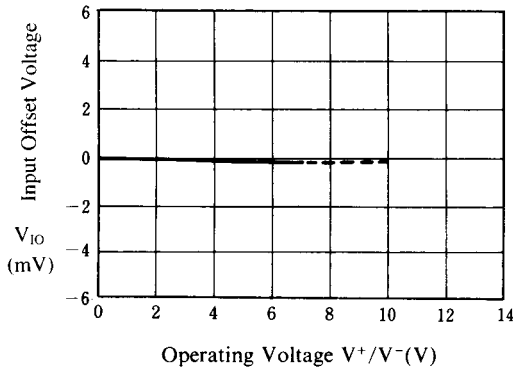

Input Bias Current vs. Operating Voltage

($T_a=25^\circ\text{C}$)

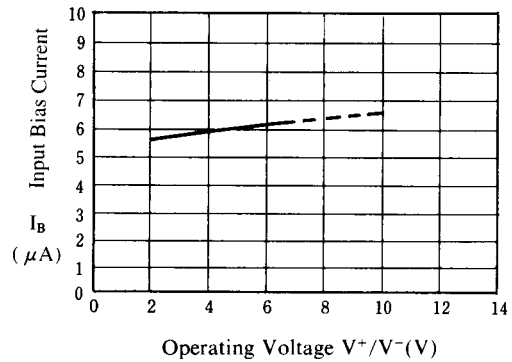

Input Offset Voltage vs. Temperature

($V^+/V^- = \pm 2.5\text{V}$)

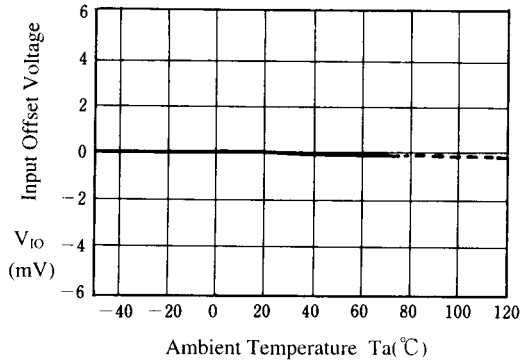

Input Bias Current vs. Temperature

($V^+/V^- = \pm 2.5\text{V}$)

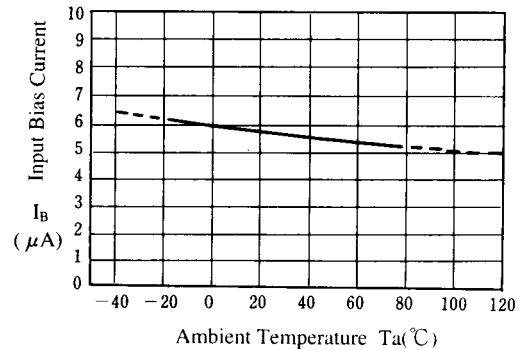

■ TYPICAL CHARACTERISTICS

Operating Current vs. Temperature

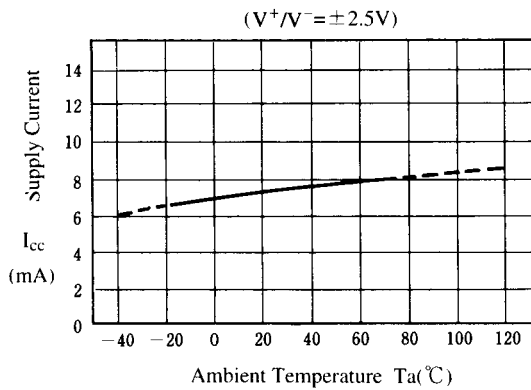

Maximum Output Voltage vs. Temperature

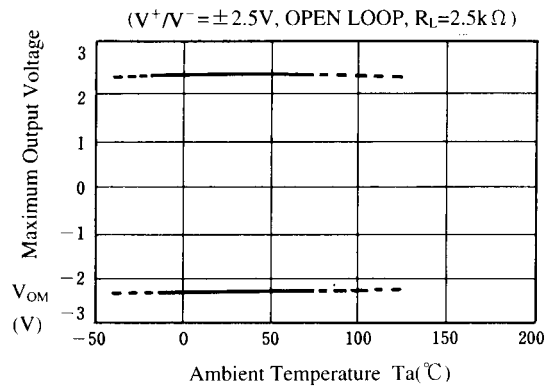

Maximum Output Voltage vs. Frequency

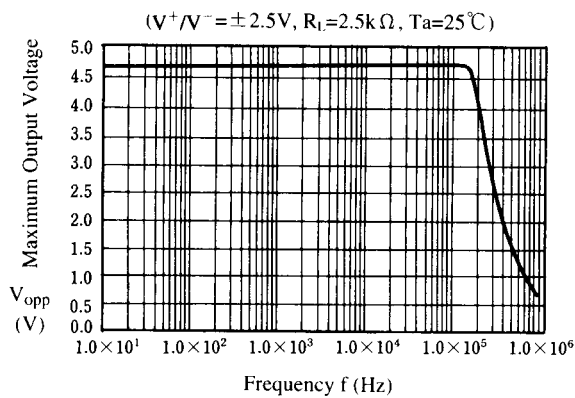

Maximum Output Voltage vs. Load Resistance

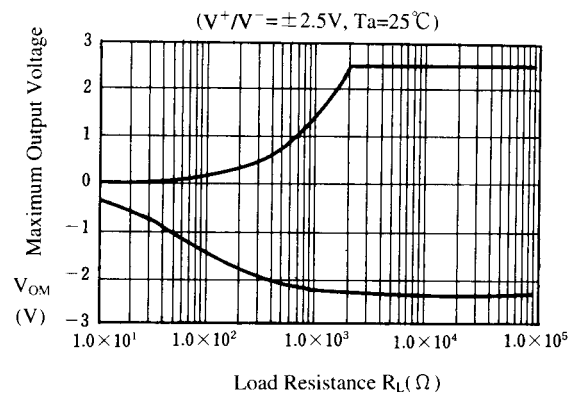

Equivalent Input Noise Voltage vs. Source Resistance

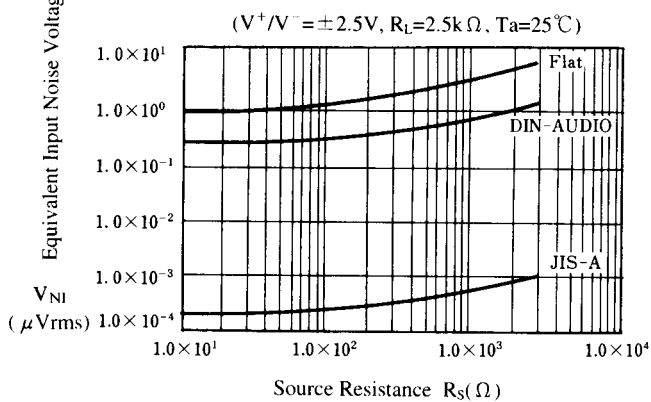

Output Voltage vs. Source Resistance

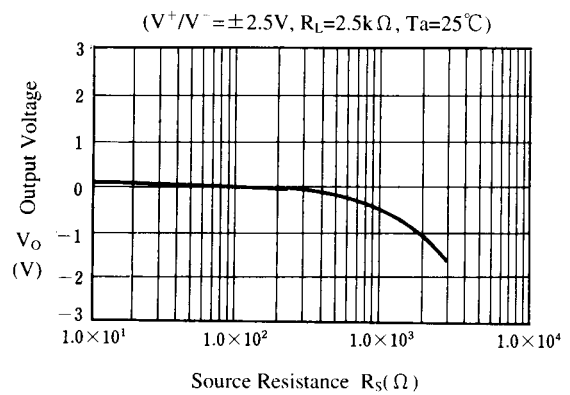

■ TYPICAL CHARACTERISTICS

Maximum Output Voltage Swing vs. Output Current

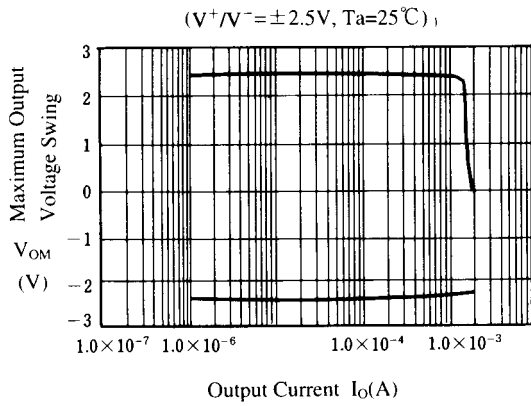

Total Harmonic Distortion vs. Output Voltage

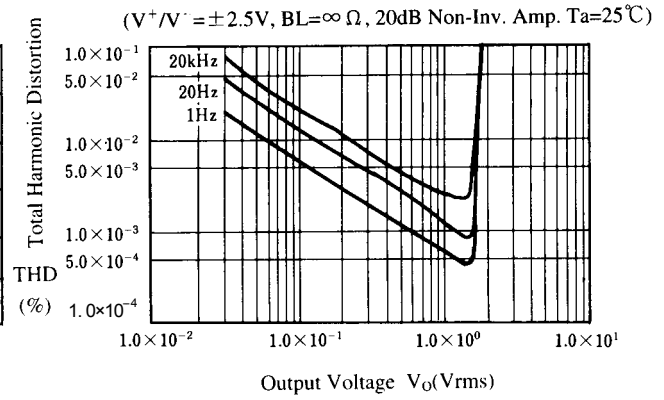

Equivalent Input Noise Voltage vs. Frequency

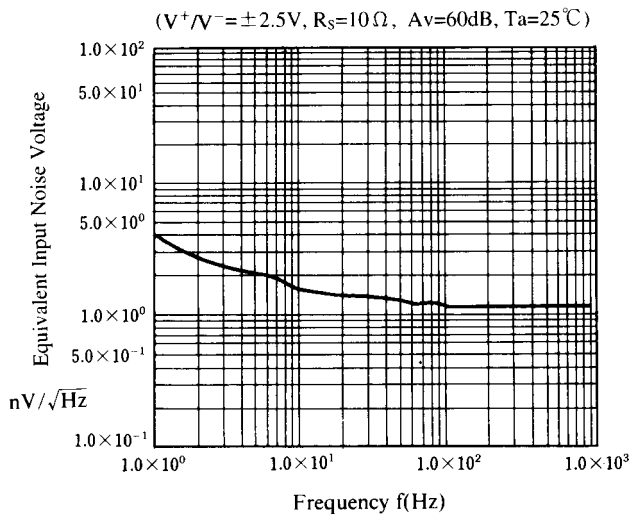

[CAUTION]

The specifications on this databook are only given for information, without any guarantee as regards either mistakes or omissions. The application circuits in this databook are described only to show representative usages of the product and not intended for the guarantee or permission of any right including the industrial rights.

Looking for pricing, stock, or lifecycle information?

Click below to explore more details on WIN SOURCE:

- ⊖ [View NJM2122M on WIN SOURCE](#)
- ⊖ [NJR Corporation/NJRC Information](#)

Optimize Your Supply Chain with WIN SOURCE Solutions

- ✓ Global Sourcing Solution
- ✓ Obsolete Management
- ✓ Cost Control Management
- ✓ Shortage Management
- ✓ Alternative Solution
- ✓ Excess Inventory Management