



**THE DATASHEET OF  
NJM2076M-TE1**



## DUAL LOW VOLTAGE POWER AMPLIFIER

### ■ GENERAL DESCRIPTION

The NJM2076 is a dual power amplifier, which operates with 1.0V minimum supply voltage. The NJM2076 is suitable to small radio and head-phone of stereo and single BTL application.

### ■ FEATURES

- BTL operation  $P_o=90mW$  type.
- Minimum external components
- Headphone stereo Amp. with external transistors
- Low Operation Voltage (1.0V MIN.)
- Low Operating Current (4.7mA TYP.)
- Package Outline DIP8, DMP8
- Bipolar Technology

### ■ PACKAGE OUTLINE

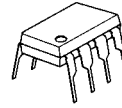

NJM2076D



NJM2076M

### ■ PIN CONFIGURATION

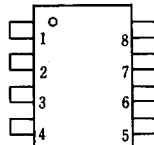

NJM2076D  
NJM2076M

#### PIN FUNCTION

1. Inverting Amp. Input (A)
2. Non-Inverting Amp. Input(B)
3.  $V^+$
4. Base(B)
5. (B) Output
6. GND
7. (A) Output
8. Base (A)

## ■ ABSOLUTE MAXIMUM RATINGS

(Ta=25°C)

PARAMETER	SYMBOL	RATINGS	UNIT
Supply Voltage	V*	4.5	V
Maximum Input Signal	V <sub>IN</sub>	200	mVrms
Power Dissipation	P <sub>D</sub>	(DIP 8) 500 (DMP 8) 500	mW
Operating Temperature Range	T <sub>opr</sub>	-20~+75	°C
Storage Temperature Range	T <sub>stg</sub>	-40~+125	°C

## ■ ELECTRICAL CHARACTERISTICS

(Ta=25°C, V\*=1.5V)

PARAMETER	SYMBOL	TEST CONDITION	MIN.	TYP.	MAX.	UNIT
Operating Current	I <sub>cc</sub>	Input: Open	—	4.7	7.0	mA

(I) Stereo Configuration (Test Circuit 1, R<sub>L</sub>=16Ω)

Voltage Gain	A <sub>v</sub>	V <sub>IN</sub> =10mVrms	26.5	28.0	29.5	dB
Max. Output Power	P <sub>O1</sub>	THD=10%(D, M-Type)	15	17.5	—	mW
	P <sub>O2</sub>	THD=10%, V <sup>+</sup> =1.0V	—	3	—	mW
Total Harmonic Distortion	THD <sub>1</sub>	P <sub>O</sub> =1mW (126mVrms/16Ω)	—	0.4	0.8	%
Output Noise Voltage	V <sub>NO1</sub>	R <sub>g</sub> =0, A Curve	—	50	150	μV
Ripple Rejection Ratio	RR <sub>1</sub>	R <sub>g</sub> =0, f <sub>R</sub> =1kHz, V <sub>R</sub> =30mvrms	25	35	—	dB
Input Resistance	R <sub>IN</sub>		25	33	43	kΩ
Output Pin Voltage	V <sub>O</sub> (DC)		0.62	0.70	0.77	V

(II) BTL Configuration (Test Circuit 2, R<sub>L</sub>=8Ω)

Max. Output power	P <sub>O3</sub>	THD=10% (D,M-Type)	75	90	—	mW
	P <sub>O4</sub>	THD=10%. V <sup>+</sup> =1.0V(D, M-Type)	—	20	—	mW
Total Harmonic Distortion	THD <sub>2</sub>	P <sub>O</sub> =10mW(283mVrms/8Ω)	—	1.5	4.5	%
Output Noise Voltage	V <sub>NO2</sub>	R <sub>g</sub> =0, A Curve	—	85	250	μV
Ripple Rejection Ratio	RR <sub>2</sub>	R <sub>g</sub> =0, f <sub>R</sub> =1kHz, V <sub>R</sub> =30mVrms	20	25	—	dB
Voltage Difference between Two Output Pins	ΔV <sub>O</sub> (DC)		—	—	50	mV

## ■ TEST CIRCUIT

· Test Circuit 1  
Stereo Configuration

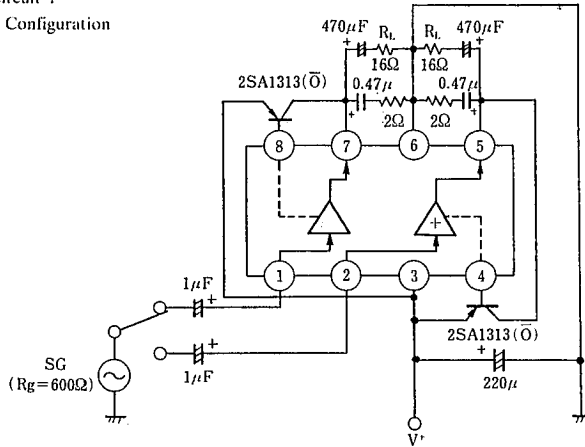

2SA1313(O):  $h_{FE}=115\sim 125$   
( $I_c=100\text{mA}$ )

· Test Circuit 2  
BTL Configuration

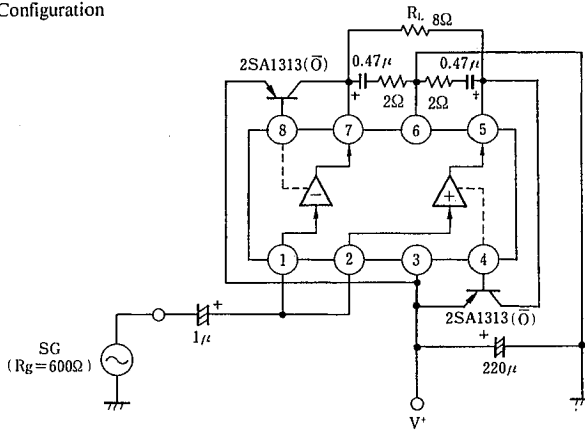

5

## ■ TYPICAL CHARACTERISTICS

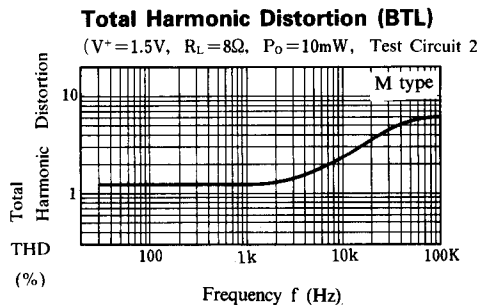
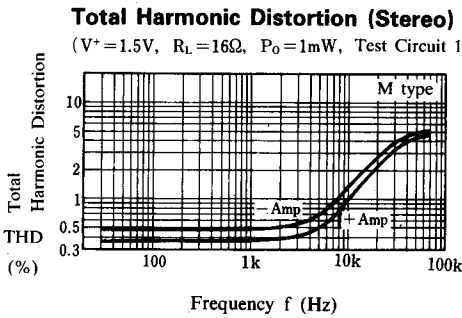
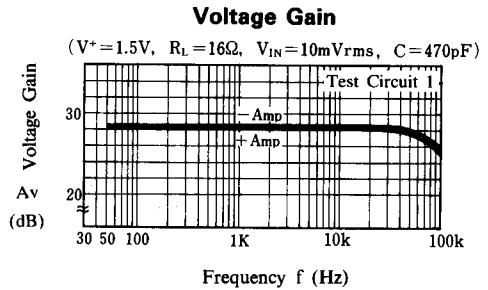
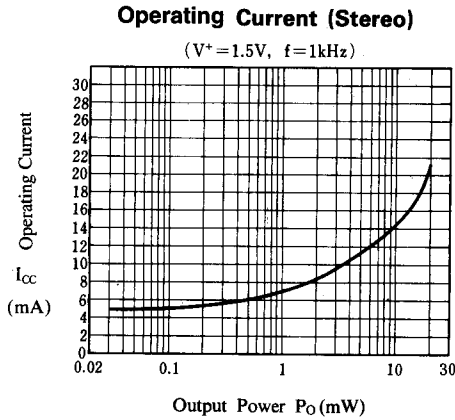
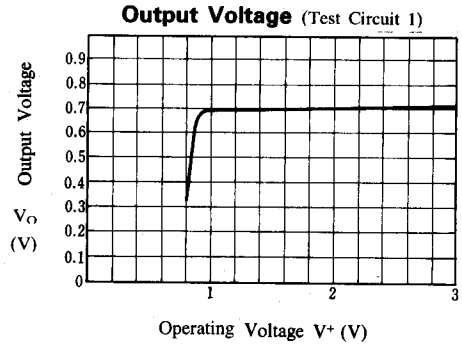
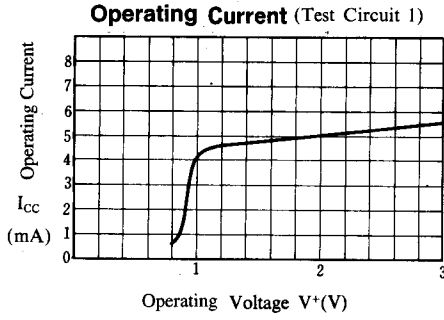

■ TYPICAL CHARACTERISTICS

**Total Harmonic Distortion (Stereo)**

( $V^+ = 1.5V$ ,  $R_L = 16\Omega$ ,  $f = 1kHz$ , Test Circuit 1)

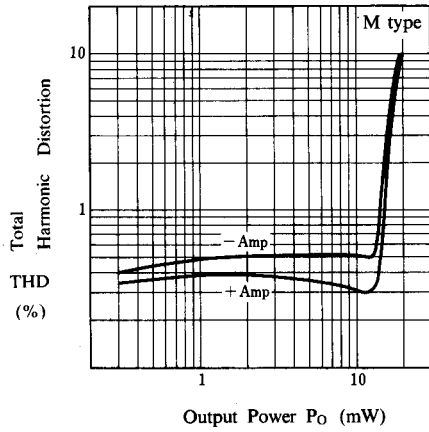

**Total Harmonic Distortion (BTL)**

( $V^+ = 1.5V$ ,  $R_L = 8\Omega$ ,  $f = 1kHz$ , Test Circuit 2)

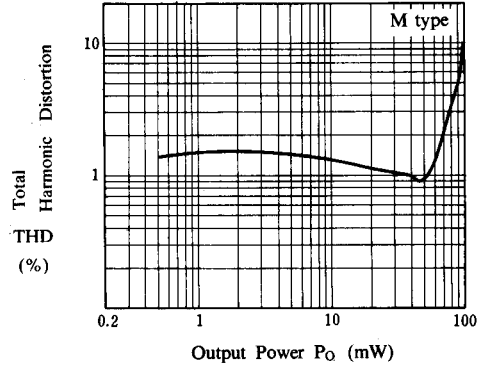

## ■ TYPICAL APPLICATION

### 1. For Stereo Head-Phone

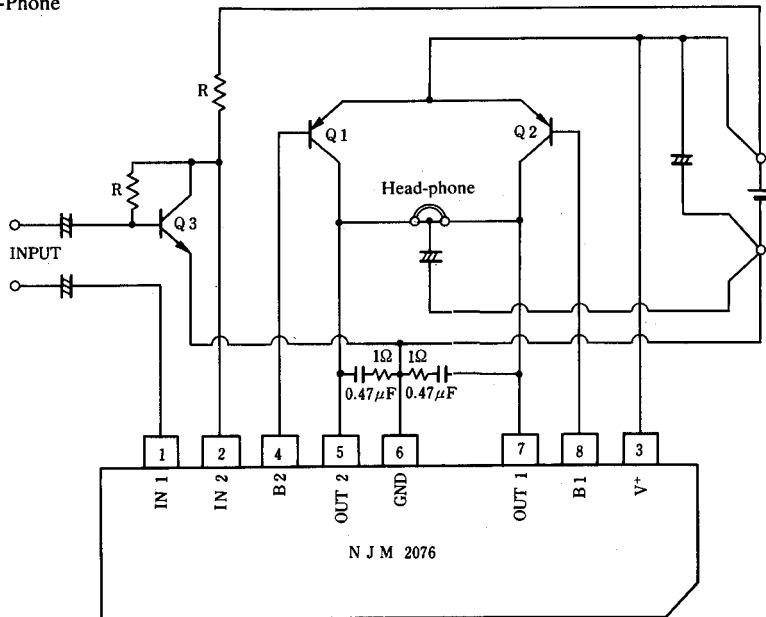

### 2. BTL Amp. for Speaker

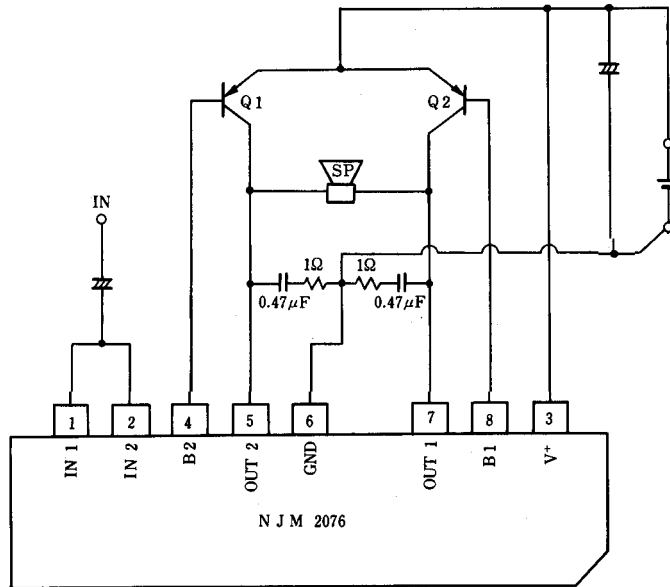

**■ NOTICE****(1) External PNP Transistor**

Maximum output power becomes large with low saturation voltage transistor, and so select transistor of low saturation.  
Saturation Voltage: less than 0.1V ( $I_c=100\text{mA}$ ,  $I_B=10\text{mA}$ ).  $h_{FE}: 120$

**(2) External Frequency Compensation**

Recommend tantalum capacitor with low  $\tan\delta$  (less than 0.25 at  $f=10\text{kHz}$ ) and  $1\Omega$  resistor. Stable with large capacitor of less high frequency distortion and worse  $\tan\delta$ . For example:  $1\mu\text{F}$ ,  $\tan\delta \leq 0.6$

**(3) Layout on PCB**

Be careful to get maximum output power and low distortion set.

DIP/DMP: Signal ground has to be close to IC ground pin. Impedance of ground line must be low.

## MEMO

[CAUTION]







The specifications on this databook are only given for information, without any guarantee as regards either mistakes or omissions. The application circuits in this databook are described only to show representative usages of the product and not intended for the guarantee or permission of any right including the industrial rights.

## Looking for pricing, stock, or lifecycle information?

Click below to explore more details on WIN SOURCE:

-  [View NJM2076M-TE1 on WIN SOURCE](#)
-  [Nisshinbo Micro Devices Inc. Information](#)

## Optimize Your Supply Chain with WIN SOURCE Solutions

-  Global Sourcing Solution
-  Obsolete Management
-  Cost Control Management
-  Shortage Management
-  Alternative Solution
-  Excess Inventory Management