

## SINGLE SUPPLY DUAL OPERATIONAL AMPLIFIER

### ■ GENERAL DESCRIPTION

The NJM13404 is single-supply dual operational amplifier, which can operate from 2V supply. The features are low offset voltage, low bias current, high slew-rate, and free crossover distortion through the AB class output stage.

The package lineup is DIP, DMP and others compact, so that the NJM13404 is suitable for audio for low voltage operation and any other kind of signal amplifier.

### ■ FEATURES

- Operating Voltage ( +2V~+14V )
- Slew Rate ( 1.2V/μs typ. )
- Operating Current ( 2.0mA typ. )
- Bipolar Technology
- Package Outline DIP8,DMP8,EMP8,SSOP8  
VSP8,SIP8

### ■ PACKAGE OUTLINE

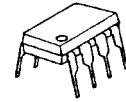

NJM13404D



NJM13404M



NJM13404E



NJM13404V



NJM13404R

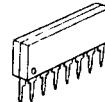

NJM13404L

### ■ PIN CONFIGURATION

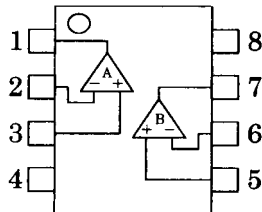

NJM13404D/13404M  
NJM13404E/13404V/13404R

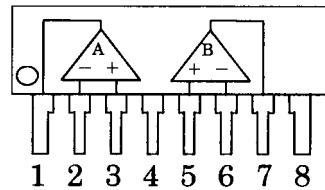

NJM13404L

- PIN FUNCTION**  
 1.A OUTPUT  
 2.A -INPUT  
 3.A +INPUT  
 4.GND  
 5.B +INPUT  
 6.B -INPUT  
 7.B OUTPUT  
 8.V<sup>+</sup>

### ■ EQUIVALENT CIRCUIT ( 1/2 Shown )

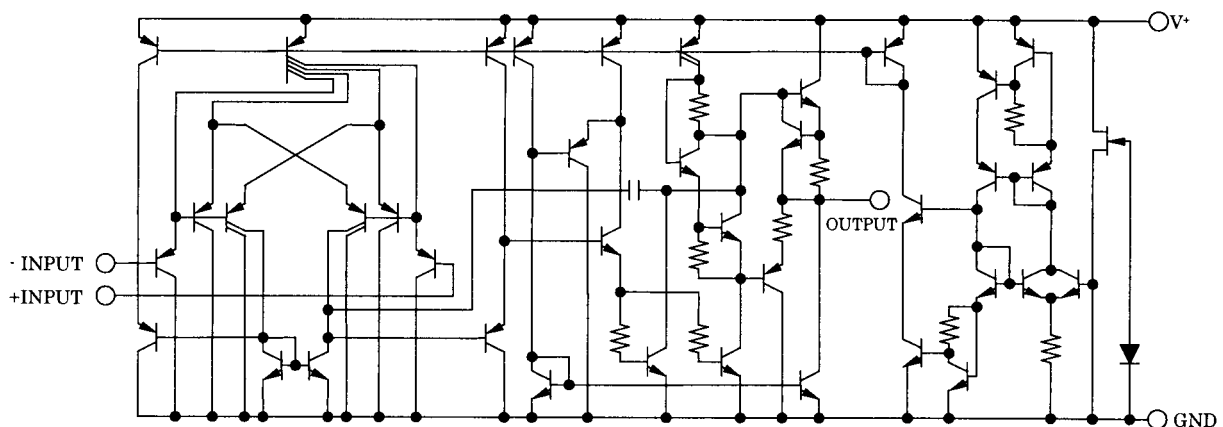

# NJM13404

## ■ ABSOLUTE MAXIMUM RATINGS

( Ta=25°C )

PARAMETER	SYMBOL	RATINGS	UNIT
Supply Voltage	$V^+$	15	V
Differential Input Voltage	$V_{ID}$	14	V
Input Voltage	$V_{IC}$	-0.3~+14	V
Power Dissipation	$P_D$	( DIP8 ) 500 ( DMP8 ) 300 ( EMP8 ) 300 ( SSOP8 ) 250 ( VSP8 ) 320 ( SIP8 ) 800	mW
Operating Temperature Range	$T_{opr}$	-40~+85	°C
Storage Temperature Range	$T_{stg}$	-40~+125	°C

## ■ ELECTRICAL CHARACTERISTICS

(  $V^+=5V, Ta=25°C$  )

PARAMETER	SYMBOL	TEST CONDITION	MIN.	TYP.	MAX.	UNIT
Operating Voltage	$V_{opr}$		2	-	14	V
Input Offset Voltage	$V_{IO}$	$R_S=0\Omega$	-	0.5	4	mV
Input Offset Current	$I_{IO}$		-	5	50	nA
Input Bias Current	$I_B$		-	25	150	nA
Large Signal Voltage Gain	$A_V$	$R_L \geq 2k\Omega$	88	100	-	dB
Maximum Output Voltage Swing	$V_{OM}$	$R_L=2k\Omega$	4.0	4.2	-	V
Input Common Mode Voltage Range	$V_{ICM}$		0~3.5	-	-	V
Common Mode Rejection Ratio	CMR		70	90	-	dB
Supply Voltage Rejection Ratio	SVR		80	94	-	dB
Output Source Current	$I_{SOURCE}$	$V_{IN}^+=1V, V_{IN}^-=0V$	20	35	-	mA
Output Sink Current	$I_{SINK}$	$V_{IN}^+=0V, V_{IN}^-=1V$	10	30	-	mA
Operating Current	$I_{CC}$	$R_L=\infty$	-	2.0	3.5	mA
Slew Rate	SR	$V^+/V^-=\pm 2.5V, R_L=2k\Omega,$ $A_V=0dB, f=1kHz$	-	1.2	-	V/ $\mu s$
Unity Gain Bandwidth	$f_T$	$R_L=2k\Omega$	-	2.0	-	MHz
Total Harmonic Distortion	THD	$R_L=2k\Omega, A_V=40dB,$ $f=20kHz, V_O=1V_{rms}$	-	0.2	-	%

## ■ TYPICAL CHARACTERISTICS

NJM13404 Operating Current vs. Operating Voltage

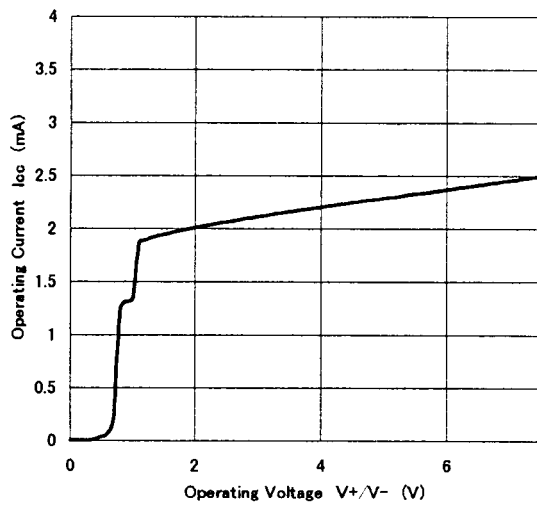

NJM13404 Input Offset Voltage vs. Operating Voltage

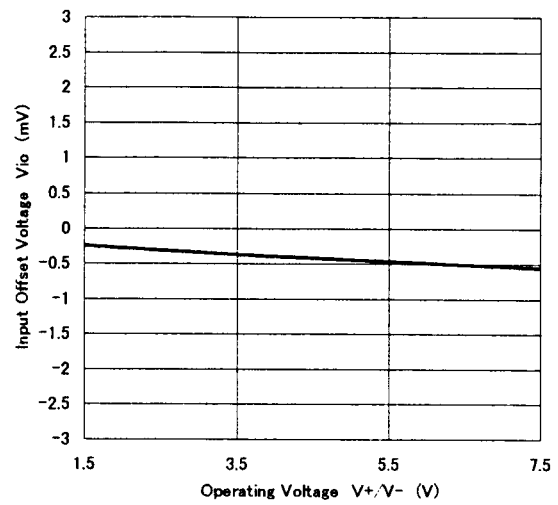

NJM13404 Input Bias Current vs. Operating Voltage

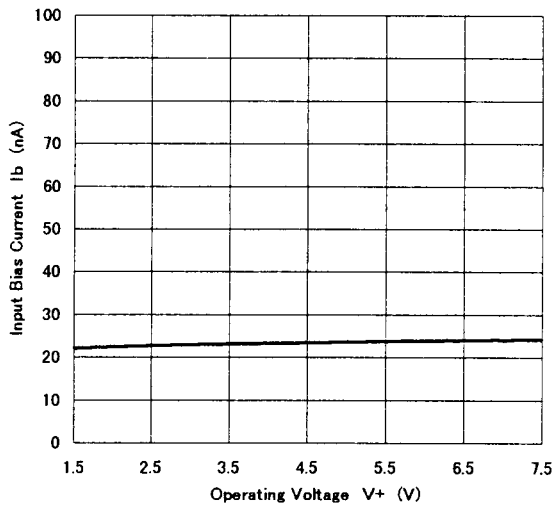

NJM13404 Maximum Output Voltage Swing vs. Operating Voltage

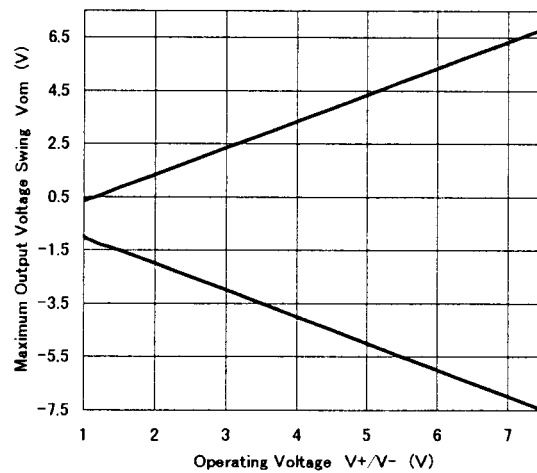

NJM13404 Input Common Mode Input Voltage Range

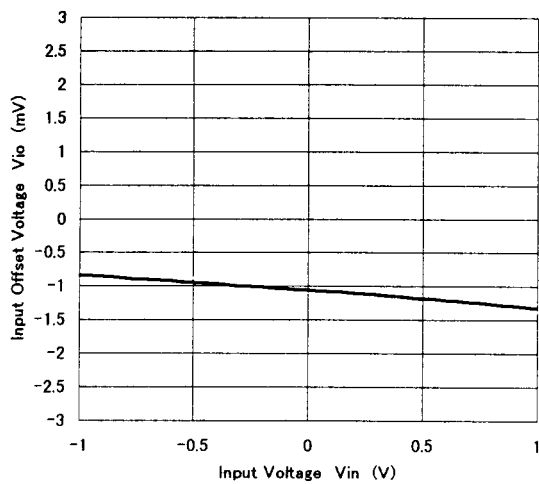

# NJM13404

## ■ TYPICAL CHARACTERISTICS

NJM13404 Maximum Output Voltage Swing v.s Load Resistance

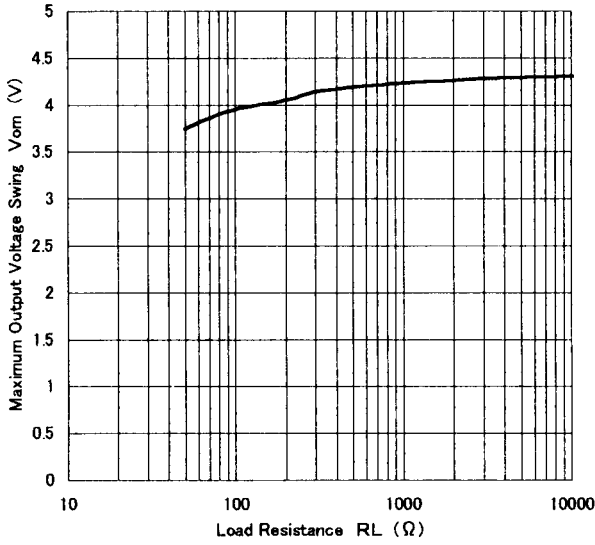

NJM13404 Maximum Output Voltage Swing v.s Frequency

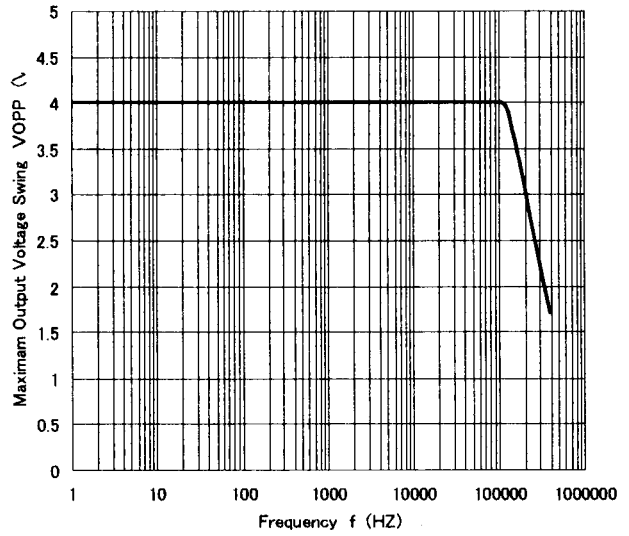

NJM13404 Output Voltage v.s Output Sink Current

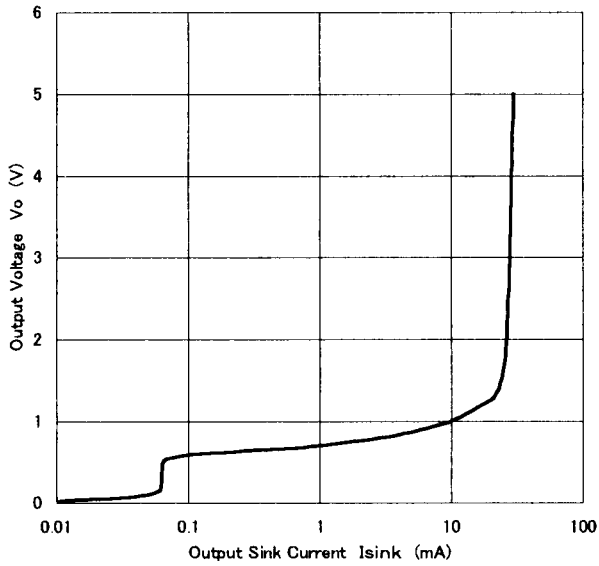

NJM13404 Output Voltage v.s Output Source Current

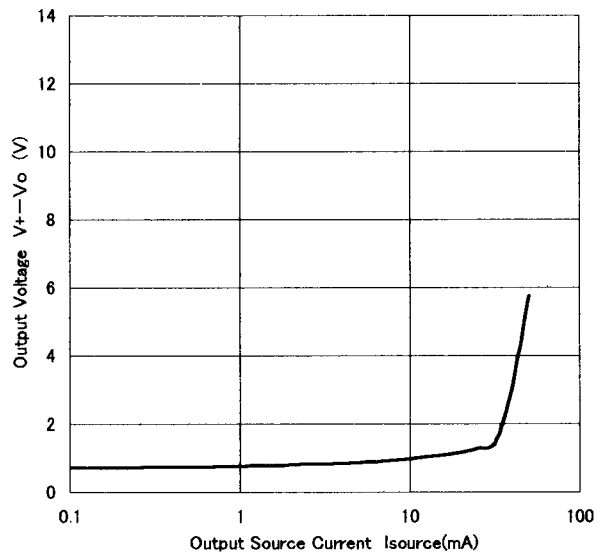

## ■ TYPICAL CHARACTERISTICS

NJM13404 Large Signal Voltage Gain vs. Operating Voltage

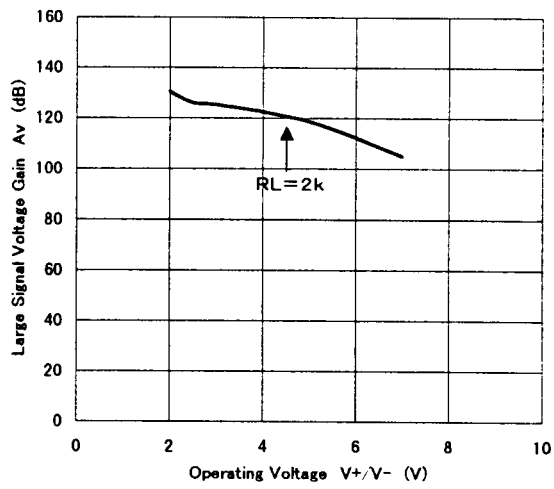

NJM13404 Large Signal Voltage Gain vs. Frequency

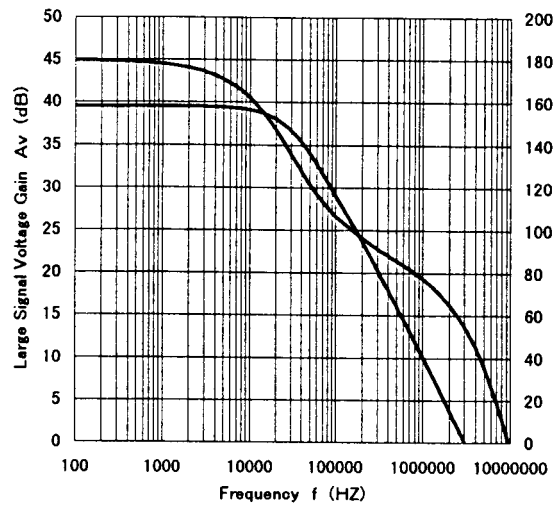

NJM13404 Slew Rate(Fall)

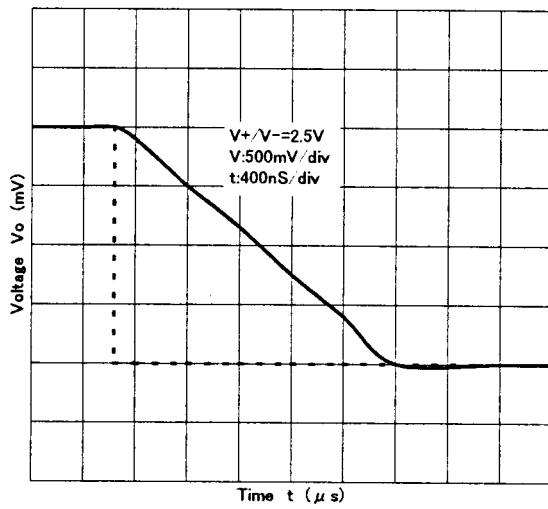

NJM13404 Slew Rate(Rise)

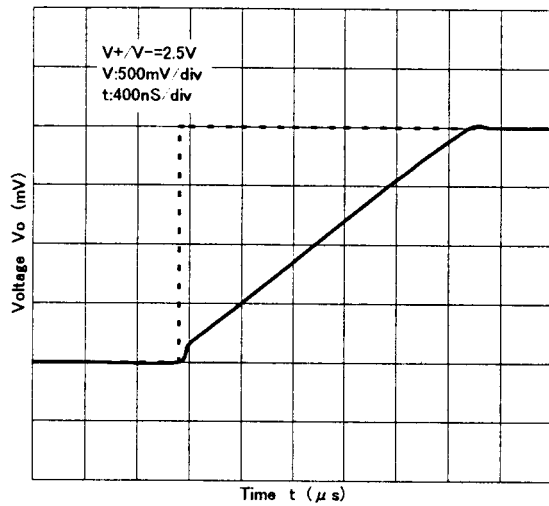

NJM13404 THD v.s Output Voltage

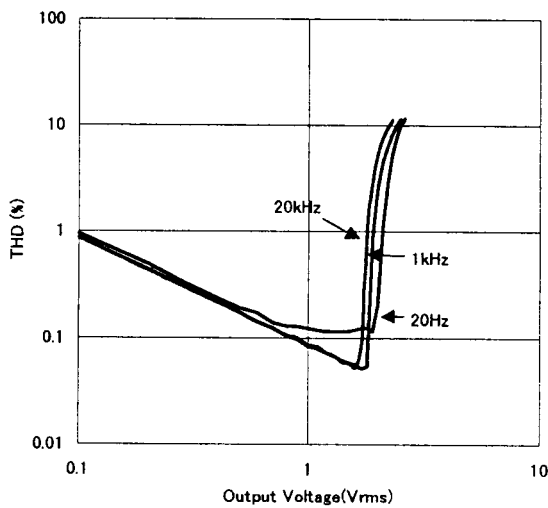

NJM13404 Equivalent Input Noise Voltage v.s Frequency

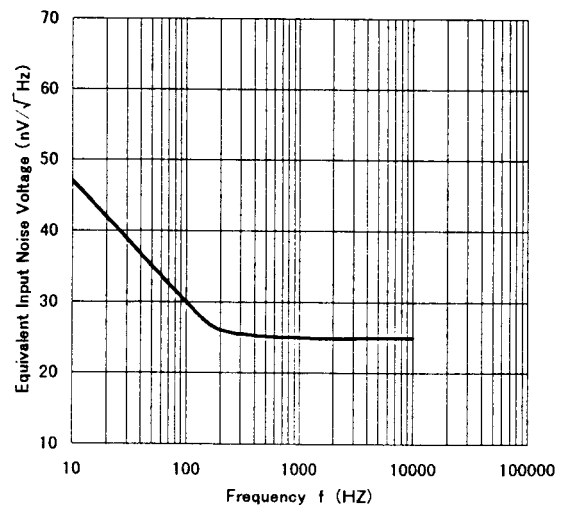

# NJM13404

## TYPICAL CHARACTERISTICS

NJM13404 Operating Current vs. Temperature

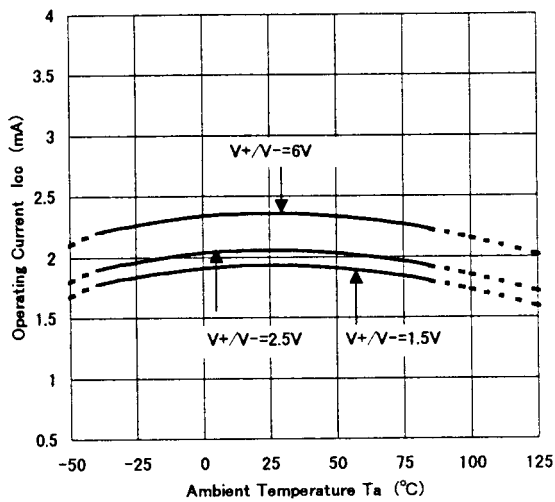

NJM13404 Input Offset Voltage vs. Temperature

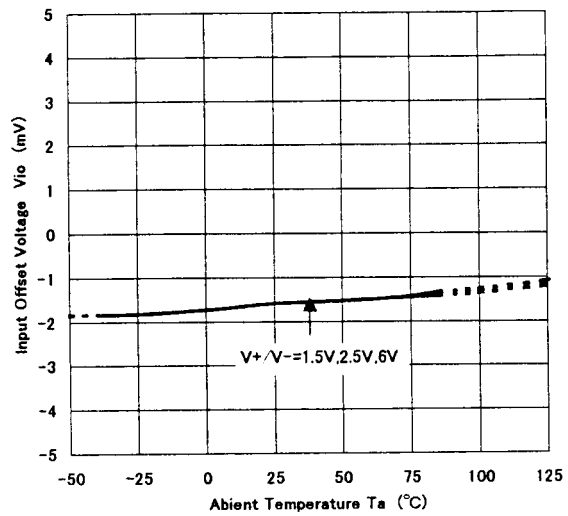

NJM13404 Input Bias Current vs. Temperature

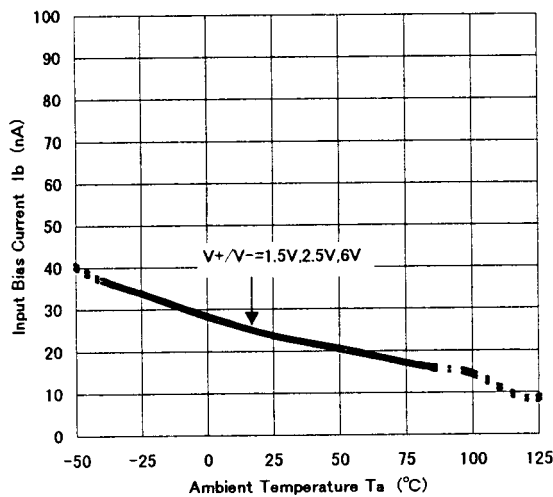

NJM13404 Maximum Output Voltage Swing vs. Temperature

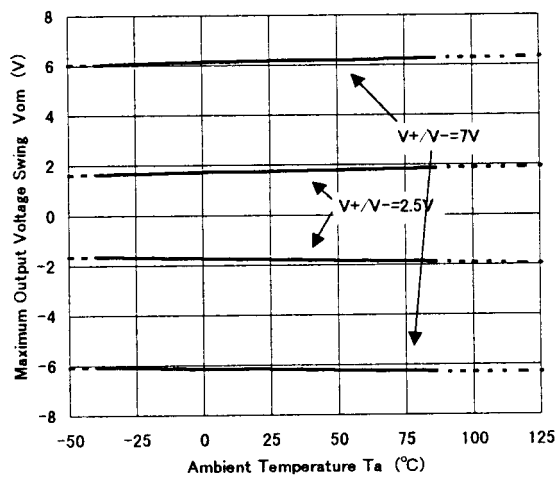

NJM13404 Output Sink Current vs. Temperature

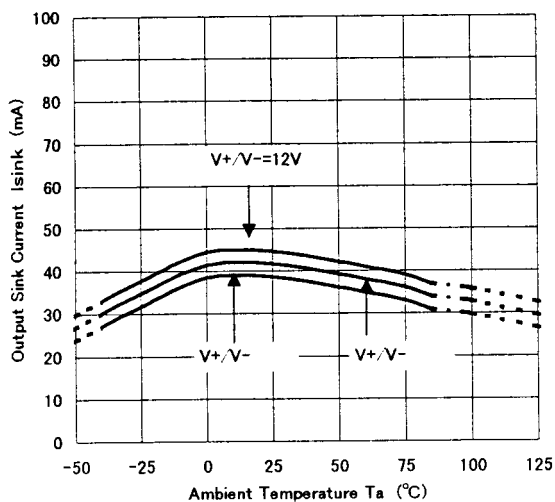

NJM13404 Output Source Current vs. Temperature

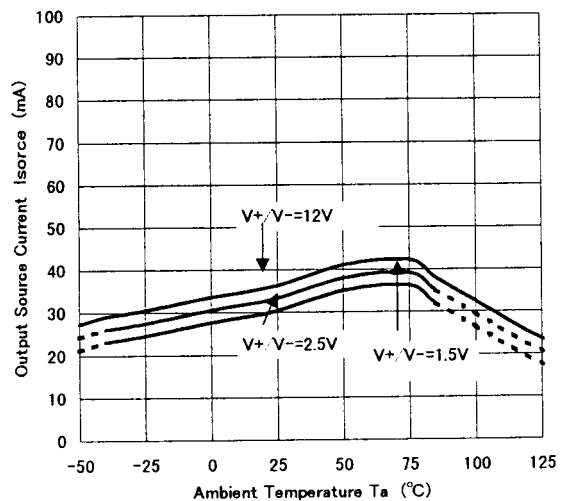

## ■ TYPICAL CHARACTERISTICS

NJM13404 Large Signal Voltage Gain vs. Temperature

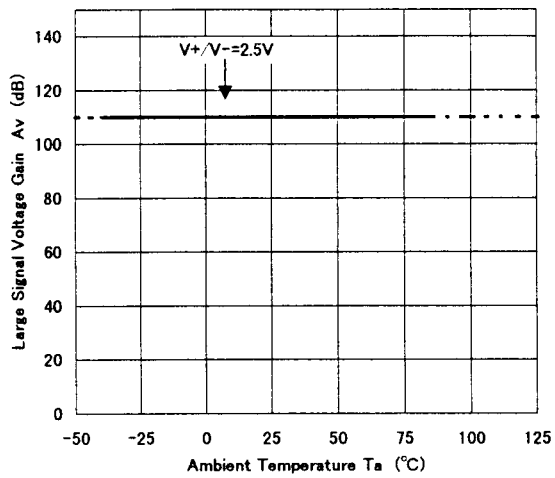

NJM13404 Common Mode Rejection Ratio vs. Temperature

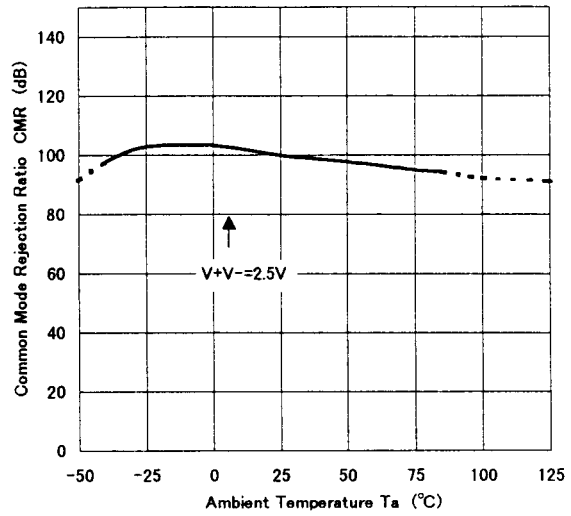

NJM13404 Supply Voltage Rejection Ratio vs. Temperature

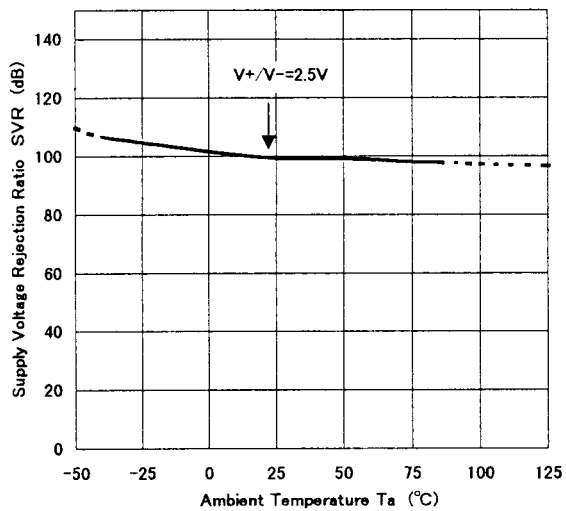



**[CAUTION]**

The specifications on this databook are only given for information, without any guarantee as regards either mistakes or omissions. The application circuits in this databook are described only to show representative usages of the product and not intended for the guarantee or permission of any right including the industrial rights.

## Looking for pricing, stock, or lifecycle information?

Click below to explore more details on WIN SOURCE:

-  [View NJM13404D on WIN SOURCE](#)
-  [NJR Corporation/NJRC Information](#)

## Optimize Your Supply Chain with WIN SOURCE Solutions

-  Global Sourcing Solution
-  Obsolete Management
-  Cost Control Management
-  Shortage Management
-  Alternative Solution
-  Excess Inventory Management