



# NJG1522KB2

## ■ ABSOLUTE MAXIMUM RATINGS

( $T_a=25^\circ\text{C}$ ,  $Z_S=Z_L=50\Omega$ )

PARAMETERS	SYMBOL	CONDITIONS	RATINGS	UNITS
Input Power	$P_{IN}$	$V_{CTL(L)}=0V$ , $V_{CTL(H)}=2.7V$	28	dBm
Control Voltage	$V_{CTL}$	$V_{CTL(H)} - V_{CTL(L)}$	7.5	V
Power Dissipation	$P_D$		450	mW
Operating Temp.	$T_{opr}$		-30~+85	$^\circ\text{C}$
Storage Temp.	$T_{stg}$		-55~+125	$^\circ\text{C}$

## ■ ELECTRICAL CHARACTERISTICS

( $V_{CTL(L)}=0V$ ,  $V_{CTL(H)}=2.7V$ ,  $Z_S=Z_L=50\Omega$ ,  $T_a=25^\circ\text{C}$ )

PARAMETERS	SYMBOL	CONDITIONS	MIN	TYP	MAX	UNITS
Control voltage (Low)	$V_{CTL(L)}$		-0.2	0	0.2	V
Control voltage (High)	$V_{CTL(H)}$		2.5	2.7	6.5	V
Control current	$I_{CTL}$	$f=2.0\text{GHz}$ , $P_{IN}=10\text{dBm}$	-	8	14	$\mu\text{A}$
Insertion loss 1	LOSS1	$f=1.0\text{GHz}$ , $P_{IN}=0\text{dBm}$	-	0.3	0.6	dB
Insertion loss 2	LOSS2	$f=2.0\text{GHz}$ , $P_{IN}=0\text{dBm}$	-	0.5	0.8	dB
Isolation 1 (PC-P1, PC-P2, P1-P2)	ISL1	$f=1.0\text{GHz}$ , $P_{IN}=0\text{dBm}$	25.5	27	-	dB
Isolation 2 (PC-P1, PC-P2, P1-P2)	ISL2	$f=2.0\text{GHz}$ , $P_{IN}=0\text{dBm}$	25	27	-	dB
Pin at 1dB compression point	$P_{-1\text{dB}}$	$f=2.0\text{GHz}$	20	24	-	dBm
VSWR (PC, P1, P2)	VSWR	$f=0.05\sim 2.2\text{GHz}$ , ON State	-	1.3	1.6	
Switching time	$T_{SW}$	$f=0.05\sim 2.5\text{GHz}$	-	20	-	ns

## ■ TERMINAL INFORMATION

No.	SYMBOL	DESCRIPTIONS
1	P1	RF port. This port is connected with PC port by controlling 6 <sup>th</sup> pin ( $V_{CTL(H)}$ ) to 2.5~6.5V and 4 <sup>th</sup> pin ( $V_{CTL(L)}$ ) to -0.2~+0.2V. An external capacitor is required to block the DC bias voltage of internal circuit. (50~100MHz: 0.01uF, 0.1~0.5GHz: 1000pF, 0.5~2.5GHz: 56pF)
2	GND	Ground terminal. Please connect this terminal with ground plane as close as possible for excellent RF performance.
3	P2	RF port. This port is connected with PC port by controlling 4 <sup>th</sup> pin ( $V_{CTL(H)}$ ) to 2.5~6.5V and 6 <sup>th</sup> pin ( $V_{CTL(L)}$ ) to -0.2~+0.2V. An external capacitor is required to block the DC bias voltage of internal circuit. (50~100MHz: 0.01uF, 0.1~0.5GHz: 1000pF, 0.5~2.5GHz: 56pF)
4	VCTL2	Control port 2. The voltage of this port controls PC to P2 state. The 'ON' and 'OFF' state is toggled by controlling voltage of this terminal such as high-state (2.5~6.5V) or low-state (-0.2~+0.2V). The voltage of 6 <sup>th</sup> pin have to be set to opposite state. The bypass capacitor has to be chosen to reduce switching time delay from 10pF~1000pF range.
5	PC	Common RF port. In order to block the DC bias voltage of internal circuit, an external capacitor is required. (50~100MHz: 0.01uF, 0.1~0.5GHz: 1000pF, 0.5~2.5GHz: 56pF)
6	VCTL1	Control port 1. The voltage of this port controls PC to P2 state. The 'ON' and 'OFF' state is toggled by controlling voltage of this terminal such as high-state (2.5~6.5V) or low-state (-0.2~+0.2V). The voltage of 4 <sup>th</sup> pin have to be set to opposite state. The bypass capacitor has to be chosen to reduce switching time delay from 10pF~1000pF range.

# NJG1522KB2

## ELECTRICAL CHARACTERISTICS

(0.1~3.0GHz, with Application circuit, Losses of external circuit are excluded)

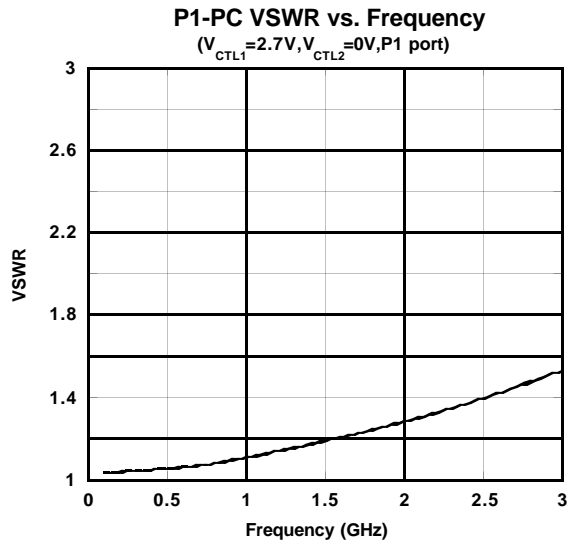
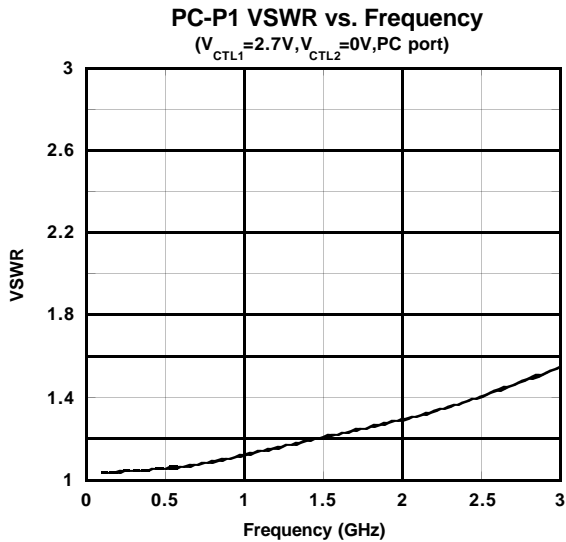
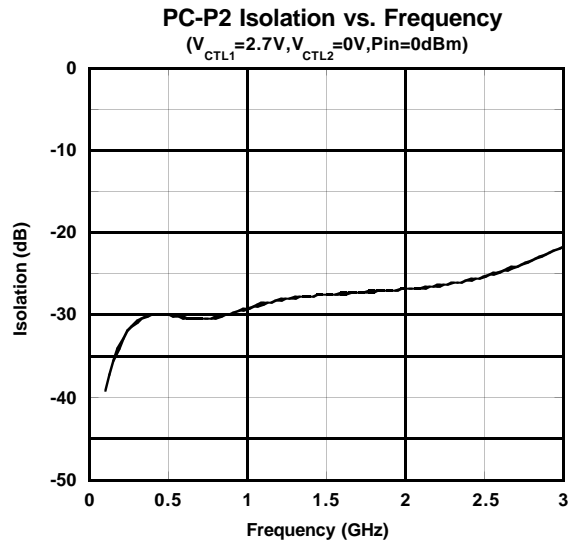
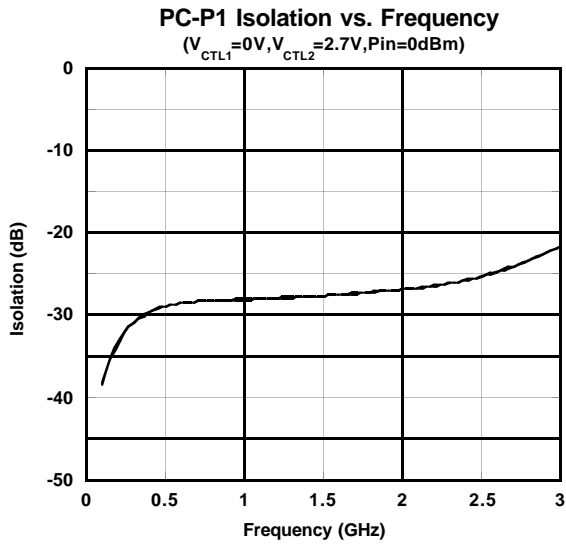
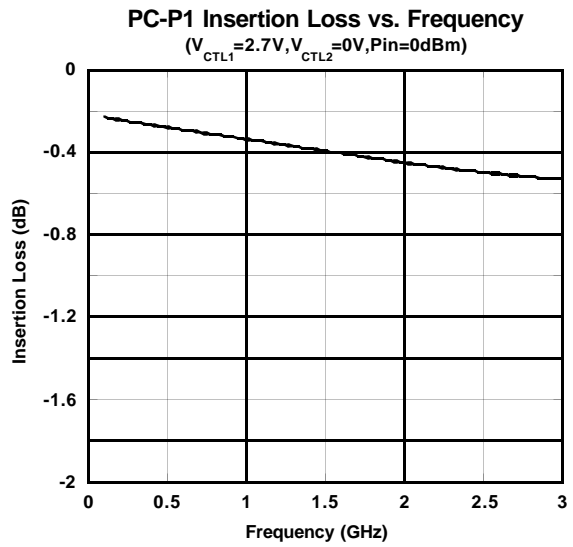
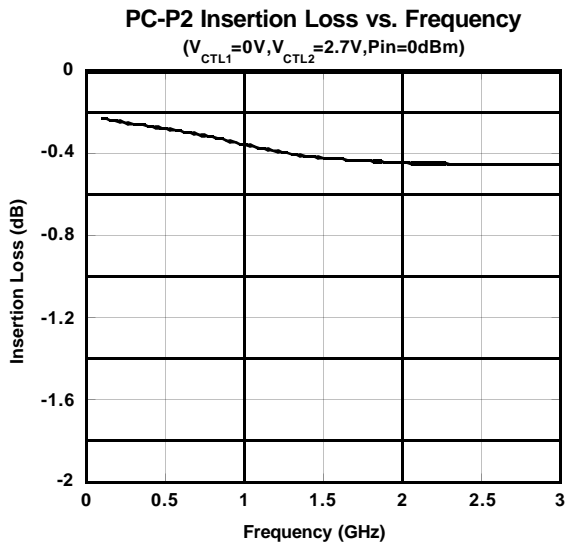

## ■ ELECTRICAL CHARACTERISTICS

(with application circuit, without DC Blocking Capacitor, Losses of external circuit are excluded)

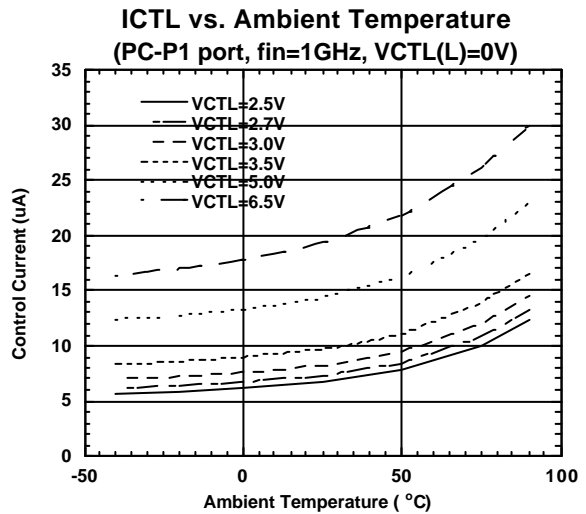
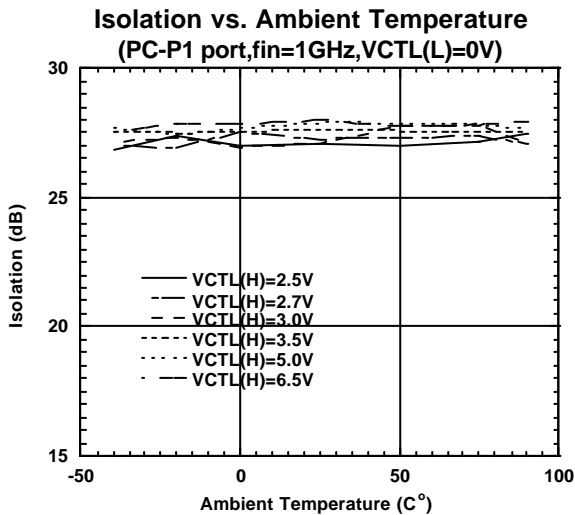
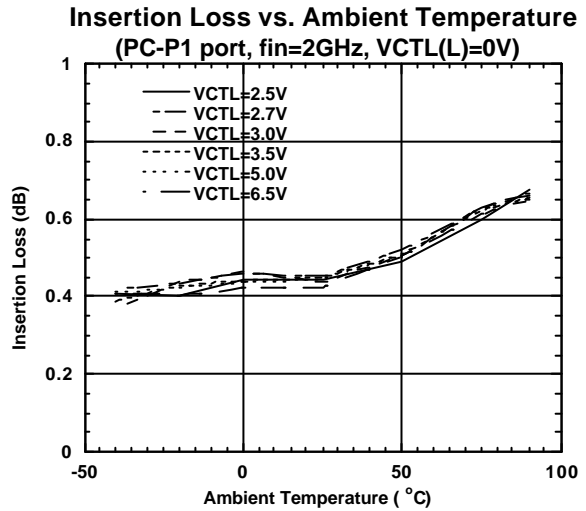
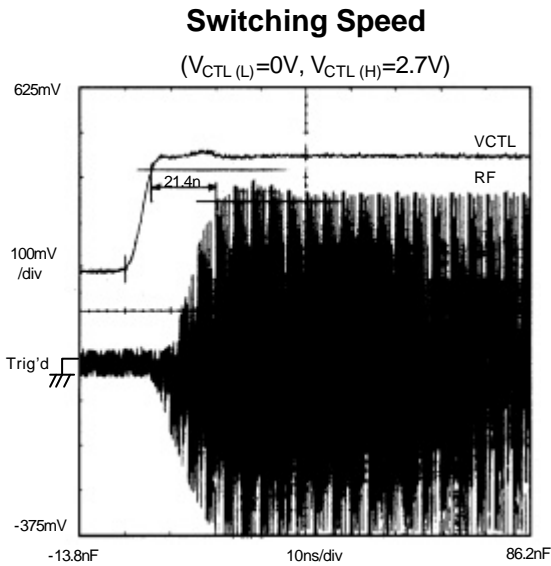
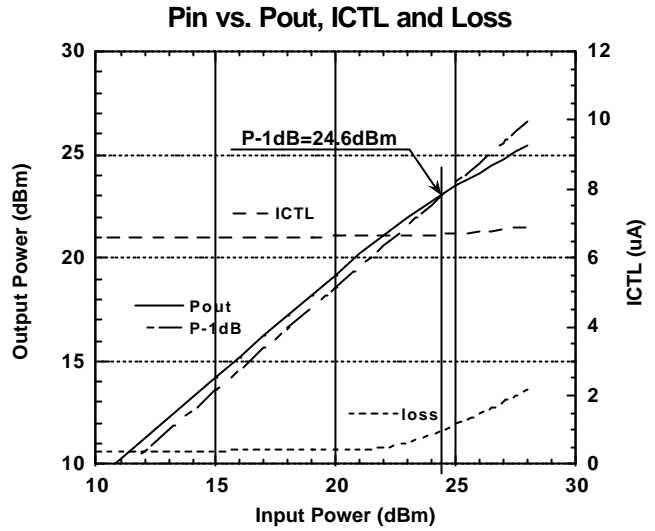
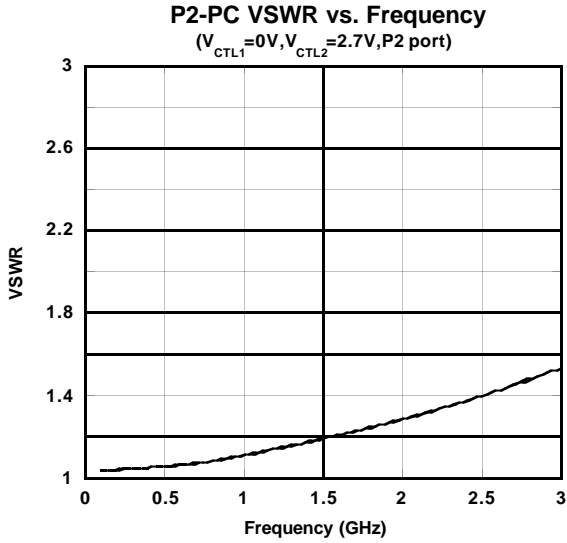

# NJG1522KB2

## ELECTRICAL CHARACTERISTICS

(f=50~100MHz, with Application circuit (Parts list 1), Losses of PCB, connector and DC blocking capacitor are included)

**PC-P1 Insertion Loss vs. Frequency**

( $V_{CTL1}=2.7V, V_{CTL2}=0V, Pin=0dBm$ )

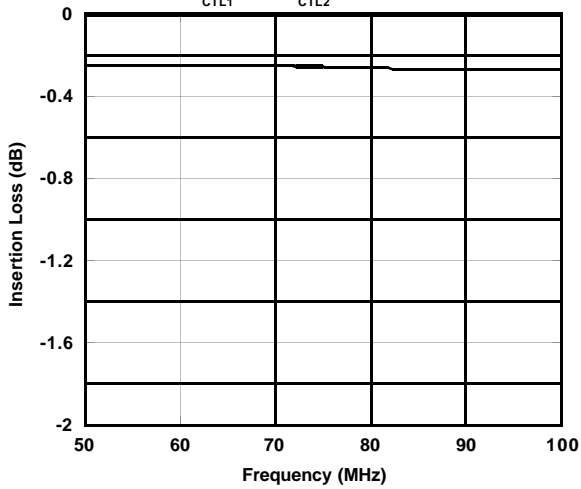

**PC-P2 Insertion Loss vs. Frequency**

( $V_{CTL1}=0V, V_{CTL2}=2.7V, Pin=0dBm$ )

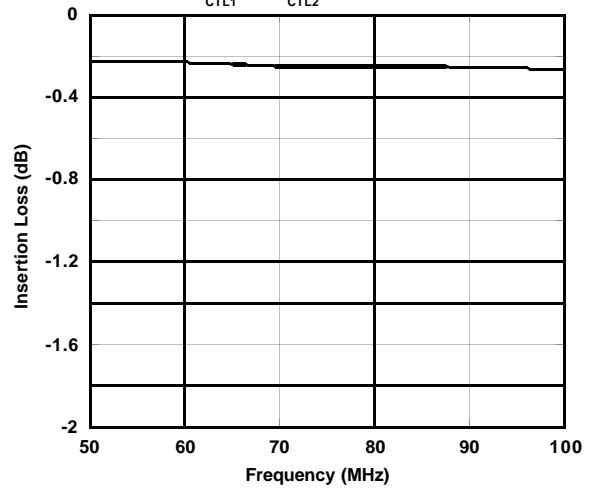

**PC-P1 Isolation vs. Frequency**

( $V_{CTL1}=0V, V_{CTL2}=2.7V, Pin=0dBm$ )

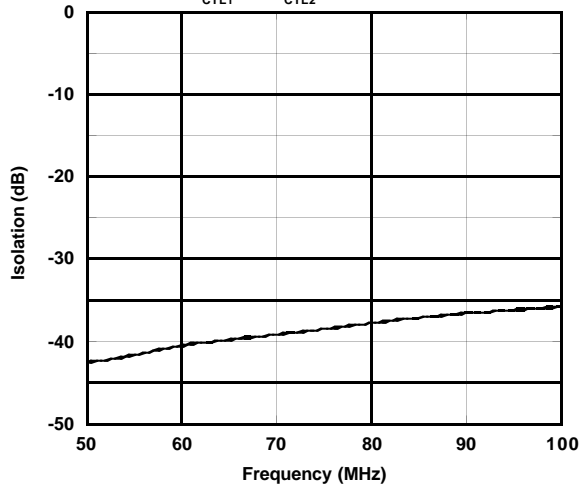

**PC-P2 Isolation vs. Frequency**

( $V_{CTL1}=2.7V, V_{CTL2}=0V, Pin=0dBm$ )

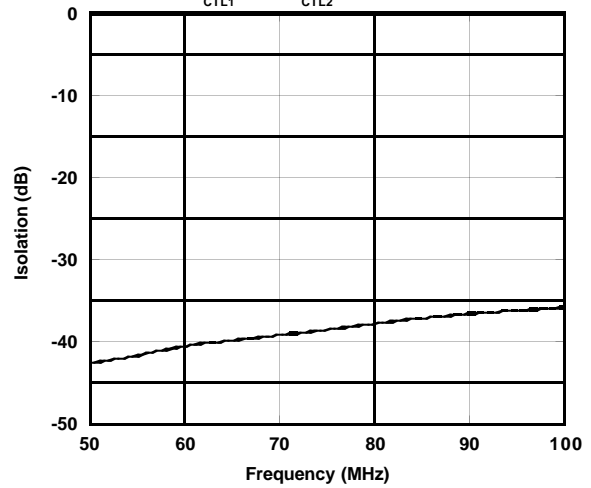

**PC-P1 VSWR vs. Frequency**

( $V_{CTL1}=2.7V, V_{CTL2}=0V, PC \text{ port}$ )

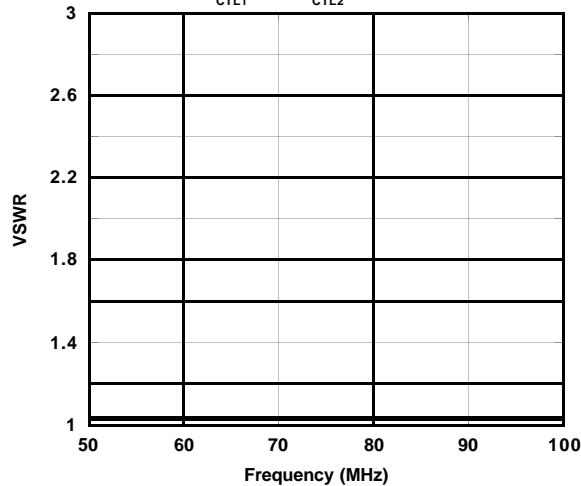

**P1-PC, P2-PC VSWR vs. Frequency**

( $V_{CTL1}=2.7V, V_{CTL2}=0V, P1 \text{ port}$ )

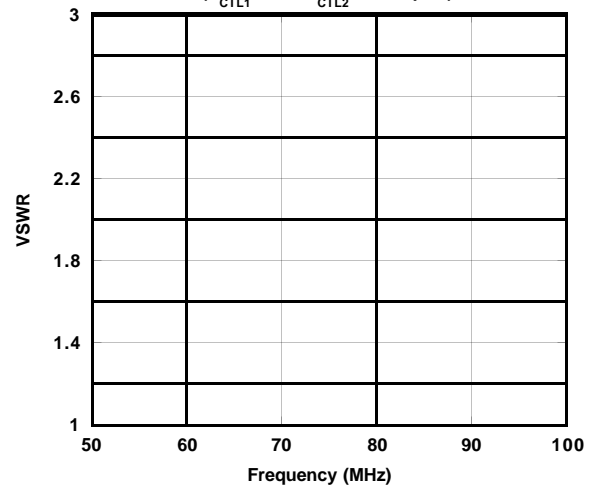

## ■ ELECTRICAL CHARACTERISTICS

(f=100~500MHz, with Application circuit (Parts list 2), Losses of PCB, connector and DC blocking capacitor are included)

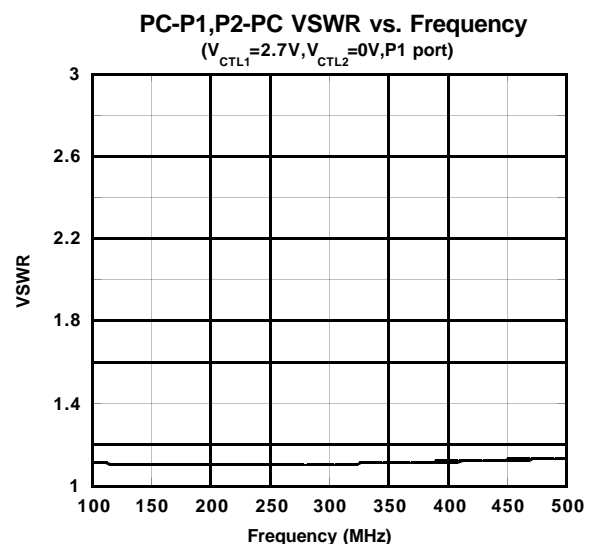
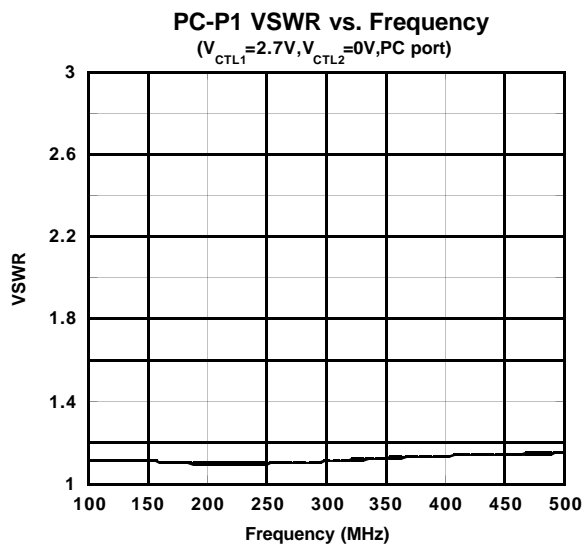
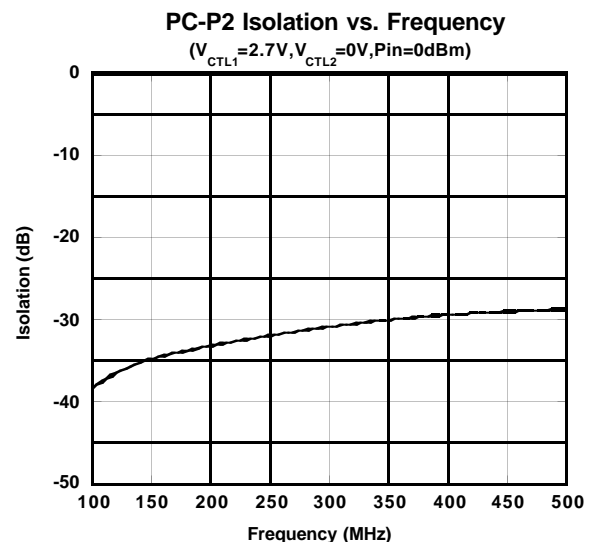
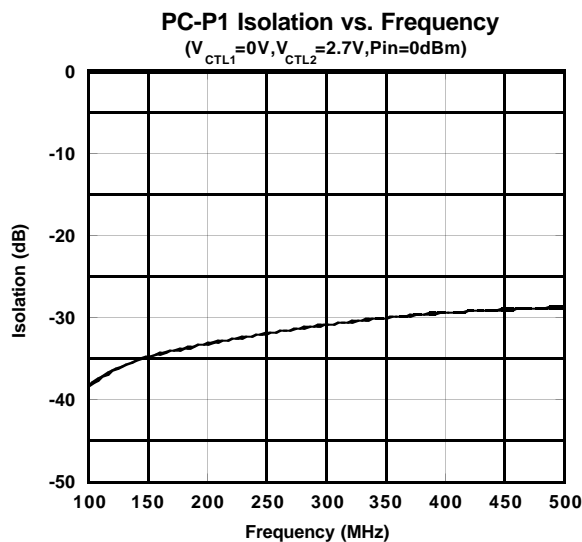
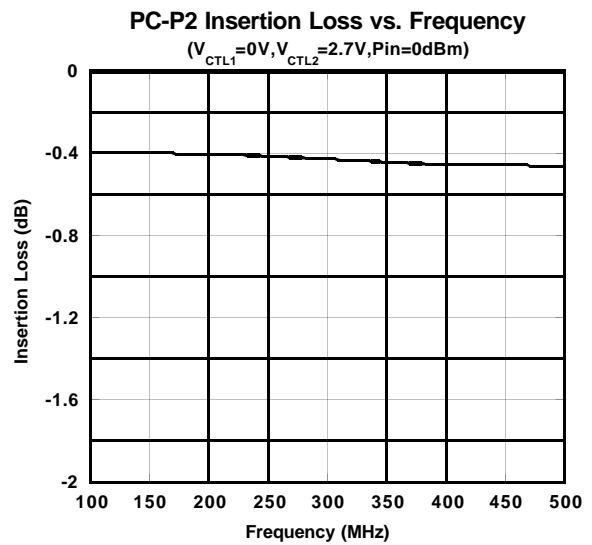
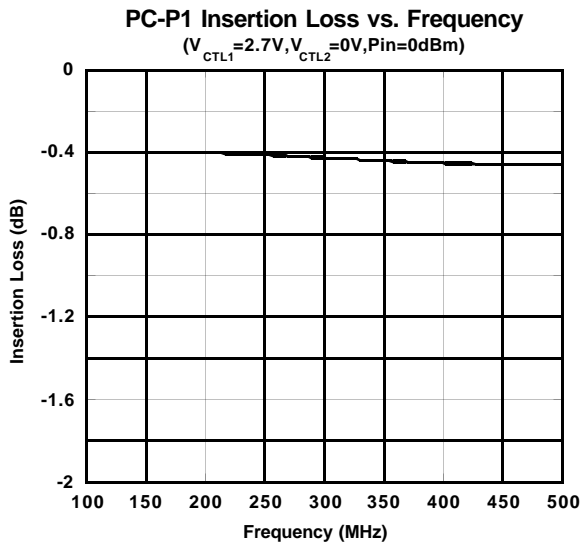

# NJG1522KB2

## ELECTRICAL CHARACTERISTICS

(f=0.1~3.0GHz, with Application circuit (Parts list 3), Losses of PCB, connector and DC blocking capacitor are included)

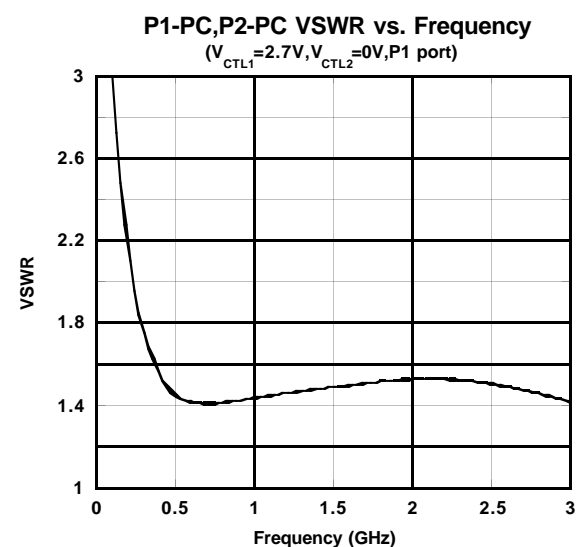
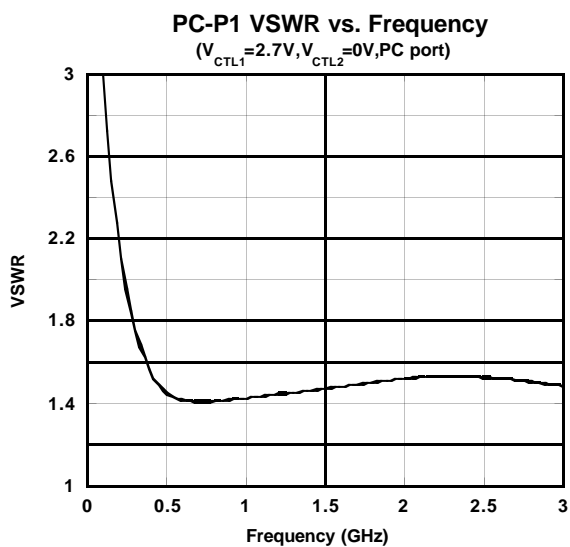
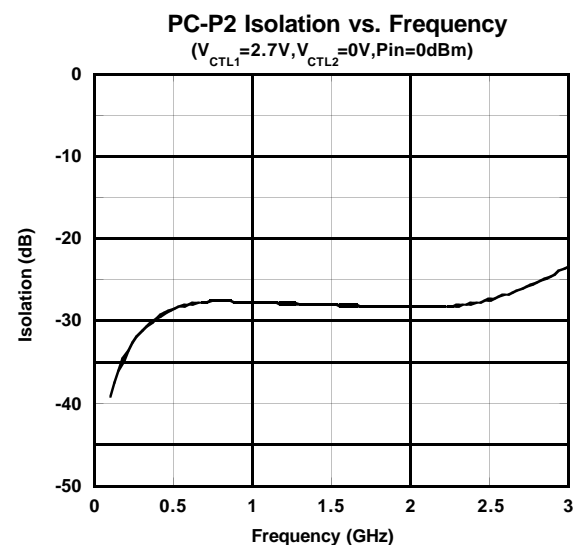
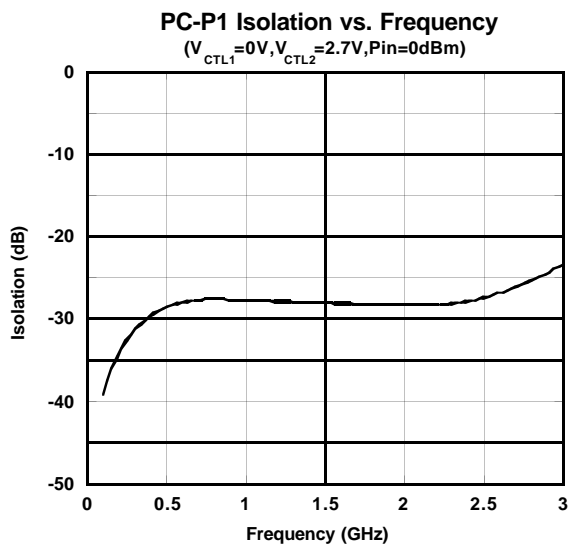
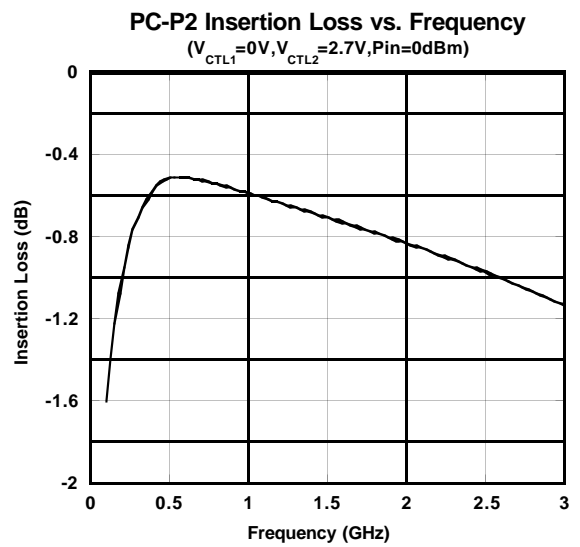
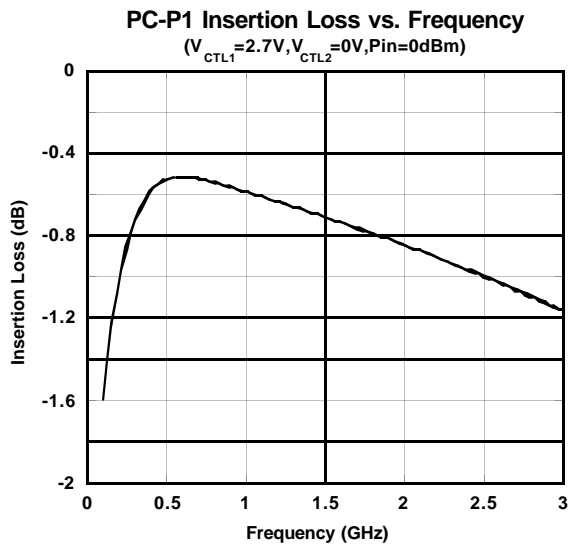

## ■ ELECTRICAL CHARACTERISTICS

(Losses of PCB, connector and DC blocking capacitor at each frequency.)

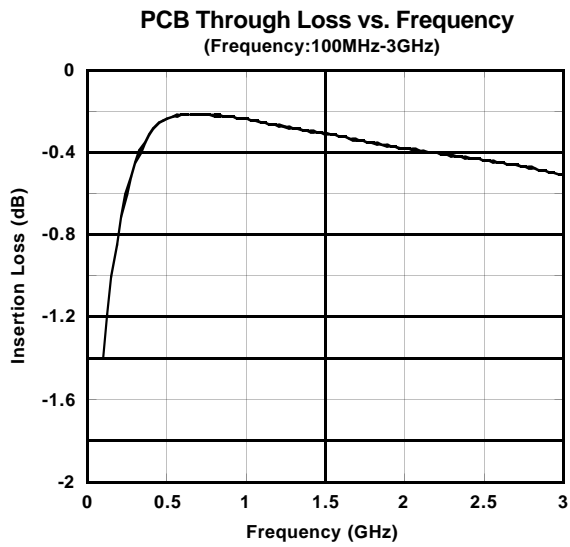
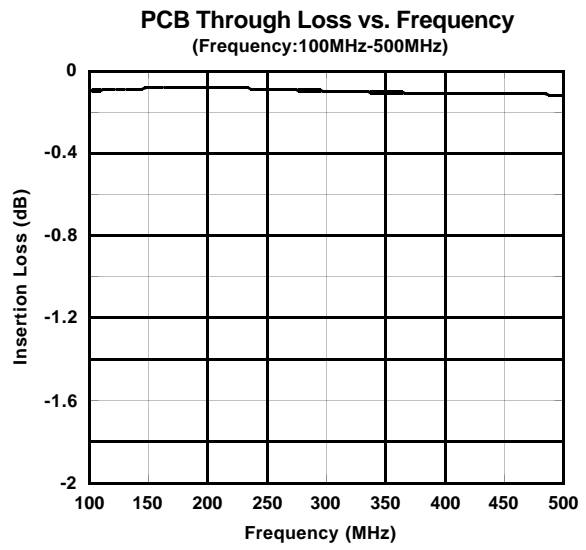
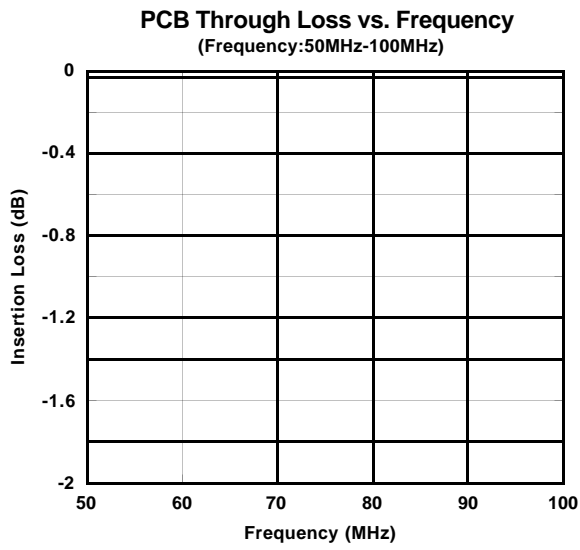

# NJG1522KB2

## APPLICATION CIRCUIT

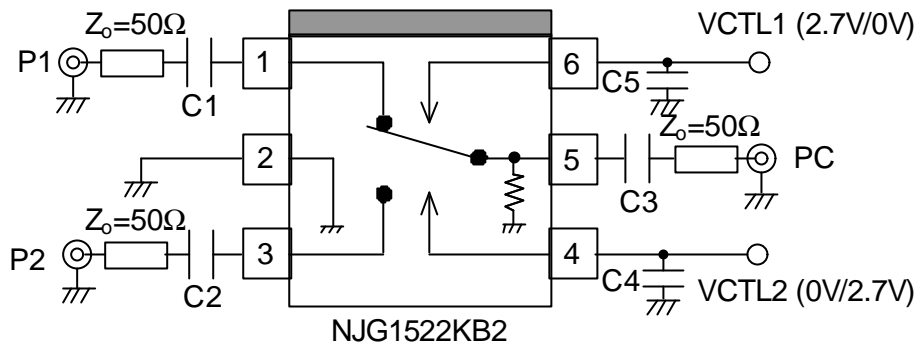

### Parts List

Parts number	List 1	List 2	List 3	Notes
	50~100MHz	0.1~0.5GHz	0.5~2.5GHz	
C1~C3	0.01uF	1000pF	56pF	GRM36 MURATA
C4, C5	10pF	10pF	10pF	GRM36 MURATA

## RECOMMENDED PCB DESIGN

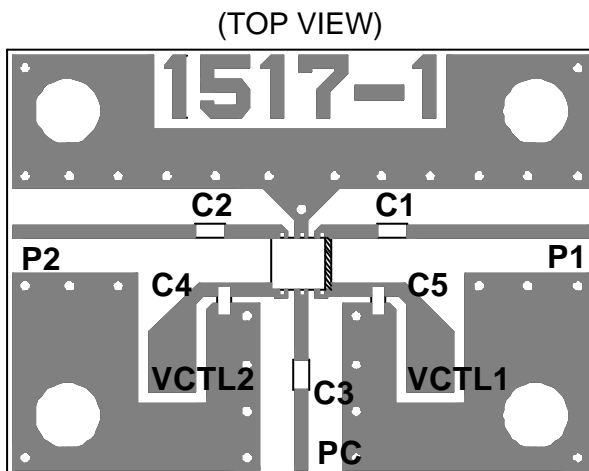

PCB SIZE=19.4x14.0mm  
 PCB: FR-4, t=0.2mm  
 CAPACITOR: size 1005  
 STRIPLINE WIDTH=0.4mm

## PRECAUTIONS

- [1]The DC blocking capacitors have to be placed at RF terminal of P1, P2 and PC. Please choose appropriate capacitance values to the application frequency.
- [2]To reduce stripline influence on RF characteristics, please locate bypass capacitors(C4, C5) close to each terminals.
- [3]For good isolation, the GND terminal (2<sup>nd</sup> pin) must be placed possibly close to ground plane of substrate, and through holes for GND should be placed near by the pin connection.

## PACKAGE OUTLINE

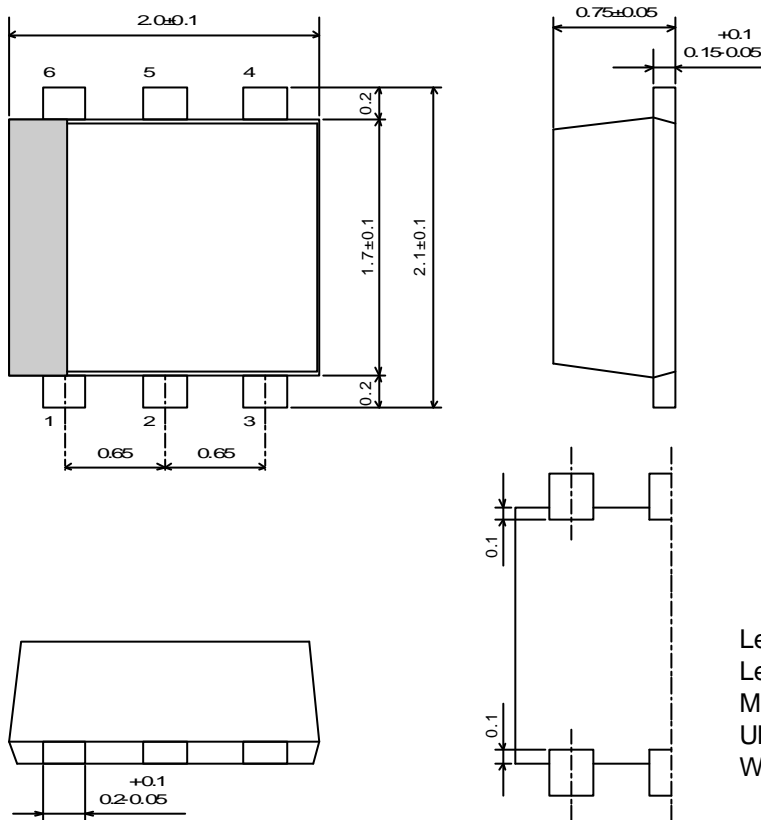

Lead material : Copper  
 Lead surface finish : Solder plating  
 Molding material : Epoxy resin  
 UNIT : mm  
 Weight : 6.5mg

### Cautions on using this product

This product contains Gallium-Arsenide (GaAs) which is a harmful material.

- Do NOT eat or put into mouth.
- Do NOT dispose in fire or break up this product.
- Do NOT chemically make gas or powder with this product.
- To waste this product, please obey the relating law of your country.

### [CAUTION]

The specifications on this databook are only given for information, without any guarantee as regards either mistakes or omissions. The application circuits in this databook are described only to show representative usages of the product and not intended for the guarantee or permission of any right including the industrial rights.

This product may be damaged with electric static discharge (ESD) or spike voltage. Please handle with care to avoid these damages.

## Looking for pricing, stock, or lifecycle information?

Click below to explore more details on WIN SOURCE:

- [View NJG1522KB2-TE1# on WIN SOURCE](#)
- [NJR Corporation/NJRC Information](#)

## Optimize Your Supply Chain with WIN SOURCE Solutions

- ✓ Global Sourcing Solution
- ✓ Obsolete Management
- ✓ Cost Control Management
- ✓ Shortage Management
- ✓ Alternative Solution
- ✓ Excess Inventory Management