



**THE DATASHEET OF
NJG1507R(TE1)**



SPDT SWITCH GaAs MMIC

■GENERAL DESCRIPTION

NJG1507R is a GaAs SPDT switch IC which exhibits low loss and high isolation, and ideally suitable for T/R switch of the digital wireless phone.

This switch is operated in the wide frequency range from 50MHz to 3.0GHz at low operating voltage from +2.5V with small VSP8 package.

■PACKAGE OUTLINE

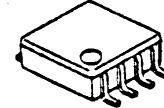

NJG1507R

■FEATURES

- Single and low positive supply voltage +2.5~+5.5V
- Low insertion loss 0.5dB typ. @ f=2GHz, P_{in}=22dBm
- Transmission power 27dBm max. @ f=2GHz, V_{CTL}=3.0V
- High isolation 33dB typ. @ f=2GHz, P_{in}=22dBm
- Low control current 5uA typ. @ f=0.05~2.5GHz, P_{in}=22dBm
- Package VSP8 (Mount Size: 4.0x2.9x1.2mm)

■PIN CONFIGURATION

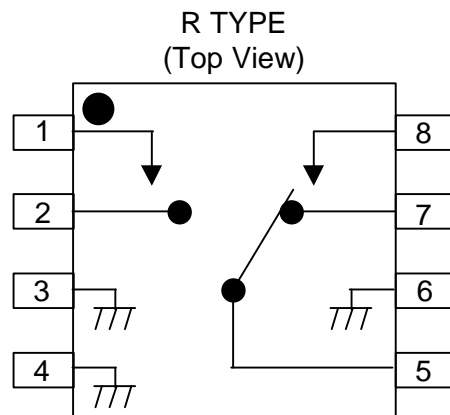

Pin Connection

- 1.V_{CTR2}
- 2.P2
- 3.GND
- 4.GND
- 5.PC
- 6.GND
- 7.P1
- 8.V_{CTR1}

■TRUTH TABLE

“H”=V_{CTR (H)}, “L”=V_{CTR (L)}

V _{CTR1}	H	L	L	H
V _{CTR2}	L	H	L	H
P1-PC	OFF	ON	Loss =15dB P ₁ Return Loss =-3dB	Loss =16dB P ₁ Return Loss =-2dB
P2-PC	ON	OFF	Loss =15dB P ₂ Return Loss =-3dB	Loss =16dB P ₂ Return Loss =-2dB

Note) The values of "Loss" and "Return Loss" are typical values at 2.0GHz.

NJG1507R

■ABSOLUTE MAXIMUM RATINGS

($T_a=25^{\circ}\text{C}$, $Z_s=Z_l=50\Omega$)

PARAMETER	SYMBOL	RATINGS	UNITS
Input power	P_{in}	33	dBm
Control voltage	V_{CTR}	6.0	V
Power dissipation	P_D	320	mW
Operating Temp.	T_{opr}	-30~+85	$^{\circ}\text{C}$
Storage Temp.	T_{stg}	-40~+150	$^{\circ}\text{C}$

■ELECTRICAL CHARACTERISTICS

($V_{CTR(L)}=0\text{V}$, $V_{CTR(H)}=2.7\text{V}$, $Z_s=Z_o=50\Omega$, $T_a=25^{\circ}\text{C}$)

PARAMETER	SYMBOL	CONDITIONS	MIN	TYP	MAX	UNITS
Control voltage (L)	$V_{CTR(L)}$	$f=0.05\sim 2.5\text{GHz}$, $P_{in}=22\text{dBm}$	-0.2	0	0.2	V
Control voltage (H)	$V_{CTR(H)}$	$f=0.05\sim 2.5\text{GHz}$, $P_{in}=22\text{dBm}$	2.5	2.7	5.5	V
Control current	I_{CTR}	$f=0.05\sim 2.5\text{GHz}$, $P_{in}=22\text{dBm}$	-	5.0	8.0	μA
Insertion loss1	LOSS1	$f=1.0\text{GHz}$, $P_{in}=22\text{dBm}$	-	0.4	0.7	dB
Insertion loss2	LOSS2	$f=2.0\text{GHz}$, $P_{in}=22\text{dBm}$	-	0.5	0.8	dB
Isolation 1 (PC-P1, PC-P2, P1-P2)	ISL1	$f=1.0\text{GHz}$, $P_{in}=22\text{dBm}$	25	31	-	dB
Isolation 2 (PC-P1, PC-P2, P1-P2)	ISL2	$f=2.0\text{GHz}$, $P_{in}=22\text{dBm}$	25	33	-	dB
Pin at 1dB compression point 1	$P_{-1\text{dB}(1)}$	$f=2.0\text{GHz}$	26	28	-	dBm
Pin at 1dB compression point 2	$P_{-1\text{dB}(2)}$	$V_{CTR(H)}=3.0\text{V}$, $f=2.0\text{GHz}$	27	30	-	dBm
VSWR	VSWR	$f=0.05\sim 2.5\text{GHz}$, ON STATE	-	1.2	1.5	
Switching time	T_{SW}	$f=0.05\sim 2.5\text{GHz}$	-	15	-	ns

■ TYPICAL CHARACTERISTICS

(PC-P1) Insertion loss vs. Frequency
 ($V_{cTX}=0V/2.7V$, $P_{iA}=22dBm$)

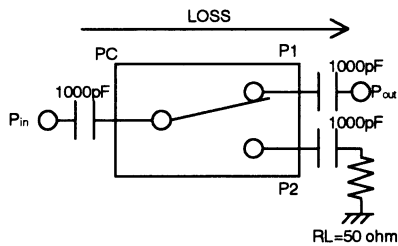
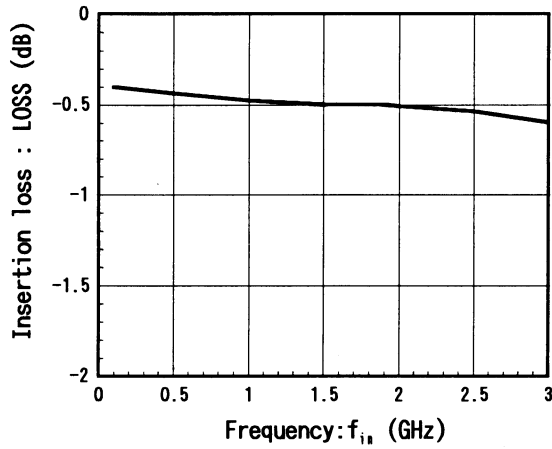

(PC-P2) Insertion loss vs. Frequency
 ($V_{cTX}=0V/2.7V$, $P_{iA}=22dBm$)

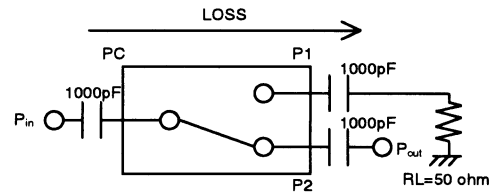
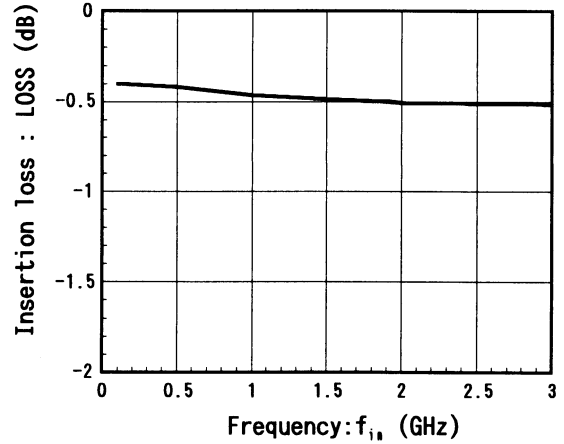

(PC-P1) Isolation vs. Frequency
 ($V_{cTX}=0V/2.7V$, $P_{iA}=22dBm$)

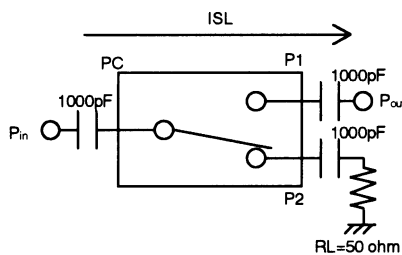
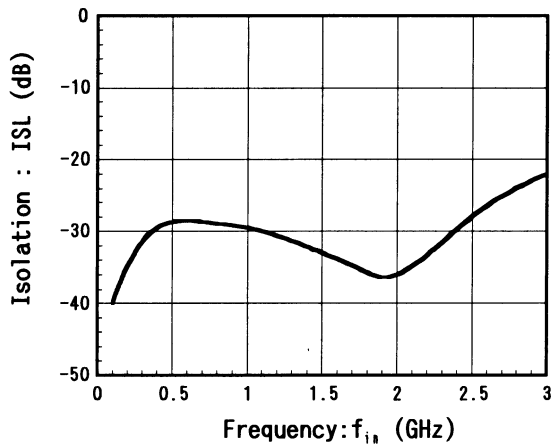

(PC-P2) Isoaltion vs. Frequency
 ($V_{cTX}=0V/2.7V$, $P_{iA}=22dBm$)

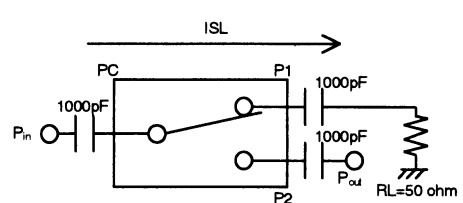
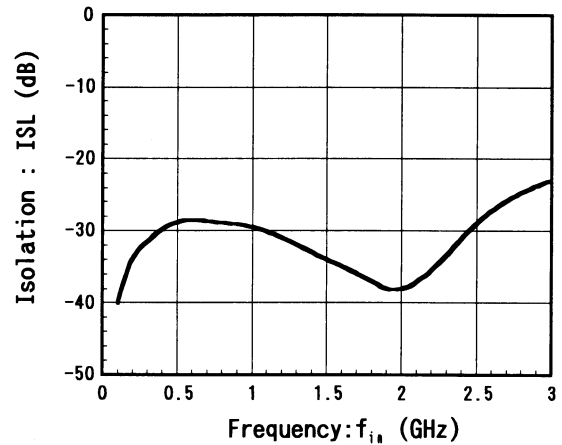

NJG1507R

TYPICAL CHARACTERISTICS

P1-PC(ON) V.S.W.R vs. Frequency

($V_{CT1}=0V/2.7V$, $P_{i1}=0dBm$)

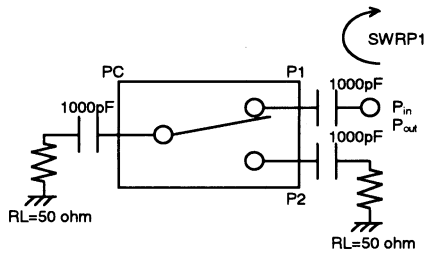
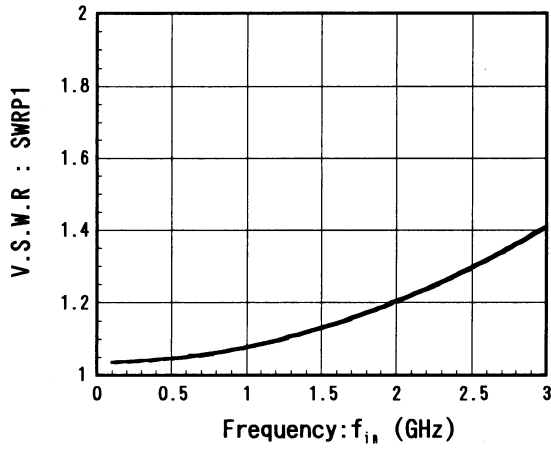

PC-P2(ON) V.S.W.R vs. Frequency

($V_{CT1}=0V/2.7V$, $P_{i1}=0dBm$)

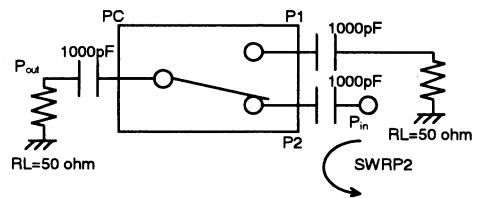
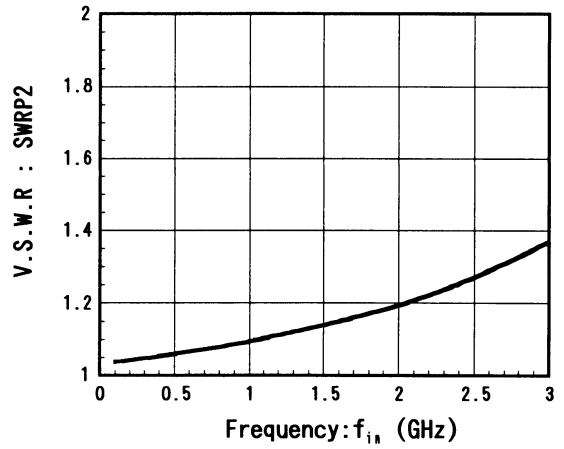

PC-P1(ON) V.S.W.R vs. Frequency

($V_{CT1}=0V/2.7V$, $P_{i1}=0dBm$)

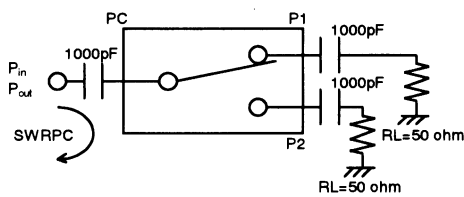
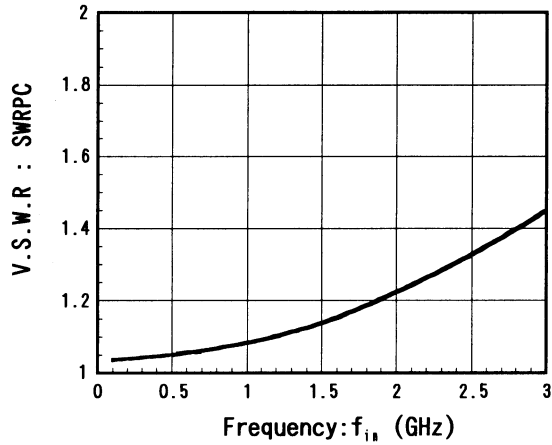

TYPICAL CHARACTERISTICS

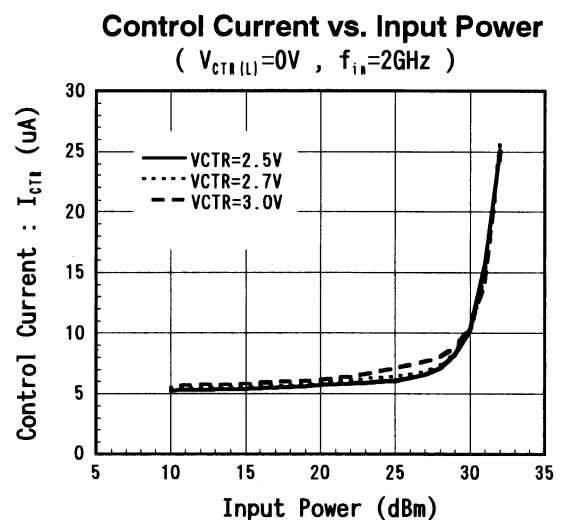
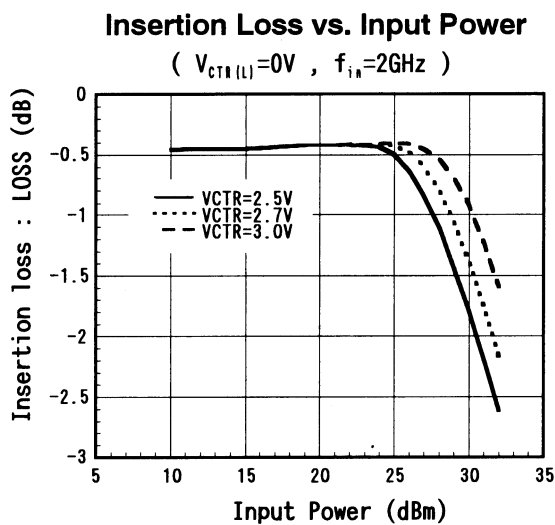
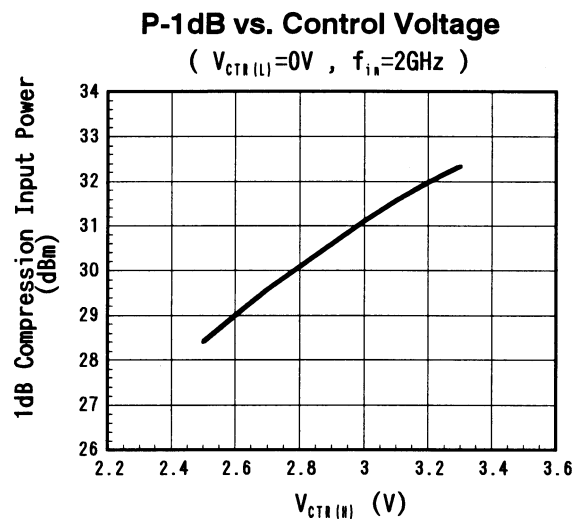
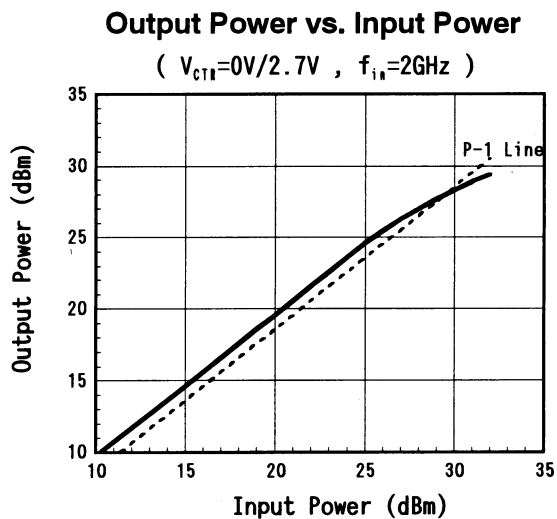
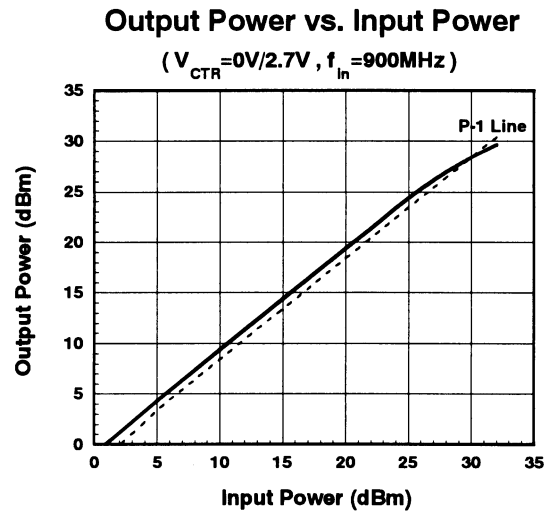
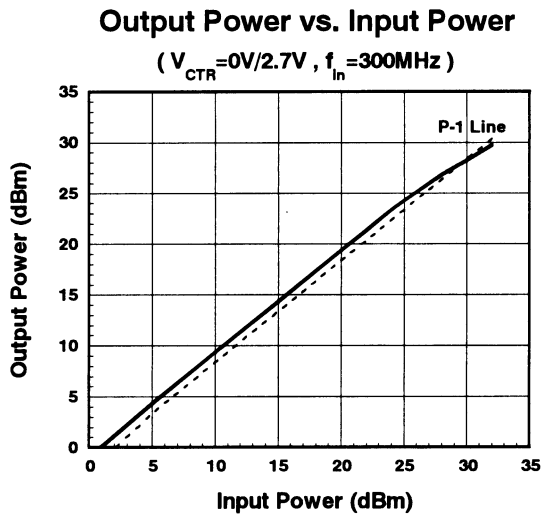

NJG1507R

TYPICAL CHARACTERISTICS

Loss/Isolation vs. Temperature

($V_{CTR} = 0V/2.7V$, $f_{in} = 2GHz$)

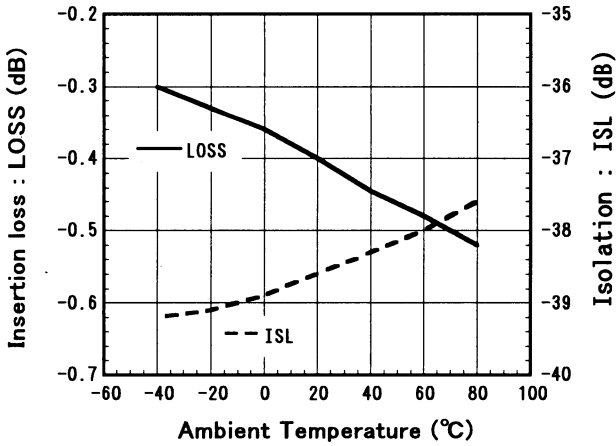

P-1dB vs. Temperature

($V_{CTR(L)} = 0V$, $f_{in} = 2GHz$)

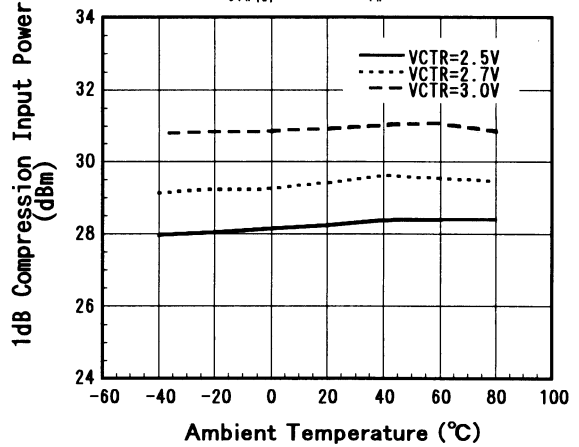

600kHz ACP vs. Temperature

($V_{CTR(L)} = 0V$, $f_{in} = 1.9GHz$, $P_{in} = 22dBm$)

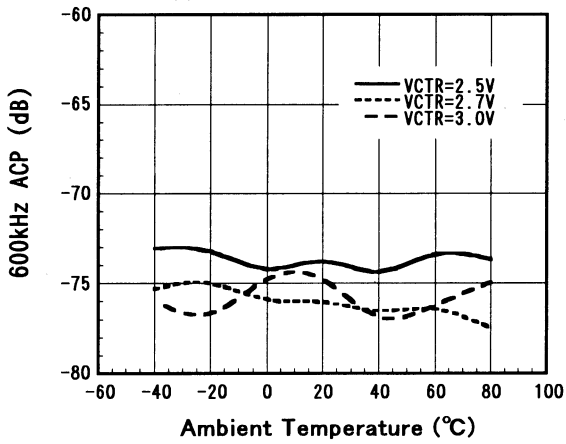

Control Current vs. Temperature

($V_{CTR(L)} = 0V$, $f_{in} = 2GHz$, $P_{in} = 22dBm$)

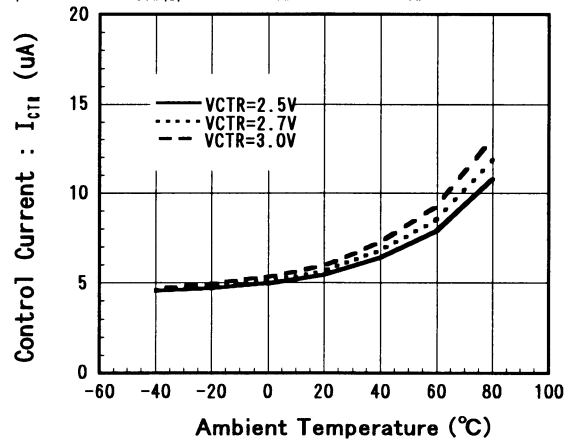

■ TYPICAL CHARACTERISTICS

600kHz ACP (Ta=25°C)
 DQPSK Modulation Signal (without D.U.T)
 f_{in}=1.9GHz P_{in}=22dBm
 MODULATION: 384Kbps RNYQ α=0.5 1/4 π DQPSK

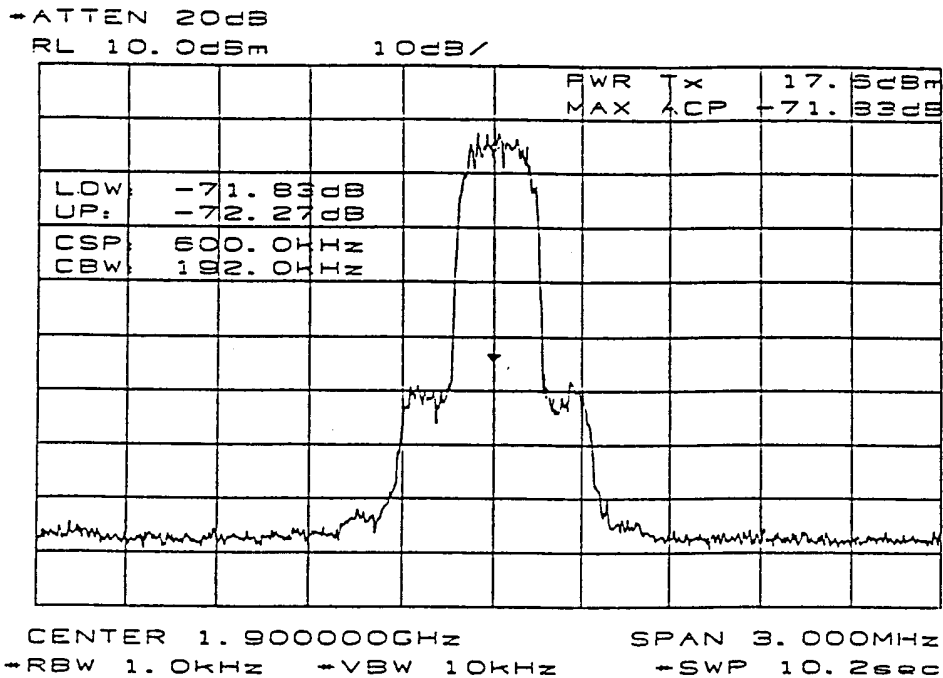

D.U.T Output Signal
 Insertion PORT: PC → P1
 f_{in}=1.9GHz P_{in}=22dBm V_{CTR}=0/2.7V
 MODULATION: 384Kbps RNYQ α=0.5 1/4 π DQPSK

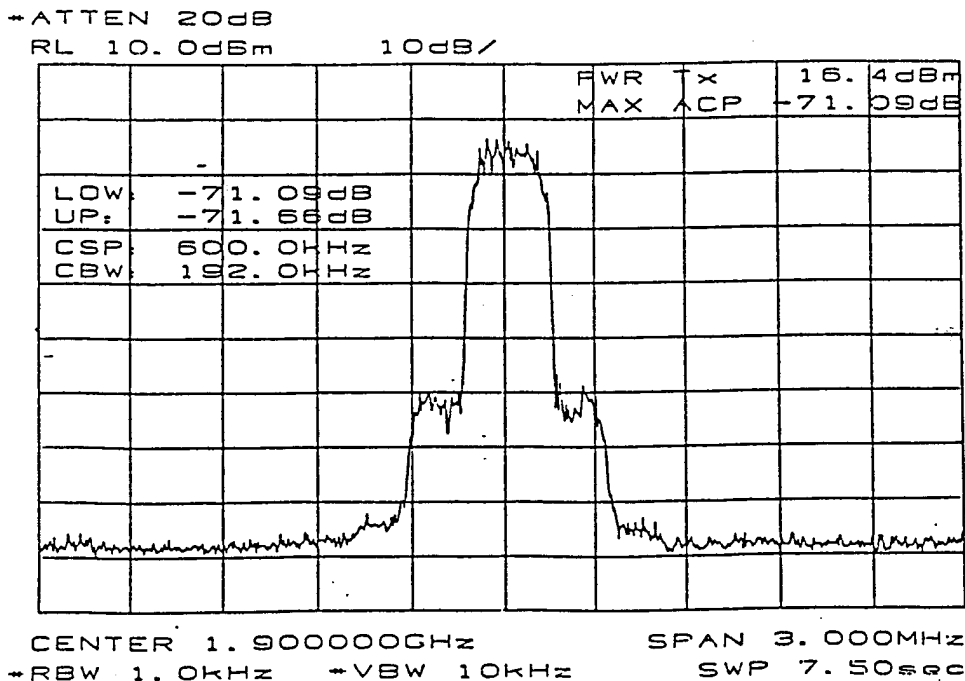

■ TYPICAL CHARACTERISTICS

P1 PORT IMPEDANCE (OFF STATE)

REF 1.0 Units
 S 200.0 mUnits/
 V 292.59 Ω -71.453 Ω

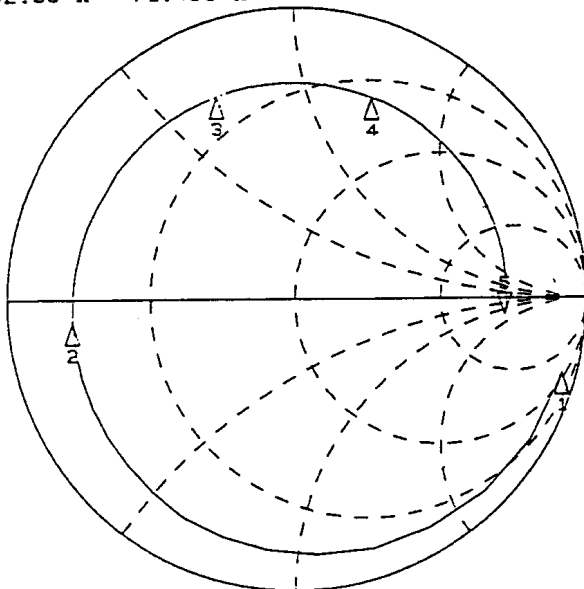

START 0.050000000 GHz
 STOP 3.000000000 GHz

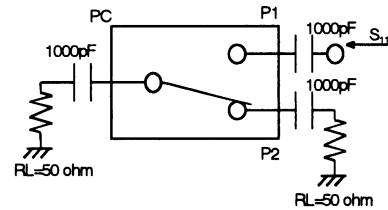

MARKER	f(MHz)	Mag.	Ang. (∠°)
1	50	0.952	-15.9
2	800	0.780	-171.0
3	1500	0.740	117.0
4	2000	0.726	75.8
5	3000	0.698	1.2

P2 PORT IMPEDANCE (OFF STATE)

REF 1.0 Units
 S 200.0 mUnits/
 V 280.78 Ω 15.5 Ω

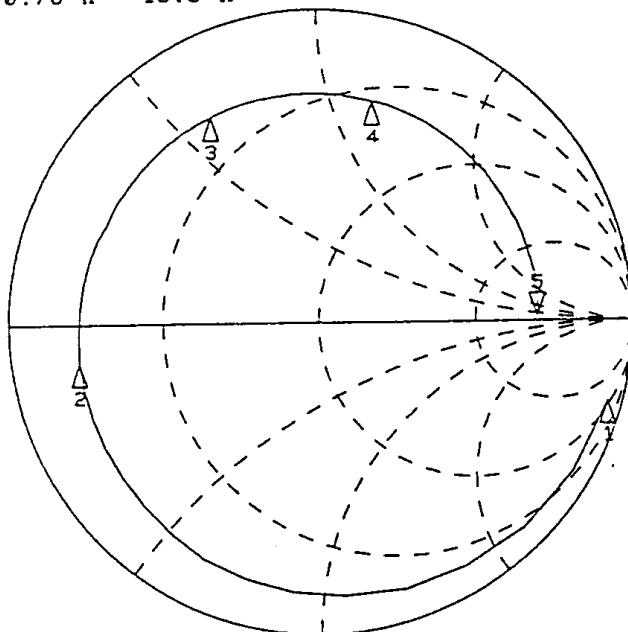

START 0.050000000 GHz
 STOP 3.000000000 GHz

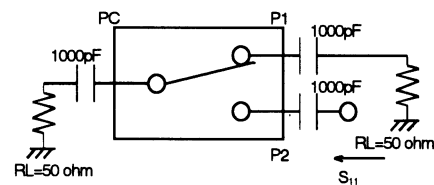

MARKER	f(MHz)	Mag.	Ang. (∠°)
1	50	0.952	-15.9
2	800	0.780	-171.0
3	1500	0.740	117.0
4	2000	0.726	75.8
5	3000	0.698	1.2

■TYPICAL CHARACTERISTICS

Scattering Parameters: S11 (OFF STATE)

($V_{CTR}=0/2.7V$, 50Ω System)

f(MHz)	P1 PORT		P2 PORT	
	Mag.	Ang.(\angle°)	Mag.	Ang.(\angle°)
50	0.951	-15.8	0.952	-15.9
100	0.941	-30.9	0.938	-31.0
200	0.911	-59.2	0.911	-59.2
300	0.879	-84.9	0.877	-84.6
400	0.849	-107.4	0.850	-106.7
500	0.823	-127.2	0.824	-126.0
600	0.803	-144.6	0.805	-142.8
700	0.787	-160.1	0.791	-157.6
800	0.777	-174.1	0.780	-171.0
900	0.768	173.1	0.770	176.8
1000	0.761	161.2	0.763	165.5
1100	0.750	149.6	0.749	154.2
1200	0.751	139.8	0.749	144.7
1300	0.748	129.7	0.745	135.1
1400	0.748	120.1	0.744	125.9
1500	0.745	110.9	0.740	117.0
1600	0.746	102.1	0.737	108.5
1700	0.743	93.6	0.732	100.3
1800	0.742	85.1	0.732	91.9
1900	0.740	76.9	0.728	83.7
2000	0.739	68.9	0.726	75.8
2100	0.740	61.3	0.725	68.3
2200	0.739	53.3	0.723	60.5
2300	0.735	45.8	0.718	52.7
2400	0.735	38.4	0.717	45.2
2500	0.736	30.8	0.714	37.7
2600	0.732	23.8	0.711	30.5
2700	0.734	17.0	0.708	23.4
2800	0.729	9.5	0.706	15.8
2900	0.727	2.5	0.703	8.6
3000	0.721	-4.6	0.698	1.2

■ **APPLICATION CIRCUIT 1:** Single control signal operation by using C-MOS inverter.

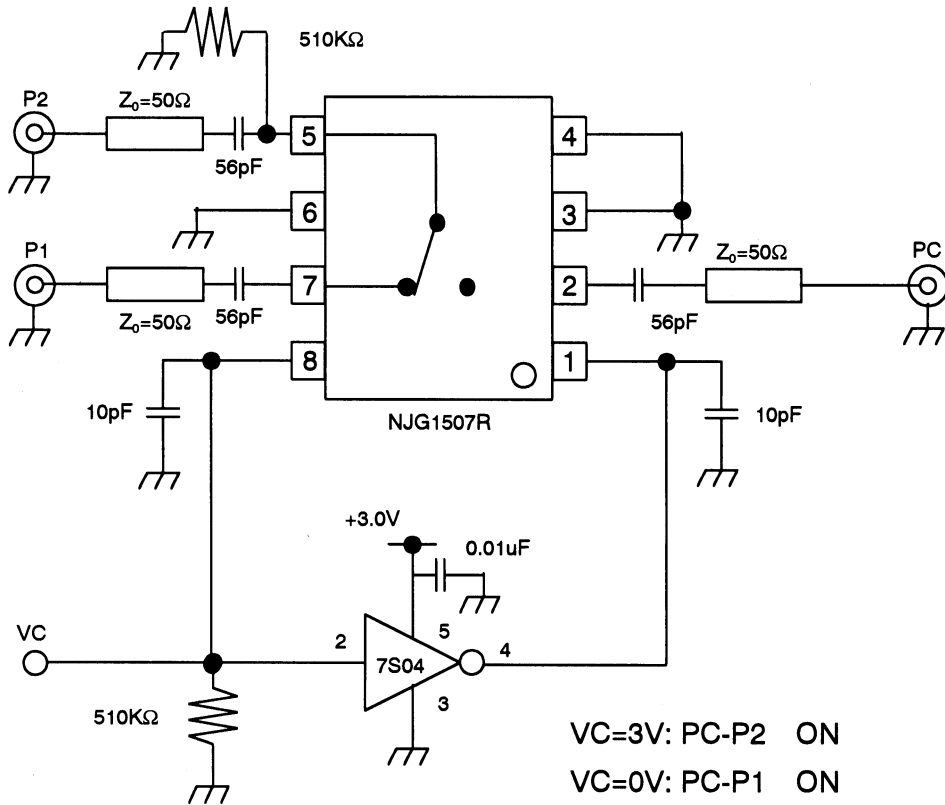

- [1] Please connect bypass capacitors to the supply terminals of the C-MOS inverter.
- [2] In order to stabilize input impedance of inverter, please pull down using 510KΩ resistor from the input terminal of the C-MOS inverter to the ground plane.

■ **APPLICATION CIRCUIT 2:** Single control signal operation by using a transistor.

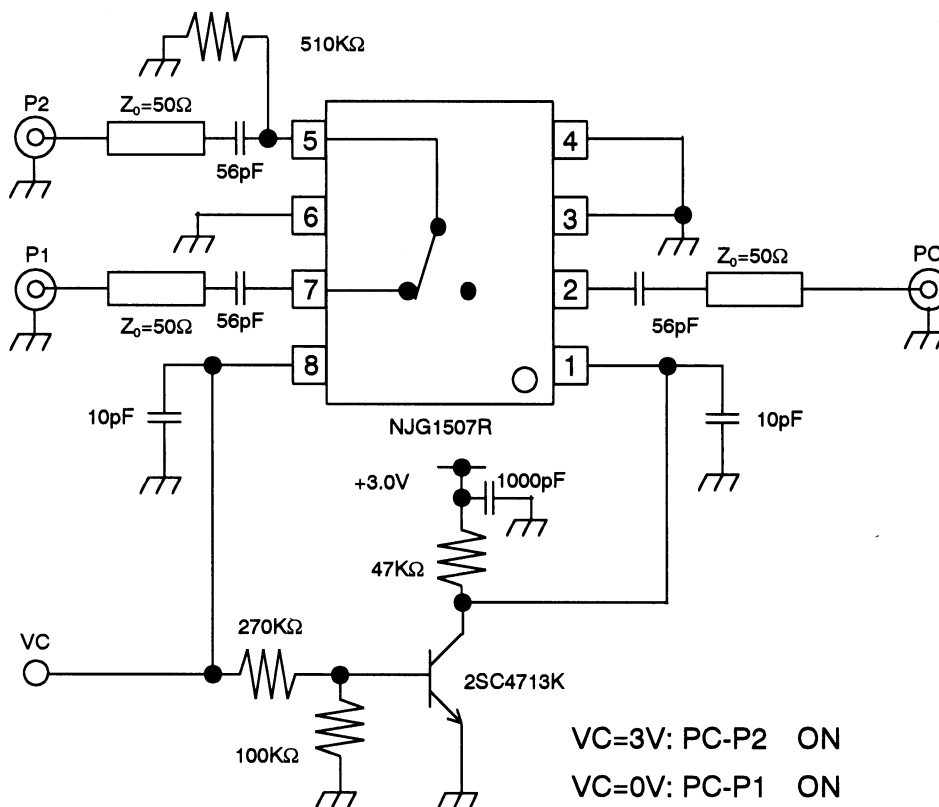

NJG1507R

TEST CIRCUIT

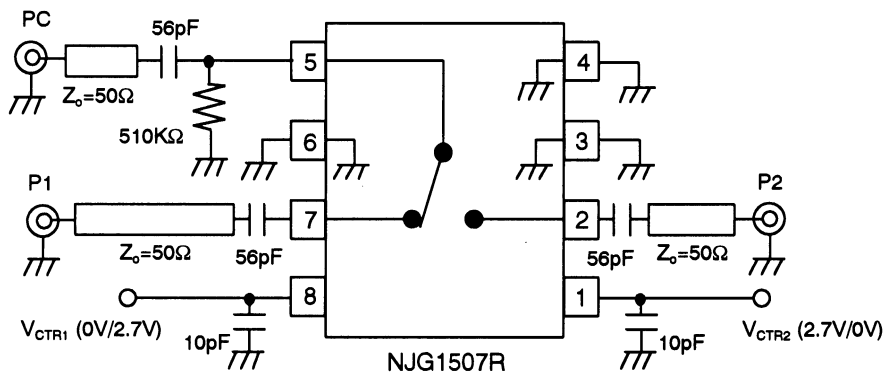

RECOMMENDED PCB DESIGN

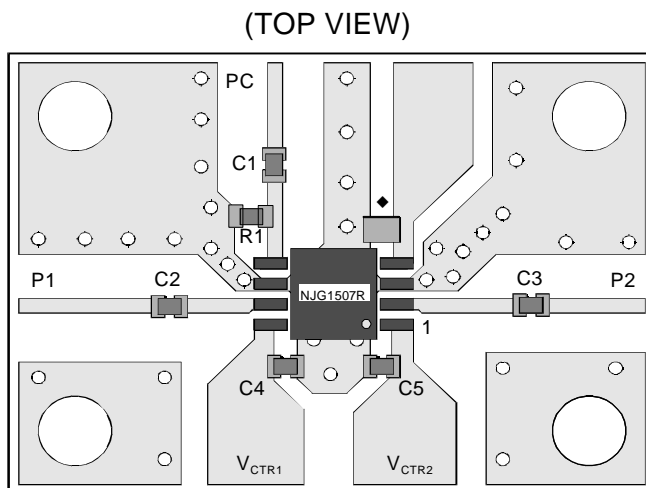

PCB SIZE=19.5x14.0mm

PCB: FR-4, t=0.2mm

CAPACITOR: size 1005

STRIPLINE WIDTH=0.5mm

C1~C3: 56pF

C4, C5: 10pF

R1: 510KΩ

◆: Please short between Pin4 and ground plane directly as close as possible.

Precautions

- [1] External capacitors should be connected to the input and output RF terminals (P1, P2, PC) to block the DC current. The above example is a circuit at 1.9GHz. Please select the capacitor value suitable for actual frequency from 10pF to 1000pF.
- [2] Decoupling capacitors should be connected to the control terminals (V_{CTR1} , V_{CTR2}) as close as possible. The values of these capacitors should be selected from 5pF to 100pF range. Please consider that these values are very effective to switching time (Larger capacitor gives longer switching time).
- [3] In order to keep good isolation characteristics, the ground terminals (3, 4, 6pin) should be connected to the ground pattern with wider width as close as possible, and through-hole in the ground plane should also be placed as close as possible.

PACKAGE OUTLINE (VSP8)

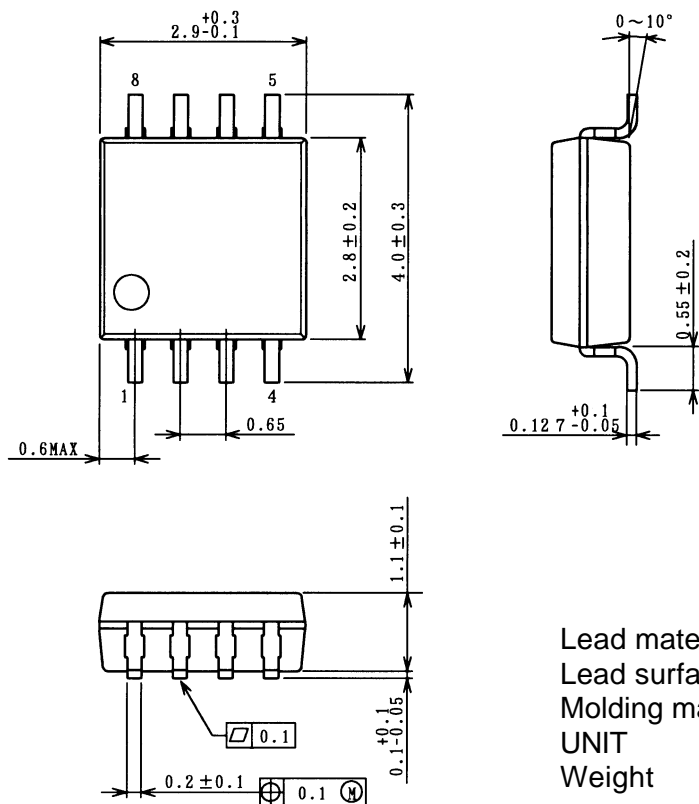

Lead material : Copper
 Lead surface finish : Solder plating
 Molding material : Epoxy resin
 UNIT : mm
 Weight : 22mg

Cautions on using this product

This product contains Gallium-Arsenide (GaAs) which is a harmful material.

- Do NOT eat or put into mouth.
- Do NOT dispose in fire or break up this product.
- Do NOT chemically make gas or powder with this product.
- To waste this product, please obey the relating law of your country.



[CAUTION]

The specifications on this databook are only given for information, without any guarantee as regards either mistakes or omissions. The application circuits in this databook are described only to show representative usages of the product and not intended for the guarantee or permission of any right including the industrial rights.

This product may be damaged with electric static discharge (ESD) or spike voltage. Please handle with care to avoid these damages.

Looking for pricing, stock, or lifecycle information?

Click below to explore more details on WIN SOURCE:

-  [View NJG1507R\(TE1\) on WIN SOURCE](#)
-  [NJR Corporation/NJRC Information](#)

Optimize Your Supply Chain with WIN SOURCE Solutions

-  Global Sourcing Solution
-  Obsolete Management
-  Cost Control Management
-  Shortage Management
-  Alternative Solution
-  Excess Inventory Management