



**THE DATASHEET OF  
NCS2003SN2T1G**



# NCS2003/A, NCV2003, NCS20032, NCV20032, NCS20034, NCV20034

## Operational Amplifiers, High Slew Rate, Low Voltage, Rail-to-Rail Output

The NCS2003 family of op amps features high slew rate, low voltage operation with rail-to-rail output drive capability. The 1.8 V operation allows high performance operation in low voltage, low power applications. The fast slew rate and wide unity-gain bandwidth (5 MHz at 1.8 V) make these op amps suited for high speed applications. The low input offset voltage (4 mV max) allows the op amp to be used for current shunt monitoring. Additional features include no output phase reversal with overdriven inputs and ultra low input bias current of 1 pA.

The NCS2003 family is the ideal solution for a wide range of applications and products. The single channel NCS2003, dual channel NCS20032, and quad channel NCS20034 are available in a variety of compact and space-saving packages. The NCV prefix denotes that the device is AEC-Q100 Qualified and PPAP Capable.

### Features

- Unity Gain Bandwidth: 7 MHz at  $V_S = 5\text{ V}$
- Fast Slew Rate: 8 V/ $\mu\text{s}$  rising, 12.5 V/ $\mu\text{s}$  falling at  $V_S = 5\text{ V}$
- Rail-to-Rail Output
- No Output Phase Reversal for Over-Driven Input Signals
- Low Offset Voltage: 0.5 mV typical
- Low Input Bias Current: 1 pA typical
- NCV Prefix for Automotive and Other Applications Requiring Unique Site and Control Change Requirements; AEC-Q100 Qualified and PPAP Capable
- These Devices are Pb-Free, Halogen Free/BFR Free and are RoHS Compliant

### Applications

- Current Shunt Monitor
- Signal Conditioning
- Active Filter
- Sensor Buffer

### End Products

- Motor Control Drives
- Hard Drives
- Medical Devices
- White Goods and Air Conditioners



ON Semiconductor®

[www.onsemi.com](http://www.onsemi.com)

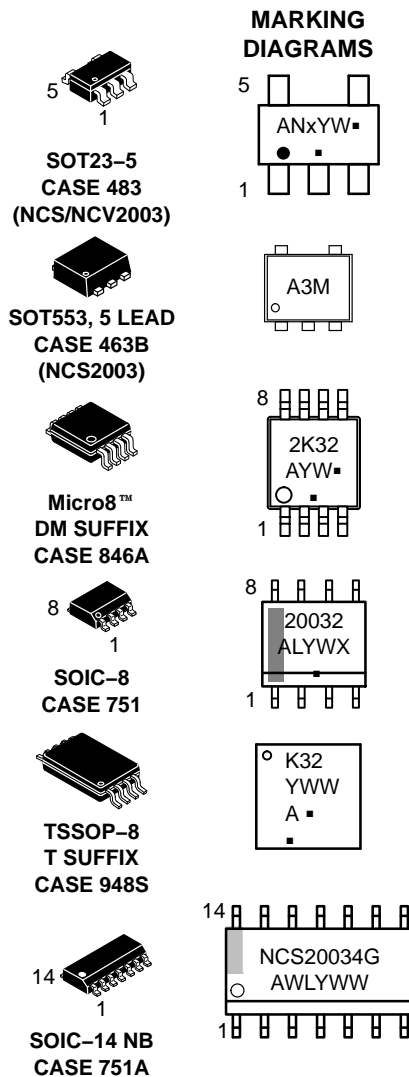

A = Assembly Location  
 WL, L = Wafer Lot  
 Y = Year  
 WW, W = Work Week  
 G or ■ = Pb-Free Package

(Note: Microdot may be in either location)

### ORDERING INFORMATION

See detailed ordering, marking and shipping information on page 2 of this data sheet.

# NCS2003/A, NCV2003, NCS20032, NCV20032, NCS20034, NCV20034

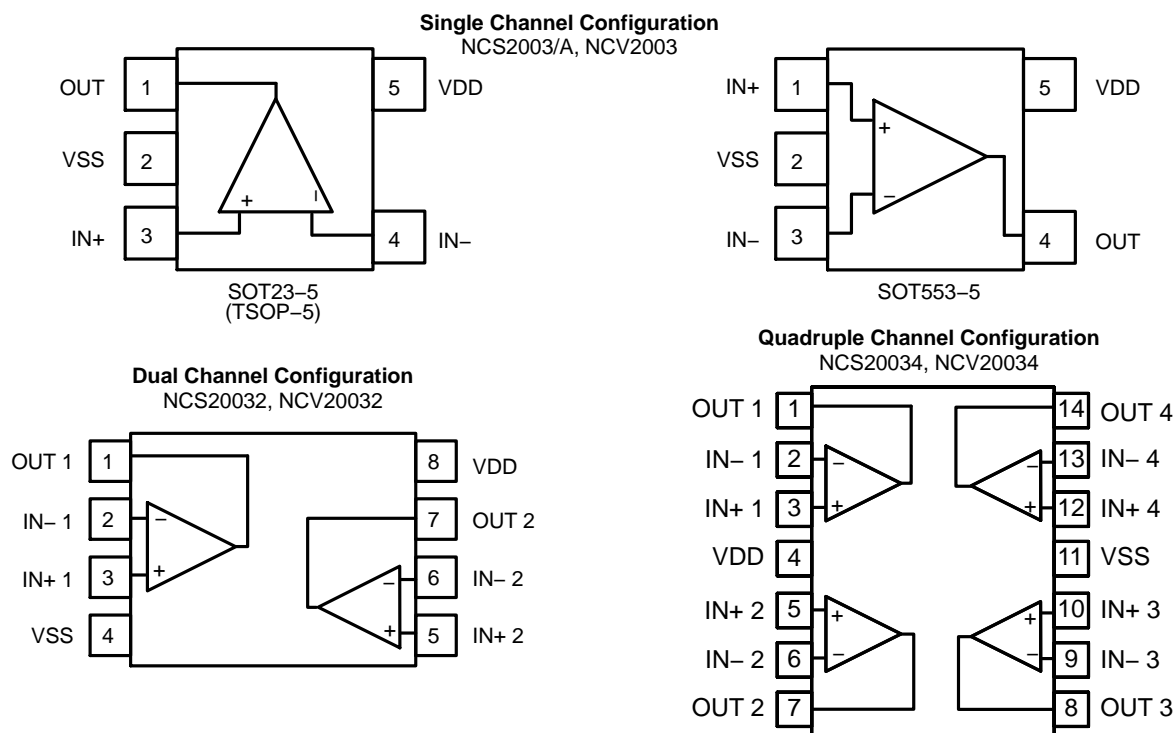

Figure 1. Pin Connections

## ORDERING INFORMATION

Device	Configuration	Automotive	Marking	Package	Shipping†
NCS2003SN2T1G	Single	No	AN3	SOT23-5 (Pb-Free)	3000 / Tape and Reel
NCS2003ASN2T1G		No	AN4	SOT23-5 (Pb-Free)	3000 / Tape and Reel
NCS2003XV53T2G		No	A3	SOT553-5 (Pb-Free)	4000 / Tape and Reel
NCV2003SN2T1G*		Yes	AN3	SOT23-5 (Pb-Free)	3000 / Tape and Reel
NCS20032DMR2G	Dual	No	2K32	Micro8 (Pb-Free)	4000 / Tape and Reel
NCS20032DR2G			20032	SOIC-8 (Pb-Free)	2500 / Tape and Reel
NCS20032DTBR2G			K32	TSSOP-8 (Pb-Free)	3000 / Tape and Reel
NCV20032DMR2G*		Yes	2K32	Micro8 (Pb-Free)	4000 / Tape and Reel
NCV20032DR2G*			20032	SOIC-8 (Pb-Free)	2500 / Tape and Reel
NCV20032DTBR2G*			K32	TSSOP-8 (Pb-Free)	3000 / Tape and Reel
NCS20034DR2G	Quad	No	NCS20034G	SOIC-14 (Pb-Free)	2500 / Tape and Reel
NCV20034DR2G*		Yes	NCS20034G	SOIC-14 (Pb-Free)	2500 / Tape and Reel

†For information on tape and reel specifications, including part orientation and tape sizes, please refer to our Tape and Reel Packaging Specifications Brochure, BRD8011/D

\*NCV Prefix for Automotive and Other Applications Requiring Unique Site and Control Change Requirements; AEC-Q100 Qualified and PPAP Capable.

# NCS2003/A, NCV2003, NCS20032, NCV20032, NCS20034, NCV20034

## ABSOLUTE MAXIMUM RATINGS

Over operating free-air temperature, unless otherwise stated

Parameter	Symbol	Limit	Unit
Supply Voltage ( $V_{DD} - V_{SS}$ )	$V_S$	7.0	V

## INPUT AND OUTPUT PINS

Input Voltage (Note 1)	$V_{IN}$	$V_{SS} - 0.3$ to 7.0	V
Input Current	$I_{IN}$	10	mA
Output Short Current (Note 2)	$I_O$	100	mA

## TEMPERATURE

Storage Temperature	$T_{STG}$	-65 to 150	°C
Junction Temperature	$T_J$	150	°C

## ESD RATINGS (Note 3)

Human Body Model	NCx2003, A NCx20032 NCx20034	HBM	3000 2000 3000	V
Machine Model	NCx2003, A NCx20032 NCx20034	MM	200 100 150	V
Charged Device Model	NCx2003, A NCx2003x	CDM	1000 2000	V

## OTHER PARAMETERS

Moisture Sensitivity Level (Note 5)	MSL	Level 1	
Latch-up Current (Note 4)	$I_{LU}$	100	mA

Stresses exceeding those listed in the Maximum Ratings table may damage the device. If any of these limits are exceeded, device functionality should not be assumed, damage may occur and reliability may be affected.

- Neither input should exceed the range of  $V_{SS} - 300$  mV to 7.0 V. This device contains internal protection diodes between the input pins and  $V_{DD}$ . When  $V_{IN}$  exceeds  $V_{DD}$ , the input current should be limited to the specified value.
- Indefinite duration; however, maximum package power dissipation limits must be observed to ensure that the maximum junction temperature is not exceeded.
- This device series incorporates ESD protection and is tested by the following methods:  
ESD Human Body Model tested per AEC-Q100-002 and JESD22-A114  
ESD Machine Model tested per AEC-Q100-003 and JESD22-A115  
ESD Charged Device Model tested per AEC-Q100-011 and ANSI/ESD S5.3.1-2009
- Latch-up current tested per JEDEC Standard JESD78.
- Moisture Sensitivity Level tested per IPC/JEDEC standard J-STD-020A.

## THERMAL INFORMATION

Thermal Metric	Symbol	Package	Single Layer Board (Note 6)	Multi Layer Board (Note 7)	Unit
Junction to Ambient Thermal Resistance	$\theta_{JA}$	SOT23-5/TSOP-5	408	355	°C/W
		SOT553-5	428	406	
		Micro8/MSOP8	235	163	
		SOIC-8	240	179	
		TSSOP-8	300	238	
		SOIC-14	167	123	

6. Values based on a 1S standard PCB according to JEDEC51-3 with 1.0 oz copper and a 300 mm<sup>2</sup> copper area

7. Values based on a 1S2P standard PCB according to JEDEC51-7 with 1.0 oz copper and a 100 mm<sup>2</sup> copper area

## RECOMMENDED OPERATING CONDITIONS

Parameter	Symbol	Min	Max	Unit
Operating Supply Voltage ( $V_{DD} - V_{SS}$ )	$V_S$	1.7	5.5	V
Specified Operating Range	NCS2003, A NCV2003, NCx20032, NCx20034 $T_A$	-40 -40	+85 +125	°C
Input Common Mode Range	$V_{CM}$	$V_{SS}$	$V_{DD}-0.6$	V

Functional operation above the stresses listed in the Recommended Operating Ranges is not implied. Extended exposure to stresses beyond the Recommended Operating Ranges limits may affect device reliability.

# NCS2003/A, NCV2003, NCS20032, NCV20032, NCS20034, NCV20034

## ELECTRICAL CHARACTERISTICS: $V_S = +1.8\text{ V}$

At  $T_A = +25^\circ\text{C}$ ,  $R_L = 10\text{ k}\Omega$  connected to midsupply,  $V_{CM} = V_{OUT} = \text{midsupply}$ , unless otherwise noted. **Boldface** limits apply over the specified temperature range. Guaranteed by design and/or characterization.

Parameter	Symbol	Conditions	Min	Typ	Max	Unit
<b>INPUT CHARACTERISTICS</b>						
Input Offset Voltage	$V_{OS}$	NCS2003A		0.5	3.0	mV
		NCx2003, NCx20032, NCx20034		0.5	4.0	mV
Offset Voltage Drift	$\Delta V_{OS}/\Delta T$			<b>2.0</b>		$\mu\text{V}/^\circ\text{C}$
		NCS2003A (Note 8)			6.0	$\mu\text{V}/^\circ\text{C}$
Input Bias Current	$I_{IB}$			1		pA
Input Offset Current	$I_{OS}$			1		pA
Channel Separation	XTLK	DC, NCx20032, NCx20034		100		dB
Input Resistance	$R_{IN}$			1		$\text{T}\Omega$
Input Capacitance	$C_{IN}$			1.2		pF
Common Mode Rejection Ratio	CMRR	$V_{IN} = V_{SS}$ to $V_{DD} - 0.6\text{ V}$	70	80		dB
		$V_{IN} = V_{SS} + 0.2\text{ V}$ to $V_{DD} - 0.6\text{ V}$	<b>65</b>			

## OUTPUT CHARACTERISTICS

Open Loop Voltage Gain	$A_{VOL}$	$R_L = 10\text{ k}\Omega$		80	92	dB	
				<b>75</b>			
		$R_L = 2\text{ k}\Omega$			92		
				<b>70</b>			
Output Current Capability (Note 8)	$I_{SC}$	Sourcing		5	8	mA	
		Sinking		10	14		
Output Voltage High	$V_{OH}$	$R_L = 10\text{ k}\Omega$		<b>1.75</b>	1.798	V	
		$R_L = 2\text{ k}\Omega$		<b>1.7</b>	1.78		
Output Voltage Low	$V_{OL}$	$R_L = 10\text{ k}\Omega$	NCx2003, A		7	<b>50</b>	mV
			NCx2003x		7	<b>100</b>	
		$R_L = 2\text{ k}\Omega$				20	

## NOISE PERFORMANCE

Voltage Noise Density	$e_N$	$f = 1\text{ kHz}$		20		$\text{nV}/\sqrt{\text{Hz}}$
Current Noise Density	$i_N$	$f = 1\text{ kHz}$		0.1		$\text{pA}/\sqrt{\text{Hz}}$

## DYNAMIC PERFORMANCE

Gain Bandwidth Product	GBWP			5		MHz
Slew Rate at Unity Gain	SR	Rising Edge, $R_L = 2\text{ k}\Omega$ , $A_V = +1$		6		$\text{V}/\mu\text{s}$
		Falling Edge, $R_L = 2\text{ k}\Omega$ , $A_V = +1$		9		
Phase Margin	$\psi_m$	$R_L = 10\text{ k}\Omega$ , $C_L = 5\text{ pF}$		53		$^\circ$
Gain Margin	$A_m$	$R_L = 10\text{ k}\Omega$ , $C_L = 5\text{ pF}$	NCx2003, A	12		dB
			NCx2003x	8		
Settling Time	$t_s$	$V_O = 1\text{ V}_{pp}$ , Gain = 1, $C_L = 20\text{ pF}$	Settling time to 0.1%	1.8		$\mu\text{s}$

Product parametric performance is indicated in the Electrical Characteristics for the listed test conditions, unless otherwise noted. Product performance may not be indicated by the Electrical Characteristics if operated under different conditions.

8. Guaranteed by design and/or characterization.

# NCS2003/A, NCV2003, NCS20032, NCV20032, NCS20034, NCV20034

## ELECTRICAL CHARACTERISTICS: $V_S = +1.8\text{ V}$

At  $T_A = +25^\circ\text{C}$ ,  $R_L = 10\text{ k}\Omega$  connected to midsupply,  $V_{CM} = V_{OUT} = \text{midsupply}$ , unless otherwise noted. **Boldface** limits apply over the specified temperature range. Guaranteed by design and/or characterization.

Parameter	Symbol	Conditions	Min	Typ	Max	Unit
-----------	--------	------------	-----	-----	-----	------

### DYNAMIC PERFORMANCE

Total Harmonics Distortion + Noise	THD+N	$V_O = 1\text{ V}_{pp}$ , $R_L = 2\text{ k}\Omega$ , $A_V = +1$ , $f = 1\text{ kHz}$		0.005		%
		$V_O = 1\text{ V}_{pp}$ , $R_L = 2\text{ k}\Omega$ , $A_V = +1$ , $f = 10\text{ kHz}$		0.025		

### POWER SUPPLY

Power Supply Rejection Ratio	PSRR	NCx2003		72	80		dB
				<b>65</b>			
		NCx20032, NCx20034		<b>80</b>	100		
Quiescent Current	$I_{DD}$	No load, per channel	NCx2003, A		230	560	$\mu\text{A}$
						<b>1000</b>	
			NCx20032, NCx20034		275	375	
						<b>575</b>	

Product parametric performance is indicated in the Electrical Characteristics for the listed test conditions, unless otherwise noted. Product performance may not be indicated by the Electrical Characteristics if operated under different conditions.

8. Guaranteed by design and/or characterization.

## ELECTRICAL CHARACTERISTICS: $V_S = +5.0\text{ V}$

At  $T_A = +25^\circ\text{C}$ ,  $R_L = 10\text{ k}\Omega$  connected to midsupply,  $V_{CM} = V_{OUT} = \text{midsupply}$ , unless otherwise noted. **Boldface** limits apply over the specified temperature range. Guaranteed by design and/or characterization.

Parameter	Symbol	Conditions	Min	Typ	Max	Unit
-----------	--------	------------	-----	-----	-----	------

### INPUT CHARACTERISTICS

Input Offset Voltage	$V_{OS}$	NCS2003A		0.5	3.0	mV
		NCx2003		0.5	4.0	mV
		NCx20032, NCx20034			<b>5.0</b>	mV
Offset Voltage Drift	$\Delta V_{OS}/\Delta T$			<b>2.0</b>		$\mu\text{V}/^\circ\text{C}$
		NCS2003A (Note 9)			6.0	$\mu\text{V}/^\circ\text{C}$
Input Bias Current	$I_{IB}$			1		pA
Input Offset Current	$I_{OS}$			1		pA
Channel Separation	XTLK	DC, NCx20032, NCx20034		100		dB
Input Resistance	$R_{IN}$			1		$\text{T}\Omega$
Input Capacitance	$C_{IN}$			1.2		pF

Product parametric performance is indicated in the Electrical Characteristics for the listed test conditions, unless otherwise noted. Product performance may not be indicated by the Electrical Characteristics if operated under different conditions.

9. Guaranteed by design and/or characterization.

# NCS2003/A, NCV2003, NCS20032, NCV20032, NCS20034, NCV20034

## ELECTRICAL CHARACTERISTICS: $V_S = +5.0\text{ V}$

At  $T_A = +25^\circ\text{C}$ ,  $R_L = 10\text{ k}\Omega$  connected to midsupply,  $V_{CM} = V_{OUT} = \text{midsupply}$ , unless otherwise noted. **Boldface** limits apply over the specified temperature range. Guaranteed by design and/or characterization.

Parameter	Symbol	Conditions	Min	Typ	Max	Unit
-----------	--------	------------	-----	-----	-----	------

### INPUT CHARACTERISTICS

Common Mode Rejection Ratio	CMRR	NCx2003, A	V <sub>IN</sub> = V <sub>SS</sub> to V <sub>DD</sub> - 0.6 V	65	90	dB
			V <sub>IN</sub> = V <sub>SS</sub> + 0.2 V to V <sub>DD</sub> - 0.6 V	<b>63</b>		
		NCx20032, NCx20034	V <sub>IN</sub> = V <sub>SS</sub> to V <sub>DD</sub> - 0.6 V	70	90	
			V <sub>IN</sub> = V <sub>SS</sub> + 0.2 V to V <sub>DD</sub> - 0.6 V	<b>65</b>		

### OUTPUT CHARACTERISTICS

Open Loop Voltage Gain	A <sub>VOL</sub>	R <sub>L</sub> = 10 k $\Omega$		86	92	dB
				<b>78</b>		
		R <sub>L</sub> = 2 k $\Omega$		83	92	
				<b>78</b>		
Output Current Capability (Note 9)	I <sub>SC</sub>	Sourcing		40	76	mA
		Sinking		50	96	
Output Voltage High	V <sub>OH</sub>	R <sub>L</sub> = 10 k $\Omega$		<b>4.95</b>	4.99	V
		R <sub>L</sub> = 2 k $\Omega$		<b>4.9</b>	4.97	
Output Voltage Low	V <sub>OL</sub>	R <sub>L</sub> = 10 k $\Omega$	NCx2003, A	8	<b>50</b>	mV
			NCx2003x	8	<b>100</b>	
		R <sub>L</sub> = 2 k $\Omega$			24	

### NOISE PERFORMANCE

Voltage Noise Density	e <sub>N</sub>	f = 1 kHz	20		nV/ $\sqrt{\text{Hz}}$
Current Noise Density	i <sub>N</sub>	f = 1 kHz	0.1		pA/ $\sqrt{\text{Hz}}$

### DYNAMIC PERFORMANCE

Gain Bandwidth Product	GBWP			7		MHz
Slew Rate at Unity Gain	SR	Rising Edge, R <sub>L</sub> = 2 k $\Omega$ , A <sub>V</sub> = +1		8		V/ $\mu\text{s}$
		Falling Edge, R <sub>L</sub> = 2 k $\Omega$ , A <sub>V</sub> = +1		12.5		
Phase Margin	$\psi_m$	R <sub>L</sub> = 10 k $\Omega$ , C <sub>L</sub> = 5 pF	NCx2003, A	64		°
			NCx2003x	56		
Gain Margin	A <sub>m</sub>	R <sub>L</sub> = 10 k $\Omega$ , C <sub>L</sub> = 5 pF		9		dB
Settling Time	t <sub>S</sub>	V <sub>O</sub> = 1 V <sub>pp</sub> , Gain = 1, C <sub>L</sub> = 20 pF	Settling time to 0.1%	0.6		$\mu\text{s}$
Total Harmonics Distortion + Noise	THD+N	V <sub>O</sub> = 4 V <sub>pp</sub> , R <sub>L</sub> = 2 k $\Omega$ , A <sub>V</sub> = +1, f = 1 kHz		0.002		%
		V <sub>O</sub> = 4 V <sub>pp</sub> , R <sub>L</sub> = 2 k $\Omega$ , A <sub>V</sub> = +1, f = 10 kHz		0.01		

Product parametric performance is indicated in the Electrical Characteristics for the listed test conditions, unless otherwise noted. Product performance may not be indicated by the Electrical Characteristics if operated under different conditions.

9. Guaranteed by design and/or characterization.

# NCS2003/A, NCV2003, NCS20032, NCV20032, NCS20034, NCV20034

## ELECTRICAL CHARACTERISTICS: $V_S = +5.0\text{ V}$

At  $T_A = +25^\circ\text{C}$ ,  $R_L = 10\text{ k}\Omega$  connected to midsupply,  $V_{CM} = V_{OUT} = \text{midsupply}$ , unless otherwise noted. **Boldface** limits apply over the specified temperature range. Guaranteed by design and/or characterization.

Parameter	Symbol	Conditions	Min	Typ	Max	Unit	
<b>POWER SUPPLY</b>							
Power Supply Rejection Ratio	PSRR	NCx2003, A		72	80		dB
				<b>65</b>			
		NCx20032, NCx20034		<b>80</b>	100		
Quiescent Current	$I_{DD}$	No load, per channel	NCx2003, A		300	660	$\mu\text{A}$
				<b>1000</b>			
			NCx20032, NCx20034		325	450	
				<b>675</b>			

Product parametric performance is indicated in the Electrical Characteristics for the listed test conditions, unless otherwise noted. Product performance may not be indicated by the Electrical Characteristics if operated under different conditions.

9. Guaranteed by design and/or characterization.

TYPICAL CHARACTERISTICS

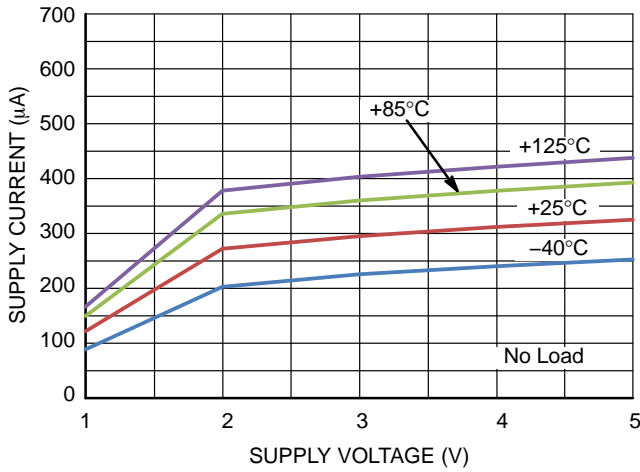

Figure 2. Quiescent Supply Current vs. Supply Voltage

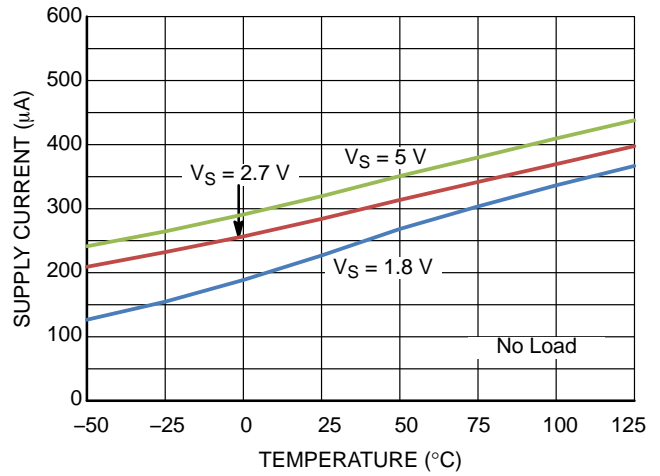

Figure 3. Quiescent Supply Current vs. Temperature

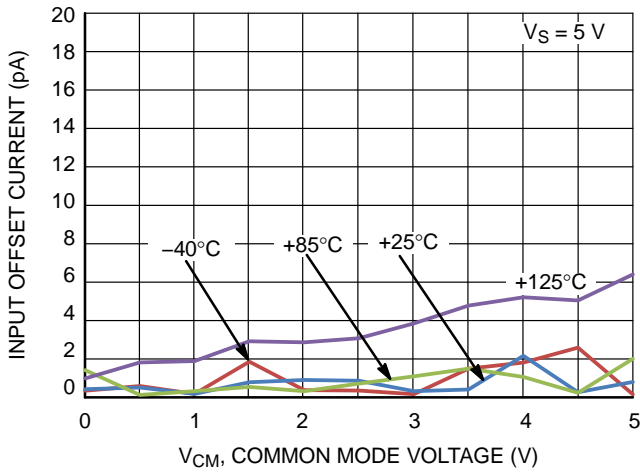

Figure 4. Input Offset Current vs.  $V_{CM}$

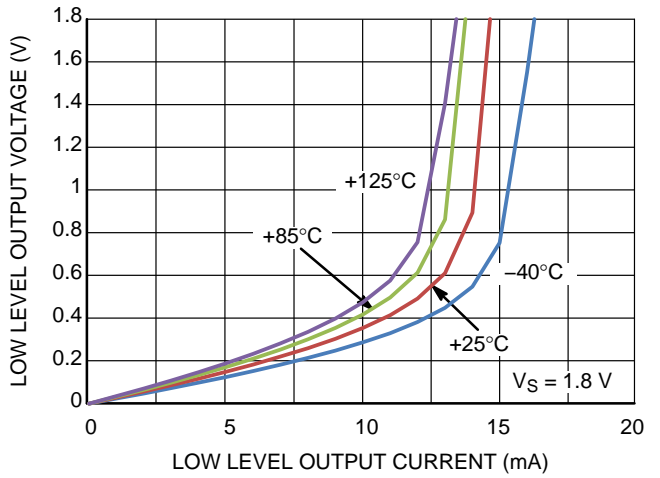

Figure 5. Low Level Output Voltage vs. Output Current @  $V_S = 1.8 V$

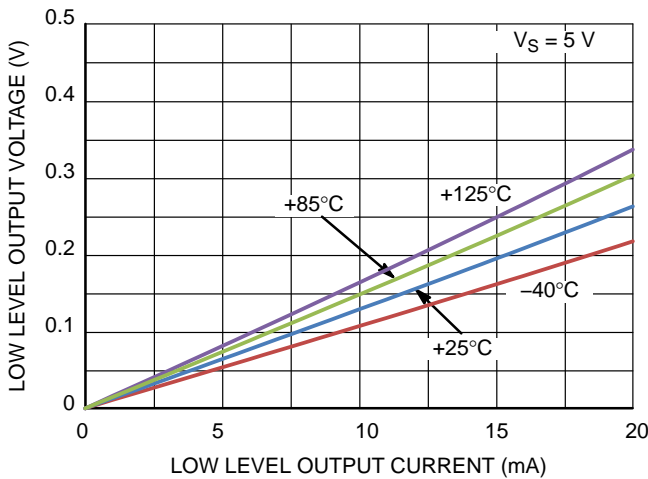

Figure 6. Low Level Output Voltage vs. Output Current @  $V_S = 5 V$

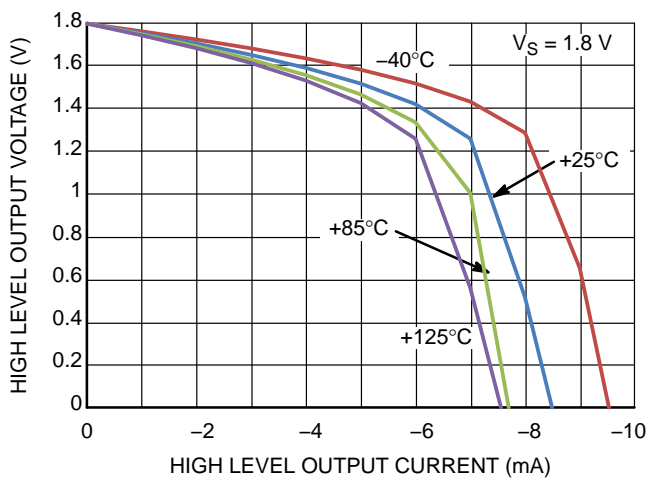

Figure 7. High Level Output Voltage vs. Output Current @  $V_S = 1.8 V$

TYPICAL CHARACTERISTICS

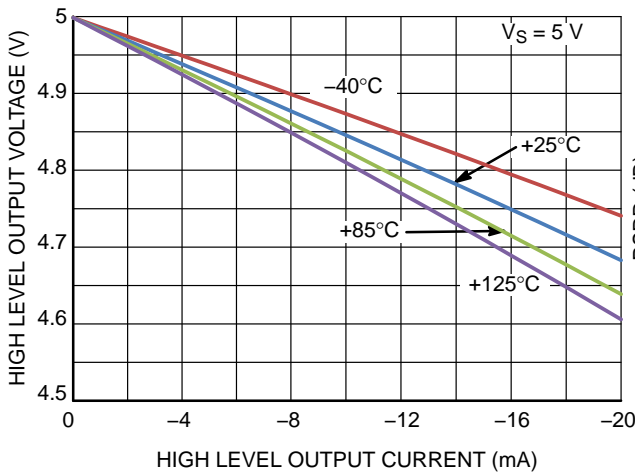

Figure 8. High Level Output Voltage vs. Output Current @  $V_S = 5\text{ V}$

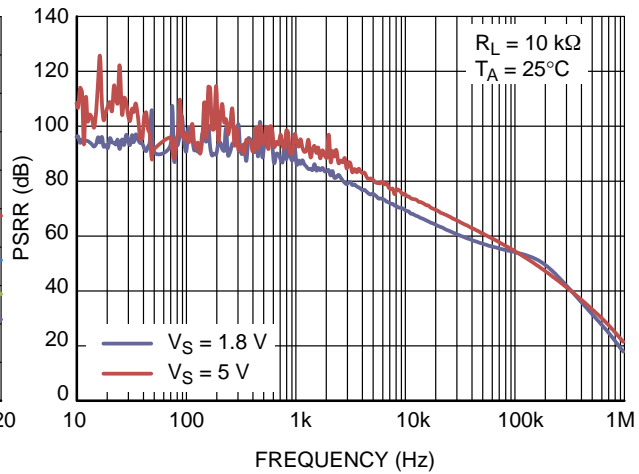

Figure 9. PSRR vs. Frequency

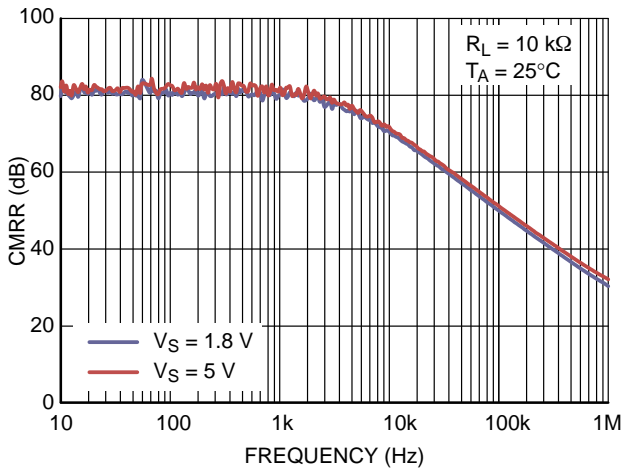

Figure 10. CMRR vs. Frequency

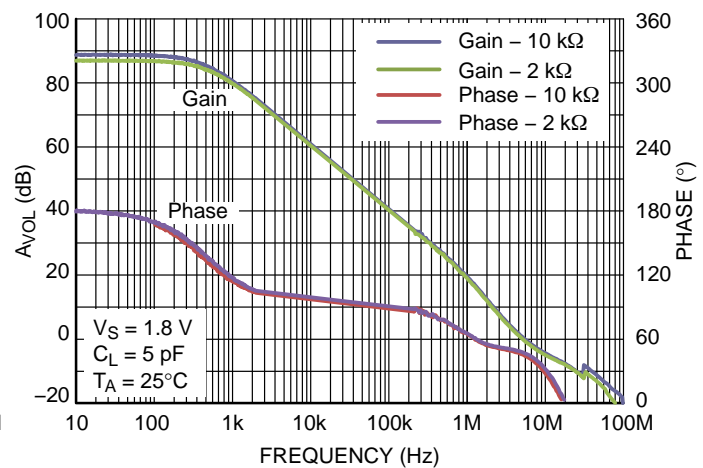

Figure 11. Open Loop Gain and Phase vs. Frequency @  $V_S = 1.8\text{ V}$

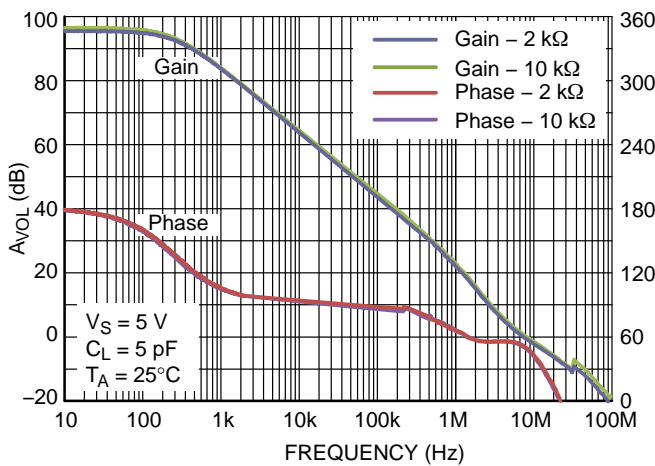

Figure 12. Open Loop Gain and Phase vs. Frequency @  $V_S = 5\text{ V}$

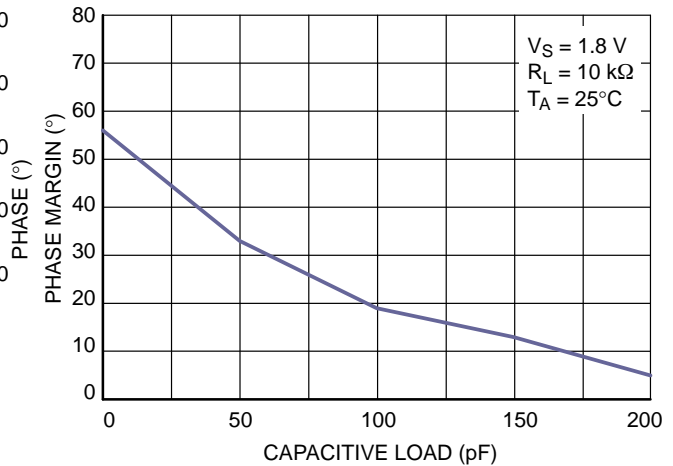

Figure 13. Phase Margin vs. Capacitive Load

TYPICAL CHARACTERISTICS

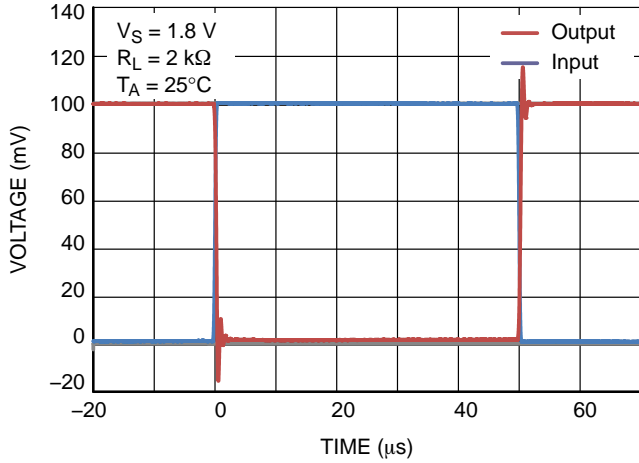

Figure 14. Inverting Small Signal Transient Response

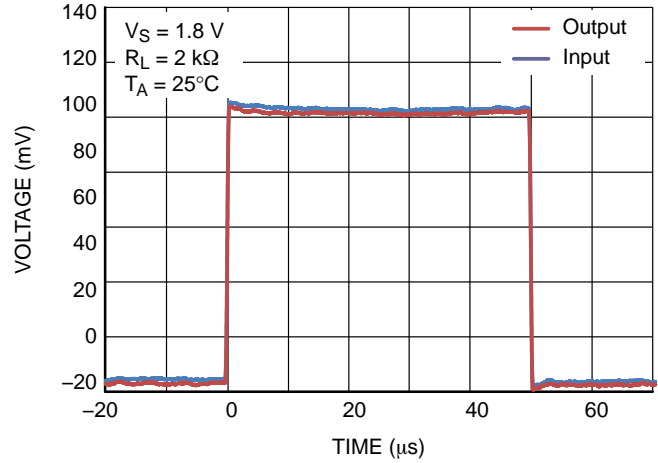

Figure 15. Non-Inverting Small Signal Transient Response

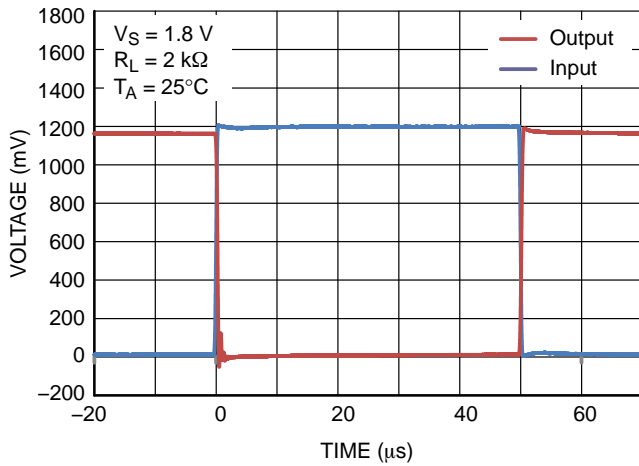

Figure 16. Inverting Large Signal Transient Response

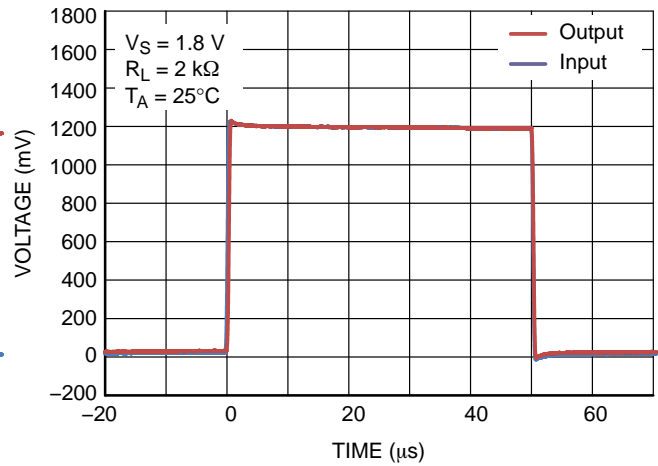

Figure 17. Non-Inverting Large Signal Transient Response

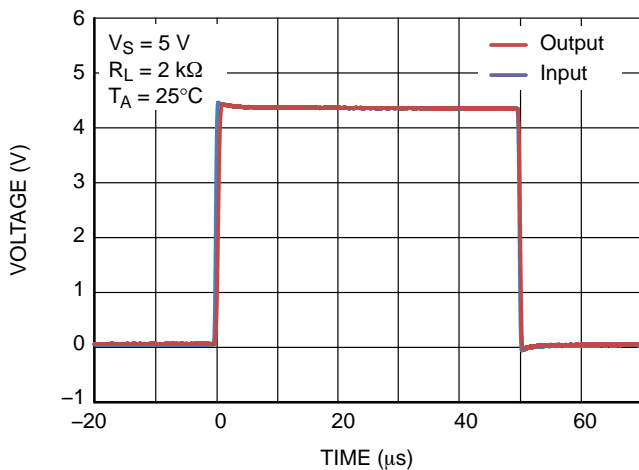

Figure 18. Non-Inverting Large Signal Transient Response

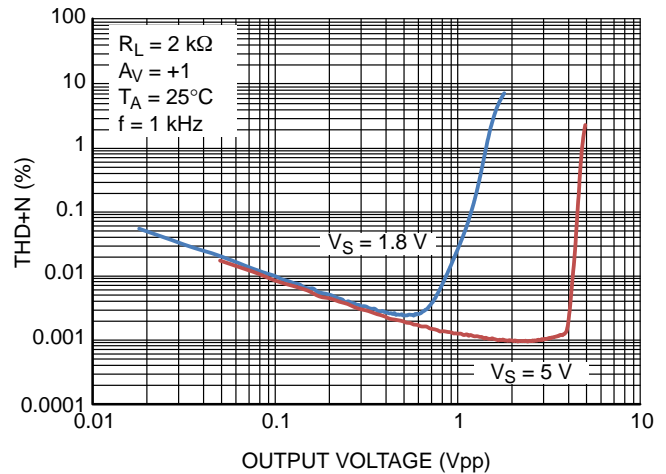

Figure 19. THD+N vs. Output Voltage

TYPICAL CHARACTERISTICS

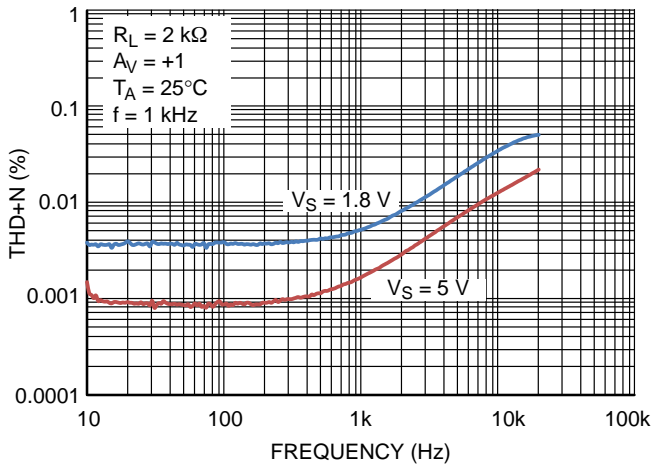

Figure 20. THD+N vs. Frequency

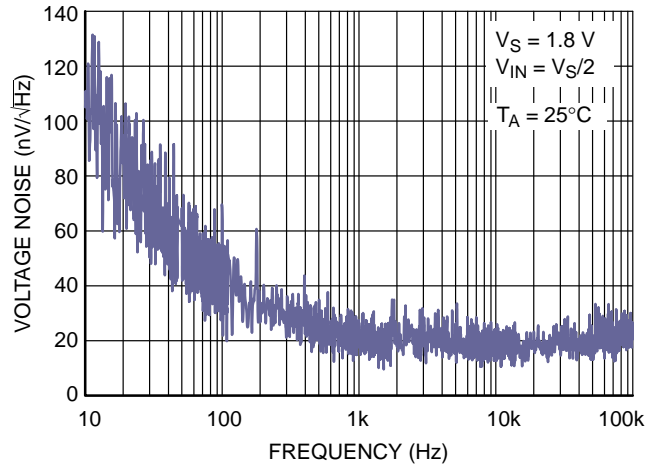

Figure 21. Input Voltage Noise vs. Frequency

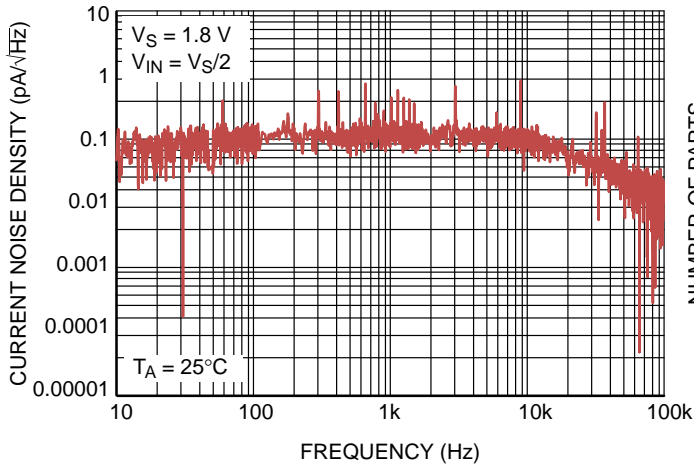

Figure 22. Noise Density vs. Frequency

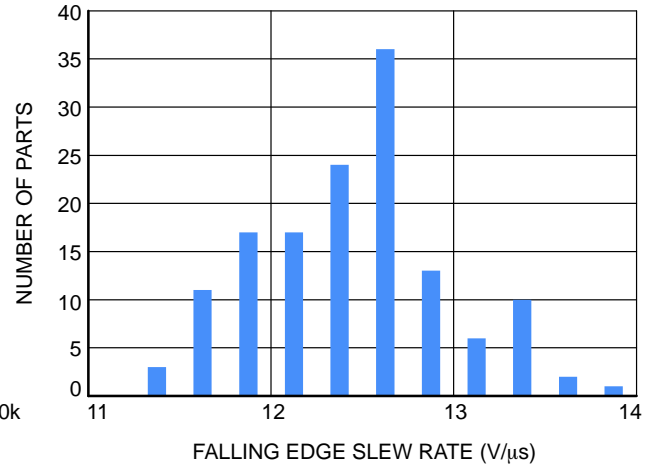

Figure 23. Falling Edge Slew Rate @ Vs = 5 V

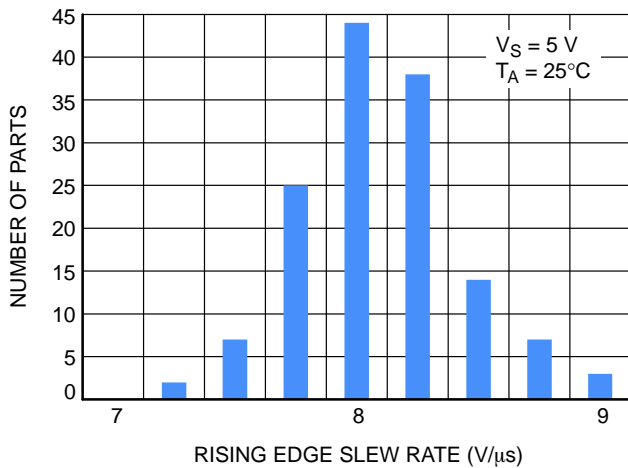

Figure 24. Rising Edge Slew Rate @ Vs = 5 V

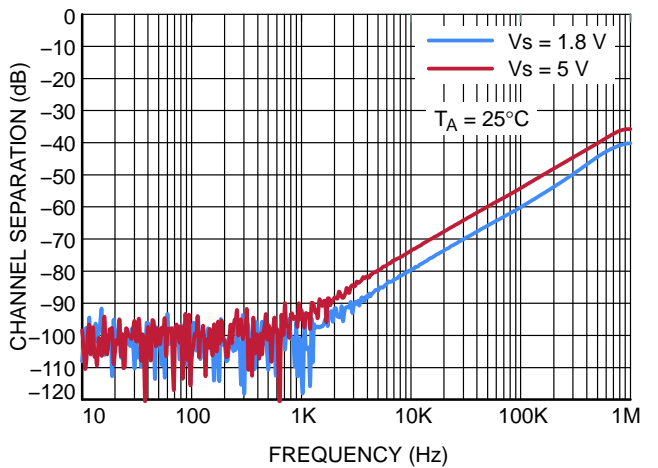
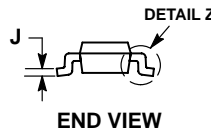
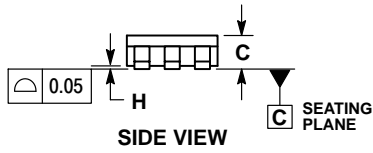
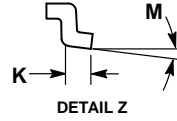
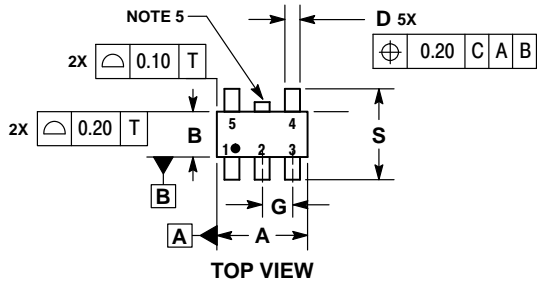

Figure 25. Channel Separation

PACKAGE DIMENSIONS

TSOP-5  
CASE 483-02  
ISSUE K



NOTES:

1. DIMENSIONING AND TOLERANCING PER ASME Y14.5M, 1994.
2. CONTROLLING DIMENSION: MILLIMETERS.
3. MAXIMUM LEAD THICKNESS INCLUDES LEAD FINISH THICKNESS. MINIMUM LEAD THICKNESS IS THE MINIMUM THICKNESS OF BASE MATERIAL.
4. DIMENSIONS A AND B DO NOT INCLUDE MOLD FLASH, PROTRUSIONS, OR GATE BURRS. MOLD FLASH, PROTRUSIONS, OR GATE BURRS SHALL NOT EXCEED 0.15 PER SIDE. DIMENSION A.
5. OPTIONAL CONSTRUCTION: AN ADDITIONAL TRIMMED LEAD IS ALLOWED IN THIS LOCATION. TRIMMED LEAD NOT TO EXTEND MORE THAN 0.2 FROM BODY.

MILLIMETERS		
DIM	MIN	MAX
A	3.00	BSC
B	1.50	BSC
C	0.90	1.10
D	0.25	0.50
G	0.95	BSC
H	0.01	0.10
J	0.10	0.26
K	0.20	0.60
M	0°	10°
S	2.50	3.00

SOLDERING FOOTPRINT\*

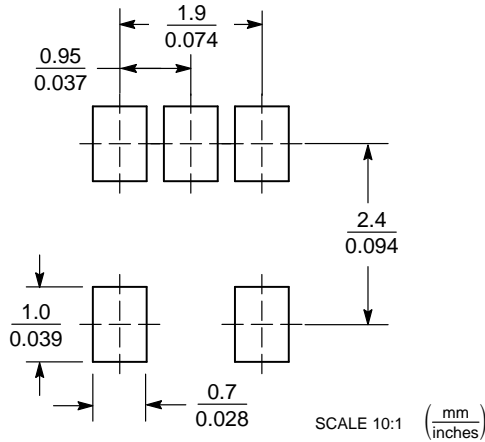

\*For additional information on our Pb-Free strategy and soldering details, please download the ON Semiconductor Soldering and Mounting Techniques Reference Manual, SOLDERRM/D.

PACKAGE DIMENSIONS

SOT-553, 5 LEAD  
CASE 463B  
ISSUE C

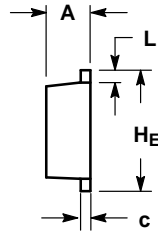
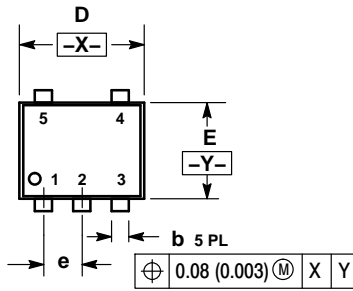

NOTES:

1. DIMENSIONING AND TOLERANCING PER ANSI Y14.5M, 1982.
2. CONTROLLING DIMENSION: MILLIMETERS
3. MAXIMUM LEAD THICKNESS INCLUDES LEAD FINISH THICKNESS. MINIMUM LEAD THICKNESS IS THE MINIMUM THICKNESS OF BASE MATERIAL.

DIM	MILLIMETERS			INCHES		
	MIN	NOM	MAX	MIN	NOM	MAX
A	0.50	0.55	0.60	0.020	0.022	0.024
b	0.17	0.22	0.27	0.007	0.009	0.011
c	0.08	0.13	0.18	0.003	0.005	0.007
D	1.55	1.60	1.65	0.061	0.063	0.065
E	1.15	1.20	1.25	0.045	0.047	0.049
e	0.50 BSC			0.020 BSC		
L	0.10	0.20	0.30	0.004	0.008	0.012
HE	1.55	1.60	1.65	0.061	0.063	0.065

RECOMMENDED  
SOLDERING FOOTPRINT\*

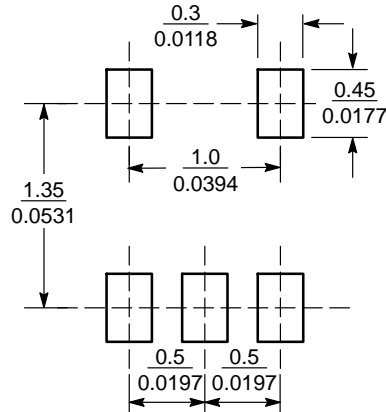

SCALE 20:1 (mm/inches)

\*For additional information on our Pb-Free strategy and soldering details, please download the ON Semiconductor Soldering and Mounting Techniques Reference Manual, SOLDERRM/D.

PACKAGE DIMENSIONS

Micro8™  
CASE 846A-02  
ISSUE J

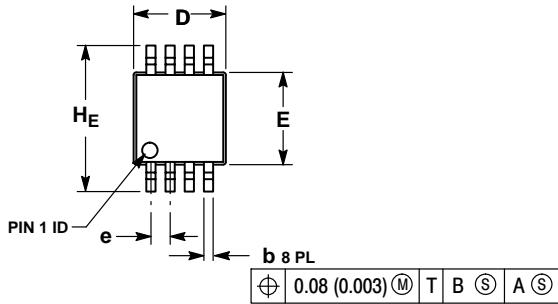

NOTES:

1. DIMENSIONING AND TOLERANCING PER ANSI Y14.5M, 1982.
2. CONTROLLING DIMENSION: MILLIMETER.
3. DIMENSION A DOES NOT INCLUDE MOLD FLASH, PROTRUSIONS OR GATE BURRS. MOLD FLASH, PROTRUSIONS OR GATE BURRS SHALL NOT EXCEED 0.15 (0.006) PER SIDE.
4. DIMENSION B DOES NOT INCLUDE INTERLEAD FLASH OR PROTRUSION. INTERLEAD FLASH OR PROTRUSION SHALL NOT EXCEED 0.25 (0.010) PER SIDE.
5. 846A-01 OBSOLETE, NEW STANDARD 846A-02.

DIM	MILLIMETERS			INCHES		
	MIN	NOM	MAX	MIN	NOM	MAX
A	—	—	1.10	—	—	0.043
A1	0.05	0.08	0.15	0.002	0.003	0.006
b	0.25	0.33	0.40	0.010	0.013	0.016
c	0.13	0.18	0.23	0.005	0.007	0.009
D	2.90	3.00	3.10	0.114	0.118	0.122
E	2.90	3.00	3.10	0.114	0.118	0.122
e	0.65 BSC			0.026 BSC		
L	0.40	0.55	0.70	0.016	0.021	0.028
HE	4.75	4.90	5.05	0.187	0.193	0.199

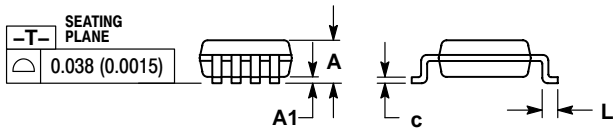

RECOMMENDED  
SOLDERING FOOTPRINT\*

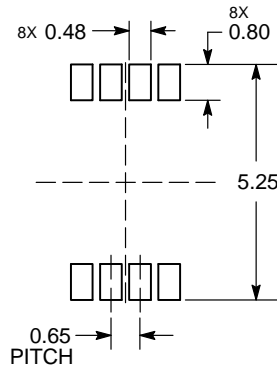

DIMENSION: MILLIMETERS

\*For additional information on our Pb-Free strategy and soldering details, please download the ON Semiconductor Soldering and Mounting Techniques Reference Manual, SOLDERRM/D.

PACKAGE DIMENSIONS

SOIC-8 NB  
CASE 751-07  
ISSUE AK

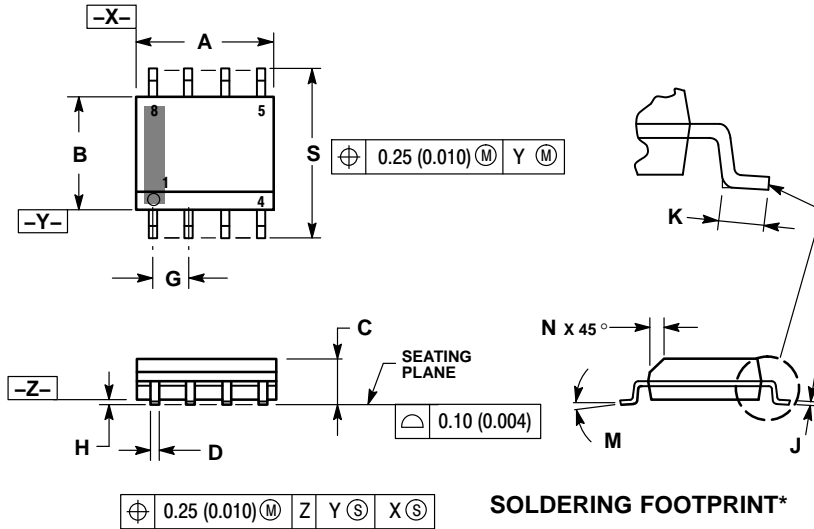

NOTES:

1. DIMENSIONING AND TOLERANCING PER ANSI Y14.5M, 1982.
2. CONTROLLING DIMENSION: MILLIMETER.
3. DIMENSION A AND B DO NOT INCLUDE MOLD PROTRUSION.
4. MAXIMUM MOLD PROTRUSION 0.15 (0.006) PER SIDE.
5. DIMENSION D DOES NOT INCLUDE DAMBAR PROTRUSION. ALLOWABLE DAMBAR PROTRUSION SHALL BE 0.127 (0.005) TOTAL IN EXCESS OF THE D DIMENSION AT MAXIMUM MATERIAL CONDITION.
6. 751-01 THRU 751-06 ARE OBSOLETE. NEW STANDARD IS 751-07.

DIM	MILLIMETERS		INCHES	
	MIN	MAX	MIN	MAX
A	4.80	5.00	0.189	0.197
B	3.80	4.00	0.150	0.157
C	1.35	1.75	0.053	0.069
D	0.33	0.51	0.013	0.020
G	1.27 BSC		0.050 BSC	
H	0.10	0.25	0.004	0.010
J	0.19	0.25	0.007	0.010
K	0.40	1.27	0.016	0.050
M	0° - 8°		0° - 8°	
N	0.25	0.50	0.010	0.020
S	5.80	6.20	0.228	0.244

SOLDERING FOOTPRINT\*

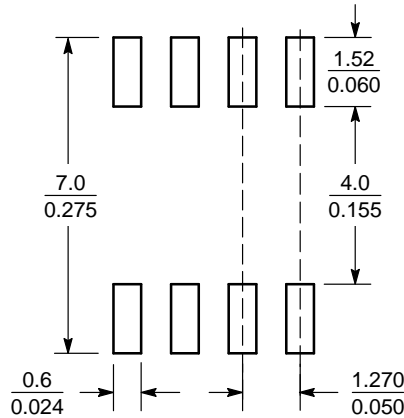

SCALE 6:1 ( $\frac{\text{mm}}{\text{inches}}$ )

\*For additional information on our Pb-Free strategy and soldering details, please download the ON Semiconductor Soldering and Mounting Techniques Reference Manual, SOLDERRM/D.

PACKAGE DIMENSIONS

TSSOP-8  
CASE 948S  
ISSUE C

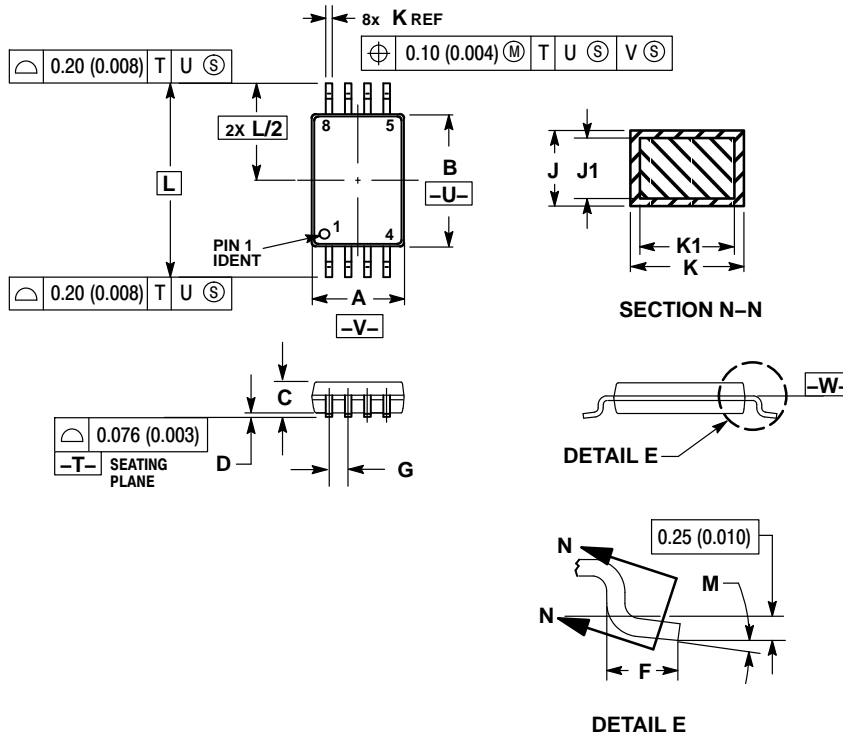

- NOTES:
1. DIMENSIONING AND TOLERANCING PER ANSI Y14.5M, 1982.
  2. CONTROLLING DIMENSION: MILLIMETER.
  3. DIMENSION A DOES NOT INCLUDE MOLD FLASH. PROTRUSIONS OR GATE BURRS. MOLD FLASH OR GATE BURRS SHALL NOT EXCEED 0.15 (0.006) PER SIDE.
  4. DIMENSION B DOES NOT INCLUDE INTERLEAD FLASH OR PROTRUSION. INTERLEAD FLASH OR PROTRUSION SHALL NOT EXCEED 0.25 (0.010) PER SIDE.
  5. TERMINAL NUMBERS ARE SHOWN FOR REFERENCE ONLY.
  6. DIMENSION A AND B ARE TO BE DETERMINED AT DATUM PLANE -W-.

DIM	MILLIMETERS		INCHES	
	MIN	MAX	MIN	MAX
A	2.90	3.10	0.114	0.122
B	4.30	4.50	0.169	0.177
C	---	1.10	---	0.043
D	0.05	0.15	0.002	0.006
F	0.50	0.70	0.020	0.028
G	0.65 BSC		0.026 BSC	
J	0.09	0.20	0.004	0.008
J1	0.09	0.16	0.004	0.006
K	0.19	0.30	0.007	0.012
K1	0.19	0.25	0.007	0.010
L	6.40 BSC		0.252 BSC	
M	0°	8°	0°	8°

PACKAGE DIMENSIONS

SOIC-14 NB  
CASE 751A-03  
ISSUE K

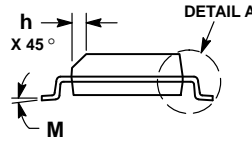
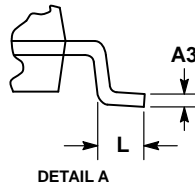
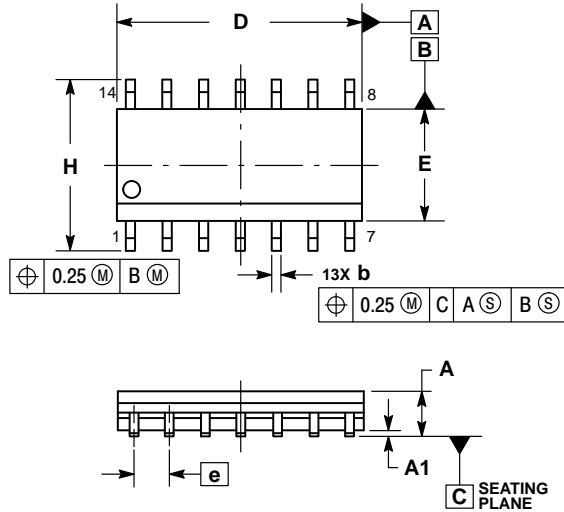

NOTES:

1. DIMENSIONING AND TOLERANCING PER ASME Y14.5M, 1994.
2. CONTROLLING DIMENSION: MILLIMETERS.
3. DIMENSION b DOES NOT INCLUDE DAMBAR PROTRUSION. ALLOWABLE PROTRUSION SHALL BE 0.13 TOTAL IN EXCESS OF AT MAXIMUM MATERIAL CONDITION.
4. DIMENSIONS D AND E DO NOT INCLUDE MOLD PROTRUSIONS.
5. MAXIMUM MOLD PROTRUSION 0.15 PER SIDE.

DIM	MILLIMETERS		INCHES	
	MIN	MAX	MIN	MAX
A	1.35	1.75	0.054	0.068
A1	0.10	0.25	0.004	0.010
A3	0.19	0.25	0.008	0.010
b	0.35	0.49	0.014	0.019
D	8.55	8.75	0.337	0.344
E	3.80	4.00	0.150	0.157
e	1.27 BSC		0.050 BSC	
H	5.80	6.20	0.228	0.244
h	0.25	0.50	0.010	0.019
L	0.40	1.25	0.016	0.049
M	0°	7°	0°	7°

SOLDERING FOOTPRINT\*

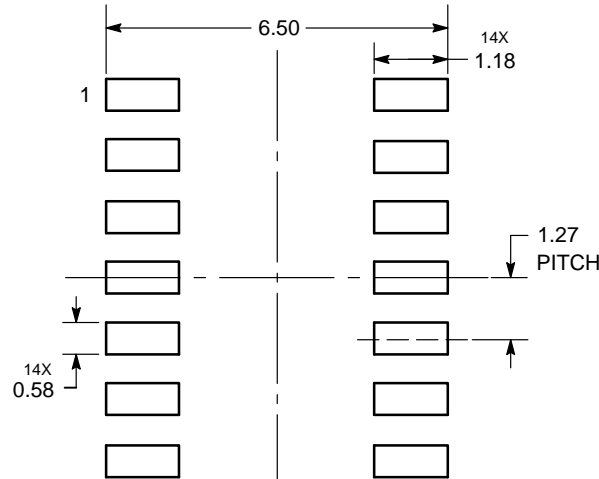

DIMENSIONS: MILLIMETERS

\*For additional information on our Pb-Free strategy and soldering details, please download the ON Semiconductor Soldering and Mounting Techniques Reference Manual, SOLDERRM/D.

Micro8 is a trademark of International Rectifier.

ON Semiconductor and are trademarks of Semiconductor Components Industries, LLC dba ON Semiconductor or its subsidiaries in the United States and/or other countries. ON Semiconductor owns the rights to a number of patents, trademarks, copyrights, trade secrets, and other intellectual property. A listing of ON Semiconductor's product/patent coverage may be accessed at [www.onsemi.com/site/pdf/Patent-Marking.pdf](http://www.onsemi.com/site/pdf/Patent-Marking.pdf). ON Semiconductor reserves the right to make changes without further notice to any products herein. ON Semiconductor makes no warranty, representation or guarantee regarding the suitability of its products for any particular purpose, nor does ON Semiconductor assume any liability arising out of the application or use of any product or circuit, and specifically disclaims any and all liability, including without limitation special, consequential or incidental damages. Buyer is responsible for its products and applications using ON Semiconductor products, including compliance with all laws, regulations and safety requirements or standards, regardless of any support or applications information provided by ON Semiconductor. "Typical" parameters which may be provided in ON Semiconductor data sheets and/or specifications can and do vary in different applications and actual performance may vary over time. All operating parameters, including "Typicals" must be validated for each customer application by customer's technical experts. ON Semiconductor does not convey any license under its patent rights nor the rights of others. ON Semiconductor products are not designed, intended, or authorized for use as a critical component in life support systems or any FDA Class 3 medical devices or medical devices with a same or similar classification in a foreign jurisdiction or any devices intended for implantation in the human body. Should Buyer purchase or use ON Semiconductor products for any such unintended or unauthorized application, Buyer shall indemnify and hold ON Semiconductor and its officers, employees, subsidiaries, affiliates, and distributors harmless against all claims, costs, damages, and expenses, and reasonable attorney fees arising out of, directly or indirectly, any claim of personal injury or death associated with such unintended or unauthorized use, even if such claim alleges that ON Semiconductor was negligent regarding the design or manufacture of the part. ON Semiconductor is an Equal Opportunity/Affirmative Action Employer. This literature is subject to all applicable copyright laws and is not for resale in any manner.

PUBLICATION ORDERING INFORMATION

**LITERATURE FULFILLMENT:**  
Literature Distribution Center for ON Semiconductor  
19521 E. 32nd Pkwy, Aurora, Colorado 80011 USA  
**Phone:** 303-675-2175 or 800-344-3860 Toll Free USA/Canada  
**Fax:** 303-675-2176 or 800-344-3867 Toll Free USA/Canada  
**Email:** [orderlit@onsemi.com](mailto:orderlit@onsemi.com)

**N. American Technical Support:** 800-282-9855 Toll Free USA/Canada  
**Europe, Middle East and Africa Technical Support:**  
Phone: 421 33 790 2910  
**Japan Customer Focus Center**  
Phone: 81-3-5817-1050

**ON Semiconductor Website:** [www.onsemi.com](http://www.onsemi.com)  
**Order Literature:** <http://www.onsemi.com/orderlit>

For additional information, please contact your local Sales Representative

## Looking for pricing, stock, or lifecycle information?

Click below to explore more details on WIN SOURCE:

 [View NCS2003SN2T1G on WIN SOURCE](#)

 [ON Semiconductor](#) Information

## Optimize Your Supply Chain with WIN SOURCE Solutions

-  Global Sourcing Solution
-  Obsolete Management
-  Cost Control Management
-  Shortage Management
-  Alternative Solution
-  Excess Inventory Management