

NCP5304

High Voltage, High and Low Side Driver

The NCP5304 is a High Voltage Power gate Driver providing two outputs for direct drive of 2 N-channel power MOSFETs or IGBTs arranged in a half-bridge configuration.

It uses the bootstrap technique to insure a proper drive of the High-side power switch. The driver works with 2 independent inputs with cross conduction protection.

Features

- High Voltage Range: up to 600 V
- dV/dt Immunity ± 50 V/nsec
- Negative Current Injection Characterized Over the Temperature Range
- Gate Drive Supply Range from 10 V to 20 V
- High and Low Drive Outputs
- Output Source / Sink Current Capability 250 mA / 500 mA
- 3.3 V and 5 V Input Logic Compatible
- Up to V_{CC} Swing on Input Pins
- Extended Allowable Negative Bridge Pin Voltage Swing to -10 V for Signal Propagation
- Matched Propagation Delays between Both Channels
- Outputs in Phase with the Inputs
- Cross Conduction Protection with 100 ns Internal Fixed Dead Time
- Under V_{CC} LockOut (UVLO) for Both Channels
- Pin-to-Pin Compatible with Industry Standards
- These are Pb-Free Devices

Typical Applications

- Half-bridge Power Converters
- Full-bridge Converters



ON Semiconductor®

www.onsemi.com

MARKING DIAGRAMS

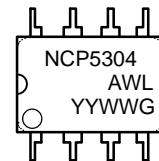
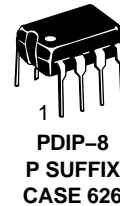
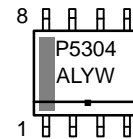

NCP5304 = Specific Device Code
A = Assembly Location
L or WL = Wafer Lot
Y or YY = Year
W or WW = Work Week
G or ■ = Pb-Free Package

PINOUT INFORMATION

IN_LO	1	8	VBOOT
IN_HI	2	7	DRV_HI
VCC	3	6	BRIDGE
GND	4	5	DRV_LO

8 Pin Package

ORDERING INFORMATION

Device	Package	Shipping†
NCP5304PG	PDIP-8 (Pb-Free)	50 Units / Rail
NCP5304DR2G	SOIC-8 (Pb-Free)	2500 / Tape & Reel

†For information on tape and reel specifications, including part orientation and tape sizes, please refer to our Tape and Reel Packaging Specification Brochure, BRD8011/D.

NCP5304

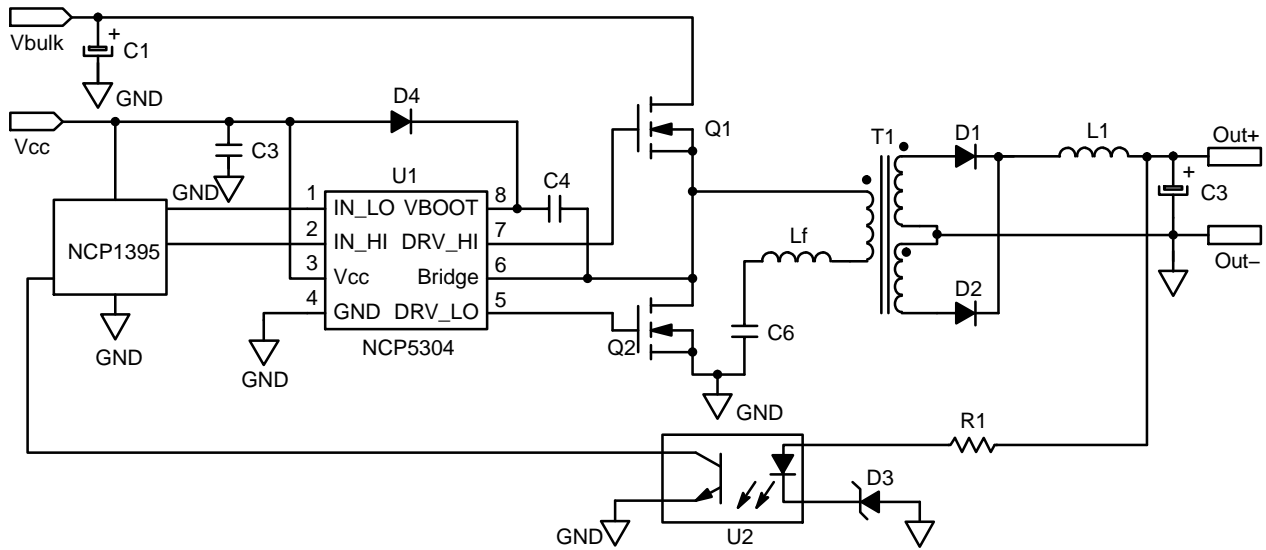

Figure 1. Typical Application Resonant Converter (LLC type)

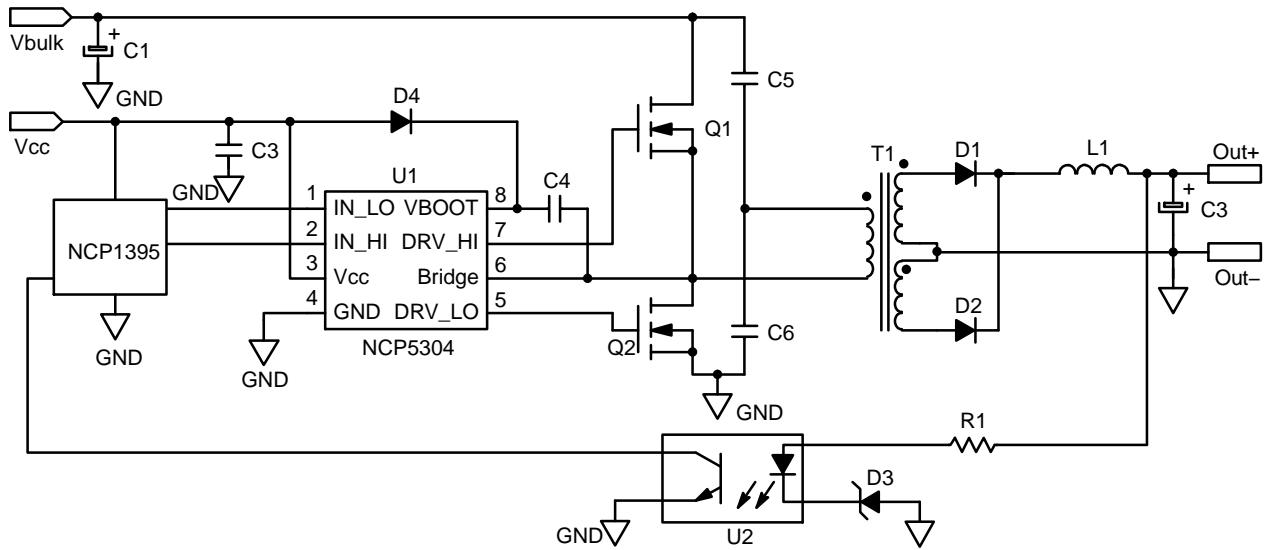

Figure 2. Typical Application Half Bridge Converter

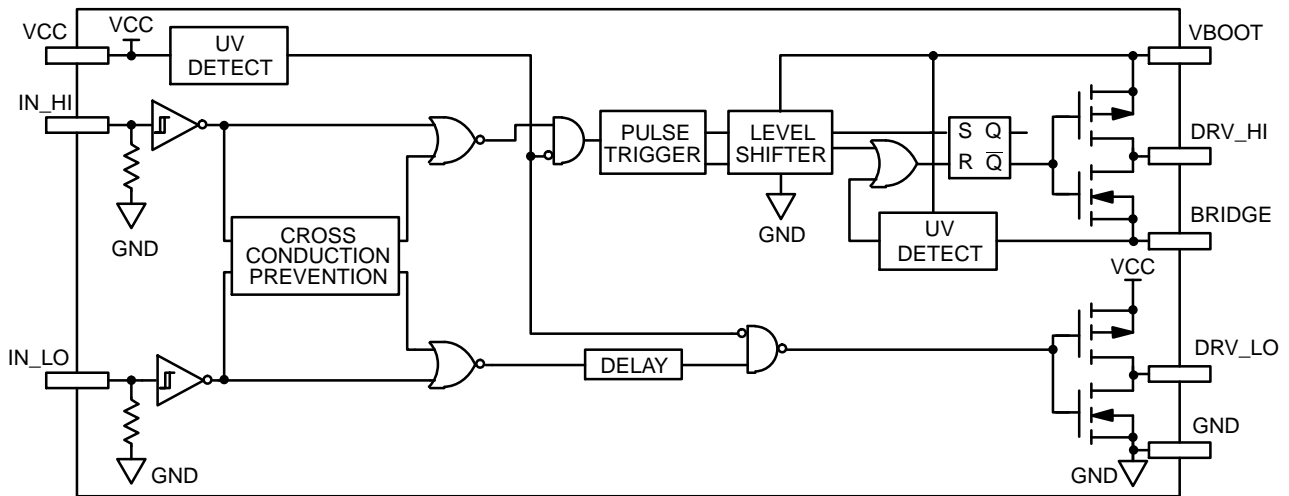

Figure 3. Detailed Block Diagram

NCP5304

PIN DESCRIPTIONS

Pin No.	Pin Name	Pin Function
1	IN_LO	Logic Input for Low side driver output in phase
2	IN_HI	Logic Input for High side driver output in phase
3	VCC	Low side and main power supply
4	GND	Ground
5	DRV_LO	Low side gate drive output
6	BRIDGE	Bootstrap return or High side floating supply return
7	DRV_HI	High side gate drive output
8	VBOOT	Bootstrap power supply

MAXIMUM RATINGS

Rating	Symbol	Value	Unit
V_{CC}	Main power supply voltage	-0.3 to 20	V
$V_{CC_transient}$	Main transient power supply voltage: $I_{V_{CC_max}} = 5 \text{ mA}$ during 10 ms	23	V
V_{BRIDGE}	VHV: High Voltage BRIDGE pin	-1 to 600	V
V_{BRIDGE}	Allowable Negative Bridge Pin Voltage for IN_LO Signal Propagation to DRV_LO (see characterization curves for detailed results)	-10	V
$V_{BOOT-V_{BRIDGE}}$	VHV: Floating supply voltage	-0.3 to 20	V
V_{DRV_HI}	VHV: High side output voltage	$V_{BRIDGE} - 0.3$ to $V_{BOOT} + 0.3$	V
V_{DRV_LO}	Low side output voltage	-0.3 to $V_{CC} + 0.3$	V
dV_{BRIDGE}/dt	Allowable output slew rate	50	V/ns
V_{IN_XX}	Inputs IN_HI, IN_LO	-1.0 to $V_{CC} + 0.3$	V
	ESD Capability:		
	- HBM model (all pins except pins 6-7-8 in 8 pins package or 11-12-13 in 14 pins package)	2	kV
	- Machine model (all pins except pins 6-7-8 in 8 pins package or 11-12-13 in 14 pins package)	200	V
	Latch up capability per Jedec JESD78		
$R_{\theta JA}$	Power dissipation and Thermal characteristics PDIP-8: Thermal Resistance, Junction-to-Air SO-8: Thermal Resistance, Junction-to-Air	100 178	°C/W
T_{J_max}	Maximum Operating Junction Temperature	+150	°C

Stresses exceeding those listed in the Maximum Ratings table may damage the device. If any of these limits are exceeded, device functionality should not be assumed, damage may occur and reliability may be affected.

NCP5304

ELECTRICAL CHARACTERISTIC ($V_{CC} = V_{boot} = 15\text{ V}$, $V_{GND} = V_{bridge}$, $-40^{\circ}\text{C} < T_J < 125^{\circ}\text{C}$, Outputs loaded with 1 nF)

Rating	Symbol	$T_J -40^{\circ}\text{C to } 125^{\circ}\text{C}$			Units
		Min	Typ	Max	

OUTPUT SECTION

Output high short circuit pulsed current $V_{DRV} = 0\text{ V}$, $PW \leq 10\ \mu\text{s}$ (Note 1)	$I_{DRVsource}$	–	250	–	mA
Output low short circuit pulsed current $V_{DRV} = V_{CC}$, $PW \leq 10\ \mu\text{s}$ (Note 1)	$I_{DRVsink}$	–	500	–	mA
Output resistor (Typical value @ 25°C) Source	R_{OH}	–	30	60	Ω
Output resistor (Typical value @ 25°C) Sink	R_{OL}	–	10	20	Ω
High level output voltage, $V_{BIAS} - V_{DRV_XX}$ @ $I_{DRV_XX} = 20\text{ mA}$	V_{DRV_H}	–	0.7	1.6	V
Low level output voltage V_{DRV_XX} @ $I_{DRV_XX} = 20\text{ mA}$	V_{DRV_L}	–	0.2	0.6	V

DYNAMIC OUTPUT SECTION

Turn-on propagation delay ($V_{bridge} = 0\text{ V}$)	t_{ON}	–	100	170	ns
Turn-off propagation delay ($V_{bridge} = 0\text{ V}$ or 50 V) (Note 2)	t_{OFF}	–	100	170	ns
Output voltage rise time (from 10% to 90% @ $V_{CC} = 15\text{ V}$) with 1 nF load	t_r	–	85	160	ns
Output voltage fall time (from 90% to 10% @ $V_{CC} = 15\text{ V}$) with 1 nF load	t_f	–	35	75	ns
Propagation delay matching between the High side and the Low side @ 25°C (Note 3)	Δt	–	20	35	ns
Internal fixed dead time (Note 4)	DT	65	100	190	ns
Minimum input width that changes the output	t_{PW1}	–	–	50	ns
Maximum input width that does not change the output	t_{PW2}	20	–	–	ns

INPUT SECTION

Low level input voltage threshold	V_{IN}	–	–	0.8	V
Input pull-down resistor ($V_{IN} < 0.5\text{ V}$)	R_{IN}	–	200	–	k Ω
High level input voltage threshold	V_{IN}	2.3	–	–	V
Logic “1” input bias current @ $V_{IN_XX} = 5\text{ V}$ @ 25°C	I_{IN+}	–	5	25	μA
Logic “0” input bias current @ $V_{IN_XX} = 0\text{ V}$ @ 25°C	I_{IN-}	–	–	2.0	μA

SUPPLY SECTION

V_{CC} UV Start-up voltage threshold	V_{CC_stup}	8.0	8.9	9.9	V
V_{CC} UV Shut-down voltage threshold	V_{CC_shtdwn}	7.3	8.2	9.1	V
Hysteresis on V_{CC}	V_{CC_hyst}	0.3	0.7	–	V
Vboot Start-up voltage threshold reference to bridge pin ($V_{boot_stup} = V_{boot} - V_{bridge}$)	V_{boot_stup}	8.0	8.9	9.9	V
Vboot UV Shut-down voltage threshold	V_{boot_shtdwn}	7.3	8.2	9.1	V
Hysteresis on Vboot	V_{boot_shtdwn}	0.3	0.7	–	V
Leakage current on high voltage pins to GND ($V_{BOOT} = V_{BRIDGE} = DRV_HI = 600\text{ V}$)	I_{HV_LEAK}	–	5	40	μA
Consumption in active mode ($V_{CC} = V_{boot}$, $f_{sw} = 100\text{ kHz}$ and 1 nF load on both driver outputs)	$ICC1$	–	4	5	mA
Consumption in inhibition mode ($V_{CC} = V_{boot}$)	$ICC2$	–	250	400	μA
V_{CC} current consumption in inhibition mode	$ICC3$	–	200	–	μA
Vboot current consumption in inhibition mode	$ICC4$	–	50	–	μA

1. Parameter guaranteed by design
2. Turn-off propagation delay @ $V_{bridge} = 600\text{ V}$ is guaranteed by design
3. See characterization curve for Δt parameters variation on the full range temperature.
4. Timing diagram definition see Figure 7.
5. Timing diagram definition see Figure 5 and Figure 6.

Product parametric performance is indicated in the Electrical Characteristics for the listed test conditions, unless otherwise noted. Product performance may not be indicated by the Electrical Characteristics if operated under different conditions.

NCP5304

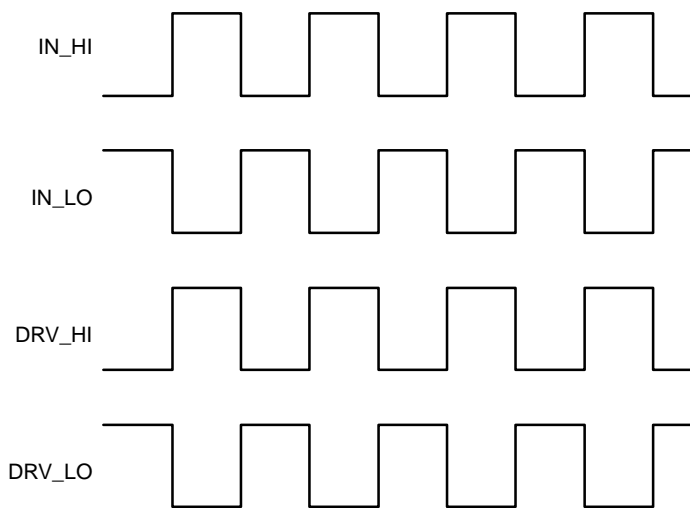

Figure 4. Input/Output Timing Diagram

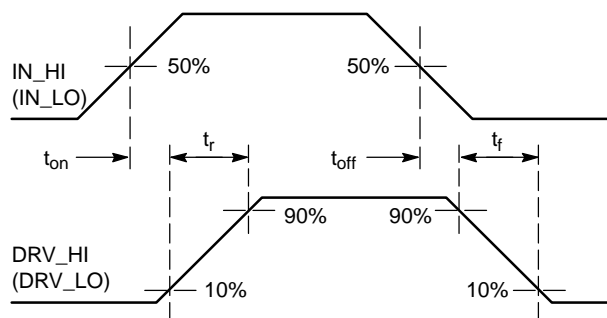

Figure 5. Propagation Delay and Rise / Fall Time Definition

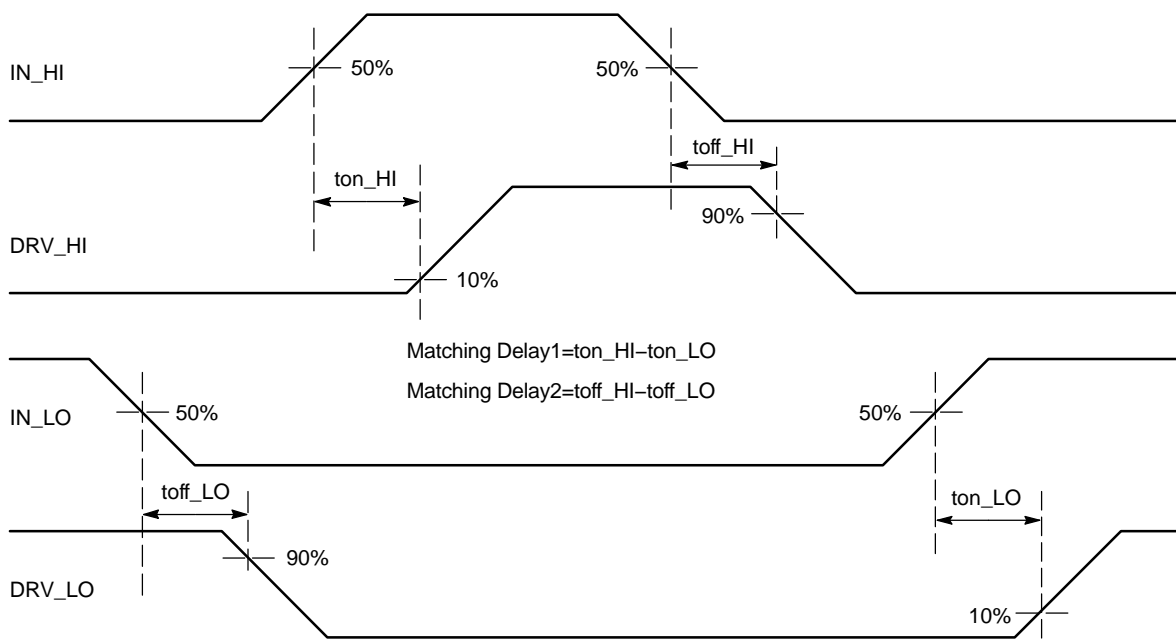

Figure 6. Matching Propagation Delay

NCP5304

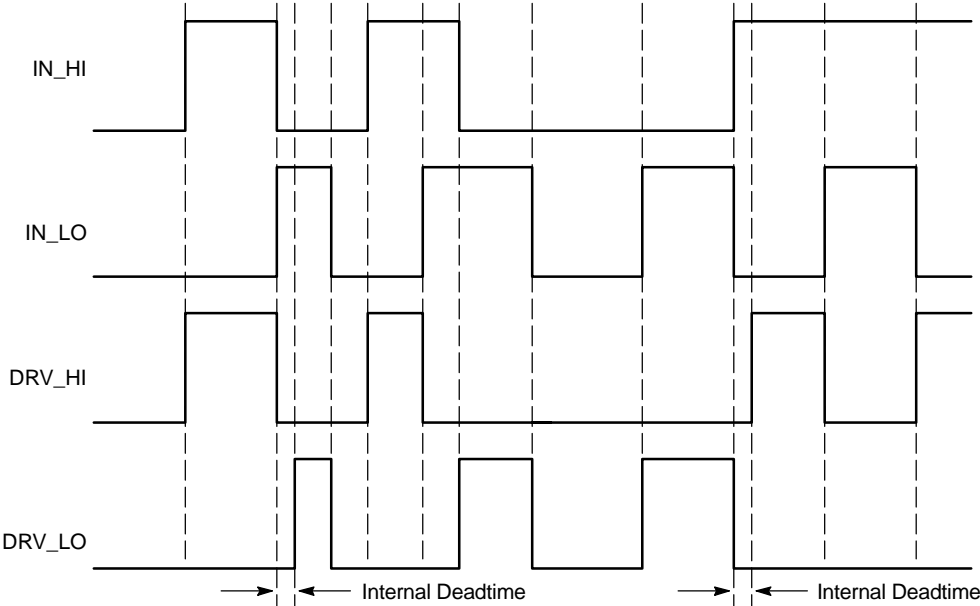

Figure 7. Input/Output Cross Conduction Output Protection Timing Diagram

CHARACTERIZATION CURVES

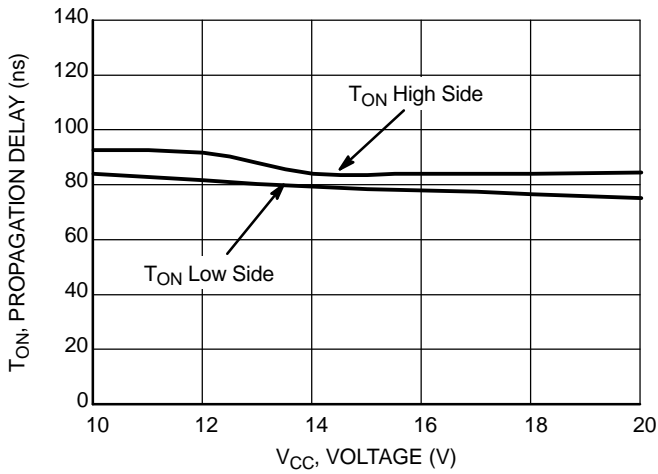

Figure 8. Turn ON Propagation Delay vs. Supply Voltage ($V_{CC} = V_{BOOT}$)

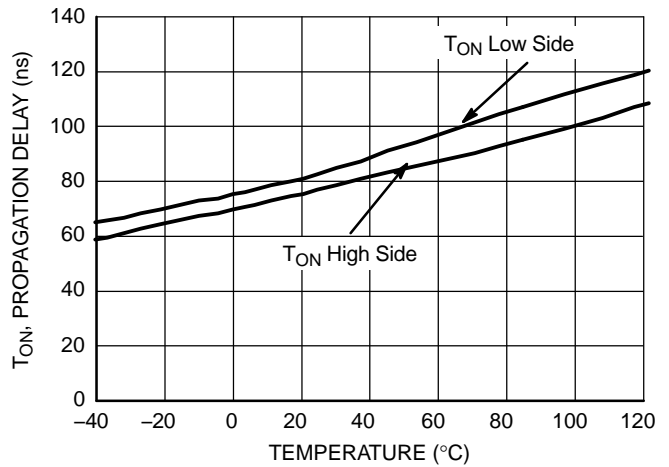

Figure 9. Turn ON Propagation Delay vs. Temperature

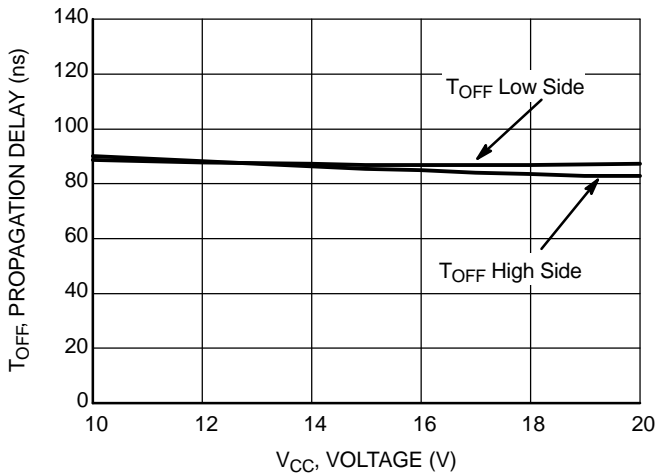

Figure 10. Turn OFF Propagation Delay vs. Supply Voltage ($V_{CC} = V_{BOOT}$)

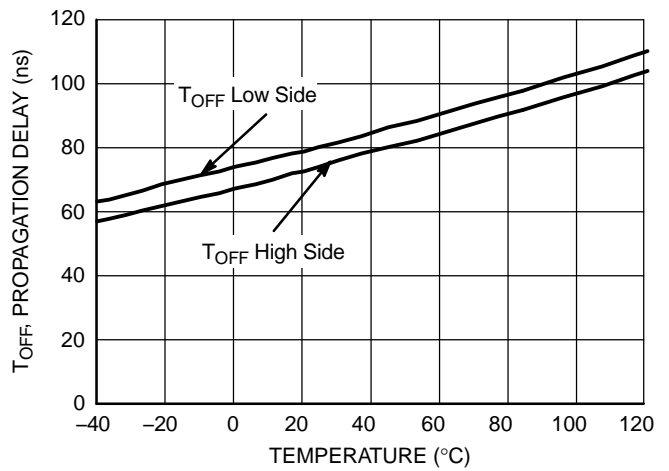

Figure 11. Turn OFF Propagation Delay vs. Temperature

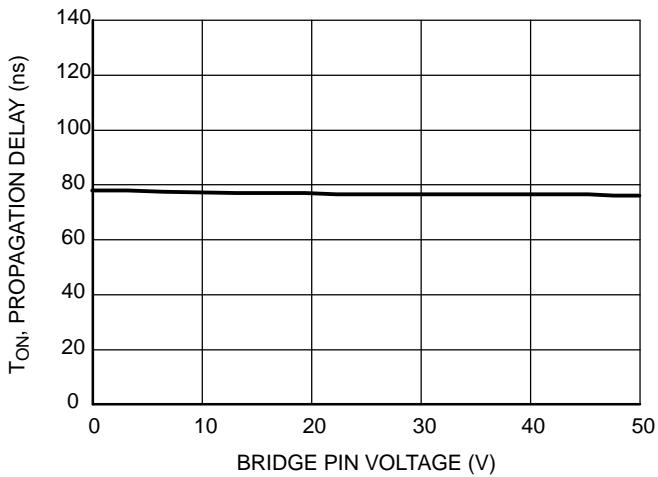

Figure 12. High Side Turn ON Propagation Delay vs. V_{BRIDGE} Voltage

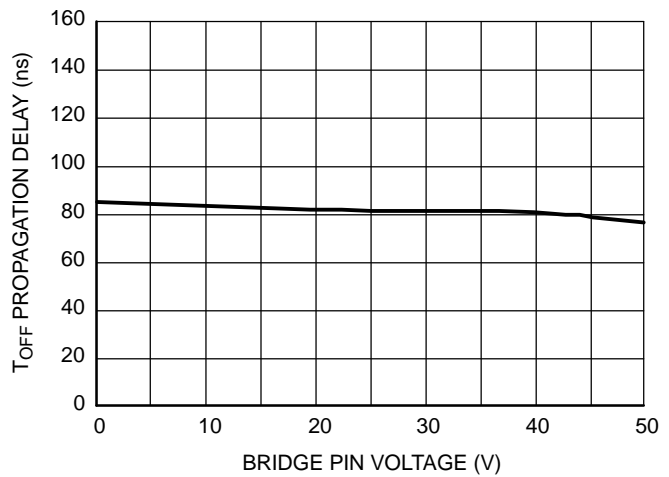

Figure 13. High Side Turn OFF Propagation Delay vs. V_{BRIDGE} Voltage

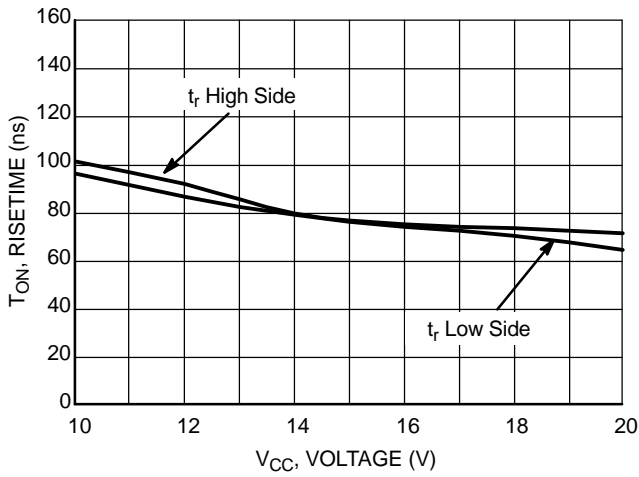

Figure 14. Turn ON Risetime vs. Supply Voltage ($V_{CC} = V_{BOOT}$)

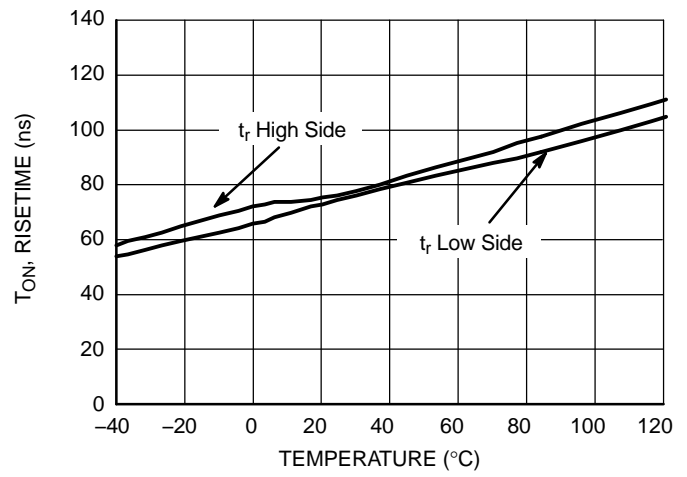

Figure 15. Turn ON Risetime vs. Temperature

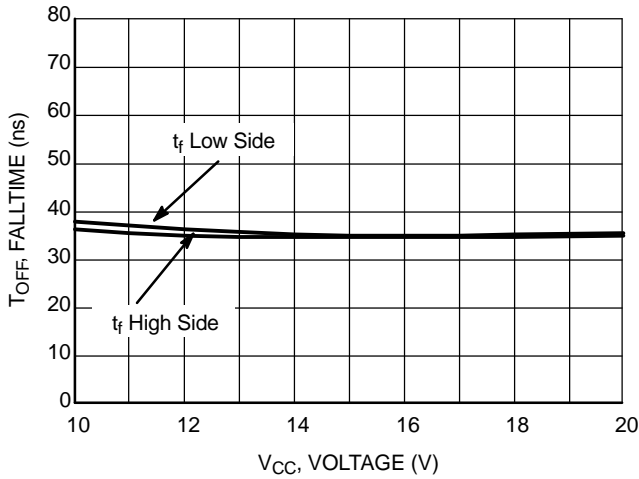

Figure 16. Turn OFF Falltime vs. Supply Voltage ($V_{CC} = V_{BOOT}$)

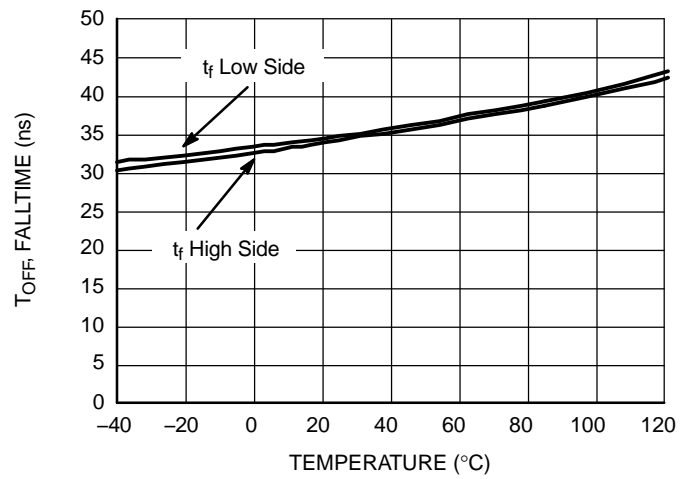

Figure 17. Turn OFF Falltime vs. Temperature

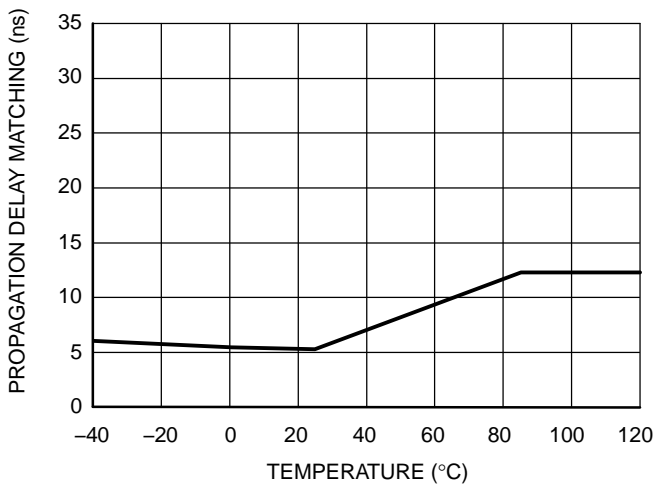

Figure 18. Propagation Delay Matching Between High Side and Low Side Driver vs. Temperature

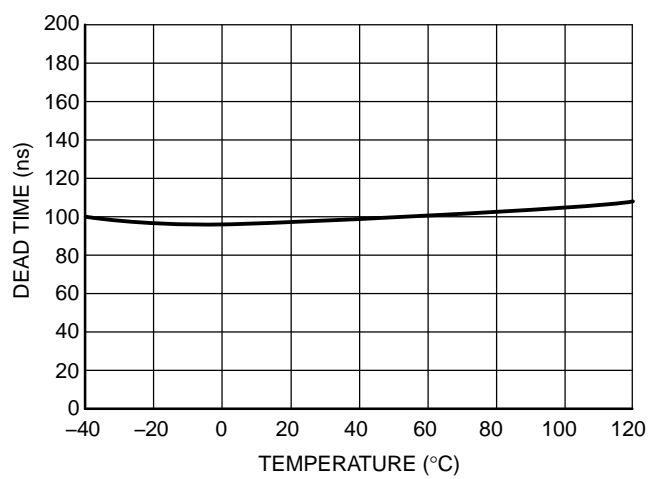

Figure 19. Dead Time vs. Temperature

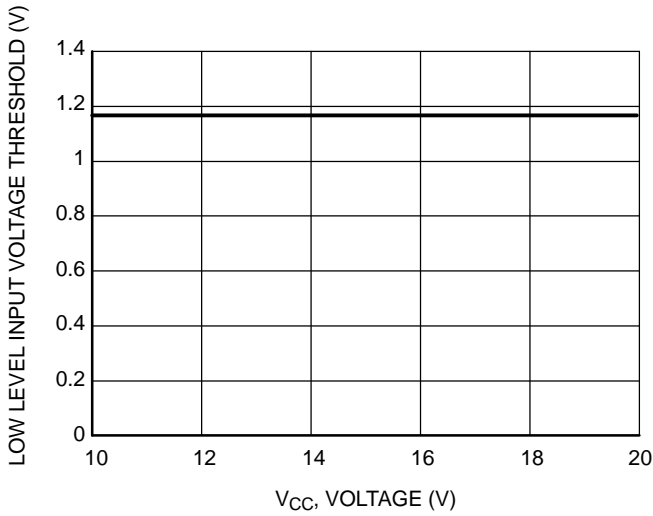

Figure 20. Low Level Input Voltage Threshold vs. Supply Voltage ($V_{CC} = V_{BOOT}$)

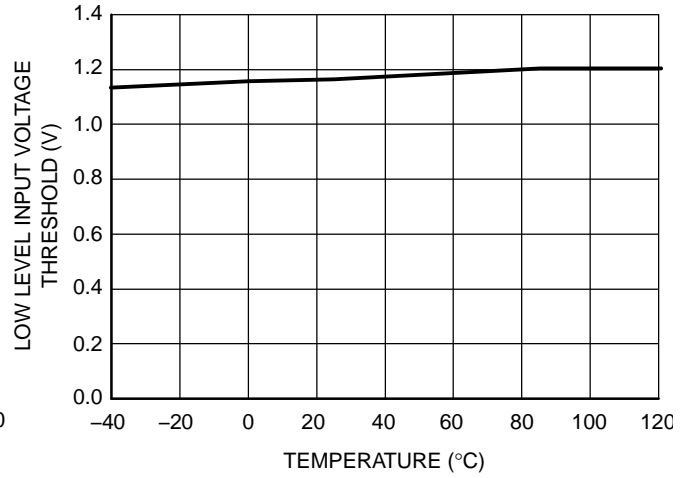

Figure 21. Low Level Input Voltage Threshold vs. Temperature

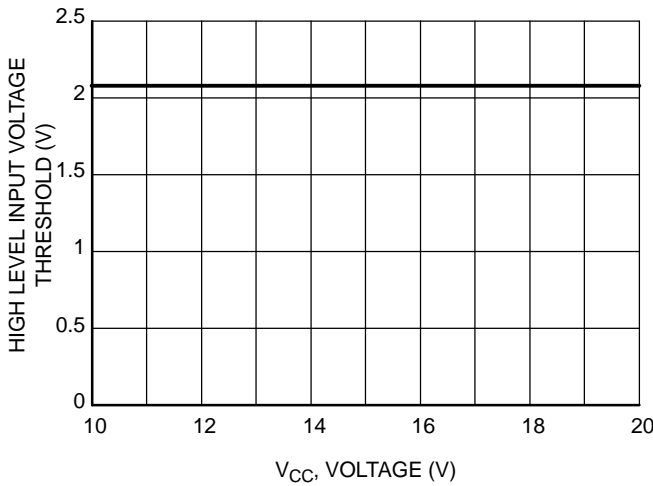

Figure 22. High Level Input Voltage Threshold vs. Supply Voltage ($V_{CC} = V_{BOOT}$)

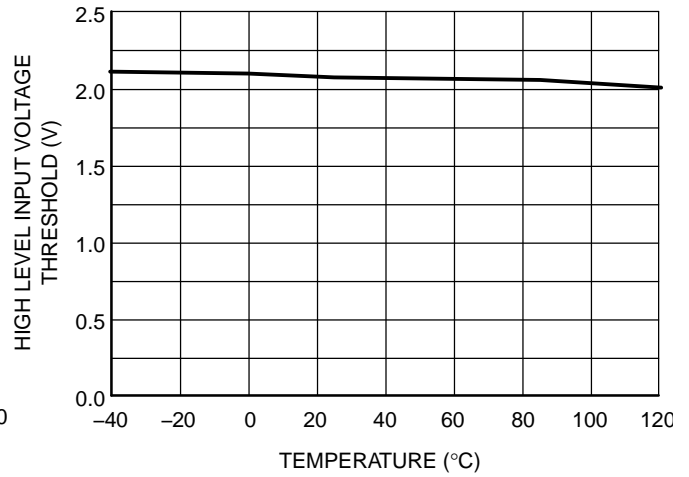

Figure 23. High Level Input Voltage Threshold vs. Temperature

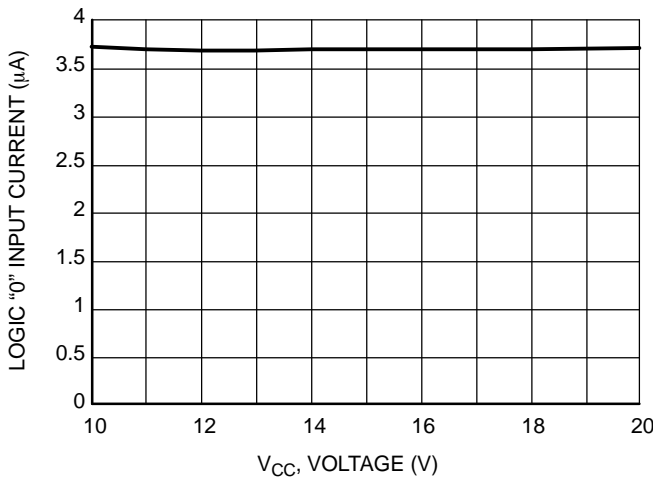

Figure 24. Logic "0" Input Current vs. Supply Voltage ($V_{CC} = V_{BOOT}$)

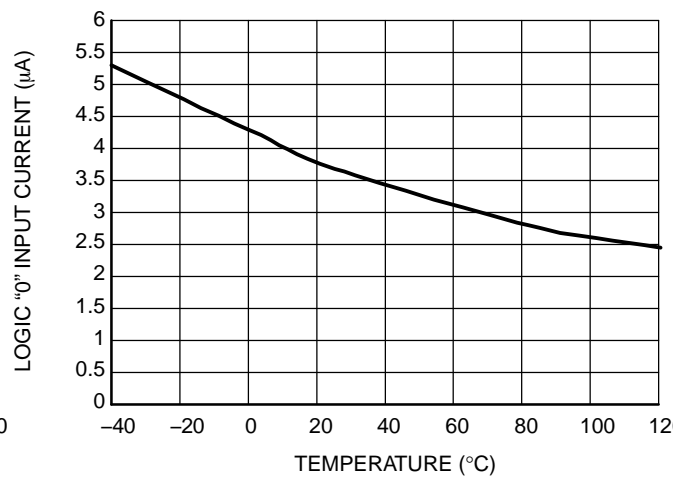

Figure 25. Logic "0" Input Current vs. Temperature

NCP5304

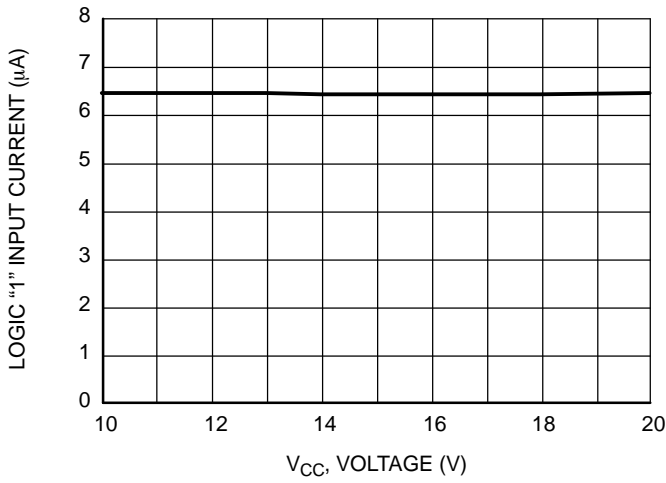

Figure 26. Logic "1" Input Current vs. Supply Voltage (V_{CC} = V_{BOOT})

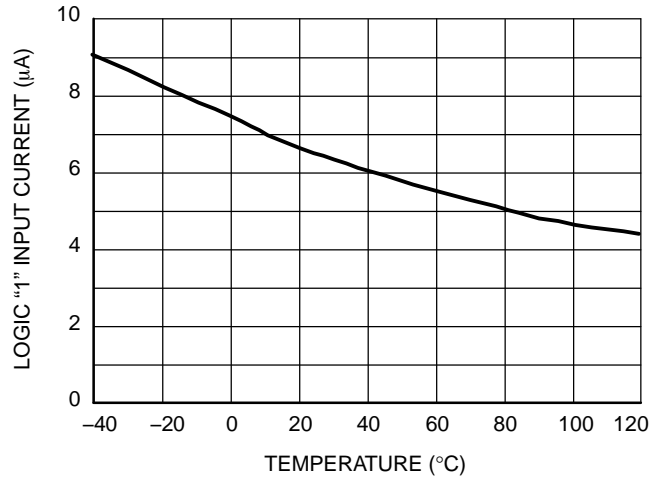

Figure 27. Logic "1" Input Current vs. Temperature

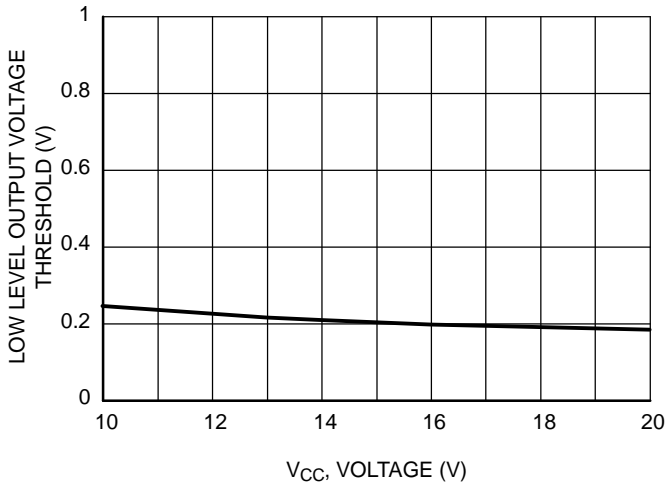

Figure 28. Low Level Output Voltage vs. Supply Voltage (V_{CC} = V_{BOOT})

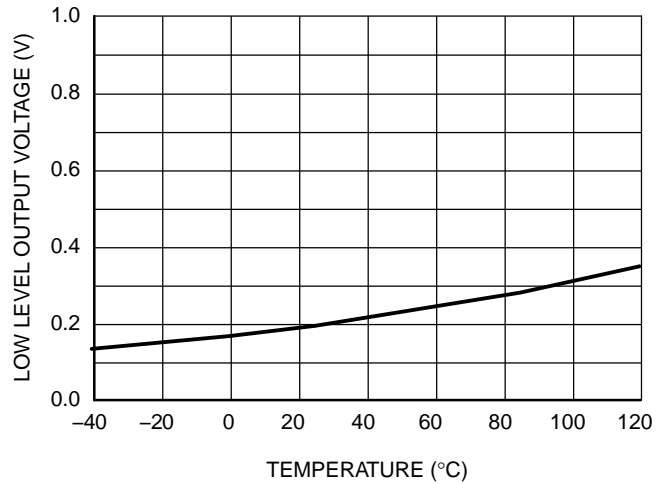

Figure 29. Low Level Output Voltage vs. Temperature

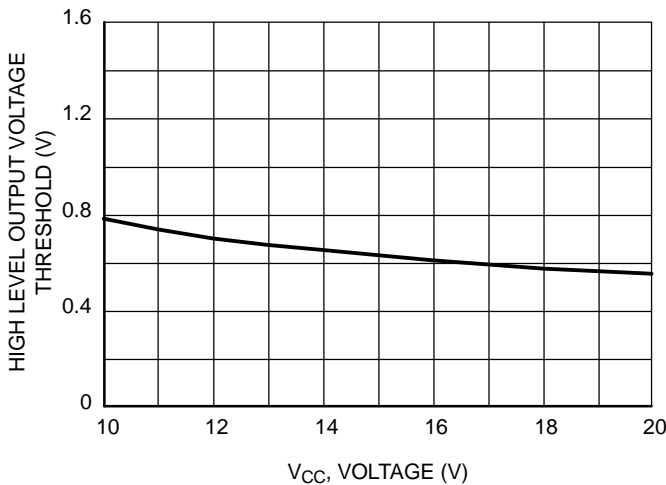

Figure 30. High Level Output Voltage vs. Supply Voltage (V_{CC} = V_{BOOT})

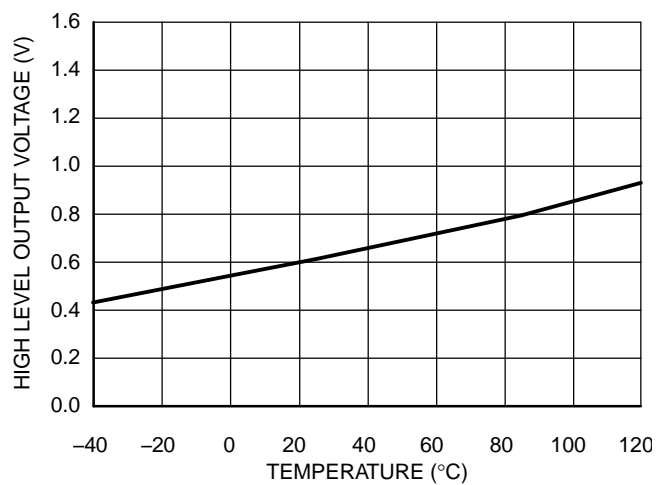

Figure 31. High Level Output Voltage vs. Temperature

NCP5304

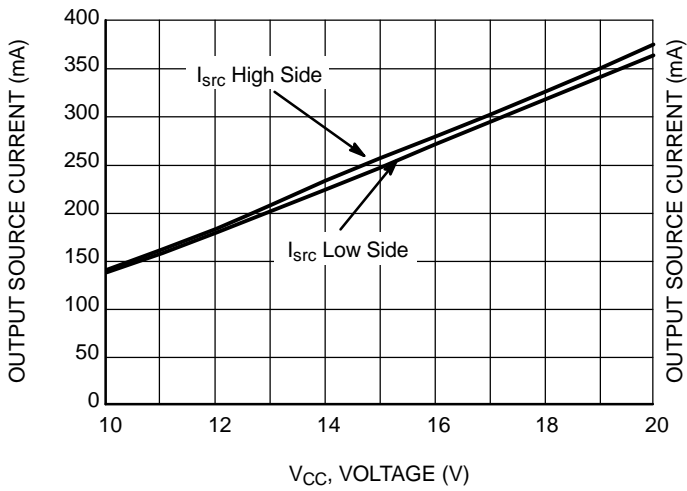

Figure 32. Output Source Current vs. Supply Voltage ($V_{CC} = V_{BOOT}$)

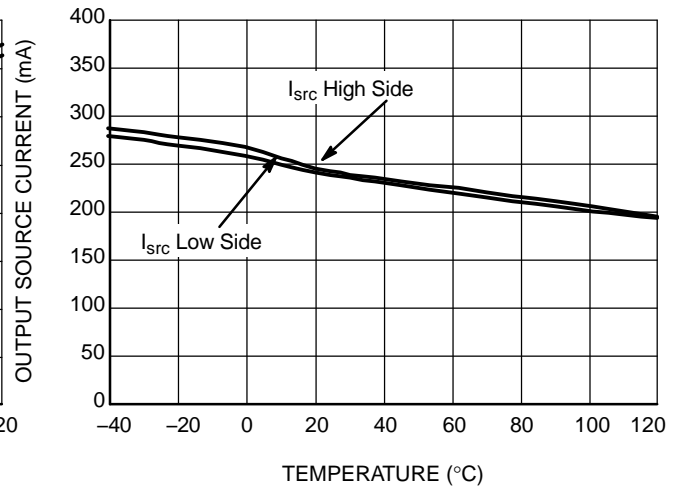

Figure 33. Output Source Current vs. Temperature

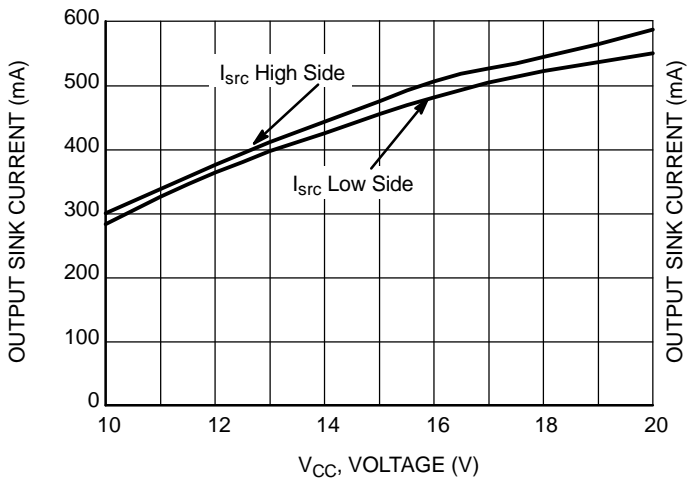

Figure 34. Output Sink Current vs. Supply Voltage ($V_{CC} = V_{BOOT}$)

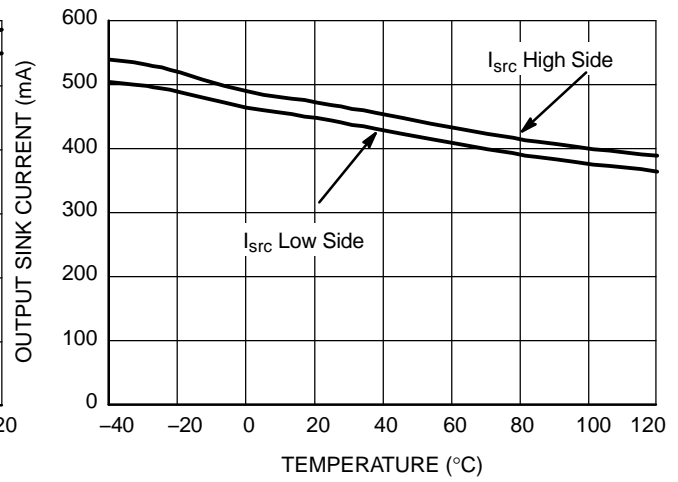

Figure 35. Output Sink Current vs. Temperature

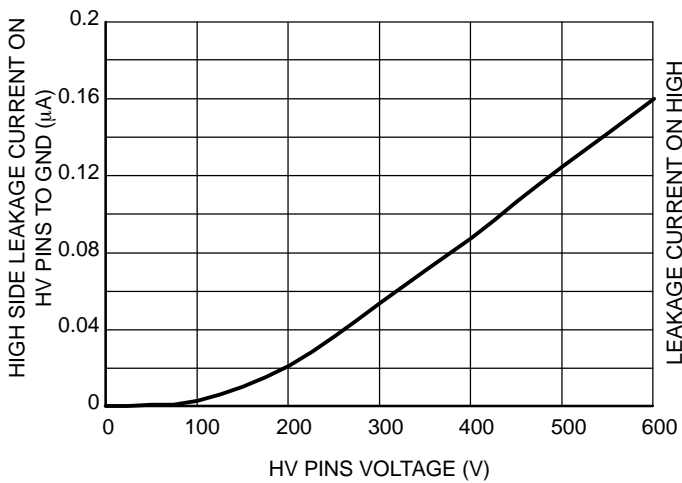

Figure 36. Leakage Current on High Voltage Pins (600 V) to Ground vs. V_{BRIDGE} Voltage ($V_{BRIDGE} = V_{BOOT} = V_{DRV_HI}$)

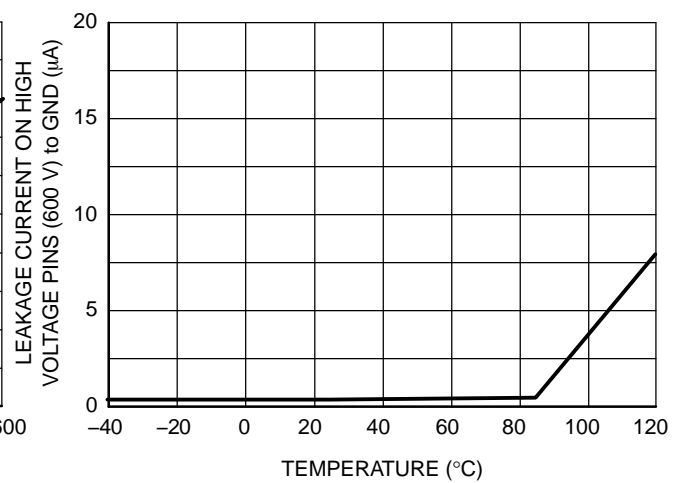

Figure 37. Leakage Current on High Voltage Pins (600 V) to Ground vs. Temperature ($V_{BRIDGE} = V_{BOOT} = V_{DRV_HI} = 600$ V)

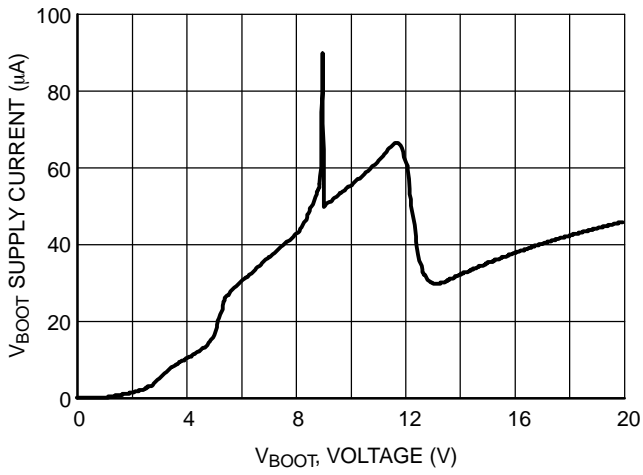

Figure 38. V_{BOOT} Supply Current vs. Bootstrap Supply Voltage

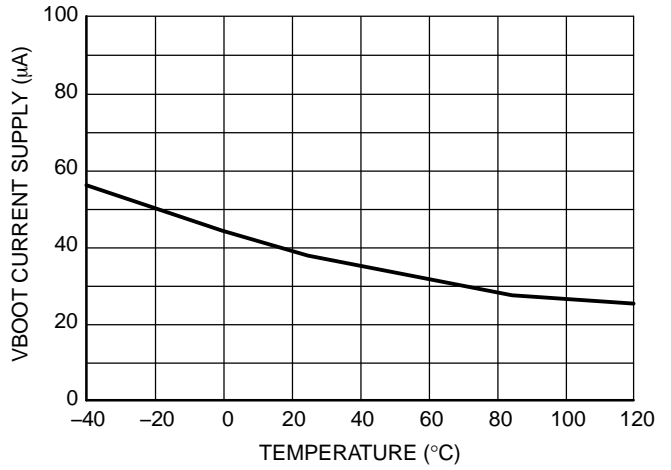

Figure 39. V_{BOOT} Supply Current vs. Temperature

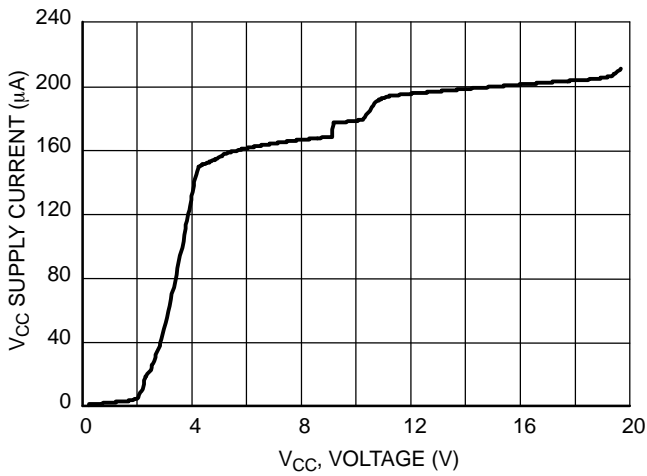

Figure 40. V_{CC} Supply Current vs. V_{CC} Supply Voltage

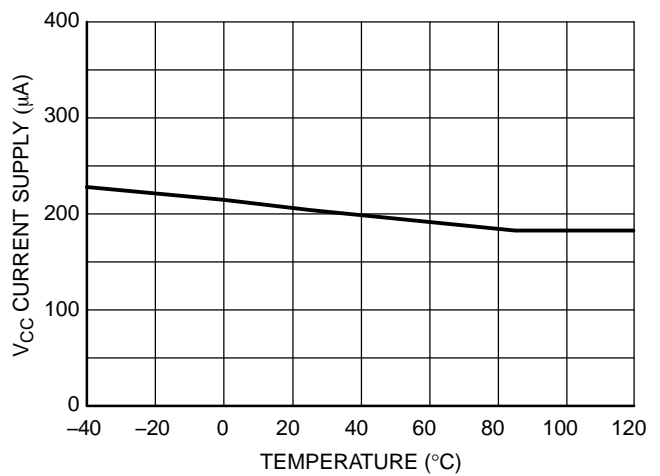

Figure 41. V_{CC} Supply Current vs. Temperature

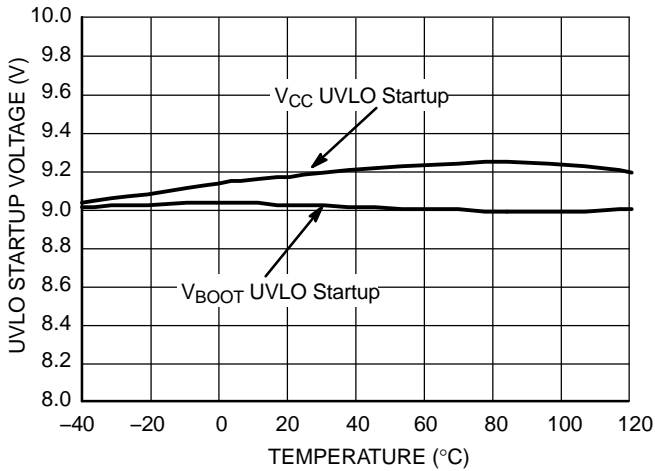

Figure 42. UVLO Startup Voltage vs. Temperature

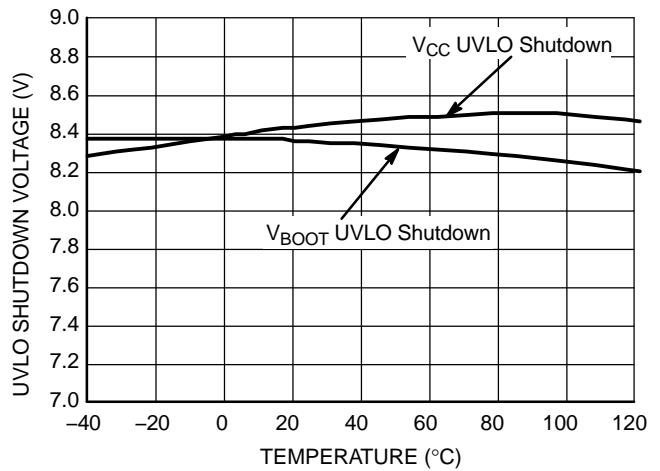

Figure 43. UVLO Shutdown Voltage vs. Temperature

NCP5304

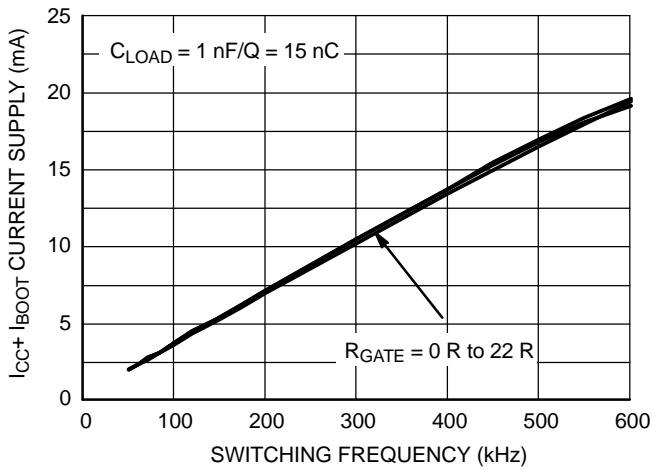

Figure 44. I_{CC1} Consumption vs. Switching Frequency with 15 nC Load on Each Driver @ $V_{CC} = 15 V$

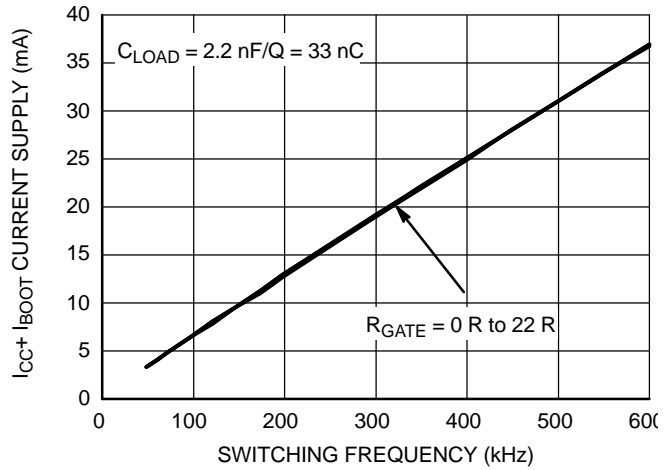

Figure 45. I_{CC1} Consumption vs. Switching Frequency with 33 nC Load on Each Driver @ $V_{CC} = 15 V$

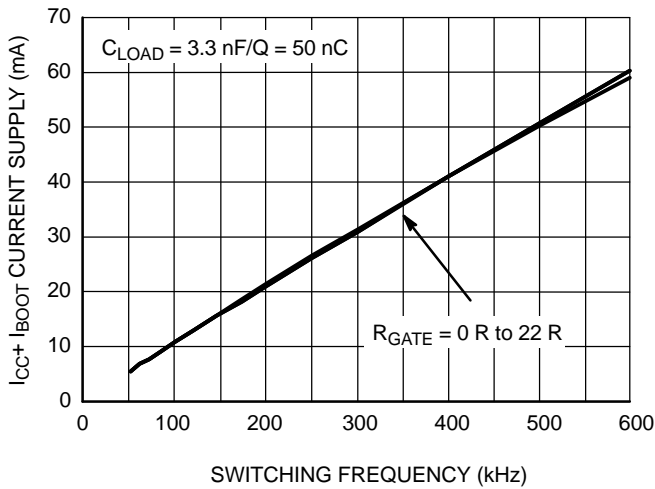

Figure 46. I_{CC1} Consumption vs. Switching Frequency with 50 nC Load on Each Driver @ $V_{CC} = 15 V$

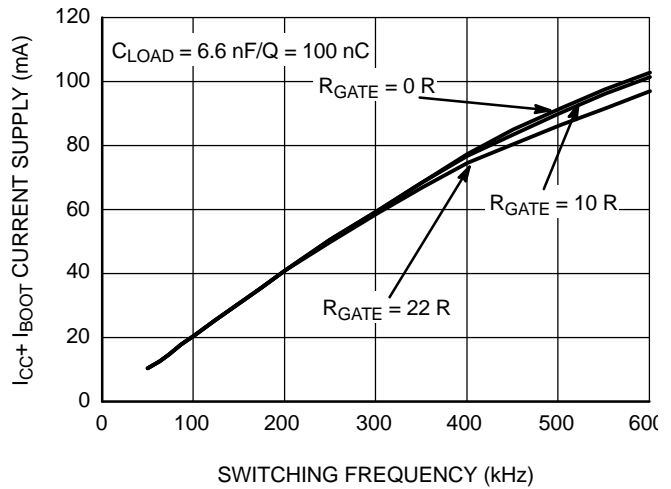

Figure 47. I_{CC1} Consumption vs. Switching Frequency with 100 nC Load on Each Driver @ $V_{CC} = 15 V$

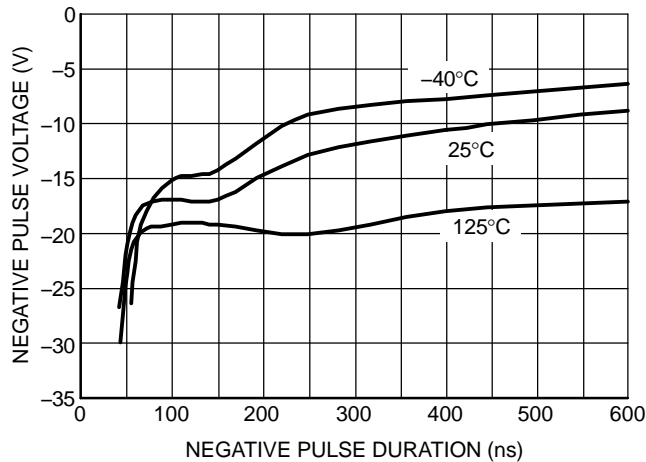

Figure 48. NCP5304, Negative Voltage Safe Operating Area on the Bridge Pin

APPLICATION INFORMATION

Negative Voltage Safe Operating Area

When the driver is used in a half bridge configuration, it is possible to see negative voltage appearing on the bridge pin (pin 6) during the power MOSFETs transitions. When the high-side MOSFET is switched off, the body diode of the low-side MOSFET starts to conduct. The negative voltage applied to the bridge pin thus corresponds to the forward voltage of the body diode. However, as pcb copper tracks and wire bonding introduce stray elements (inductance and capacitor), the maximum negative voltage of the bridge pin will combine the forward voltage and the oscillations created by the parasitic elements. As any CMOS device, the deep negative voltage of a selected pin can inject carriers into the substrate, leading to an erratic behavior of the concerned component. ON Semiconductor provides characterization data of its half-bridge driver to show the maximum negative voltage the driver can safely operate with. To prevent the negative injection, it is the designer duty to verify that the amount of negative voltage pertinent to his/her application does not exceed the characterization curve we provide, including some safety margin.

In order to estimate the maximum negative voltage accepted by the driver, this parameter has been characterized over full the temperature range of the component. A test fixture has been developed in which we purposely negatively bias the bridge pin during the freewheel period of a buck converter. When the upper gate voltage shows signs of an erratic behavior, we consider the limit has been reached.

Figure 48, illustrates the negative voltage safe operating area. Its interpretation is as follows: assume a negative 10 V pulse featuring a 100 ns width is applied on the bridge pin, the driver will work correctly over the whole die temperature range. Should the pulse swing to -20 V, keeping the same width of 100 ns, the driver will not work properly or will be damaged for temperatures below 125°C .

Summary:

- If the negative pulse characteristic (negative voltage level & pulse width) is above the curves the driver runs in safe operating area.
- If the negative pulse characteristic (negative voltage level and pulse width) is below one or all curves the driver will NOT run in safe operating area.

Note, each curve of the Figure 48 represents the negative voltage and width level where the driver starts to fail at the corresponding die temperature.

If in the application the bridge pin is too close of the safe operating limit, it is possible to limit the negative voltage to the bridge pin by inserting one resistor and one diode as follows:

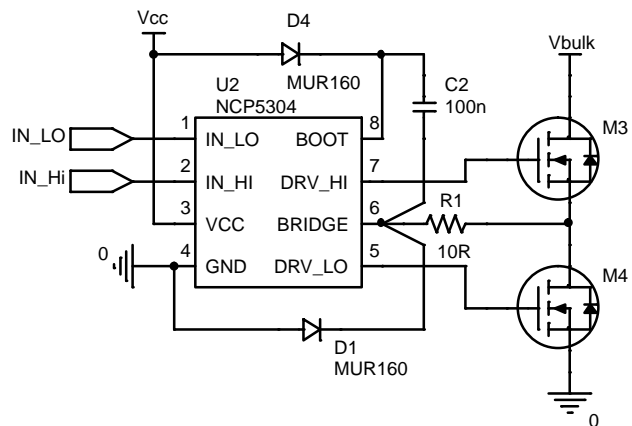

Figure 49. R1 and D1 Improves the Robustness of the Driver

R1 and D1 should be placed as close as possible of the driver. D1 should be connected directly between the bridge pin (pin 6) and the ground pin (pin 4). By this way the negative voltage applied to the bridge pin will be limited by D1 and R1 and will prevent any wrong behavior.

NCP5304

PACKAGE DIMENSIONS

8 LEAD PDIP CASE 626-05 ISSUE N

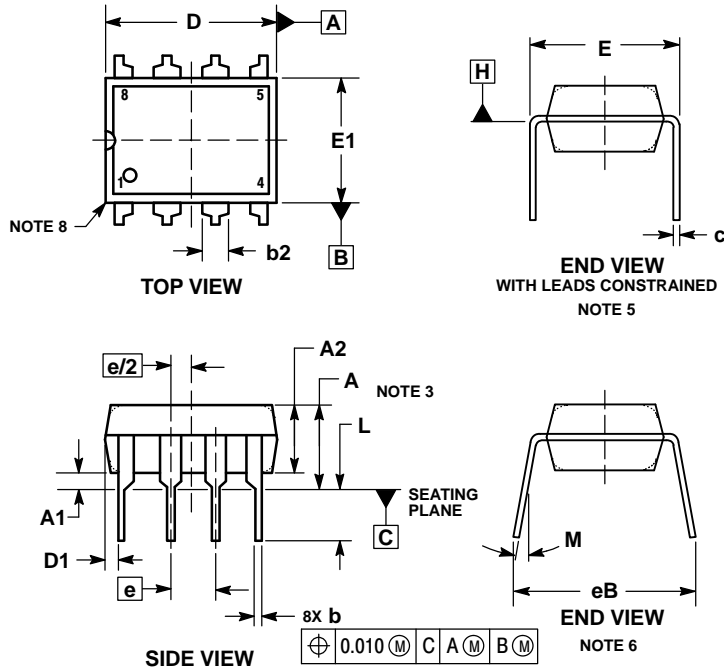

NOTES:

1. DIMENSIONING AND TOLERANCING PER ASME Y14.5M, 1994.
2. CONTROLLING DIMENSION: INCHES.
3. DIMENSIONS A, A1 AND L ARE MEASURED WITH THE PACKAGE SEATED IN JEDEC SEATING PLANE GAUGE GS-3.
4. DIMENSIONS D, D1 AND E1 DO NOT INCLUDE MOLD FLASH OR PROTRUSIONS. MOLD FLASH OR PROTRUSIONS ARE NOT TO EXCEED 0.10 INCH.
5. DIMENSION E IS MEASURED AT A POINT 0.015 BELOW DATUM PLANE H WITH THE LEADS CONSTRAINED PERPENDICULAR TO DATUM C.
6. DIMENSION E3 IS MEASURED AT THE LEAD TIPS WITH THE LEADS UNCONSTRAINED.
7. DATUM PLANE H IS COINCIDENT WITH THE BOTTOM OF THE LEADS, WHERE THE LEADS EXIT THE BODY.
8. PACKAGE CONTOUR IS OPTIONAL (ROUNDED OR SQUARE CORNERS).

DIM	INCHES		MILLIMETERS	
	MIN	MAX	MIN	MAX
A	---	0.210	---	5.33
A1	0.015	---	0.38	---
A2	0.115	0.195	2.92	4.95
b	0.014	0.022	0.35	0.56
b2	0.060 TYP		1.52 TYP	
C	0.008	0.014	0.20	0.36
D	0.355	0.400	9.02	10.16
D1	0.005	---	0.13	---
E	0.300	0.325	7.62	8.26
E1	0.240	0.280	6.10	7.11
e	0.100 BSC		2.54 BSC	
eB	---	0.430	---	10.92
L	0.115	0.150	2.92	3.81
M	---	10°	---	10°

NCP5304

PACKAGE DIMENSIONS

SOIC-8 NB CASE 751-07 ISSUE AK

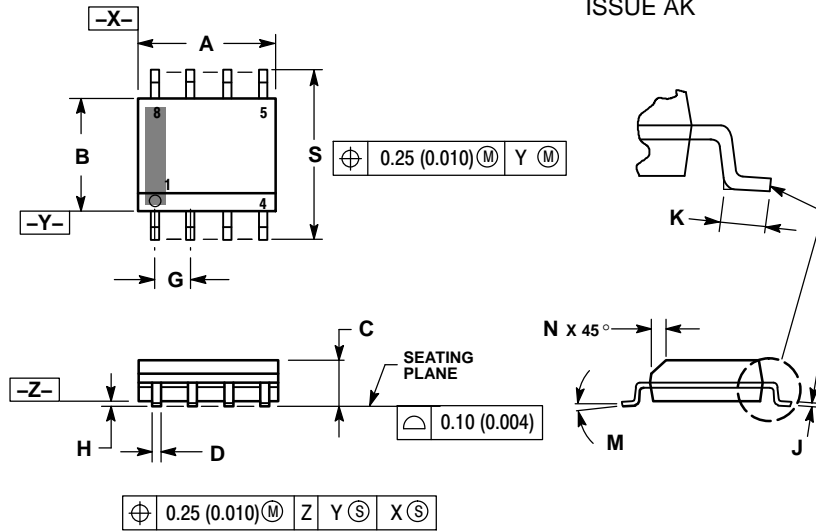

NOTES:

1. DIMENSIONING AND TOLERANCING PER ANSI Y14.5M, 1982.
2. CONTROLLING DIMENSION: MILLIMETER.
3. DIMENSION A AND B DO NOT INCLUDE MOLD PROTRUSION.
4. MAXIMUM MOLD PROTRUSION 0.15 (0.006) PER SIDE.
5. DIMENSION D DOES NOT INCLUDE DAMBAR PROTRUSION. ALLOWABLE DAMBAR PROTRUSION SHALL BE 0.127 (0.005) TOTAL IN EXCESS OF THE D DIMENSION AT MAXIMUM MATERIAL CONDITION.
6. 751-01 THRU 751-06 ARE OBSOLETE. NEW STANDARD IS 751-07.

DIM	MILLIMETERS		INCHES	
	MIN	MAX	MIN	MAX
A	4.80	5.00	0.189	0.197
B	3.80	4.00	0.150	0.157
C	1.35	1.75	0.053	0.069
D	0.33	0.51	0.013	0.020
G	1.27 BSC		0.050 BSC	
H	0.10	0.25	0.004	0.010
J	0.19	0.25	0.007	0.010
K	0.40	1.27	0.016	0.050
M	0°	8°	0°	8°
N	0.25	0.50	0.010	0.020
S	5.80	6.20	0.228	0.244

SOLDERING FOOTPRINT*

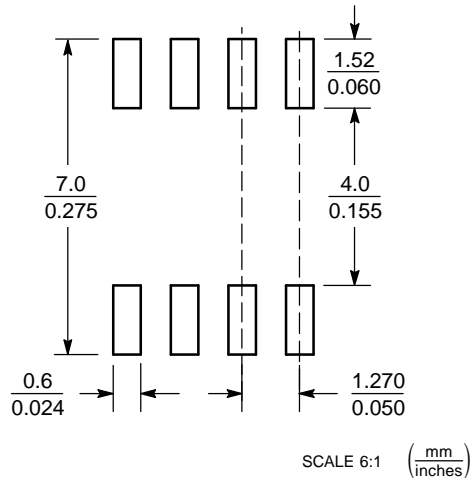

*For additional information on our Pb-Free strategy and soldering details, please download the ON Semiconductor Soldering and Mounting Techniques Reference Manual, SOLDERRM/D.

ON Semiconductor and the are registered trademarks of Semiconductor Components Industries, LLC (SCILLC) or its subsidiaries in the United States and/or other countries. SCILLC owns the rights to a number of patents, trademarks, copyrights, trade secrets, and other intellectual property. A listing of SCILLC's product/patent coverage may be accessed at www.onsemi.com/site/pdf/Patent-Marking.pdf. SCILLC reserves the right to make changes without further notice to any products herein. SCILLC makes no warranty, representation or guarantee regarding the suitability of its products for any particular purpose, nor does SCILLC assume any liability arising out of the application or use of any product or circuit, and specifically disclaims any and all liability, including without limitation special, consequential or incidental damages. "Typical" parameters which may be provided in SCILLC data sheets and/or specifications can and do vary in different applications and actual performance may vary over time. All operating parameters, including "Typicals" must be validated for each customer application by customer's technical experts. SCILLC does not convey any license under its patent rights nor the rights of others. SCILLC products are not designed, intended, or authorized for use as components in systems intended for surgical implant into the body, or other applications intended to support or sustain life, or for any other application in which the failure of the SCILLC product could create a situation where personal injury or death may occur. Should Buyer purchase or use SCILLC products for any such unintended or unauthorized application, Buyer shall indemnify and hold SCILLC and its officers, employees, subsidiaries, affiliates, and distributors harmless against all claims, costs, damages, and expenses, and reasonable attorney fees arising out of, directly or indirectly, any claim of personal injury or death associated with such unintended or unauthorized use, even if such claim alleges that SCILLC was negligent regarding the design or manufacture of the part. SCILLC is an Equal Opportunity/Affirmative Action Employer. This literature is subject to all applicable copyright laws and is not for resale in any manner.

PUBLICATION ORDERING INFORMATION

LITERATURE FULFILLMENT:
 Literature Distribution Center for ON Semiconductor
 P.O. Box 5163, Denver, Colorado 80217 USA
Phone: 303-675-2175 or 800-344-3860 Toll Free USA/Canada
Fax: 303-675-2176 or 800-344-3867 Toll Free USA/Canada
Email: orderlit@onsemi.com

N. American Technical Support: 800-282-9855 Toll Free USA/Canada
Europe, Middle East and Africa Technical Support:
 Phone: 421 33 790 2910
Japan Customer Focus Center
 Phone: 81-3-5817-1050

ON Semiconductor Website: www.onsemi.com
Order Literature: <http://www.onsemi.com/orderlit>

For additional information, please contact your local Sales Representative

Looking for pricing, stock, or lifecycle information?

Click below to explore more details on WIN SOURCE:

 [View NCP5304DR2G on WIN SOURCE](#)

 [ON Semiconductor](#) Information

Optimize Your Supply Chain with WIN SOURCE Solutions

-  Global Sourcing Solution
-  Obsolete Management
-  Cost Control Management
-  Shortage Management
-  Alternative Solution
-  Excess Inventory Management