



**THE DATASHEET OF
NCP304LSQ29T1G**



NCP304, NCP305

Voltage Detector Series

The NCP304 and NCP305 series are second generation ultra-low current voltage detectors. These devices are specifically designed for use as reset controllers in portable microprocessor based systems where extended battery life is paramount.

Each series features a highly accurate undervoltage detector with hysteresis which prevents erratic system reset operation as the comparator threshold is crossed.

The NCP304 series consists of complementary output devices that are available with either an active high or active low reset output. The NCP305 series has an open drain N-Channel output with an active low reset output.

The NCP304 and NCP305 device series are available in the SC-82AB package with standard undervoltage thresholds. Additional thresholds that range from 0.9 V to 4.9 V in 100 mV steps can be manufactured.

Features

- Quiescent Current of 1.0 μ A Typical
- High Accuracy Undervoltage Threshold of 2.0%
- Wide Operating Voltage Range of 0.8 V to 10 V
- Complementary or Open Drain Reset Output
- Active Low or Active High Reset Output
- NCV Prefix for Automotive and Other Applications Requiring Unique Site and Control Change Requirements; AEC-Q100 Qualified and PPAP Capable
- These Devices are Pb-Free and are RoHS Compliant

Typical Applications

- Microprocessor Reset Controller
- Low Battery Detection
- Power Fail Indicator
- Battery Backup Detection



This device contains 38 active transistors.

* The representative block diagram depicts active low reset output 'L' suffix devices. The comparator input is interchanged for the active high output 'H' suffix devices.



This device contains 37 active transistors.

Figure 1. Representative Block Diagrams



ON Semiconductor®

www.onsemi.com



SC-82AB
SQ SUFFIX
CASE 419C

PIN CONNECTIONS AND MARKING DIAGRAM

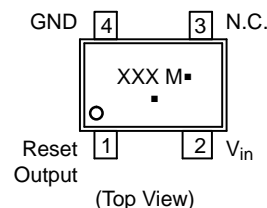

XXX = Specific Device Code
M = Date Code
▪ = Pb-Free Package

(Note: Microdot may be in either location)

ORDERING INFORMATION

See detailed ordering, marking and shipping information in the ordering information section on page 19 of this data sheet.

NCP304, NCP305

MAXIMUM RATINGS (Note 1)

| Rating | Symbol | Value | Unit |
|---|-----------------|------------------------------------|------|
| Input Power Supply Voltage (Pin 2) | V_{in} | 12 | V |
| Output Voltage (Pin 1) Complementary, NCP304 N-Channel Open Drain, NCP305 | V_{OUT} | -0.3 to $V_{in}+0.3$ -0.3 to 12 | V |
| Output Current (Pin 1) (Note 2) | I_{OUT} | 70 | mA |
| Thermal Resistance, Junction-to-Air | $R_{\theta JA}$ | 285 | °C/W |
| Maximum Junction Temperature | T_J | +125 | °C |
| Storage Temperature Range | T_{stg} | -55 to +150 | °C |
| Latchup Performance (Note 3) Positive Negative | $I_{LATCHUP}$ | 500 170 | mA |

Stresses exceeding those listed in the Maximum Ratings table may damage the device. If any of these limits are exceeded, device functionality should not be assumed, damage may occur and reliability may be affected.

- This device series contains ESD protection and exceeds the following tests:
Human Body Model 2000 V per MIL-STD-883, Method 3015.
Machine Model Method 200 V.

- The maximum package power dissipation limit must not be exceeded.

$$P_D = \frac{T_{J(max)} - T_A}{R_{\theta JA}}$$

- Maximum Ratings per JEDEC standard JESD78.

ELECTRICAL CHARACTERISTICS (For all values $T_A = 25^\circ\text{C}$, unless otherwise noted.)

| Characteristic | Symbol | Min | Typ | Max | Unit |
|---|---------------|----------------------------|-------------------------|-----------------|---------------|
| NCP304/5 – 0.9 | | | | | |
| Detector Threshold (Pin 2, V_{in} Decreasing) | V_{DET-} | 0.882 | 0.900 | 0.918 | V |
| Detector Threshold Hysteresis (Pin 2, V_{in} Increasing) | V_{HYS} | 0.027 | 0.045 | 0.063 | V |
| Supply Current (Pin 2) ($V_{in} = 0.8\text{ V}$) ($V_{in} = 2.9\text{ V}$) | I_{in} | - - | 0.8 - | 2.4 3.0 | μA |
| Maximum Operating Voltage (Pin 2) | $V_{in(max)}$ | - | - | 10 | V |
| Minimum Operating Voltage (Pin 2) ($T_A = -40^\circ\text{C}$ to 85°C) | $V_{in(min)}$ | - - | 0.55 0.65 | 0.70 0.80 | V |
| Reset Output Current (Pin 1, Active Low 'L' Suffix Devices) N-Channel Sink Current, NCP304, NCP305 ($V_{OUT} = 0.05\text{ V}$, $V_{in} = 0.70\text{ V}$) ($V_{OUT} = 0.50\text{ V}$, $V_{in} = 0.85\text{ V}$) P-Channel Source Current, NCP304 ($V_{OUT} = 2.4\text{ V}$, $V_{in} = 4.5\text{ V}$) | I_{OUT} | 0.01 0.05 1.0 | 0.05 0.50 2.0 | - - - | mA |
| Reset Output Current (Pin 1, Active High 'H' Suffix Devices) N-Channel Sink Current, NCP304, NCP305 ($V_{OUT} = 0.5\text{ V}$, $V_{in} = 1.5\text{ V}$) P-Channel Source Current, NCP304 ($V_{OUT} = 0.4\text{ V}$, $V_{in} = 0.7\text{ V}$) ($V_{OUT} = \text{GND}$, $V_{in} = 0.8\text{ V}$) | I_{OUT} | 1.05 0.011 0.014 | 2.5 0.04 0.08 | - - - | mA |
| Propagation Delay Input to Output (Figure 2) | | | | | μs |

- In the case of CMOS Output Type: The time interval between the rising edge of V_{DD} input pulse from 0.7 V to $(+V_{DET}) + 2.0\text{ V}$ and output voltage level becoming to $V_{DD}/2$. In the case of N-Channel Open Drain Output Type: Output pin is pulled up with a resistance of 470 k Ω to 5.0 V, the time interval between the rising edge of V_{DD} input pulse from 0.7 V to $(+V_{DET}) + 2.0\text{ V}$ and output voltage level becoming to 2.5 V.

NCP304, NCP305

ELECTRICAL CHARACTERISTICS (continued) (For all values $T_A = 25^\circ\text{C}$, unless otherwise noted.)

| Characteristic | Symbol | Min | Typ | Max | Unit |
|--|--|-------------------------------|-----------------------------|-----------------------------|---------------|
| NCP304/5 – 0.9 | | | | | |
| Complementary Output NCP304 Series Output Transition, High to Low (Note 4) | t_{pHL} | – | 18 | – | |
| Output Transition, Low to High (Note 4) | t_{pLH} | – | 6.0 | 60 | |
| N-Channel Open Drain NCP305 Series Output Transition, High to Low (Note 4) | t_{pHL} | – | 18 | – | |
| Output Transition, Low to High (Note 4) | t_{pLH} | – | – | 100 | |
| NCP304/5 – 1.8 | | | | | |
| Detector Threshold (Pin 2, V_{in} Decreasing) | V_{DET-} | 1.764 | 1.80 | 1.836 | V |
| Detector Threshold Hysteresis (Pin 2, V_{in} Increasing) | V_{HYS} | 0.054 | 0.090 | 0.126 | V |
| Supply Current (Pin 2) ($V_{in} = 1.7\text{ V}$) ($V_{in} = 3.8\text{ V}$) | I_{in} | – – | 0.8 1.0 | 2.4 3.0 | μA |
| Maximum Operating Voltage (Pin 2) | $V_{in(max)}$ | – | – | 10 | V |
| Minimum Operating Voltage (Pin 2) ($T_A = -40^\circ\text{C}$ to 85°C) | $V_{in(min)}$ | – – | 0.55 0.65 | 0.70 0.80 | V |
| Reset Output Current (Pin 1, Active Low 'L' Suffix Devices) N-Channel Sink Current, NCP304, NCP305 ($V_{OUT} = 0.05\text{ V}$, $V_{in} = 0.70\text{ V}$) ($V_{OUT} = 0.50\text{ V}$, $V_{in} = 1.5\text{ V}$) P-Channel Source Current, NCP304 ($V_{OUT} = 2.4\text{ V}$, $V_{in} = 4.5\text{ V}$) | I_{OUT} | 0.01 1.0 1.0 | 0.05 2.0 2.0 | – – – | mA |
| Reset Output Current (Pin 1, Active High 'H' Suffix Devices) N-Channel Sink Current, NCP304, NCP305 ($V_{OUT} = 0.5\text{ V}$, $V_{in} = 5.0\text{ V}$) P-Channel Source Current, NCP304 ($V_{OUT} = 0.4\text{ V}$, $V_{in} = 0.7\text{ V}$) ($V_{OUT} = \text{GND}$, $V_{in} = 1.5\text{ V}$) | I_{OUT} | 6.3 0.011 0.525 | 11 0.04 0.6 | – – – | mA |
| Propagation Delay Input to Output (Figure 2) Complementary Output NCP304 Series Output Transition, High to Low (Note 4) Output Transition, Low to High (Note 4) N-Channel Open Drain NCP305 Series Output Transition, High to Low (Note 4) Output Transition, Low to High (Note 4) | t_{pHL} t_{pLH} t_{pHL} t_{pLH} | – – – – | 14 15 14 – | – 60 – 100 | μs |
| NCP304/5 – 2.0 | | | | | |
| Detector Threshold (Pin 2, V_{in} Decreasing) | V_{DET-} | 1.960 | 2.00 | 2.040 | V |
| Detector Threshold Hysteresis (Pin 2, V_{in} Increasing) | V_{HYS} | 0.06 | 0.10 | 0.14 | V |
| Supply Current (Pin 2) ($V_{in} = 1.9\text{ V}$) ($V_{in} = 4.0\text{ V}$) | I_{in} | – – | 0.9 1.1 | 2.7 3.3 | μA |
| Maximum Operating Voltage (Pin 2) | $V_{in(max)}$ | – | – | 10 | V |
| Minimum Operating Voltage (Pin 2) ($T_A = -40^\circ\text{C}$ to 85°C) | $V_{in(min)}$ | – – | 0.55 0.65 | 0.70 0.80 | V |
| Reset Output Current (Pin 1, Active Low 'L' Suffix Devices) | I_{OUT} | | | | mA |

4. In the case of CMOS Output Type: The time interval between the rising edge of V_{DD} input pulse from 0.7 V to $(+V_{DET}) + 2.0\text{ V}$ and output voltage level becoming to $V_{DD}/2$. In the case of N-Channel Open Drain Output Type: Output pin is pulled up with a resistance of 470 k Ω to 5.0 V, the time interval between the rising edge of V_{DD} input pulse from 0.7 V to $(+V_{DET}) + 2.0\text{ V}$ and output voltage level becoming to 2.5 V.

NCP304, NCP305

ELECTRICAL CHARACTERISTICS (continued) (For all values $T_A = 25^\circ\text{C}$, unless otherwise noted.)

| Characteristic | Symbol | Min | Typ | Max | Unit |
|---|------------------------|----------------|--------------|--------------|---------------|
| NCP304/5 – 2.0 | | | | | |
| N-Channel Sink Current, NCP304, NCP305 ($V_{OUT} = 0.05\text{ V}$, $V_{in} = 0.70\text{ V}$) ($V_{OUT} = 0.50\text{ V}$, $V_{in} = 1.5\text{ V}$) | | 0.01 1.0 | 0.05 2.0 | – – | |
| P-Channel Source Current, NCP304 ($V_{OUT} = 2.4\text{ V}$, $V_{in} = 4.5\text{ V}$) | | 1.0 | 2.0 | – | |
| Reset Output Current (Pin 1, Active High 'H' Suffix Devices) | I_{OUT} | | | | mA |
| N-Channel Sink Current, NCP304, NCP305 ($V_{OUT} = 0.5\text{ V}$, $V_{in} = 5.0\text{ V}$) | | 6.3 | 11 | – | |
| P-Channel Source Current, NCP304 ($V_{OUT} = 0.4\text{ V}$, $V_{in} = 0.7\text{ V}$) ($V_{OUT} = \text{GND}$, $V_{in} = 1.5\text{ V}$) | | 0.011 0.525 | 0.04 0.6 | – – | |
| Propagation Delay Input to Output (Figure 2) | | | | | μs |
| Complementary Output NCP304 Series Output Transition, High to Low (Note 4) Output Transition, Low to High (Note 4) | t_{pHL} t_{pLH} | – – | 13 15 | – 60 | |
| N-Channel Open Drain NCP305 Series Output Transition, High to Low (Note 4) Output Transition, Low to High (Note 4) | t_{pHL} t_{pLH} | – – | 13 – | – 100 | |
| NCP304/5 – 2.7 | | | | | |
| Detector Threshold (Pin 2, V_{in} Decreasing) | V_{DET-} | 2.646 | 2.700 | 2.754 | V |
| Detector Threshold Hysteresis (Pin 2, V_{in} Increasing) | V_{HYS} | 0.081 | 0.135 | 0.189 | V |
| Supply Current (Pin 2) ($V_{in} = 2.6\text{ V}$) ($V_{in} = 4.7\text{ V}$) | I_{in} | – – | 0.9 1.1 | 2.7 3.3 | μA |
| Maximum Operating Voltage (Pin 2) | $V_{in(max)}$ | – | – | 10 | V |
| Minimum Operating Voltage (Pin 2) ($T_A = -40^\circ\text{C}$ to 85°C) | $V_{in(min)}$ | – – | 0.55 0.65 | 0.70 0.80 | V |
| Reset Output Current (Pin 1, Active Low 'L' Suffix Devices) | I_{OUT} | | | | mA |
| N-Channel Sink Current, NCP304, NCP305 ($V_{OUT} = 0.05\text{ V}$, $V_{in} = 0.70\text{ V}$) ($V_{OUT} = 0.50\text{ V}$, $V_{in} = 1.5\text{ V}$) | | 0.01 1.0 | 0.05 2.0 | – – | |
| P-Channel Source Current, NCP304 ($V_{OUT} = 2.4\text{ V}$, $V_{in} = 4.5\text{ V}$) | | 1.0 | 2.0 | – | |
| Reset Output Current (Pin 1, Active High 'H' Suffix Devices) | I_{OUT} | | | | mA |
| N-Channel Sink Current, NCP304, NCP305 ($V_{OUT} = 0.5\text{ V}$, $V_{in} = 5.0\text{ V}$) | | 6.3 | 11 | – | |
| P-Channel Source Current, NCP304 ($V_{OUT} = 0.4\text{ V}$, $V_{in} = 0.7\text{ V}$) ($V_{OUT} = \text{GND}$, $V_{in} = 1.5\text{ V}$) | | 0.011 0.525 | 0.04 0.6 | – – | |
| Propagation Delay Input to Output (Figure 2) | | | | | μs |
| Complementary Output NCP304 Series Output Transition, High to Low (Note 4) Output Transition, Low to High (Note 4) | t_{pHL} t_{pLH} | – – | 12 19 | – 60 | |
| N-Channel Open Drain NCP305 Series Output Transition, High to Low (Note 4) Output Transition, Low to High (Note 4) | t_{pHL} t_{pLH} | – – | 12 – | – 100 | |

4. In the case of CMOS Output Type: The time interval between the rising edge of V_{DD} input pulse from 0.7 V to $(+V_{DET}) + 2.0\text{ V}$ and output voltage level becoming to $V_{DD}/2$. In the case of N-Channel Open Drain Output Type: Output pin is pulled up with a resistance of 470 k Ω to 5.0 V, the time interval between the rising edge of V_{DD} input pulse from 0.7 V to $(+V_{DET}) + 2.0\text{ V}$ and output voltage level becoming to 2.5 V.

NCP304, NCP305

ELECTRICAL CHARACTERISTICS (continued) (For all values $T_A = 25^\circ\text{C}$, unless otherwise noted.)

| Characteristic | Symbol | Min | Typ | Max | Unit |
|--|------------------------|----------------|-------------|----------|---------------|
| NCP304/5 – 3.0 | | | | | |
| P-Channel Source Current, NCP304 ($V_{OUT} = 0.4\text{ V}$, $V_{in} = 0.7\text{ V}$) ($V_{OUT} = \text{GND}$, $V_{in} = 1.5\text{ V}$) | | 0.011 0.525 | 0.04 0.6 | – – | |
| Propagation Delay Input to Output (Figure 2) | | | | | μs |
| Complementary Output NCP304 Series Output Transition, High to Low (Note 4) Output Transition, Low to High (Note 4) | t_{pHL} t_{pLH} | – – | 12 19 | – 60 | |
| N-Channel Open Drain NCP305 Series Output Transition, High to Low (Note 4) Output Transition, Low to High (Note 4) | t_{pHL} t_{pLH} | – – | 12 – | – 100 | |

NCP304/5 – 4.5

| | | | | | |
|--|------------------------|-----------------------|--------------------|--------------|---------------|
| Detector Threshold (Pin 2, V_{in} Decreasing) | V_{DET-} | 4.410 | 4.500 | 4.590 | V |
| Detector Threshold Hysteresis (Pin 2, V_{in} Increasing) | V_{HYS} | 0.135 | 0.225 | 0.315 | V |
| Supply Current (Pin 2) ($V_{in} = 4.34\text{ V}$) ($V_{in} = 6.5\text{ V}$) | I_{in} | – – | – – | 3.0 3.9 | μA |
| Maximum Operating Voltage (Pin 2) | $V_{in(max)}$ | – | – | 10 | V |
| Minimum Operating Voltage (Pin 2) ($T_A = -40^\circ\text{C}$ to 85°C) | $V_{in(min)}$ | – – | 0.55 0.65 | 0.70 0.80 | V |
| Reset Output Current (Pin 1, Active Low 'L' Suffix Devices) N-Channel Sink Current, NCP304, NCP305 ($V_{OUT} = 0.05\text{ V}$, $V_{in} = 0.70\text{ V}$) ($V_{OUT} = 0.50\text{ V}$, $V_{in} = 1.5\text{ V}$) P-Channel Source Current, NCP304 ($V_{OUT} = 5.9\text{ V}$, $V_{in} = 8.0\text{ V}$) | I_{OUT} | 0.01 1.0 1.5 | 0.05 2.0 3.0 | – – – | mA |
| Reset Output Current (Pin 1, Active High 'H' Suffix Devices) N-Channel Sink Current, NCP304, NCP305 ($V_{OUT} = 0.5\text{ V}$, $V_{in} = 5.0\text{ V}$) P-Channel Source Current, NCP304 ($V_{OUT} = 0.4\text{ V}$, $V_{in} = 0.7\text{ V}$) ($V_{OUT} = \text{GND}$, $V_{in} = 1.5\text{ V}$) | I_{OUT} | 6.3 0.011 0.525 | 11 0.04 0.6 | – – – | mA |
| Propagation Delay Input to Output (Figure 2) | | | | | μs |
| Complementary Output NCP304 Series Output Transition, High to Low (Note 4) Output Transition, Low to High (Note 4) | t_{pHL} t_{pLH} | – – | 10 21 | – 60 | |
| N-Channel Open Drain NCP305 Series Output Transition, High to Low (Note 4) Output Transition, Low to High (Note 4) | t_{pHL} t_{pLH} | – – | 10 – | – 100 | |

NCP304/5 – 4.7

| | | | | | |
|---|---------------|--------|------------|------------|---------------|
| Detector Threshold (Pin 2, V_{in} Decreasing) | V_{DET-} | 4.606 | 4.70 | 4.794 | V |
| Detector Threshold Hysteresis (Pin 2, V_{in} Increasing) | V_{HYS} | 0.141 | 0.235 | 0.329 | V |
| Supply Current (Pin 2) ($V_{in} = 4.54\text{ V}$) ($V_{in} = 6.7\text{ V}$) | I_{in} | – – | 1.1 1.3 | 3.0 3.9 | μA |
| Maximum Operating Voltage (Pin 2) | $V_{in(max)}$ | – | – | 10 | V |

4. In the case of CMOS Output Type: The time interval between the rising edge of V_{DD} input pulse from 0.7 V to $(+V_{DET}) + 2.0\text{ V}$ and output voltage level becoming to $V_{DD}/2$. In the case of N-Channel Open Drain Output Type: Output pin is pulled up with a resistance of 470 k Ω to 5.0 V, the time interval between the rising edge of V_{DD} input pulse from 0.7 V to $(+V_{DET}) + 2.0\text{ V}$ and output voltage level becoming to 2.5 V.

NCP304, NCP305

ELECTRICAL CHARACTERISTICS (continued) (For all values $T_A = 25^\circ\text{C}$, unless otherwise noted.)

| Characteristic | Symbol | Min | Typ | Max | Unit |
|--|--|-----------------------|---------------------|---------------------|---------------|
| NCP304/5 – 4.7 | | | | | |
| Minimum Operating Voltage (Pin 2) ($T_A = -40^\circ\text{C}$ to 85°C) | $V_{in(min)}$ | – – | 0.55 0.65 | 0.70 0.80 | V |
| Reset Output Current (Pin 1, Active Low ‘L’ Suffix Devices) N–Channel Sink Current, NCP304, NCP305 ($V_{OUT} = 0.05\text{ V}$, $V_{in} = 0.70\text{ V}$) ($V_{OUT} = 0.50\text{ V}$, $V_{in} = 1.5\text{ V}$) P–Channel Source Current, NCP304 ($V_{OUT} = 5.9\text{ V}$, $V_{in} = 8.0\text{ V}$) | I_{OUT} | 0.01 1.0 1.5 | 0.05 2.0 3.0 | – – – | mA |
| Reset Output Current (Pin 1, Active High ‘H’ Suffix Devices) N–Channel Sink Current, NCP304, NCP305 ($V_{OUT} = 0.5\text{ V}$, $V_{in} = 5.0\text{ V}$) P–Channel Source Current, NCP304 ($V_{OUT} = 0.4\text{ V}$, $V_{in} = 0.7\text{ V}$) ($V_{OUT} = \text{GND}$, $V_{in} = 1.5\text{ V}$) | I_{OUT} | 6.3 0.011 0.525 | 11 0.04 0.6 | – – – | mA |
| Propagation Delay Input to Output (Figure 2) Complementary Output NCP304 Series Output Transition, High to Low (Note 4) Output Transition, Low to High (Note 4) N–Channel Open Drain NCP305 Series Output Transition, High to Low (Note 4) Output Transition, Low to High (Note 4) | t_{pHL} t_{pLH} t_{pHL} t_{pLH} | – – – – | 10 21 10 – | – 60 – 100 | μs |

4. In the case of CMOS Output Type: The time interval between the rising edge of V_{DD} input pulse from 0.7 V to $(+V_{DET}) + 2.0\text{ V}$ and output voltage level becoming to $V_{DD}/2$. In the case of N–Channel Open Drain Output Type: Output pin is pulled up with a resistance of 470 k Ω to 5.0 V, the time interval between the rising edge of V_{DD} input pulse from 0.7 V to $(+V_{DET}) + 2.0\text{ V}$ and output voltage level becoming to 2.5 V.

NCP304, NCP305

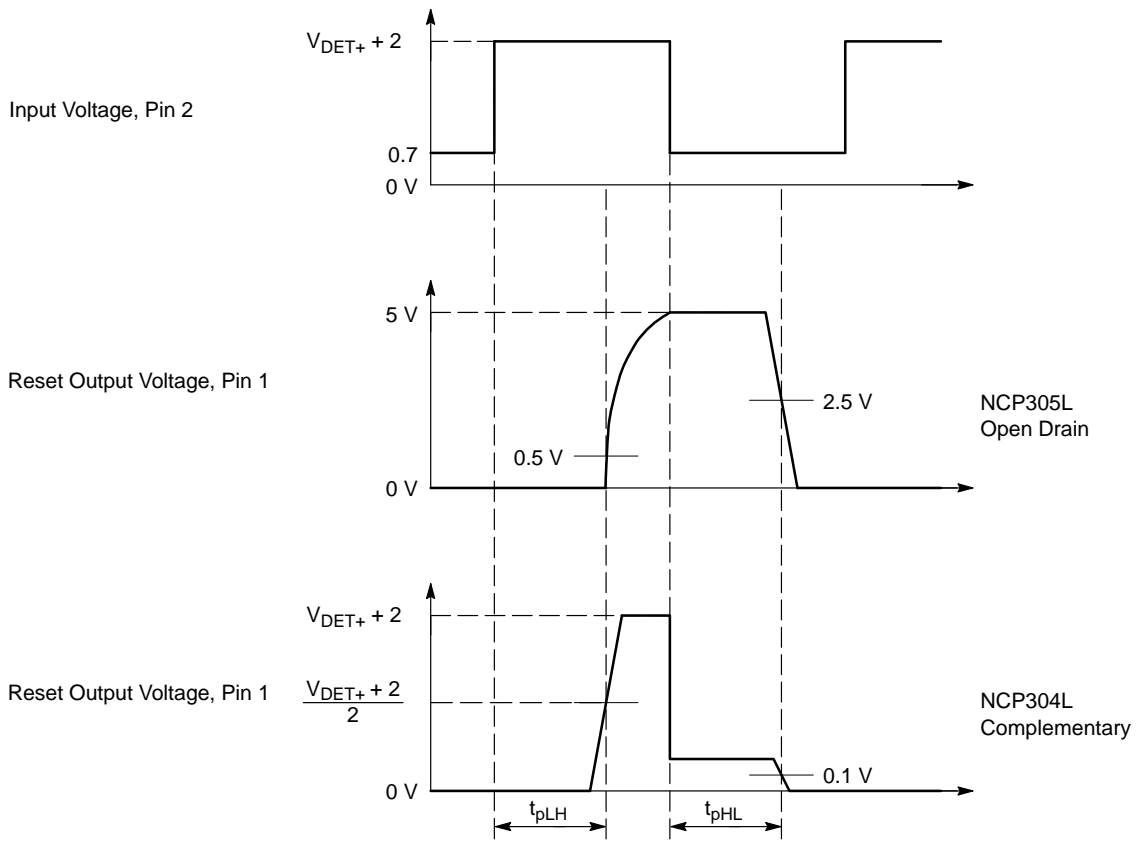

NCP304 and NCP305 series are measured with a 10 pF capacitive load. NCP305 has an additional 470 k pullup resistor connected from the reset output to +5.0 V. The reset output voltage waveforms are shown for the active low 'L' devices. The upper detector threshold, V_{DET+} is the sum of the lower detector threshold, V_{DET-} plus the input hysteresis, V_{HYS} .

Figure 2. Propagation Delay Measurement Conditions

NCP304, NCP305

Table 1. NCP304 SERIES ELECTRICAL CHARACTERISTIC TABLE FOR 0.9 – 4.9 V

| Part Number | Detector Threshold | | | Detector Threshold Hysteresis | | | Supply Current | | N-Chl Sink Current | | P-Channel Source Current |
|---------------|-----------------------|-----|-------|-------------------------------|-------|-------|-------------------------------|-------------------------------|--------------------------------|--------------------------------|--------------------------------|
| | | | | | | | V _{in} Low | V _{in} High | V _{in} Low | V _{in} High | |
| | V _{DET-} (V) | | | V _{HYS} (V) | | | I _{in} (μA) (Note 5) | I _{in} (μA) (Note 6) | I _{OUT} (mA) (Note 7) | I _{OUT} (mA) (Note 8) | I _{OUT} (mA) (Note 9) |
| | Min | Typ | Max | Min | Typ | Max | Typ | Typ | Typ | Typ | Typ |
| NCP304LSQ09T1 | 0.882 | 0.9 | 0.918 | 0.027 | 0.045 | 0.063 | 0.8 | 0.9 | 0.05 | 0.5 | 2.0 |
| NCP304LSQ15T1 | 1.470 | 1.5 | 1.530 | 0.045 | 0.075 | 0.105 | 0.9 | 1.1 | 0.05 | 0.5 | 2.0 |
| NCP304LSQ18T1 | 1.764 | 1.8 | 1.836 | 0.054 | 0.090 | 0.126 | | | | | |
| NCP304LSQ20T1 | 1.960 | 2.0 | 2.040 | 0.060 | 0.100 | 0.140 | | | | | |
| NCP304LSQ23T1 | 2.254 | 2.3 | 2.346 | 0.069 | 0.115 | 0.161 | | | | | |
| NCP304LSQ25T1 | 2.450 | 2.5 | 2.550 | 0.075 | 0.125 | 0.175 | | | | | |
| NCP304LSQ27T1 | 2.646 | 2.7 | 2.754 | 0.081 | 0.135 | 0.189 | | | | | |
| NCP304LSQ28T1 | 2.744 | 2.8 | 2.856 | 0.084 | 0.140 | 0.196 | | | | | |
| NCP304LSQ29T1 | 2.842 | 2.9 | 2.958 | 0.087 | 0.145 | 0.203 | | | | | |
| NCP304LSQ30T1 | 2.940 | 3.0 | 3.060 | 0.090 | 0.150 | 0.210 | 1.0 | 1.2 | 0.05 | 0.5 | 2.0 |
| NCP304LSQ31T1 | 3.038 | 3.1 | 3.162 | 0.093 | 0.155 | 0.217 | | | | | |
| NCP304LSQ33T1 | 3.234 | 3.3 | 3.366 | 0.099 | 0.165 | 0.231 | | | | | |
| NCP304LSQ37T1 | 3.626 | 3.7 | 3.774 | 0.111 | 0.185 | 0.259 | | | | | |
| NCP304LSQ38T1 | 3.724 | 3.8 | 3.876 | 0.114 | 0.190 | 0.266 | | | | | |
| NCP304LSQ40T1 | 3.920 | 4.0 | 4.080 | 0.120 | 0.200 | 0.280 | | | | | |
| NCP304LSQ42T1 | 4.116 | 4.2 | 4.284 | 0.126 | 0.210 | 0.294 | 1.1 | 1.3 | 0.05 | 0.5 | 2.0 |
| NCP304LSQ43T1 | 4.214 | 4.3 | 4.386 | 0.129 | 0.215 | 0.301 | | | | | |
| NCP304LSQ45T1 | 4.410 | 4.5 | 4.590 | 0.135 | 0.225 | 0.315 | | | | | |
| NCP304LSQ46T1 | 4.508 | 4.6 | 4.692 | 0.138 | 0.230 | 0.322 | | | | | |
| NCP304LSQ47T1 | 4.606 | 4.7 | 4.794 | 0.141 | 0.235 | 0.329 | | | | | |
| NCP304LSQ47T1 | 4.606 | 4.7 | 4.794 | 0.141 | 0.235 | 0.329 | | | | | |

5. Condition 1: 0.9 – 2.9 V, V_{in} = V_{DET-} – 0.10 V; 3.0 – 3.9 V, V_{in} = V_{DET-} – 0.13 V; 4.0 – 4.9 V, V_{in} = V_{DET-} – 0.16 V
6. Condition 2: 0.9 – 4.9 V, V_{in} = V_{DET-} + 2.0 V
7. Condition 3: 0.9 – 4.9 V, V_{in} = 0.7 V, V_{OUT} = 0.05 V, Active Low 'L' Suffix Devices
8. Condition 4: 0.9 – 1.0 V, V_{in} = 0.85 V, V_{OUT} = 0.5 V; 1.1 – 1.5 V, V_{in} = 1.0 V, V_{OUT} = 0.5 V; 1.6 – 4.9 V, V_{in} = 1.5 V, V_{OUT} = 0.5 V, Active Low 'L' Suffix Devices
9. Condition 5: 0.9 – 3.9 V, V_{in} = 4.5 V, V_{OUT} = 2.4 V; 4.0 – 4.9 V, V_{in} = 8.0 V, V_{OUT} = 5.9 V, Active Low 'L' Suffix Devices

Table 2. NCP304 SERIES ELECTRICAL CHARACTERISTIC TABLE FOR 0.9 – 4.9 V

| Part Number | Detector Threshold | | | Detector Threshold Hysteresis | | | Supply Current | | N-Channel Sink Current | P-Channel Source Current | |
|---------------|-----------------------|-----|-------|-------------------------------|-------|-------|--------------------------------|--------------------------------|---------------------------------|---------------------------------|---------------------------------|
| | | | | | | | V _{in} Low | V _{in} High | | V _{in} Low | V _{in} High |
| | V _{DET-} (V) | | | V _{HYS} (V) | | | I _{in} (μA) (Note 10) | I _{in} (μA) (Note 11) | I _{OUT} (mA) (Note 12) | I _{OUT} (mA) (Note 13) | I _{OUT} (mA) (Note 14) |
| | Min | Typ | Max | Min | Typ | Max | Typ | Typ | Typ | Typ | Typ |
| NCP304HSQ09T1 | 0.882 | 0.9 | 0.918 | 0.027 | 0.045 | 0.063 | 0.8 | 0.9 | 2.5 | 0.04 | 0.08 |
| NCP304HSQ18T1 | 1.764 | 1.8 | 1.836 | 0.054 | 0.090 | 0.126 | 0.9 | 1.1 | 2.5 | 0.04 | 0.08 |
| NCP304HSQ20T1 | 1.960 | 2.0 | 2.040 | 0.060 | 0.100 | 0.140 | | | | | |
| NCP304HSQ22T1 | 2.156 | 2.2 | 2.244 | 0.066 | 0.110 | 0.154 | | | | | |
| NCP304HSQ27T1 | 2.646 | 2.7 | 2.754 | 0.081 | 0.135 | 0.189 | | | | | |
| NCP304HSQ29T1 | 2.842 | 2.9 | 2.958 | 0.087 | 0.145 | 0.203 | | | | | |
| NCP304HSQ30T1 | 2.940 | 3.0 | 3.060 | 0.090 | 0.150 | 0.210 | | | | | |
| NCP304HSQ45T1 | 4.410 | 4.5 | 4.590 | 0.135 | 0.225 | 0.315 | 1.0 | 1.2 | 2.5 | 0.04 | 0.08 |
| NCP304HSQ47T1 | 4.606 | 4.7 | 4.794 | 0.141 | 0.235 | 0.329 | | | | | |

10. Condition 1: 0.9 – 2.9 V, V_{in} = V_{DET-} – 0.10 V; 3.0 – 3.9 V, V_{in} = V_{DET-} – 0.13 V; 4.0 – 4.9 V, V_{in} = V_{DET-} – 0.16 V
11. Condition 2: 0.9 – 4.9 V, V_{in} = V_{DET-} + 2.0 V
12. Condition 3: 0.9 – 1.4 V, V_{in} = 1.5 V, V_{OUT} = 0.5 V; 1.5 – 4.9 V, V_{in} = 5.0 V, V_{OUT} = 0.5 V, Active High 'H' Suffix Devices
13. Condition 4: 0.9 – 4.9 V, V_{in} = 0.7 V, V_{OUT} = 0.4 V, Active High 'H' Suffix Devices
14. Condition 5: 0.9 – 1.0 V, V_{in} = 0.8 V, V_{OUT} = GND; 1.1 – 1.5 V, V_{in} = 1.0 V, V_{OUT} = GND; 1.6 – 4.9 V, V_{in} = 1.5 V, V_{OUT} = GND, Active High 'H' Suffix Devices

NCP304, NCP305

Table 3. NCP305 SERIES ELECTRICAL CHARACTERISTIC TABLE FOR 0.9 – 4.9 V

| Part Number | Detector Threshold | | | Detector Threshold Hysteresis | | | Supply Current | | N-Channel Sink Current | | | | | |
|---------------|-----------------------|-----|-------|-------------------------------|-------|-------|-----------------------------------|-----------------------------------|------------------------------------|------------------------------------|-----|-----|------|-----|
| | | | | | | | V _{in} Low | V _{in} High | V _{in} Low | V _{in} High | | | | |
| | V _{DET-} (V) | | | V _{HYS} (V) | | | I _{in} (μA) (Note 15) | I _{in} (μA) (Note 16) | I _{OUT} (mA) (Note 17) | I _{OUT} (mA) (Note 18) | | | | |
| | Min | Typ | Max | Min | Typ | Max | Typ | Typ | Typ | Typ | | | | |
| NCP305LSQ09T1 | 0.882 | 0.9 | 0.918 | 0.027 | 0.045 | 0.063 | 0.8 | 0.9 | 0.05 | 0.5 | | | | |
| NCP305LSQ15T1 | 1.470 | 1.5 | 1.530 | 0.045 | 0.075 | 0.105 | | | | | | | | |
| NCP305LSQ16T1 | 1.568 | 1.6 | 1.632 | 0.048 | 0.080 | 0.112 | | | | | | | | |
| NCP305LSQ17T1 | 1.666 | 1.7 | 1.734 | 0.051 | 0.085 | 0.119 | | | | | | | | |
| NCP305LSQ18T1 | 1.764 | 1.8 | 1.836 | 0.054 | 0.090 | 0.126 | | | | | | | | |
| NCP305LSQ20T1 | 1.960 | 2.0 | 2.040 | 0.060 | 0.100 | 0.140 | 0.9 | 1.1 | 0.05 | 2.0 | | | | |
| NCP305LSQ22T1 | 2.156 | 2.2 | 2.244 | 0.066 | 0.110 | 0.154 | | | | | | | | |
| NCP305LSQ23T1 | 2.254 | 2.3 | 2.346 | 0.069 | 0.115 | 0.161 | | | | | | | | |
| NCP305LSQ24T1 | 2.352 | 2.4 | 2.448 | 0.072 | 0.120 | 0.168 | | | | | | | | |
| NCP305LSQ25T1 | 2.450 | 2.5 | 2.550 | 0.075 | 0.125 | 0.175 | | | | | | | | |
| NCP305LSQ26T1 | 2.548 | 2.6 | 2.652 | 0.078 | 0.130 | 0.182 | | | | | | | | |
| NCP305LSQ27T1 | 2.646 | 2.7 | 2.754 | 0.081 | 0.135 | 0.189 | | | | | | | | |
| NCP305LSQ28T1 | 2.744 | 2.8 | 2.856 | 0.084 | 0.140 | 0.196 | | | | | | | | |
| NCP305LSQ29T1 | 2.842 | 2.9 | 2.958 | 0.087 | 0.145 | 0.203 | | | | | | | | |
| NCP305LSQ30T1 | 2.940 | 3.0 | 3.060 | 0.090 | 0.150 | 0.210 | | | | | 1.0 | 1.2 | 0.05 | 2.0 |
| NCP305LSQ31T1 | 3.038 | 3.1 | 3.162 | 0.093 | 0.155 | 0.217 | | | | | | | | |
| NCP305LSQ32T1 | 3.136 | 3.2 | 3.264 | 0.096 | 0.160 | 0.224 | | | | | | | | |
| NCP305LSQ33T1 | 3.234 | 3.3 | 3.366 | 0.099 | 0.165 | 0.231 | | | | | | | | |
| NCP305LSQ34T1 | 3.332 | 3.4 | 3.468 | 0.102 | 0.170 | 0.238 | | | | | | | | |
| NCP305LSQ35T1 | 3.430 | 3.5 | 3.570 | 0.105 | 0.175 | 0.245 | | | | | | | | |
| NCP305LSQ36T1 | 3.528 | 3.6 | 3.672 | 0.108 | 0.180 | 0.252 | | | | | | | | |
| NCP305LSQ37T1 | 3.626 | 3.7 | 3.774 | 0.111 | 0.185 | 0.259 | | | | | | | | |
| NCP305LSQ40T1 | 3.920 | 4.0 | 4.080 | 0.120 | 0.200 | 0.280 | 1.1 | 1.3 | 0.05 | 2.0 | | | | |
| NCP305LSQ44T1 | 4.312 | 4.4 | 4.488 | 0.132 | 0.220 | 0.308 | | | | | | | | |
| NCP305LSQ45T1 | 4.410 | 4.5 | 4.590 | 0.135 | 0.225 | 0.315 | | | | | | | | |
| NCP305LSQ47T1 | 4.606 | 4.7 | 4.794 | 0.141 | 0.235 | 0.329 | | | | | | | | |
| NCP305LSQ49T1 | 4.802 | 4.9 | 4.998 | 0.147 | 0.245 | 0.343 | | | | | | | | |

15. Condition 1: 0.9 – 2.9 V, V_{in} = V_{DET-} – 0.10 V; 3.0 – 3.9 V, V_{in} = V_{DET-} – 0.13 V; 4.0 – 4.9 V, V_{in} = V_{DET-} – 0.16 V

16. Condition 2: 0.9 – 4.9 V, V_{in} = V_{DET-} + 2.0 V

17. Condition 3: 0.9 – 4.9 V, V_{in} = 0.7 V, V_{OUT} = 0.05 V, Active Low 'L' Suffix Devices

18. Condition 4: 0.9 – 1.0 V, V_{in} = 0.85 V, V_{OUT} = 0.5 V; 1.1 – 1.5 V, V_{in} = 1.0 V, V_{OUT} = 0.5 V; 1.6 – 4.9 V, V_{in} = 1.5 V, V_{OUT} = 0.5 V, Active Low 'L' Suffix Devices

NCP304, NCP305



**Figure 3. NCP304/5 Series 0.9 V
Detector Threshold Voltage vs. Temperature**

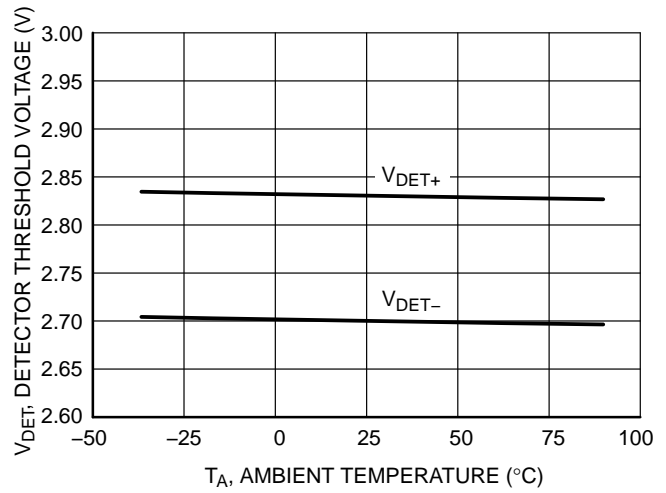

**Figure 4. NCP304/5 Series 2.7 V
Detector Threshold Voltage vs. Temperature**



**Figure 5. NCP304/5 Series 4.5 V
Detector Threshold Voltage vs. Temperature**

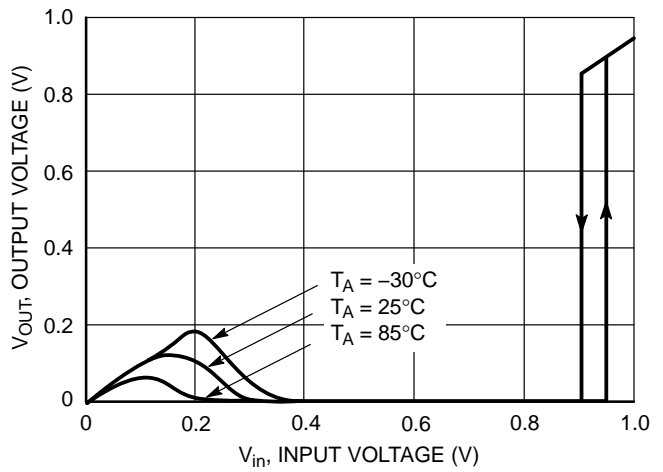

**Figure 6. NCP304L/5L Series 0.9 V
Reset Output Voltage vs. Input Voltage**



**Figure 7. NCP304L/5L Series 2.7 V
Reset Output Voltage vs. Input Voltage**

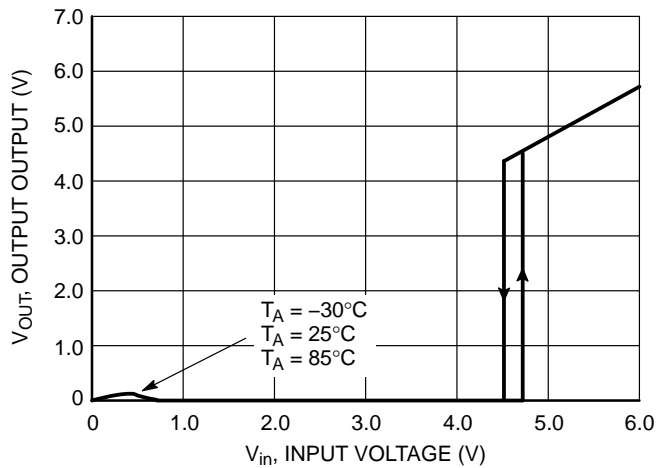

**Figure 8. NCP304L/5L Series 4.5 V
Reset Output Voltage vs. Input Voltage**

NCP304, NCP305



Figure 9. NCP304H/5H Series 2.7 V Reset Output Voltage vs. Input Voltage



Figure 10. NCP304H/5L Series 0.9 V Reset Output Sink Current vs. Output Voltage



Figure 11. NCP304H/5L Series 2.7 V Reset Output Sink Current vs. Output Voltage



Figure 12. NCP304H/5L Series 4.5 V Reset Output Sink Current vs. Output Voltage

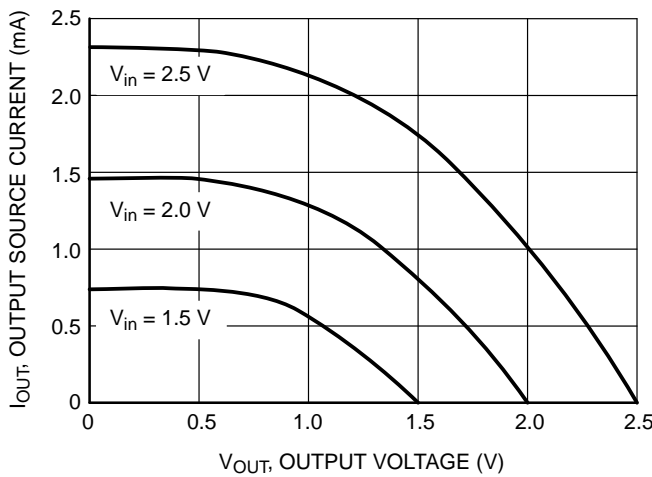

Figure 13. NCP304H Series 2.7 V Reset Output Source Current vs. Output Voltage

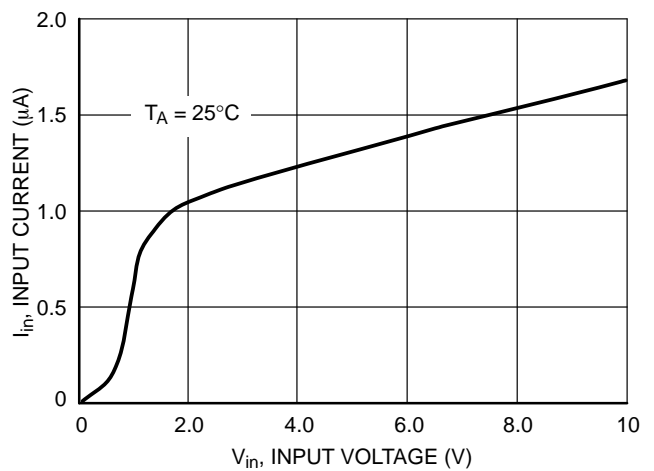

Figure 14. NCP304/5 Series 0.9 V Input Current vs. Input Voltage

NCP304, NCP305

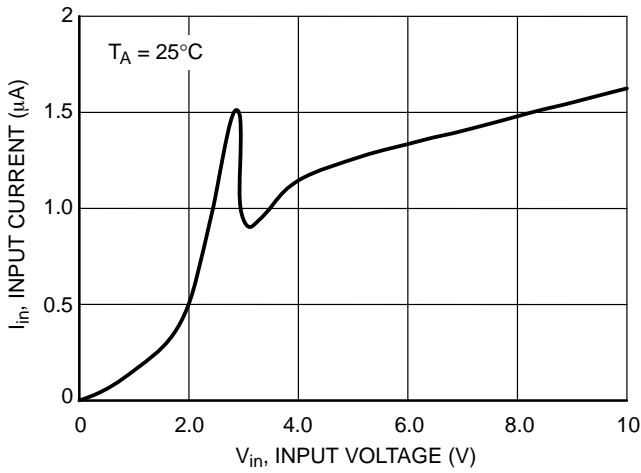

Figure 15. NCP304/5 Series 2.7 V Input Current vs. Input Voltage

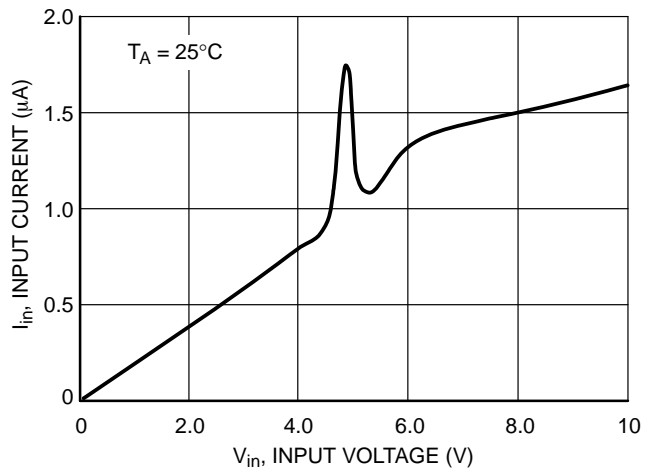

Figure 16. NCP304/5 Series 4.5 V Input Current vs. Input Voltage

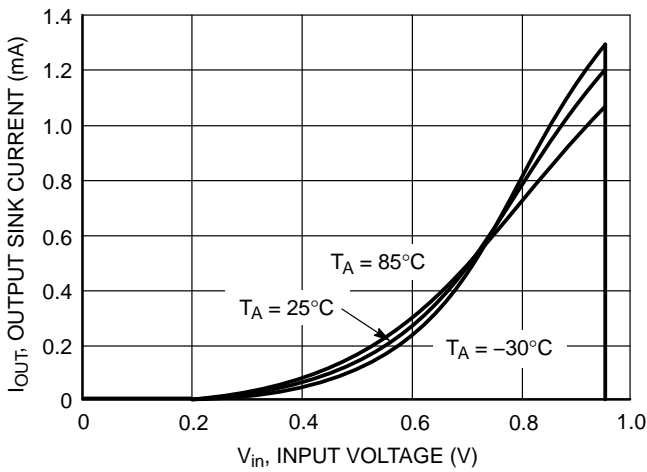

Figure 17. NCP304H/5L Series 0.9 V Reset Output Sink Current vs. Input Voltage

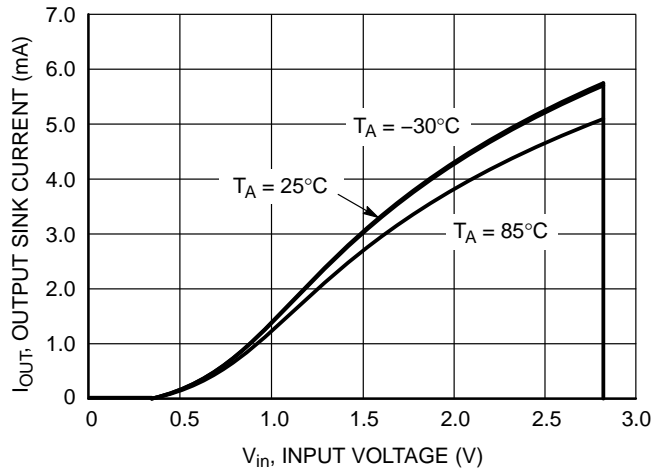

Figure 18. NCP304H/5L Series 2.7 V Reset Output Sink Current vs. Input Voltage

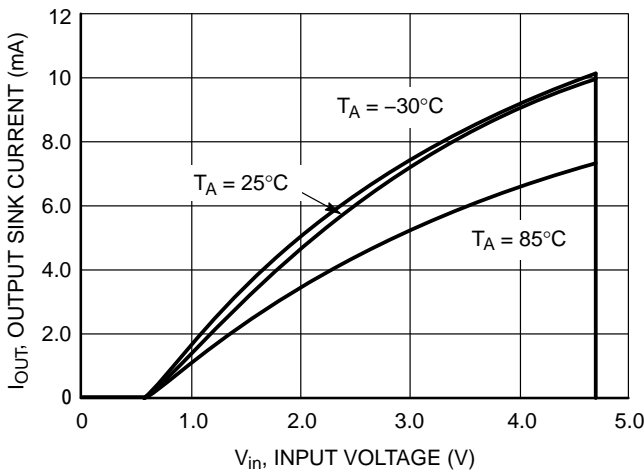

Figure 19. NCP304H/5L Series 4.5 V Reset Output Sink Current vs. Input Voltage

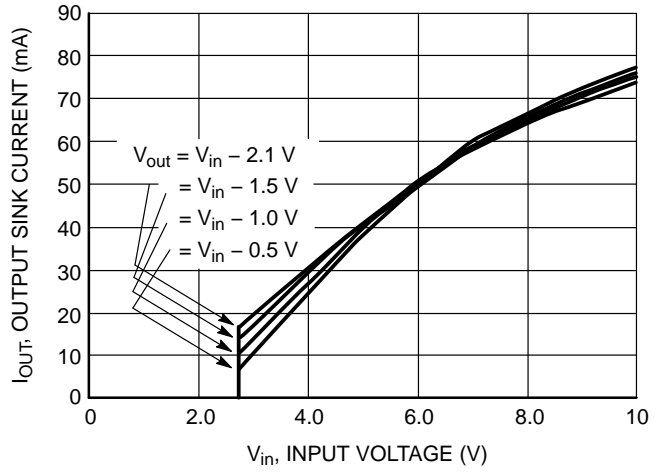

Figure 20. NCP304H/5H Series 2.7 V Reset Output Sink Current vs. Input Voltage

NCP304, NCP305

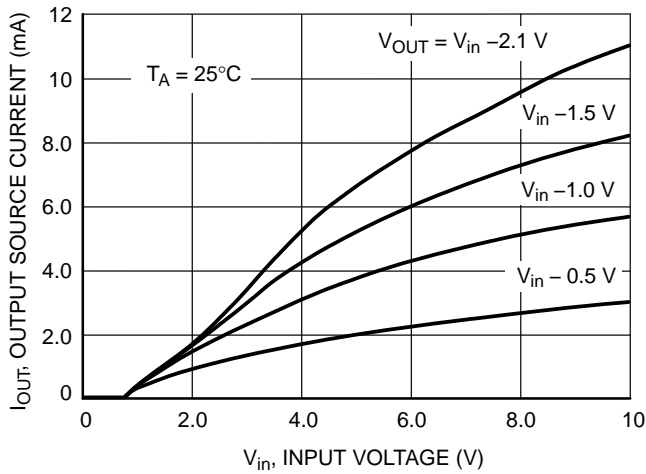

Figure 21. NCP304H Series 0.9 V
Reset Output Source Current vs. Input Voltage

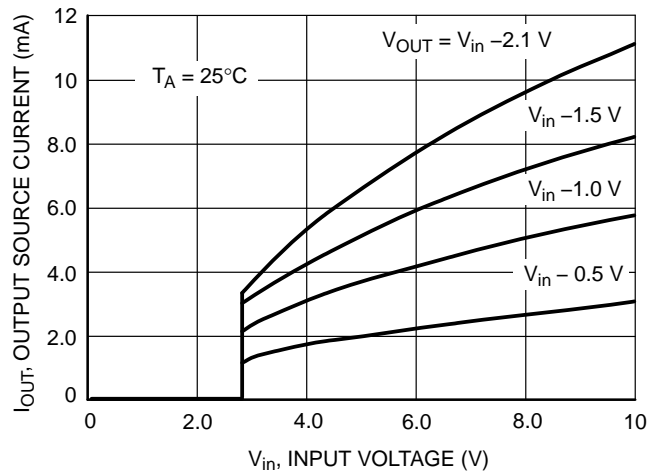

Figure 22. NCP304H Series 2.7 V
Reset Output Source Current vs. Input Voltage



Figure 23. NCP304H Series 4.5 V
Reset Output Source Current vs. Input Voltage

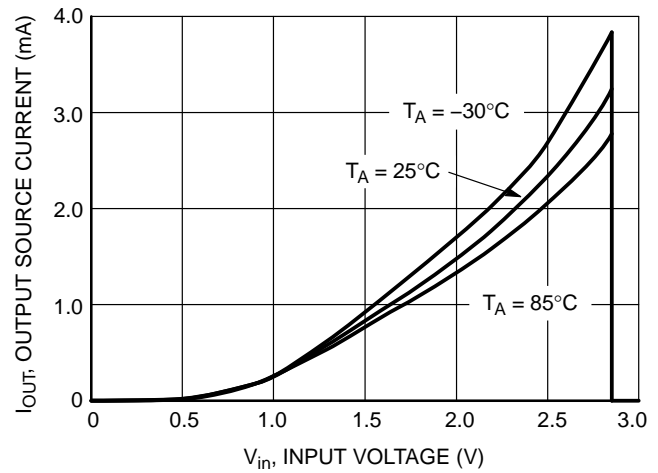

Figure 24. NCP304H Series 2.7 V
Reset Output Source Current vs. Input Voltage

NCP304, NCP305

OPERATING DESCRIPTION

The NCP304 and NCP305 series devices are second generation ultra-low current voltage detectors. Figures 25 and 26 show a timing diagram and a typical application. Initially consider that input voltage V_{in} is at a nominal level and it is greater than the voltage detector upper threshold (V_{DET+}), and the reset output (Pin 1) will be in the high state for active low devices, or in the low state for active high devices. If there is a power interruption and V_{in} becomes significantly deficient, it will fall below the lower detector threshold (V_{DET-}). This sequence of events causes the Reset output to be in the low state for active low devices, or in the

high state for active high devices. After completion of the power interruption, V_{in} will again return to its nominal level and become greater than the V_{DET+} . The voltage detector has built-in hysteresis to prevent erratic reset operation as the comparator threshold is crossed.

Although these device series are specifically designed for use as reset controllers in portable microprocessor based systems, they offer a cost-effective solution in numerous applications where precise voltage monitoring is required. Figure 26 through Figure 32 shows various application examples.

| "L" in Part Name | "H" in Part Name |
|---|---|
| Function: active Low Reset Output | Function: active High Reset Output |
| Input < V_{det-} , Reset Output is Low | Input < V_{det-} , Reset Output is High |
| Input > V_{det+} , Reset Output is High | Input > V_{det+} , Reset Output is Low |

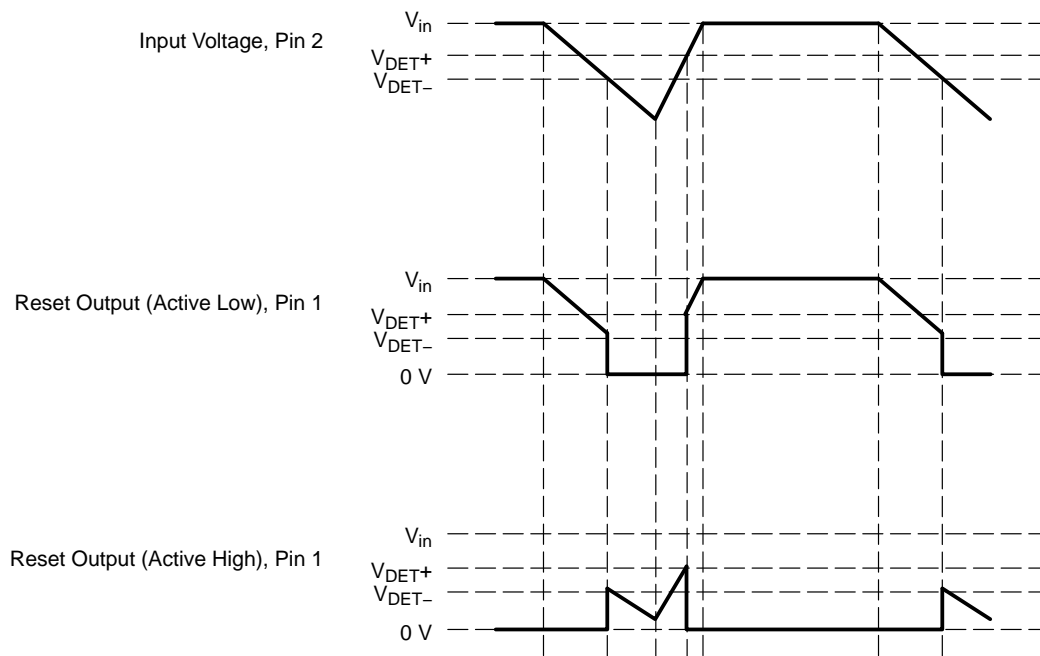

Figure 25. Timing Waveforms

NCP304, NCP305

APPLICATION CIRCUIT INFORMATION



Figure 26. Microprocessor Reset Circuit



Figure 27. Battery Charge Indicator



Figure 28. Dual Power Supply Undervoltage Supervision

NCP304, NCP305

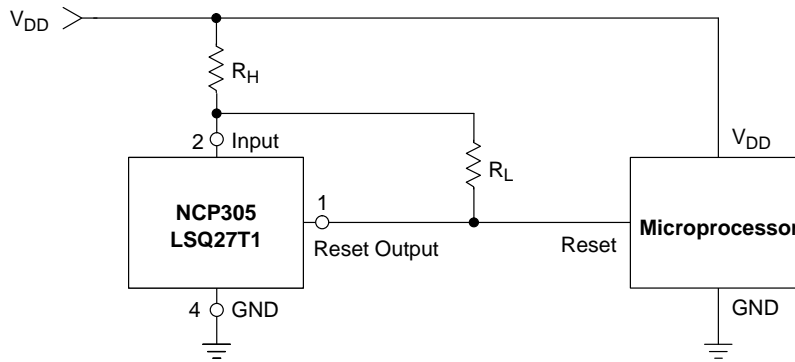

Figure 29. Microprocessor Reset Circuit with Additional Hysteresis

Comparator hysteresis can be increased with the addition of resistor R_H . The hysteresis equations have been simplified and do not account for the change of input current I_{in} as V_{in} crosses the comparator threshold. The internal resistance, R_{in} is simply calculated using $I_{in} = 0.26 \mu\text{A}$ at 2.6 V.

V_{in} Decreasing:

$$V_{th} = \left(\frac{R_H}{R_{in}} + 1 \right) (V_{DET-})$$

V_{in} Increasing:

$$V_{th} = \left(\frac{R_H}{R_{in} \parallel R_L} + 1 \right) (V_{DET-} + V_{HYS})$$

$$V_{HYS} = V_{in \text{ Increasing}} - V_{in \text{ Decreasing}}$$

| Test Data | | | | |
|--------------------------|--------------------------|----------------|--------------------|---------------------|
| V_{th} Decreasing (mV) | V_{th} Increasing (mV) | V_{HYS} (mV) | R_H (Ω) | R_L (k Ω) |
| 2.70 | 2.84 | 0.135 | 0 | – |
| 2.70 | 2.87 | 0.17 | 100 | 10 |
| 2.70 | 2.88 | 0.19 | 100 | 6.8 |
| 2.70 | 2.91 | 0.21 | 100 | 4.3 |
| 2.70 | 2.90 | 0.20 | 220 | 10 |
| 2.70 | 2.94 | 0.24 | 220 | 6.8 |
| 2.70 | 2.98 | 0.28 | 220 | 4.3 |
| 2.70 | 2.70 | 0.27 | 470 | 10 |
| 2.70 | 3.04 | 0.34 | 470 | 6.8 |
| 2.70 | 3.15 | 0.35 | 470 | 4.3 |

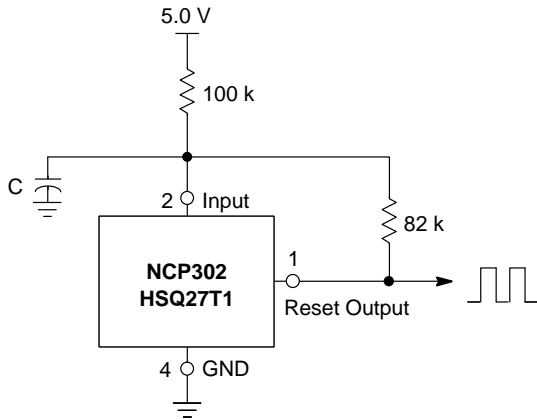

| Test Data | | |
|---------------------|-----------------|-------------------------|
| C (μF) | f_{OSC} (kHz) | I_Q (μA) |
| 0.01 | 2590 | 21.77 |
| 0.1 | 490 | 21.97 |
| 1.0 | 52 | 22.07 |

Figure 30. Simple Clock Oscillator

NCP304, NCP305



This circuit monitors the current at the load. As current flows through the load, a voltage drop with respect to ground appears across R_{sense} where $V_{sense} = I_{load} * R_{sense}$. The following conditions apply:

| | |
|--|-------------------------|
| If: | Then: |
| $I_{Load} < V_{DET-} / R_{sense}$ | Reset Output = 0 V |
| $I_{Load} \geq (V_{DET-} + V_{HYS}) / R_{sense}$ | Reset Output = V_{DD} |

Figure 31. Microcontroller Systems Load Sensing

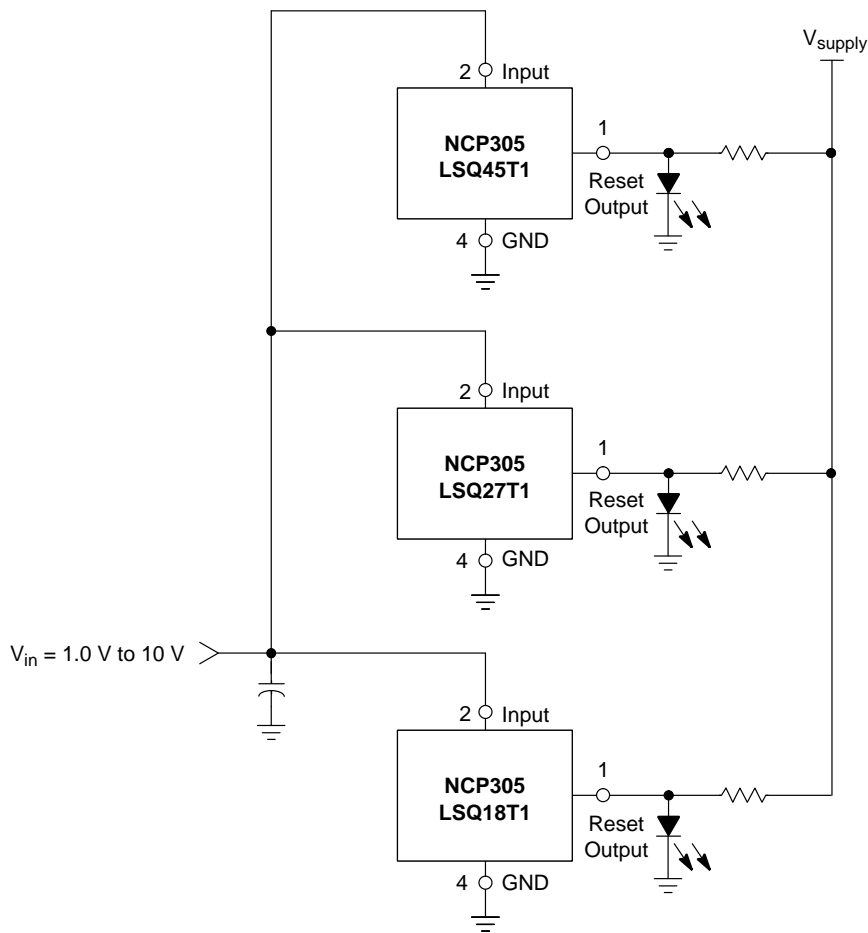

A simple voltage monitor can be constructed by connecting several voltage detectors as shown above. Each LED will sequentially turn on when the respective voltage detector threshold ($V_{DET-} + V_{HYS}$) is exceeded. Note that detector thresholds (V_{DET-}) that range from 0.9 V to 4.9 V in 100 mV steps can be manufactured.

Figure 32. LED Bar Graph

NCP304, NCP305

ORDERING INFORMATION

| Device | Threshold Voltage | Output Type | Reset | Marking | Package | Shipping [†] |
|-----------------|-------------------|-------------|-------------|---------|----------------------|-----------------------|
| NCP304LSQ09T1G | 0.9 | CMOS | Active Low | SHG | SC-82AB (Pb-Free) | 3000 / Tape & Reel |
| NCP304LSQ18T1G | 1.8 | | | SGX | | |
| NCP304LSQ20T1G | 2.0 | | | SGV | | |
| NCP304LSQ23T1G | 2.3 | | | SGR | | |
| NCP304LSQ25T1G | 2.5 | | | SGP | | |
| NCP304LSQ27T1G | 2.7 | | | SGN | | |
| NCP304LSQ280T1G | 2.8 | | | CAT | | |
| NCP304LSQ29T1G | 2.9 | | | SGK | | |
| NCP304LSQ30T1G | 3.0 | | | SGJ | | |
| NCV304LSQ30T1G* | 3.0 | | | ACT | | |
| NCP304LSQ33T1G | 3.3 | | | SGG | | |
| NCV304LSQ33T1G* | 3.3 | | | AGA | | |
| NCP304LSQ37T1G | 3.7 | | | SGB | | |
| NCP304LSQ38T1G | 3.8 | | | SGA | | |
| NCP304LSQ40T1G | 4.0 | | | SFY | | |
| NCP304LSQ42T1G | 4.2 | | | SFU | | |
| NCP304LSQ43T1G | 4.3 | | | SFV | | |
| NCP304LSQ45T1G | 4.5 | | | SFS | | |
| NCP304LSQ46T1G | 4.6 | | | SFR | | |
| NCP304LSQ47T1G | 4.7 | | | SFQ | | |
| NCP304HSQ09T1G | 0.9 | CMOS | Active High | SNQ | | |
| NCP304HSQ18T1G | 1.8 | | | SNZ | | |
| NCP304HSQ20T1G | 2.0 | | | SOB | | |
| NCP304HSQ22T1G | 2.2 | | | SOD | | |
| NCP304HSQ27T1G | 2.7 | | | SOI | | |
| NCP304HSQ29T1G | 2.9 | | | SOK | | |
| NCP304HSQ30T1G | 3.0 | | | SOL | | |
| NCP304HSQ45T1G | 4.5 | | | SPA | | |
| NCP304HSQ47T1G | 4.7 | | | SPC | | |

NOTE: The ordering information lists standard undervoltage thresholds with active low outputs. Additional active low threshold devices, ranging from 0.9 V to 4.9 V in 100 mV increments and NCP304 active high output devices, ranging from 0.9 V to 4.9 V in 100 mV increments can be manufactured. Contact your ON Semiconductor representative for availability. The electrical characteristics of these additional devices are shown in Tables 1 and 2.

[†]For information on tape and reel specifications, including part orientation and tape sizes, please refer to our Tape and Reel Packaging Specifications Brochure, BRD8011/D.

*NCV Prefix for Automotive and Other Applications Requiring Unique Site and Control Change Requirements; AEC-Q100 Qualified and PPAP Capable.

NCVxxx: T_{low} = -40°C, T_{high} = +125°C. Guaranteed by design.

NCP304, NCP305

ORDERING INFORMATION

| Device | Threshold Voltage | Output Type | Reset | Marking | Package | Shipping† |
|-----------------|-------------------|-------------|------------|---------|-------------------|----------------------|
| NCP305LSQ09T1G | 0.9 | Open Drain | Active Low | SIZ | SC-82AB (Pb-Free) | 3000 / Tape & Reel |
| NCP305LSQ11T1G | 1.1 | | | SIX | | |
| NCV305LSQ11T1G* | 1.1 | | | TAP | | |
| NCP305LSQ15T1G | 1.5 | | | SIS | | |
| NCP305LSQ16T1G | 1.6 | | | SIR | | |
| NCP305LSQ17T1G | 1.7 | | | SIQ | | |
| NCP305LSQ18T1G | 1.8 | | | SIP | | |
| NCP305LSQ20T1G | 2.0 | | | SIN | | |
| NCV305LSQ20T1G* | 2.0 | | | AAJ | | |
| NCP305LSQ22T1G | 2.2 | | | SIK | | |
| NCP305LSQ23T1G | 2.3 | | | SIJ | | |
| NCV305LSQ23T1G* | 2.3 | | | AUT | | |
| NCP305LSQ24T1G | 2.4 | | | SII | | |
| NCP305LSQ25T1G | 2.5 | | | SIH | | |
| NCP305LSQ26T1G | 2.6 | | | SIG | | |
| NCP305LSQ27T1G | 2.7 | | | SIF | | |
| NCP305LSQ28T1G | 2.8 | | | SIE | | |
| NCP305LSQ29T1G | 2.9 | | | SID | | |
| NCP305LSQ30T1G | 3.0 | | | SIC | | |
| NCP305LSQ30T3G | 3.0 | | | SIC | | 10,000 / Tape & Reel |
| NCP305LSQ31T1G | 3.1 | | | SIB | | 3000 / Tape & Reel |
| NCP305LSQ32T1G | 3.2 | | | SIA | | |
| NCP305LSQ33T1G | 3.3 | | | SHZ | | |
| NCP305LSQ34T1G | 3.4 | | | SHY | | |
| NCP305LSQ35T1G | 3.5 | | | SHX | | |
| NCP305LSQ36T1G | 3.6 | | | SHU | | |
| NCP305LSQ37T1G | 3.7 | | | SHV | | |
| NCP305LSQ40T1G | 4.0 | | | SHR | | |
| NCP305LSQ44T1G | 4.4 | | | SHN | | |
| NCV305LSQ44T1G* | 4.4 | | | AAH | | |
| NCP305LSQ45T1G | 4.5 | SHL | | | | |
| NCP305LSQ47T1G | 4.7 | SHJ | | | | |
| NCP305LSQ49T1G | 4.9 | SHH | | | | |

NOTE: The ordering information lists standard undervoltage thresholds with active low outputs. Additional active low threshold devices, ranging from 0.9 V to 4.9 V in 100 mV increments and NCP304 active high output devices, ranging from 0.9 V to 4.9 V in 100 mV increments can be manufactured. Contact your ON Semiconductor representative for availability. The electrical characteristics of these additional devices are shown in Tables 1 and 2.

†For information on tape and reel specifications, including part orientation and tape sizes, please refer to our Tape and Reel Packaging Specifications Brochure, BRD8011/D.

*NCV Prefix for Automotive and Other Applications Requiring Unique Site and Control Change Requirements; AEC-Q100 Qualified and PPAP Capable.

NCVxxx: $T_{low} = -40^{\circ}\text{C}$, $T_{high} = +125^{\circ}\text{C}$. Guaranteed by design.

NCP304, NCP305

PACKAGE DIMENSIONS

SC-82AB
SQ SUFFIX
 CASE 419C-02
 ISSUE F

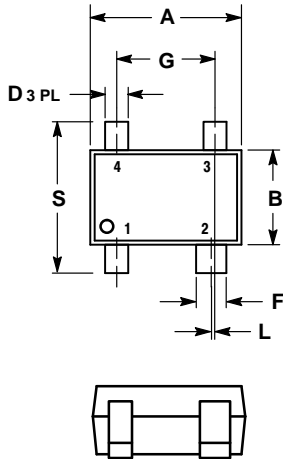

NOTES:

1. DIMENSIONING AND TOLERANCING PER ANSI Y14.5M, 1982.
2. CONTROLLING DIMENSION: MILLIMETER.
3. 419C-01 OBSOLETE. NEW STANDARD IS 419C-02.
4. DIMENSIONS A AND B DO NOT INCLUDE MOLD FLASH, PROTRUSIONS, OR GATE BURRS.

| DIM | MILLIMETERS | | INCHES | |
|-----|-------------|------|-----------|-------|
| | MIN | MAX | MIN | MAX |
| A | 1.80 | 2.20 | 0.071 | 0.087 |
| B | 1.15 | 1.35 | 0.045 | 0.053 |
| C | 0.80 | 1.10 | 0.031 | 0.043 |
| D | 0.20 | 0.40 | 0.008 | 0.016 |
| F | 0.30 | 0.50 | 0.012 | 0.020 |
| G | 1.10 | 1.50 | 0.043 | 0.059 |
| H | 0.00 | 0.10 | 0.000 | 0.004 |
| J | 0.10 | 0.26 | 0.004 | 0.010 |
| K | 0.10 | --- | 0.004 | --- |
| L | 0.05 BSC | | 0.002 BSC | |
| N | 0.20 REF | | 0.008 REF | |
| S | 1.80 | 2.40 | 0.07 | 0.09 |

SOLDERING FOOTPRINT*

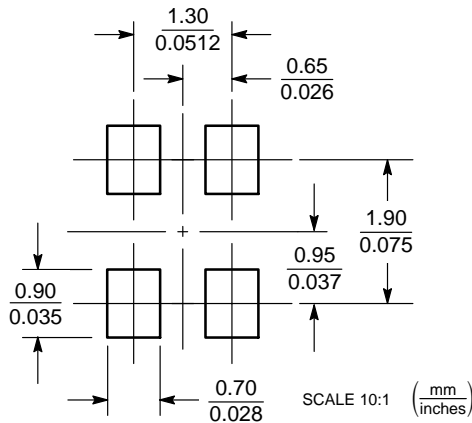

*For additional information on our Pb-Free strategy and soldering details, please download the ON Semiconductor Soldering and Mounting Techniques Reference Manual, SOLDERRM/D.

ON Semiconductor and the are registered trademarks of Semiconductor Components Industries, LLC (SCILLC) or its subsidiaries in the United States and/or other countries. SCILLC owns the rights to a number of patents, trademarks, copyrights, trade secrets, and other intellectual property. A listing of SCILLC's product/patent coverage may be accessed at www.onsemi.com/site/pdf/Patent-Marking.pdf. SCILLC reserves the right to make changes without further notice to any products herein. SCILLC makes no warranty, representation or guarantee regarding the suitability of its products for any particular purpose, nor does SCILLC assume any liability arising out of the application or use of any product or circuit, and specifically disclaims any and all liability, including without limitation special, consequential or incidental damages. "Typical" parameters which may be provided in SCILLC data sheets and/or specifications can and do vary in different applications and actual performance may vary over time. All operating parameters, including "Typicals" must be validated for each customer application by customer's technical experts. SCILLC does not convey any license under its patent rights nor the rights of others. SCILLC products are not designed, intended, or authorized for use as components in systems intended for surgical implant into the body, or other applications intended to support or sustain life, or for any other application in which the failure of the SCILLC product could create a situation where personal injury or death may occur. Should Buyer purchase or use SCILLC products for any such unintended or unauthorized application, Buyer shall indemnify and hold SCILLC and its officers, employees, subsidiaries, affiliates, and distributors harmless against all claims, costs, damages, and expenses, and reasonable attorney fees arising out of, directly or indirectly, any claim of personal injury or death associated with such unintended or unauthorized use, even if such claim alleges that SCILLC was negligent regarding the design or manufacture of the part. SCILLC is an Equal Opportunity/Affirmative Action Employer. This literature is subject to all applicable copyright laws and is not for resale in any manner.

PUBLICATION ORDERING INFORMATION

LITERATURE FULFILLMENT:

Literature Distribution Center for ON Semiconductor
 P.O. Box 5163, Denver, Colorado 80217 USA
Phone: 303-675-2175 or 800-344-3860 Toll Free USA/Canada
Fax: 303-675-2176 or 800-344-3867 Toll Free USA/Canada
Email: orderlit@onsemi.com

N. American Technical Support: 800-282-9855 Toll Free
 USA/Canada
Europe, Middle East and Africa Technical Support:
 Phone: 421 33 790 2910
Japan Customer Focus Center
 Phone: 81-3-5817-1050

ON Semiconductor Website: www.onsemi.com
Order Literature: <http://www.onsemi.com/orderlit>

For additional information, please contact your local Sales Representative

Looking for pricing, stock, or lifecycle information?

Click below to explore more details on WIN SOURCE:

- ⊖ [View NCP304LSQ29T1G on WIN SOURCE](#)
- ⊖ [ON Semiconductor Information](#)

Optimize Your Supply Chain with WIN SOURCE Solutions

- ✓ Global Sourcing Solution
- ✓ Obsolete Management
- ✓ Cost Control Management
- ✓ Shortage Management
- ✓ Alternative Solution
- ✓ Excess Inventory Management