



**THE DATASHEET OF  
NCP304HSQ27T1G**



# NCP304, NCP305

## Voltage Detector Series

The NCP304 and NCP305 series are second generation ultra-low current voltage detectors. These devices are specifically designed for use as reset controllers in portable microprocessor based systems where extended battery life is paramount.

Each series features a highly accurate undervoltage detector with hysteresis which prevents erratic system reset operation as the comparator threshold is crossed.

The NCP304 series consists of complementary output devices that are available with either an active high or active low reset output. The NCP305 series has an open drain N-Channel output with an active low reset output.

The NCP304 and NCP305 device series are available in the SC-82AB package with standard undervoltage thresholds. Additional thresholds that range from 0.9 V to 4.9 V in 100 mV steps can be manufactured.

### Features

- Quiescent Current of 1.0  $\mu$ A Typical
- High Accuracy Undervoltage Threshold of 2.0%
- Wide Operating Voltage Range of 0.8 V to 10 V
- Complementary or Open Drain Reset Output
- Active Low or Active High Reset Output
- NCV Prefix for Automotive and Other Applications Requiring Unique Site and Control Change Requirements; AEC-Q100 Qualified and PPAP Capable
- These Devices are Pb-Free and are RoHS Compliant

### Typical Applications

- Microprocessor Reset Controller
- Low Battery Detection
- Power Fail Indicator
- Battery Backup Detection



This device contains 38 active transistors.

\* The representative block diagram depicts active low reset output 'L' suffix devices. The comparator input is interchanged for the active high output 'H' suffix devices.



This device contains 37 active transistors.

Figure 1. Representative Block Diagrams



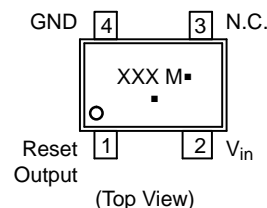
ON Semiconductor®

[www.onsemi.com](http://www.onsemi.com)



SC-82AB  
SQ SUFFIX  
CASE 419C

### PIN CONNECTIONS AND MARKING DIAGRAM



XXX = Specific Device Code  
M = Date Code  
▪ = Pb-Free Package

(Note: Microdot may be in either location)

### ORDERING INFORMATION

See detailed ordering, marking and shipping information in the ordering information section on page 19 of this data sheet.

# NCP304, NCP305

## MAXIMUM RATINGS (Note 1)

Rating	Symbol	Value	Unit
Input Power Supply Voltage (Pin 2)	$V_{in}$	12	V
Output Voltage (Pin 1) Complementary, NCP304 N-Channel Open Drain, NCP305	$V_{OUT}$	-0.3 to $V_{in}+0.3$ -0.3 to 12	V
Output Current (Pin 1) (Note 2)	$I_{OUT}$	70	mA
Thermal Resistance, Junction-to-Air	$R_{\theta JA}$	285	°C/W
Maximum Junction Temperature	$T_J$	+125	°C
Storage Temperature Range	$T_{stg}$	-55 to +150	°C
Latchup Performance (Note 3) Positive Negative	$I_{LATCHUP}$	500 170	mA

Stresses exceeding those listed in the Maximum Ratings table may damage the device. If any of these limits are exceeded, device functionality should not be assumed, damage may occur and reliability may be affected.

- This device series contains ESD protection and exceeds the following tests:  
Human Body Model 2000 V per MIL-STD-883, Method 3015.  
Machine Model Method 200 V.
- The maximum package power dissipation limit must not be exceeded.

$$P_D = \frac{T_{J(max)} - T_A}{R_{\theta JA}}$$

- Maximum Ratings per JEDEC standard JESD78.

## ELECTRICAL CHARACTERISTICS (For all values $T_A = 25^\circ\text{C}$ , unless otherwise noted.)

Characteristic	Symbol	Min	Typ	Max	Unit
<b>NCP304/5 – 0.9</b>					
Detector Threshold (Pin 2, $V_{in}$ Decreasing)	$V_{DET-}$	0.882	0.900	0.918	V
Detector Threshold Hysteresis (Pin 2, $V_{in}$ Increasing)	$V_{HYS}$	0.027	0.045	0.063	V
Supply Current (Pin 2) ( $V_{in} = 0.8\text{ V}$ ) ( $V_{in} = 2.9\text{ V}$ )	$I_{in}$	- -	0.8 -	2.4 3.0	$\mu\text{A}$
Maximum Operating Voltage (Pin 2)	$V_{in(max)}$	-	-	10	V
Minimum Operating Voltage (Pin 2) ( $T_A = -40^\circ\text{C}$ to $85^\circ\text{C}$ )	$V_{in(min)}$	- -	0.55 0.65	0.70 0.80	V
Reset Output Current (Pin 1, Active Low 'L' Suffix Devices)  N-Channel Sink Current, NCP304, NCP305 ( $V_{OUT} = 0.05\text{ V}$ , $V_{in} = 0.70\text{ V}$ ) ( $V_{OUT} = 0.50\text{ V}$ , $V_{in} = 0.85\text{ V}$ )  P-Channel Source Current, NCP304 ( $V_{OUT} = 2.4\text{ V}$ , $V_{in} = 4.5\text{ V}$ )	$I_{OUT}$	0.01 0.05  1.0	0.05 0.50  2.0	- -  -	mA
Reset Output Current (Pin 1, Active High 'H' Suffix Devices)  N-Channel Sink Current, NCP304, NCP305 ( $V_{OUT} = 0.5\text{ V}$ , $V_{in} = 1.5\text{ V}$ )  P-Channel Source Current, NCP304 ( $V_{OUT} = 0.4\text{ V}$ , $V_{in} = 0.7\text{ V}$ ) ( $V_{OUT} = \text{GND}$ , $V_{in} = 0.8\text{ V}$ )	$I_{OUT}$	1.05  0.011 0.014	2.5  0.04 0.08	-  - -	mA
Propagation Delay Input to Output (Figure 2)					$\mu\text{s}$

- In the case of CMOS Output Type: The time interval between the rising edge of  $V_{DD}$  input pulse from 0.7 V to  $(+V_{DET}) + 2.0\text{ V}$  and output voltage level becoming to  $V_{DD}/2$ . In the case of N-Channel Open Drain Output Type: Output pin is pulled up with a resistance of 470 k $\Omega$  to 5.0 V, the time interval between the rising edge of  $V_{DD}$  input pulse from 0.7 V to  $(+V_{DET}) + 2.0\text{ V}$  and output voltage level becoming to 2.5 V.

# NCP304, NCP305

## ELECTRICAL CHARACTERISTICS (continued) (For all values $T_A = 25^\circ\text{C}$ , unless otherwise noted.)

Characteristic	Symbol	Min	Typ	Max	Unit
<b>NCP304/5 – 0.9</b>					
Complementary Output NCP304 Series Output Transition, High to Low (Note 4)	$t_{pHL}$	–	18	–	
Output Transition, Low to High (Note 4)	$t_{pLH}$	–	6.0	60	
N-Channel Open Drain NCP305 Series Output Transition, High to Low (Note 4)	$t_{pHL}$	–	18	–	
Output Transition, Low to High (Note 4)	$t_{pLH}$	–	–	100	
<b>NCP304/5 – 1.8</b>					
Detector Threshold (Pin 2, $V_{in}$ Decreasing)	$V_{DET-}$	1.764	1.80	1.836	V
Detector Threshold Hysteresis (Pin 2, $V_{in}$ Increasing)	$V_{HYS}$	0.054	0.090	0.126	V
Supply Current (Pin 2) ( $V_{in} = 1.7\text{ V}$ ) ( $V_{in} = 3.8\text{ V}$ )	$I_{in}$	– –	0.8 1.0	2.4 3.0	$\mu\text{A}$
Maximum Operating Voltage (Pin 2)	$V_{in(max)}$	–	–	10	V
Minimum Operating Voltage (Pin 2) ( $T_A = -40^\circ\text{C}$ to $85^\circ\text{C}$ )	$V_{in(min)}$	– –	0.55 0.65	0.70 0.80	V
Reset Output Current (Pin 1, Active Low 'L' Suffix Devices)  N-Channel Sink Current, NCP304, NCP305 ( $V_{OUT} = 0.05\text{ V}$ , $V_{in} = 0.70\text{ V}$ ) ( $V_{OUT} = 0.50\text{ V}$ , $V_{in} = 1.5\text{ V}$ )  P-Channel Source Current, NCP304 ( $V_{OUT} = 2.4\text{ V}$ , $V_{in} = 4.5\text{ V}$ )	$I_{OUT}$	 0.01 1.0  1.0	 0.05 2.0  2.0	 – –  –	mA
Reset Output Current (Pin 1, Active High 'H' Suffix Devices)  N-Channel Sink Current, NCP304, NCP305 ( $V_{OUT} = 0.5\text{ V}$ , $V_{in} = 5.0\text{ V}$ )  P-Channel Source Current, NCP304 ( $V_{OUT} = 0.4\text{ V}$ , $V_{in} = 0.7\text{ V}$ ) ( $V_{OUT} = \text{GND}$ , $V_{in} = 1.5\text{ V}$ )	$I_{OUT}$	 6.3  0.011 0.525	 11  0.04 0.6	 –  – –	mA
Propagation Delay Input to Output (Figure 2)  Complementary Output NCP304 Series Output Transition, High to Low (Note 4) Output Transition, Low to High (Note 4)  N-Channel Open Drain NCP305 Series Output Transition, High to Low (Note 4) Output Transition, Low to High (Note 4)	$t_{pHL}$ $t_{pLH}$  $t_{pHL}$ $t_{pLH}$	 – –  – –	 14 15  14 –	 – 60  – 100	$\mu\text{s}$
<b>NCP304/5 – 2.0</b>					
Detector Threshold (Pin 2, $V_{in}$ Decreasing)	$V_{DET-}$	1.960	2.00	2.040	V
Detector Threshold Hysteresis (Pin 2, $V_{in}$ Increasing)	$V_{HYS}$	0.06	0.10	0.14	V
Supply Current (Pin 2) ( $V_{in} = 1.9\text{ V}$ ) ( $V_{in} = 4.0\text{ V}$ )	$I_{in}$	– –	0.9 1.1	2.7 3.3	$\mu\text{A}$
Maximum Operating Voltage (Pin 2)	$V_{in(max)}$	–	–	10	V
Minimum Operating Voltage (Pin 2) ( $T_A = -40^\circ\text{C}$ to $85^\circ\text{C}$ )	$V_{in(min)}$	– –	0.55 0.65	0.70 0.80	V
Reset Output Current (Pin 1, Active Low 'L' Suffix Devices)	$I_{OUT}$				mA

4. In the case of CMOS Output Type: The time interval between the rising edge of  $V_{DD}$  input pulse from 0.7 V to  $(+V_{DET}) + 2.0\text{ V}$  and output voltage level becoming to  $V_{DD}/2$ . In the case of N-Channel Open Drain Output Type: Output pin is pulled up with a resistance of 470 k $\Omega$  to 5.0 V, the time interval between the rising edge of  $V_{DD}$  input pulse from 0.7 V to  $(+V_{DET}) + 2.0\text{ V}$  and output voltage level becoming to 2.5 V.

# NCP304, NCP305

## ELECTRICAL CHARACTERISTICS (continued) (For all values $T_A = 25^\circ\text{C}$ , unless otherwise noted.)

Characteristic	Symbol	Min	Typ	Max	Unit
<b>NCP304/5 – 2.0</b>					
N-Channel Sink Current, NCP304, NCP305 ( $V_{OUT} = 0.05\text{ V}$ , $V_{in} = 0.70\text{ V}$ ) ( $V_{OUT} = 0.50\text{ V}$ , $V_{in} = 1.5\text{ V}$ )		0.01 1.0	0.05 2.0	– –	
P-Channel Source Current, NCP304 ( $V_{OUT} = 2.4\text{ V}$ , $V_{in} = 4.5\text{ V}$ )		1.0	2.0	–	
Reset Output Current (Pin 1, Active High 'H' Suffix Devices)	$I_{OUT}$				mA
N-Channel Sink Current, NCP304, NCP305 ( $V_{OUT} = 0.5\text{ V}$ , $V_{in} = 5.0\text{ V}$ )		6.3	11	–	
P-Channel Source Current, NCP304 ( $V_{OUT} = 0.4\text{ V}$ , $V_{in} = 0.7\text{ V}$ ) ( $V_{OUT} = \text{GND}$ , $V_{in} = 1.5\text{ V}$ )		0.011 0.525	0.04 0.6	– –	
Propagation Delay Input to Output (Figure 2)					$\mu\text{s}$
Complementary Output NCP304 Series Output Transition, High to Low (Note 4) Output Transition, Low to High (Note 4)	$t_{pHL}$ $t_{pLH}$	– –	13 15	– 60	
N-Channel Open Drain NCP305 Series Output Transition, High to Low (Note 4) Output Transition, Low to High (Note 4)	$t_{pHL}$ $t_{pLH}$	– –	13 –	– 100	
<b>NCP304/5 – 2.7</b>					
Detector Threshold (Pin 2, $V_{in}$ Decreasing)	$V_{DET-}$	2.646	2.700	2.754	V
Detector Threshold Hysteresis (Pin 2, $V_{in}$ Increasing)	$V_{HYS}$	0.081	0.135	0.189	V
Supply Current (Pin 2) ( $V_{in} = 2.6\text{ V}$ ) ( $V_{in} = 4.7\text{ V}$ )	$I_{in}$	– –	0.9 1.1	2.7 3.3	$\mu\text{A}$
Maximum Operating Voltage (Pin 2)	$V_{in(max)}$	–	–	10	V
Minimum Operating Voltage (Pin 2) ( $T_A = -40^\circ\text{C}$ to $85^\circ\text{C}$ )	$V_{in(min)}$	– –	0.55 0.65	0.70 0.80	V
Reset Output Current (Pin 1, Active Low 'L' Suffix Devices)	$I_{OUT}$				mA
N-Channel Sink Current, NCP304, NCP305 ( $V_{OUT} = 0.05\text{ V}$ , $V_{in} = 0.70\text{ V}$ ) ( $V_{OUT} = 0.50\text{ V}$ , $V_{in} = 1.5\text{ V}$ )		0.01 1.0	0.05 2.0	– –	
P-Channel Source Current, NCP304 ( $V_{OUT} = 2.4\text{ V}$ , $V_{in} = 4.5\text{ V}$ )		1.0	2.0	–	
Reset Output Current (Pin 1, Active High 'H' Suffix Devices)	$I_{OUT}$				mA
N-Channel Sink Current, NCP304, NCP305 ( $V_{OUT} = 0.5\text{ V}$ , $V_{in} = 5.0\text{ V}$ )		6.3	11	–	
P-Channel Source Current, NCP304 ( $V_{OUT} = 0.4\text{ V}$ , $V_{in} = 0.7\text{ V}$ ) ( $V_{OUT} = \text{GND}$ , $V_{in} = 1.5\text{ V}$ )		0.011 0.525	0.04 0.6	– –	
Propagation Delay Input to Output (Figure 2)					$\mu\text{s}$
Complementary Output NCP304 Series Output Transition, High to Low (Note 4) Output Transition, Low to High (Note 4)	$t_{pHL}$ $t_{pLH}$	– –	12 19	– 60	
N-Channel Open Drain NCP305 Series Output Transition, High to Low (Note 4) Output Transition, Low to High (Note 4)	$t_{pHL}$ $t_{pLH}$	– –	12 –	– 100	

4. In the case of CMOS Output Type: The time interval between the rising edge of  $V_{DD}$  input pulse from 0.7 V to  $(+V_{DET}) + 2.0\text{ V}$  and output voltage level becoming to  $V_{DD}/2$ . In the case of N-Channel Open Drain Output Type: Output pin is pulled up with a resistance of 470 k $\Omega$  to 5.0 V, the time interval between the rising edge of  $V_{DD}$  input pulse from 0.7 V to  $(+V_{DET}) + 2.0\text{ V}$  and output voltage level becoming to 2.5 V.

# NCP304, NCP305

**ELECTRICAL CHARACTERISTICS (continued)** (For all values  $T_A = 25^\circ\text{C}$ , unless otherwise noted.)

Characteristic	Symbol	Min	Typ	Max	Unit
<b>NCP304/5 – 2.9</b>					
Detector Threshold (Pin 2, $V_{in}$ Decreasing)	$V_{DET-}$	2.842	2.900	2.958	V
Detector Threshold Hysteresis (Pin 2, $V_{in}$ Increasing)	$V_{HYS}$	0.087	0.145	0.203	V
Supply Current (Pin 2) ( $V_{in} = 2.8\text{ V}$ ) ( $V_{in} = 4.9\text{ V}$ )	$I_{in}$	– –	0.9 1.1	2.9 3.5	$\mu\text{A}$
Maximum Operating Voltage (Pin 2)	$V_{in(max)}$	–	–	10	V
Minimum Operating Voltage (Pin 2) ( $T_A = -40^\circ\text{C}$ to $85^\circ\text{C}$ )	$V_{in(min)}$	– –	0.55 0.65	0.70 0.80	V
Reset Output Current (Pin 1, Active Low 'L' Suffix Devices)  N-Channel Sink Current, NCP304, NCP305 ( $V_{OUT} = 0.05\text{ V}$ , $V_{in} = 0.70\text{ V}$ ) ( $V_{OUT} = 0.50\text{ V}$ , $V_{in} = 1.5\text{ V}$ )  P-Channel Source Current, NCP304 ( $V_{OUT} = 2.4\text{ V}$ , $V_{in} = 4.5\text{ V}$ )	$I_{OUT}$	0.01 1.0	0.05 2.0	– –	mA
Reset Output Current (Pin 1, Active High 'H' Suffix Devices)  N-Channel Sink Current, NCP304, NCP305 ( $V_{OUT} = 0.5\text{ V}$ , $V_{in} = 5.0\text{ V}$ )  P-Channel Source Current, NCP304 ( $V_{OUT} = 0.4\text{ V}$ , $V_{in} = 0.7\text{ V}$ ) ( $V_{OUT} = \text{GND}$ , $V_{in} = 1.5\text{ V}$ )	$I_{OUT}$	6.3 0.011 0.525	11 0.04 0.6	– – –	mA
Propagation Delay Input to Output (Figure 2)  Complementary Output NCP304 Series Output Transition, High to Low (Note 4) Output Transition, Low to High (Note 4)  N-Channel Open Drain NCP305 Series Output Transition, High to Low (Note 4) Output Transition, Low to High (Note 4)	$t_{pHL}$ $t_{pLH}$  $t_{pHL}$ $t_{pLH}$	– –  – –	12 19  12 –	– 60  – 100	$\mu\text{s}$
<b>NCP304/5 – 3.0</b>					
Detector Threshold (Pin 2, $V_{in}$ Decreasing)	$V_{DET-}$	2.94	3.00	3.06	V
Detector Threshold Hysteresis (Pin 2, $V_{in}$ Increasing)	$V_{HYS}$	0.09	0.15	0.21	V
Supply Current (Pin 2) ( $V_{in} = 2.87\text{ V}$ ) ( $V_{in} = 5.0\text{ V}$ )	$I_{in}$	– –	1.0 1.2	3.0 3.6	$\mu\text{A}$
Maximum Operating Voltage (Pin 2)	$V_{in(max)}$	–	–	10	V
Minimum Operating Voltage (Pin 2) ( $T_A = -40^\circ\text{C}$ to $85^\circ\text{C}$ )	$V_{in(min)}$	– –	0.55 0.65	0.70 0.80	V
Reset Output Current (Pin 1, Active Low 'L' Suffix Devices)  N-Channel Sink Current, NCP304, NCP305 ( $V_{OUT} = 0.05\text{ V}$ , $V_{in} = 0.70\text{ V}$ ) ( $V_{OUT} = 0.50\text{ V}$ , $V_{in} = 1.5\text{ V}$ )  P-Channel Source Current, NCP304 ( $V_{OUT} = 2.4\text{ V}$ , $V_{in} = 4.5\text{ V}$ )	$I_{OUT}$	0.01 1.0	0.05 2.0	– –	mA
Reset Output Current (Pin 1, Active High 'H' Suffix Devices)  N-Channel Sink Current, NCP304, NCP305 ( $V_{OUT} = 0.5\text{ V}$ , $V_{in} = 5.0\text{ V}$ )	$I_{OUT}$	6.3	11	–	mA

4. In the case of CMOS Output Type: The time interval between the rising edge of  $V_{DD}$  input pulse from 0.7 V to  $(+V_{DET}) + 2.0\text{ V}$  and output voltage level becoming to  $V_{DD}/2$ . In the case of N-Channel Open Drain Output Type: Output pin is pulled up with a resistance of 470 k $\Omega$  to 5.0 V, the time interval between the rising edge of  $V_{DD}$  input pulse from 0.7 V to  $(+V_{DET}) + 2.0\text{ V}$  and output voltage level becoming to 2.5 V.

# NCP304, NCP305

## ELECTRICAL CHARACTERISTICS (continued) (For all values $T_A = 25^\circ\text{C}$ , unless otherwise noted.)

Characteristic	Symbol	Min	Typ	Max	Unit
<b>NCP304/5 – 3.0</b>					
P-Channel Source Current, NCP304 ( $V_{OUT} = 0.4\text{ V}$ , $V_{in} = 0.7\text{ V}$ ) ( $V_{OUT} = \text{GND}$ , $V_{in} = 1.5\text{ V}$ )		0.011 0.525	0.04 0.6	– –	
Propagation Delay Input to Output (Figure 2)					$\mu\text{s}$
Complementary Output NCP304 Series Output Transition, High to Low (Note 4) Output Transition, Low to High (Note 4)	$t_{pHL}$ $t_{pLH}$	– –	12 19	– 60	
N-Channel Open Drain NCP305 Series Output Transition, High to Low (Note 4) Output Transition, Low to High (Note 4)	$t_{pHL}$ $t_{pLH}$	– –	12 –	– 100	

### NCP304/5 – 4.5

Detector Threshold (Pin 2, $V_{in}$ Decreasing)	$V_{DET-}$	4.410	4.500	4.590	V
Detector Threshold Hysteresis (Pin 2, $V_{in}$ Increasing)	$V_{HYS}$	0.135	0.225	0.315	V
Supply Current (Pin 2) ( $V_{in} = 4.34\text{ V}$ ) ( $V_{in} = 6.5\text{ V}$ )	$I_{in}$	– –	– –	3.0 3.9	$\mu\text{A}$
Maximum Operating Voltage (Pin 2)	$V_{in(max)}$	–	–	10	V
Minimum Operating Voltage (Pin 2) ( $T_A = -40^\circ\text{C}$ to $85^\circ\text{C}$ )	$V_{in(min)}$	– –	0.55 0.65	0.70 0.80	V
Reset Output Current (Pin 1, Active Low 'L' Suffix Devices)  N-Channel Sink Current, NCP304, NCP305 ( $V_{OUT} = 0.05\text{ V}$ , $V_{in} = 0.70\text{ V}$ ) ( $V_{OUT} = 0.50\text{ V}$ , $V_{in} = 1.5\text{ V}$ )  P-Channel Source Current, NCP304 ( $V_{OUT} = 5.9\text{ V}$ , $V_{in} = 8.0\text{ V}$ )	$I_{OUT}$	0.01 1.0 1.5	0.05 2.0 3.0	– – –	mA
Reset Output Current (Pin 1, Active High 'H' Suffix Devices)  N-Channel Sink Current, NCP304, NCP305 ( $V_{OUT} = 0.5\text{ V}$ , $V_{in} = 5.0\text{ V}$ )  P-Channel Source Current, NCP304 ( $V_{OUT} = 0.4\text{ V}$ , $V_{in} = 0.7\text{ V}$ ) ( $V_{OUT} = \text{GND}$ , $V_{in} = 1.5\text{ V}$ )	$I_{OUT}$	6.3 0.011 0.525	11 0.04 0.6	– – –	mA
Propagation Delay Input to Output (Figure 2)					$\mu\text{s}$
Complementary Output NCP304 Series Output Transition, High to Low (Note 4) Output Transition, Low to High (Note 4)	$t_{pHL}$ $t_{pLH}$	– –	10 21	– 60	
N-Channel Open Drain NCP305 Series Output Transition, High to Low (Note 4) Output Transition, Low to High (Note 4)	$t_{pHL}$ $t_{pLH}$	– –	10 –	– 100	

### NCP304/5 – 4.7

Detector Threshold (Pin 2, $V_{in}$ Decreasing)	$V_{DET-}$	4.606	4.70	4.794	V
Detector Threshold Hysteresis (Pin 2, $V_{in}$ Increasing)	$V_{HYS}$	0.141	0.235	0.329	V
Supply Current (Pin 2) ( $V_{in} = 4.54\text{ V}$ ) ( $V_{in} = 6.7\text{ V}$ )	$I_{in}$	– –	1.1 1.3	3.0 3.9	$\mu\text{A}$
Maximum Operating Voltage (Pin 2)	$V_{in(max)}$	–	–	10	V

4. In the case of CMOS Output Type: The time interval between the rising edge of  $V_{DD}$  input pulse from 0.7 V to  $(+V_{DET}) + 2.0\text{ V}$  and output voltage level becoming to  $V_{DD}/2$ . In the case of N-Channel Open Drain Output Type: Output pin is pulled up with a resistance of 470 k $\Omega$  to 5.0 V, the time interval between the rising edge of  $V_{DD}$  input pulse from 0.7 V to  $(+V_{DET}) + 2.0\text{ V}$  and output voltage level becoming to 2.5 V.

# NCP304, NCP305

## ELECTRICAL CHARACTERISTICS (continued) (For all values $T_A = 25^\circ\text{C}$ , unless otherwise noted.)

Characteristic	Symbol	Min	Typ	Max	Unit
<b>NCP304/5 – 4.7</b>					
Minimum Operating Voltage (Pin 2) ( $T_A = -40^\circ\text{C}$ to $85^\circ\text{C}$ )	$V_{in(min)}$	– –	0.55 0.65	0.70 0.80	V
Reset Output Current (Pin 1, Active Low ‘L’ Suffix Devices)  N–Channel Sink Current, NCP304, NCP305 ( $V_{OUT} = 0.05\text{ V}$ , $V_{in} = 0.70\text{ V}$ ) ( $V_{OUT} = 0.50\text{ V}$ , $V_{in} = 1.5\text{ V}$ )  P–Channel Source Current, NCP304 ( $V_{OUT} = 5.9\text{ V}$ , $V_{in} = 8.0\text{ V}$ )	$I_{OUT}$	0.01 1.0 1.5	0.05 2.0 3.0	– – –	mA
Reset Output Current (Pin 1, Active High ‘H’ Suffix Devices)  N–Channel Sink Current, NCP304, NCP305 ( $V_{OUT} = 0.5\text{ V}$ , $V_{in} = 5.0\text{ V}$ )  P–Channel Source Current, NCP304 ( $V_{OUT} = 0.4\text{ V}$ , $V_{in} = 0.7\text{ V}$ ) ( $V_{OUT} = \text{GND}$ , $V_{in} = 1.5\text{ V}$ )	$I_{OUT}$	6.3 0.011 0.525	11 0.04 0.6	– – –	mA
Propagation Delay Input to Output (Figure 2)  Complementary Output NCP304 Series Output Transition, High to Low (Note 4) Output Transition, Low to High (Note 4)  N–Channel Open Drain NCP305 Series Output Transition, High to Low (Note 4) Output Transition, Low to High (Note 4)	$t_{pHL}$ $t_{pLH}$  $t_{pHL}$ $t_{pLH}$	– – – –	10 21 10 –	– 60 – 100	$\mu\text{s}$

4. In the case of CMOS Output Type: The time interval between the rising edge of  $V_{DD}$  input pulse from 0.7 V to  $(+V_{DET}) + 2.0\text{ V}$  and output voltage level becoming to  $V_{DD}/2$ . In the case of N–Channel Open Drain Output Type: Output pin is pulled up with a resistance of 470 k $\Omega$  to 5.0 V, the time interval between the rising edge of  $V_{DD}$  input pulse from 0.7 V to  $(+V_{DET}) + 2.0\text{ V}$  and output voltage level becoming to 2.5 V.

## NCP304, NCP305



NCP304 and NCP305 series are measured with a 10 pF capacitive load. NCP305 has an additional 470 k pullup resistor connected from the reset output to +5.0 V. The reset output voltage waveforms are shown for the active low 'L' devices. The upper detector threshold,  $V_{DET+}$  is the sum of the lower detector threshold,  $V_{DET-}$  plus the input hysteresis,  $V_{HYS}$ .

**Figure 2. Propagation Delay Measurement Conditions**

# NCP304, NCP305

**Table 1. NCP304 SERIES ELECTRICAL CHARACTERISTIC TABLE FOR 0.9 – 4.9 V**

Part Number	Detector Threshold			Detector Threshold Hysteresis			Supply Current		N-Chl Sink Current		P-Channel Source Current
							V <sub>in</sub> Low	V <sub>in</sub> High	V <sub>in</sub> Low	V <sub>in</sub> High	
	V <sub>DET-</sub> (V)			V <sub>HYS</sub> (V)			I <sub>in</sub> (μA) (Note 5)	I <sub>in</sub> (μA) (Note 6)	I <sub>OUT</sub> (mA) (Note 7)	I <sub>OUT</sub> (mA) (Note 8)	I <sub>OUT</sub> (mA) (Note 9)
	Min	Typ	Max	Min	Typ	Max	Typ	Typ	Typ	Typ	Typ
NCP304LSQ09T1	0.882	0.9	0.918	0.027	0.045	0.063	0.8	0.9	0.05	0.5	2.0
NCP304LSQ15T1	1.470	1.5	1.530	0.045	0.075	0.105	0.9	1.1	0.05	0.5	2.0
NCP304LSQ18T1	1.764	1.8	1.836	0.054	0.090	0.126					
NCP304LSQ20T1	1.960	2.0	2.040	0.060	0.100	0.140					
NCP304LSQ23T1	2.254	2.3	2.346	0.069	0.115	0.161					
NCP304LSQ25T1	2.450	2.5	2.550	0.075	0.125	0.175					
NCP304LSQ27T1	2.646	2.7	2.754	0.081	0.135	0.189					
NCP304LSQ28T1	2.744	2.8	2.856	0.084	0.140	0.196					
NCP304LSQ29T1	2.842	2.9	2.958	0.087	0.145	0.203	1.0	1.2	0.05	0.5	2.0
NCP304LSQ30T1	2.940	3.0	3.060	0.090	0.150	0.210					
NCP304LSQ31T1	3.038	3.1	3.162	0.093	0.155	0.217					
NCP304LSQ33T1	3.234	3.3	3.366	0.099	0.165	0.231					
NCP304LSQ37T1	3.626	3.7	3.774	0.111	0.185	0.259					
NCP304LSQ38T1	3.724	3.8	3.876	0.114	0.190	0.266	1.1	1.3	0.05	0.5	2.0
NCP304LSQ40T1	3.920	4.0	4.080	0.120	0.200	0.280					
NCP304LSQ42T1	4.116	4.2	4.284	0.126	0.210	0.294					
NCP304LSQ43T1	4.214	4.3	4.386	0.129	0.215	0.301					
NCP304LSQ45T1	4.410	4.5	4.590	0.135	0.225	0.315					
NCP304LSQ46T1	4.508	4.6	4.692	0.138	0.230	0.322					
NCP304LSQ47T1	4.606	4.7	4.794	0.141	0.235	0.329					

5. Condition 1: 0.9 – 2.9 V, V<sub>in</sub> = V<sub>DET-</sub> – 0.10 V; 3.0 – 3.9 V, V<sub>in</sub> = V<sub>DET-</sub> – 0.13 V; 4.0 – 4.9 V, V<sub>in</sub> = V<sub>DET-</sub> – 0.16 V  
 6. Condition 2: 0.9 – 4.9 V, V<sub>in</sub> = V<sub>DET-</sub> + 2.0 V  
 7. Condition 3: 0.9 – 4.9 V, V<sub>in</sub> = 0.7 V, V<sub>OUT</sub> = 0.05 V, Active Low 'L' Suffix Devices  
 8. Condition 4: 0.9 – 1.0 V, V<sub>in</sub> = 0.85 V, V<sub>OUT</sub> = 0.5 V; 1.1 – 1.5 V, V<sub>in</sub> = 1.0 V, V<sub>OUT</sub> = 0.5 V; 1.6 – 4.9 V, V<sub>in</sub> = 1.5 V, V<sub>OUT</sub> = 0.5 V, Active Low 'L' Suffix Devices  
 9. Condition 5: 0.9 – 3.9 V, V<sub>in</sub> = 4.5 V, V<sub>OUT</sub> = 2.4 V; 4.0 – 4.9 V, V<sub>in</sub> = 8.0 V, V<sub>OUT</sub> = 5.9 V, Active Low 'L' Suffix Devices

**Table 2. NCP304 SERIES ELECTRICAL CHARACTERISTIC TABLE FOR 0.9 – 4.9 V**

Part Number	Detector Threshold			Detector Threshold Hysteresis			Supply Current		N-Channel Sink Current	P-Channel Source Current	
							V <sub>in</sub> Low	V <sub>in</sub> High		V <sub>in</sub> Low	V <sub>in</sub> High
	V <sub>DET-</sub> (V)			V <sub>HYS</sub> (V)			I <sub>in</sub> (μA) (Note 10)	I <sub>in</sub> (μA) (Note 11)	I <sub>OUT</sub> (mA) (Note 12)	I <sub>OUT</sub> (mA) (Note 13)	I <sub>OUT</sub> (mA) (Note 14)
	Min	Typ	Max	Min	Typ	Max	Typ	Typ	Typ	Typ	Typ
NCP304HSQ09T1	0.882	0.9	0.918	0.027	0.045	0.063	0.8	0.9	2.5	0.04	0.08
NCP304HSQ18T1	1.764	1.8	1.836	0.054	0.090	0.126	0.9	1.1	2.5	0.04	0.08
NCP304HSQ20T1	1.960	2.0	2.040	0.060	0.100	0.140					
NCP304HSQ22T1	2.156	2.2	2.244	0.066	0.110	0.154					
NCP304HSQ27T1	2.646	2.7	2.754	0.081	0.135	0.189					
NCP304HSQ29T1	2.842	2.9	2.958	0.087	0.145	0.203					
NCP304HSQ30T1	2.940	3.0	3.060	0.090	0.150	0.210					
NCP304HSQ45T1	4.410	4.5	4.590	0.135	0.225	0.315					
NCP304HSQ47T1	4.606	4.7	4.794	0.141	0.235	0.329	1.0	1.2	2.5	0.04	0.08

10. Condition 1: 0.9 – 2.9 V, V<sub>in</sub> = V<sub>DET-</sub> – 0.10 V; 3.0 – 3.9 V, V<sub>in</sub> = V<sub>DET-</sub> – 0.13 V; 4.0 – 4.9 V, V<sub>in</sub> = V<sub>DET-</sub> – 0.16 V  
 11. Condition 2: 0.9 – 4.9 V, V<sub>in</sub> = V<sub>DET-</sub> + 2.0 V  
 12. Condition 3: 0.9 – 1.4 V, V<sub>in</sub> = 1.5 V, V<sub>OUT</sub> = 0.5 V; 1.5 – 4.9 V, V<sub>in</sub> = 5.0 V, V<sub>OUT</sub> = 0.5 V, Active High 'H' Suffix Devices  
 13. Condition 4: 0.9 – 4.9 V, V<sub>in</sub> = 0.7 V, V<sub>OUT</sub> = 0.4 V, Active High 'H' Suffix Devices  
 14. Condition 5: 0.9 – 1.0 V, V<sub>in</sub> = 0.8 V, V<sub>OUT</sub> = GND; 1.1 – 1.5 V, V<sub>in</sub> = 1.0 V, V<sub>OUT</sub> = GND; 1.6 – 4.9 V, V<sub>in</sub> = 1.5 V, V<sub>OUT</sub> = GND, Active High 'H' Suffix Devices

# NCP304, NCP305

**Table 3. NCP305 SERIES ELECTRICAL CHARACTERISTIC TABLE FOR 0.9 – 4.9 V**

Part Number	Detector Threshold			Detector Threshold Hysteresis			Supply Current		N-Channel Sink Current					
							V <sub>in</sub> Low	V <sub>in</sub> High	V <sub>in</sub> Low	V <sub>in</sub> High				
	V <sub>DET-</sub> (V)			V <sub>HYS</sub> (V)			I <sub>in</sub> (μA) (Note 15)	I <sub>in</sub> (μA) (Note 16)	I <sub>OUT</sub> (mA) (Note 17)	I <sub>OUT</sub> (mA) (Note 18)				
	Min	Typ	Max	Min	Typ	Max	Typ	Typ	Typ	Typ				
NCP305LSQ09T1	0.882	0.9	0.918	0.027	0.045	0.063	0.8	0.9	0.05	0.5				
NCP305LSQ15T1	1.470	1.5	1.530	0.045	0.075	0.105								
NCP305LSQ16T1	1.568	1.6	1.632	0.048	0.080	0.112								
NCP305LSQ17T1	1.666	1.7	1.734	0.051	0.085	0.119								
NCP305LSQ18T1	1.764	1.8	1.836	0.054	0.090	0.126								
NCP305LSQ20T1	1.960	2.0	2.040	0.060	0.100	0.140	0.9	1.1	0.05	2.0				
NCP305LSQ22T1	2.156	2.2	2.244	0.066	0.110	0.154								
NCP305LSQ23T1	2.254	2.3	2.346	0.069	0.115	0.161								
NCP305LSQ24T1	2.352	2.4	2.448	0.072	0.120	0.168								
NCP305LSQ25T1	2.450	2.5	2.550	0.075	0.125	0.175								
NCP305LSQ26T1	2.548	2.6	2.652	0.078	0.130	0.182								
NCP305LSQ27T1	2.646	2.7	2.754	0.081	0.135	0.189								
NCP305LSQ28T1	2.744	2.8	2.856	0.084	0.140	0.196								
NCP305LSQ29T1	2.842	2.9	2.958	0.087	0.145	0.203								
NCP305LSQ30T1	2.940	3.0	3.060	0.090	0.150	0.210					1.0	1.2	0.05	2.0
NCP305LSQ31T1	3.038	3.1	3.162	0.093	0.155	0.217								
NCP305LSQ32T1	3.136	3.2	3.264	0.096	0.160	0.224								
NCP305LSQ33T1	3.234	3.3	3.366	0.099	0.165	0.231								
NCP305LSQ34T1	3.332	3.4	3.468	0.102	0.170	0.238								
NCP305LSQ35T1	3.430	3.5	3.570	0.105	0.175	0.245								
NCP305LSQ36T1	3.528	3.6	3.672	0.108	0.180	0.252								
NCP305LSQ37T1	3.626	3.7	3.774	0.111	0.185	0.259								
NCP305LSQ40T1	3.920	4.0	4.080	0.120	0.200	0.280	1.1	1.3	0.05	2.0				
NCP305LSQ44T1	4.312	4.4	4.488	0.132	0.220	0.308								
NCP305LSQ45T1	4.410	4.5	4.590	0.135	0.225	0.315								
NCP305LSQ47T1	4.606	4.7	4.794	0.141	0.235	0.329								
NCP305LSQ49T1	4.802	4.9	4.998	0.147	0.245	0.343								

15. Condition 1: 0.9 – 2.9 V, V<sub>in</sub> = V<sub>DET-</sub> – 0.10 V; 3.0 – 3.9 V, V<sub>in</sub> = V<sub>DET-</sub> – 0.13 V; 4.0 – 4.9 V, V<sub>in</sub> = V<sub>DET-</sub> – 0.16 V

16. Condition 2: 0.9 – 4.9 V, V<sub>in</sub> = V<sub>DET-</sub> + 2.0 V

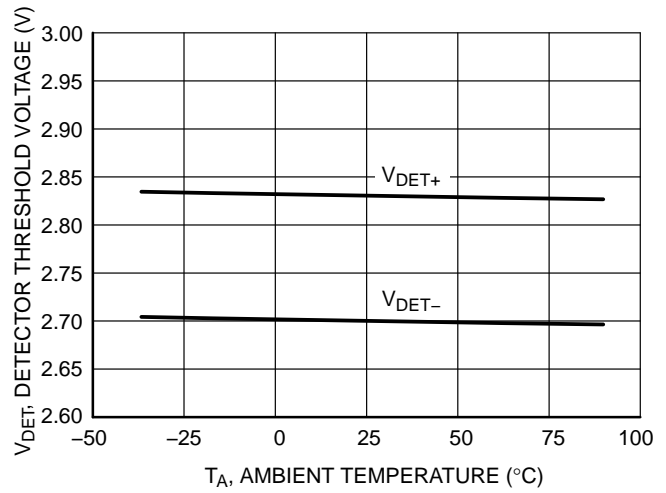
17. Condition 3: 0.9 – 4.9 V, V<sub>in</sub> = 0.7 V, V<sub>OUT</sub> = 0.05 V, Active Low 'L' Suffix Devices

18. Condition 4: 0.9 – 1.0 V, V<sub>in</sub> = 0.85 V, V<sub>OUT</sub> = 0.5 V; 1.1 – 1.5 V, V<sub>in</sub> = 1.0 V, V<sub>OUT</sub> = 0.5 V; 1.6 – 4.9 V, V<sub>in</sub> = 1.5 V, V<sub>OUT</sub> = 0.5 V, Active Low 'L' Suffix Devices

# NCP304, NCP305



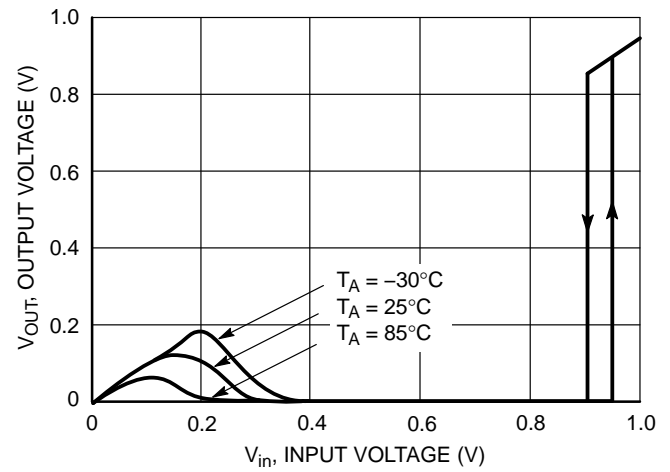
**Figure 3. NCP304/5 Series 0.9 V  
Detector Threshold Voltage vs. Temperature**



**Figure 4. NCP304/5 Series 2.7 V  
Detector Threshold Voltage vs. Temperature**



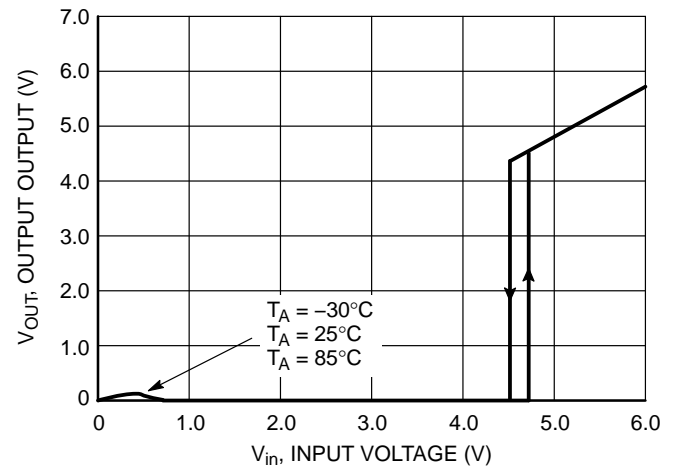
**Figure 5. NCP304/5 Series 4.5 V  
Detector Threshold Voltage vs. Temperature**



**Figure 6. NCP304L/5L Series 0.9 V  
Reset Output Voltage vs. Input Voltage**



**Figure 7. NCP304L/5L Series 2.7 V  
Reset Output Voltage vs. Input Voltage**



**Figure 8. NCP304L/5L Series 4.5 V  
Reset Output Voltage vs. Input Voltage**

# NCP304, NCP305



**Figure 9. NCP304H/5H Series 2.7 V Reset Output Voltage vs. Input Voltage**



**Figure 10. NCP304H/5L Series 0.9 V Reset Output Sink Current vs. Output Voltage**



**Figure 11. NCP304H/5L Series 2.7 V Reset Output Sink Current vs. Output Voltage**



**Figure 12. NCP304H/5L Series 4.5 V Reset Output Sink Current vs. Output Voltage**

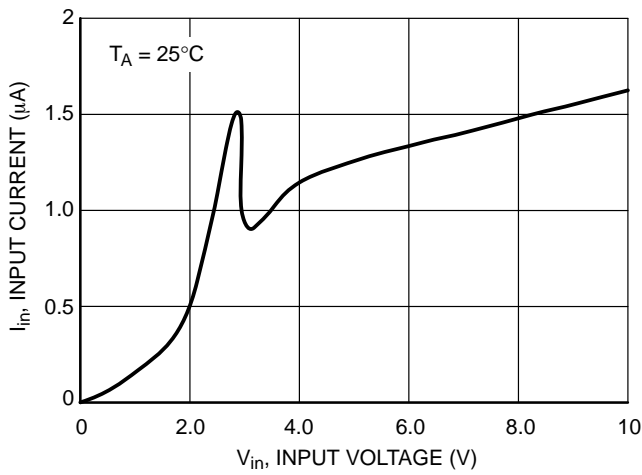


**Figure 13. NCP304H Series 2.7 V Reset Output Source Current vs. Output Voltage**

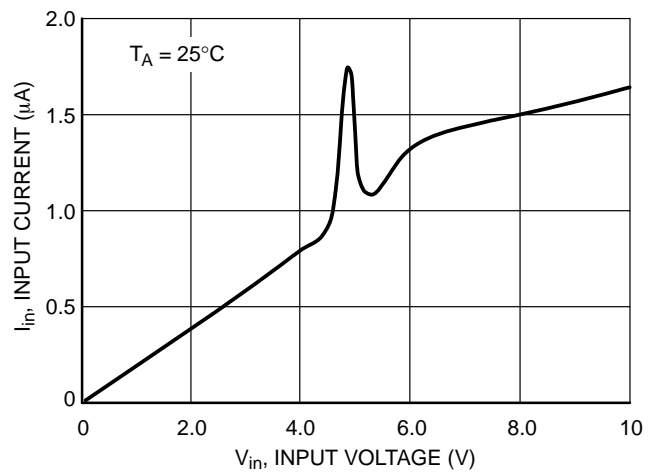


**Figure 14. NCP304/5 Series 0.9 V Input Current vs. Input Voltage**

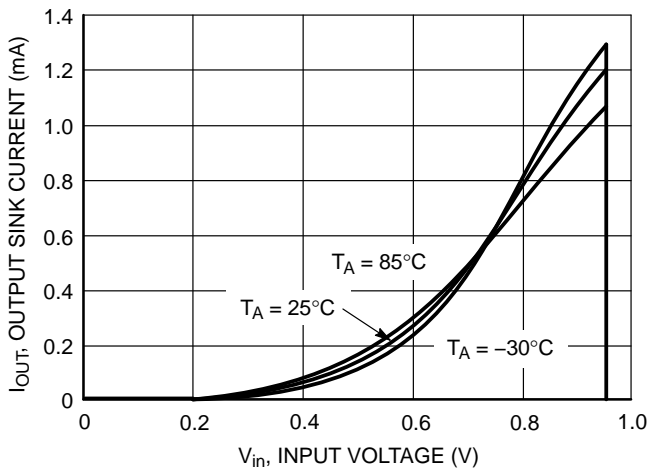
# NCP304, NCP305



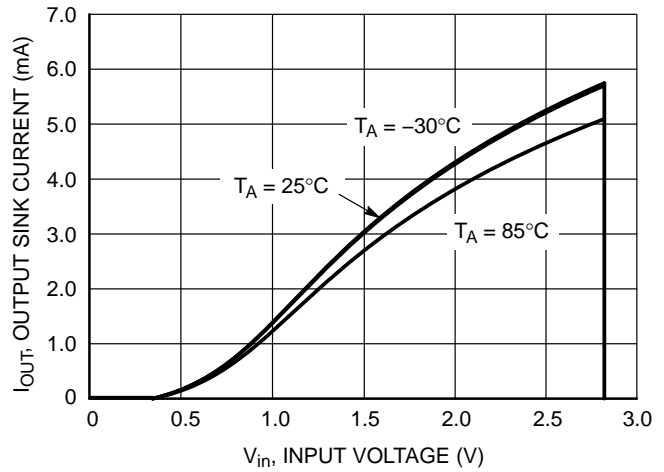
**Figure 15. NCP304/5 Series 2.7 V Input Current vs. Input Voltage**



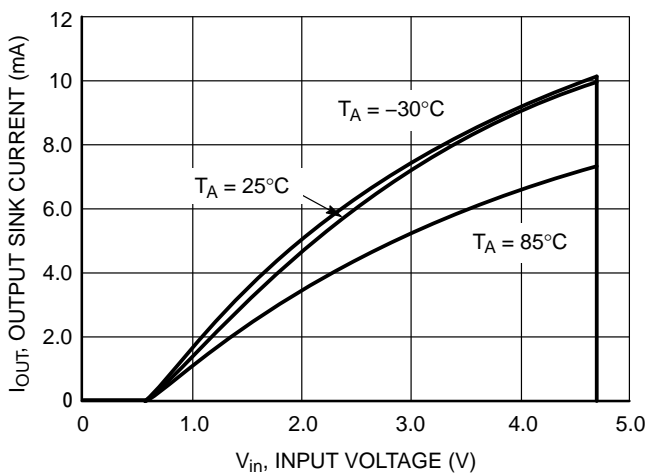
**Figure 16. NCP304/5 Series 4.5 V Input Current vs. Input Voltage**



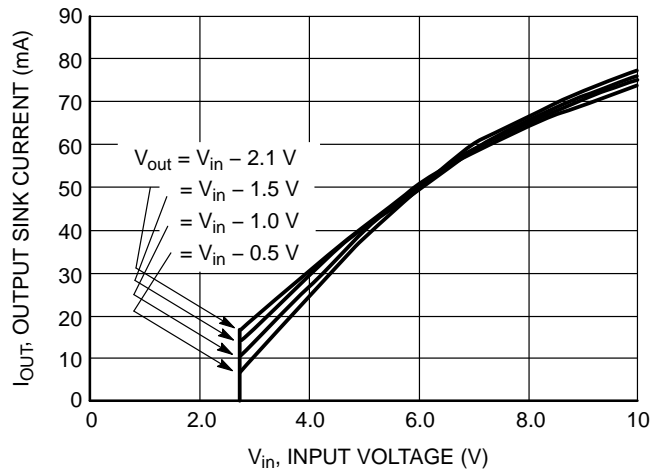
**Figure 17. NCP304H/5L Series 0.9 V Reset Output Sink Current vs. Input Voltage**



**Figure 18. NCP304H/5L Series 2.7 V Reset Output Sink Current vs. Input Voltage**

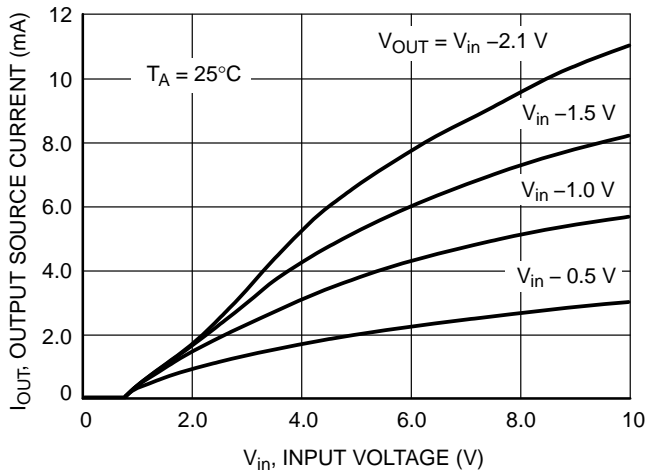


**Figure 19. NCP304H/5L Series 4.5 V Reset Output Sink Current vs. Input Voltage**

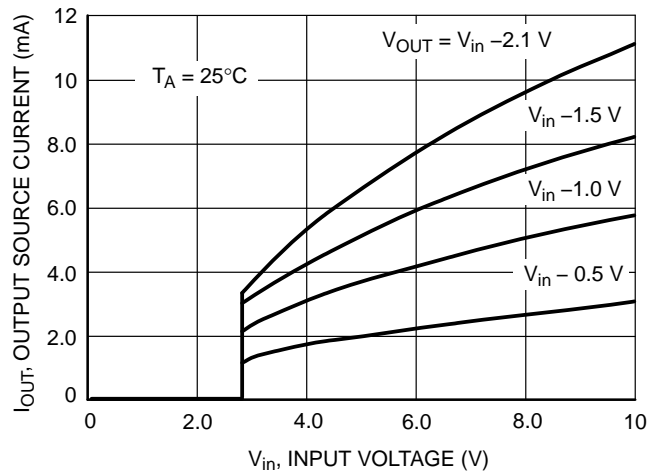


**Figure 20. NCP304H/5H Series 2.7 V Reset Output Sink Current vs. Input Voltage**

# NCP304, NCP305



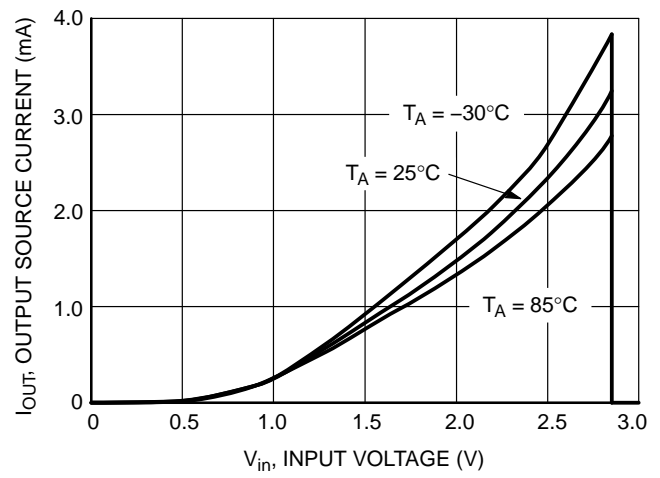
**Figure 21. NCP304H Series 0.9 V**  
Reset Output Source Current vs. Input Voltage



**Figure 22. NCP304H Series 2.7 V**  
Reset Output Source Current vs. Input Voltage



**Figure 23. NCP304H Series 4.5 V**  
Reset Output Source Current vs. Input Voltage



**Figure 24. NCP304H Series 2.7 V**  
Reset Output Source Current vs. Input Voltage

# NCP304, NCP305

## OPERATING DESCRIPTION

The NCP304 and NCP305 series devices are second generation ultra-low current voltage detectors. Figures 25 and 26 show a timing diagram and a typical application. Initially consider that input voltage  $V_{in}$  is at a nominal level and it is greater than the voltage detector upper threshold ( $V_{DET+}$ ), and the reset output (Pin 1) will be in the high state for active low devices, or in the low state for active high devices. If there is a power interruption and  $V_{in}$  becomes significantly deficient, it will fall below the lower detector threshold ( $V_{DET-}$ ). This sequence of events causes the Reset output to be in the low state for active low devices, or in the

high state for active high devices. After completion of the power interruption,  $V_{in}$  will again return to its nominal level and become greater than the  $V_{DET+}$ . The voltage detector has built-in hysteresis to prevent erratic reset operation as the comparator threshold is crossed.

Although these device series are specifically designed for use as reset controllers in portable microprocessor based systems, they offer a cost-effective solution in numerous applications where precise voltage monitoring is required. Figure 26 through Figure 32 shows various application examples.

"L" in Part Name	"H" in Part Name
Function: active Low Reset Output	Function: active High Reset Output
Input < $V_{det-}$ , Reset Output is Low	Input < $V_{det-}$ , Reset Output is High
Input > $V_{det+}$ , Reset Output is High	Input > $V_{det+}$ , Reset Output is Low

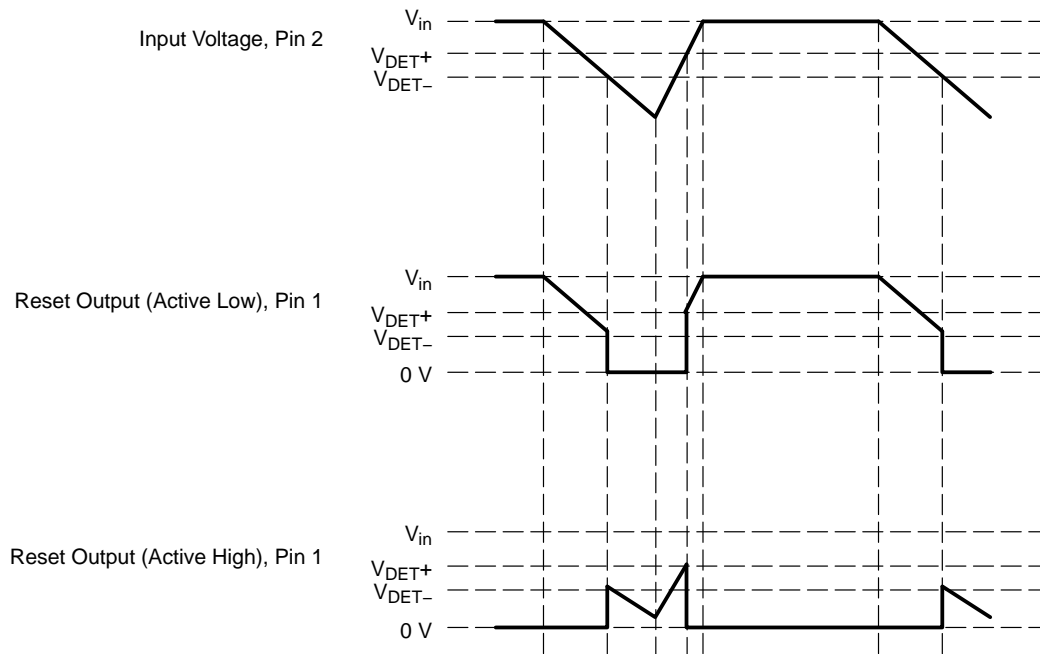


Figure 25. Timing Waveforms

# NCP304, NCP305

## APPLICATION CIRCUIT INFORMATION



Figure 26. Microprocessor Reset Circuit



Figure 27. Battery Charge Indicator



Figure 28. Dual Power Supply Undervoltage Supervision

## NCP304, NCP305



**Figure 29. Microprocessor Reset Circuit with Additional Hysteresis**

Comparator hysteresis can be increased with the addition of resistor  $R_H$ . The hysteresis equations have been simplified and do not account for the change of input current  $I_{in}$  as  $V_{in}$  crosses the comparator threshold. The internal resistance,  $R_{in}$  is simply calculated using  $I_{in} = 0.26 \mu A$  at 2.6 V.

$V_{in}$  Decreasing:

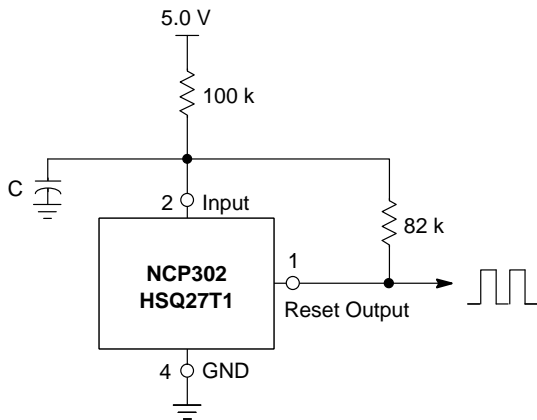
$$V_{th} = \left( \frac{R_H}{R_{in}} + 1 \right) (V_{DET-})$$

$V_{in}$  Increasing:

$$V_{th} = \left( \frac{R_H}{R_{in} \parallel R_L} + 1 \right) (V_{DET-} + V_{HYS})$$

$$V_{HYS} = V_{in \text{ Increasing}} - V_{in \text{ Decreasing}}$$

Test Data				
$V_{th}$ Decreasing (mV)	$V_{th}$ Increasing (mV)	$V_{HYS}$ (mV)	$R_H$ ( $\Omega$ )	$R_L$ (k $\Omega$ )
2.70	2.84	0.135	0	–
2.70	2.87	0.17	100	10
2.70	2.88	0.19	100	6.8
2.70	2.91	0.21	100	4.3
2.70	2.90	0.20	220	10
2.70	2.94	0.24	220	6.8
2.70	2.98	0.28	220	4.3
2.70	2.70	0.27	470	10
2.70	3.04	0.34	470	6.8
2.70	3.15	0.35	470	4.3



Test Data		
C ( $\mu F$ )	$f_{OSC}$ (kHz)	$I_Q$ ( $\mu A$ )
0.01	2590	21.77
0.1	490	21.97
1.0	52	22.07

**Figure 30. Simple Clock Oscillator**

## NCP304, NCP305



This circuit monitors the current at the load. As current flows through the load, a voltage drop with respect to ground appears across  $R_{sense}$  where  $V_{sense} = I_{load} * R_{sense}$ . The following conditions apply:

If:	Then:
$I_{Load} < V_{DET-} / R_{sense}$	Reset Output = 0 V
$I_{Load} \geq (V_{DET-} + V_{HYS}) / R_{sense}$	Reset Output = $V_{DD}$

Figure 31. Microcontroller Systems Load Sensing



A simple voltage monitor can be constructed by connecting several voltage detectors as shown above. Each LED will sequentially turn on when the respective voltage detector threshold ( $V_{DET-} + V_{HYS}$ ) is exceeded. Note that detector thresholds ( $V_{DET-}$ ) that range from 0.9 V to 4.9 V in 100 mV steps can be manufactured.

Figure 32. LED Bar Graph

# NCP304, NCP305

## ORDERING INFORMATION

Device	Threshold Voltage	Output Type	Reset	Marking	Package	Shipping <sup>†</sup>
NCP304LSQ09T1G	0.9	CMOS	Active Low	SHG	SC-82AB (Pb-Free)	3000 / Tape & Reel
NCP304LSQ18T1G	1.8			SGX		
NCP304LSQ20T1G	2.0			SGV		
NCP304LSQ23T1G	2.3			SGR		
NCP304LSQ25T1G	2.5			SGP		
NCP304LSQ27T1G	2.7			SGN		
NCP304LSQ280T1G	2.8			CAT		
NCP304LSQ29T1G	2.9			SGK		
NCP304LSQ30T1G	3.0			SGJ		
NCV304LSQ30T1G*	3.0			ACT		
NCP304LSQ33T1G	3.3			SGG		
NCV304LSQ33T1G*	3.3			AGA		
NCP304LSQ37T1G	3.7			SGB		
NCP304LSQ38T1G	3.8			SGA		
NCP304LSQ40T1G	4.0			SFY		
NCP304LSQ42T1G	4.2			SFU		
NCP304LSQ43T1G	4.3			SFV		
NCP304LSQ45T1G	4.5			SFS		
NCP304LSQ46T1G	4.6			SFR		
NCP304LSQ47T1G	4.7			SFQ		
NCP304HSQ09T1G	0.9	CMOS	Active High	SNQ		
NCP304HSQ18T1G	1.8			SNZ		
NCP304HSQ20T1G	2.0			SOB		
NCP304HSQ22T1G	2.2			SOD		
NCP304HSQ27T1G	2.7			SOI		
NCP304HSQ29T1G	2.9			SOK		
NCP304HSQ30T1G	3.0			SOL		
NCP304HSQ45T1G	4.5			SPA		
NCP304HSQ47T1G	4.7			SPC		

NOTE: The ordering information lists standard undervoltage thresholds with active low outputs. Additional active low threshold devices, ranging from 0.9 V to 4.9 V in 100 mV increments and NCP304 active high output devices, ranging from 0.9 V to 4.9 V in 100 mV increments can be manufactured. Contact your ON Semiconductor representative for availability. The electrical characteristics of these additional devices are shown in Tables 1 and 2.

<sup>†</sup>For information on tape and reel specifications, including part orientation and tape sizes, please refer to our Tape and Reel Packaging Specifications Brochure, BRD8011/D.

\*NCV Prefix for Automotive and Other Applications Requiring Unique Site and Control Change Requirements; AEC-Q100 Qualified and PPAP Capable.

NCVxxx: T<sub>low</sub> = -40°C, T<sub>high</sub> = +125°C. Guaranteed by design.

# NCP304, NCP305

## ORDERING INFORMATION

Device	Threshold Voltage	Output Type	Reset	Marking	Package	Shipping†
NCP305LSQ09T1G	0.9	Open Drain	Active Low	SIZ	SC-82AB (Pb-Free)	3000 / Tape & Reel
NCP305LSQ11T1G	1.1			SIX		
NCV305LSQ11T1G*	1.1			TAP		
NCP305LSQ15T1G	1.5			SIS		
NCP305LSQ16T1G	1.6			SIR		
NCP305LSQ17T1G	1.7			SIQ		
NCP305LSQ18T1G	1.8			SIP		
NCP305LSQ20T1G	2.0			SIN		
NCV305LSQ20T1G*	2.0			AAJ		
NCP305LSQ22T1G	2.2			SIK		
NCP305LSQ23T1G	2.3			SIJ		
NCV305LSQ23T1G*	2.3			AUT		
NCP305LSQ24T1G	2.4			SII		
NCP305LSQ25T1G	2.5			SIH		
NCP305LSQ26T1G	2.6			SIG		
NCP305LSQ27T1G	2.7			SIF		
NCP305LSQ28T1G	2.8			SIE		
NCP305LSQ29T1G	2.9			SID		
NCP305LSQ30T1G	3.0			SIC		
NCP305LSQ30T3G	3.0			SIC		10,000 / Tape & Reel
NCP305LSQ31T1G	3.1			SIB		3000 / Tape & Reel
NCP305LSQ32T1G	3.2			SIA		
NCP305LSQ33T1G	3.3			SHZ		
NCP305LSQ34T1G	3.4			SHY		
NCP305LSQ35T1G	3.5			SHX		
NCP305LSQ36T1G	3.6			SHU		
NCP305LSQ37T1G	3.7			SHV		
NCP305LSQ40T1G	4.0			SHR		
NCP305LSQ44T1G	4.4			SHN		
NCV305LSQ44T1G*	4.4			AAH		
NCP305LSQ45T1G	4.5	SHL				
NCP305LSQ47T1G	4.7	SHJ				
NCP305LSQ49T1G	4.9	SHH				

NOTE: The ordering information lists standard undervoltage thresholds with active low outputs. Additional active low threshold devices, ranging from 0.9 V to 4.9 V in 100 mV increments and NCP304 active high output devices, ranging from 0.9 V to 4.9 V in 100 mV increments can be manufactured. Contact your ON Semiconductor representative for availability. The electrical characteristics of these additional devices are shown in Tables 1 and 2.

†For information on tape and reel specifications, including part orientation and tape sizes, please refer to our Tape and Reel Packaging Specifications Brochure, BRD8011/D.

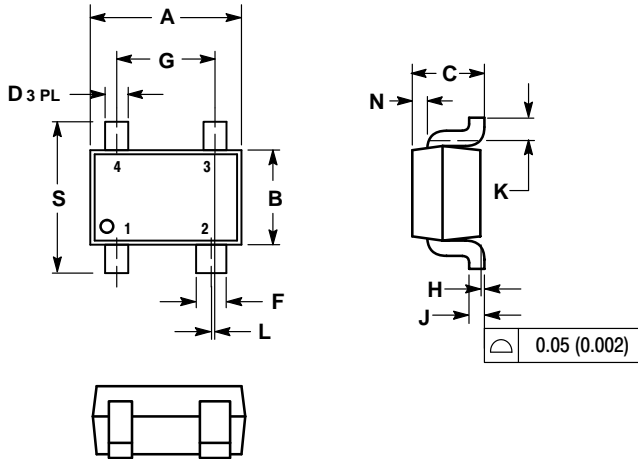
\*NCV Prefix for Automotive and Other Applications Requiring Unique Site and Control Change Requirements; AEC-Q100 Qualified and PPAP Capable.

NCVxxx:  $T_{low} = -40^{\circ}\text{C}$ ,  $T_{high} = +125^{\circ}\text{C}$ . Guaranteed by design.

# NCP304, NCP305

## PACKAGE DIMENSIONS

**SC-82AB**  
**SQ SUFFIX**  
 CASE 419C-02  
 ISSUE F

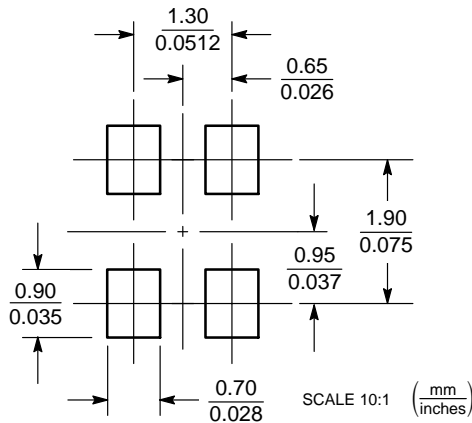


**NOTES:**

1. DIMENSIONING AND TOLERANCING PER ANSI Y14.5M, 1982.
2. CONTROLLING DIMENSION: MILLIMETER.
3. 419C-01 OBSOLETE. NEW STANDARD IS 419C-02.
4. DIMENSIONS A AND B DO NOT INCLUDE MOLD FLASH, PROTRUSIONS, OR GATE BURRS.

DIM	MILLIMETERS		INCHES	
	MIN	MAX	MIN	MAX
A	1.80	2.20	0.071	0.087
B	1.15	1.35	0.045	0.053
C	0.80	1.10	0.031	0.043
D	0.20	0.40	0.008	0.016
F	0.30	0.50	0.012	0.020
G	1.10	1.50	0.043	0.059
H	0.00	0.10	0.000	0.004
J	0.10	0.26	0.004	0.010
K	0.10	—	0.004	—
L	0.05 BSC		0.002 BSC	
N	0.20 REF		0.008 REF	
S	1.80	2.40	0.07	0.09

### SOLDERING FOOTPRINT\*



\*For additional information on our Pb-Free strategy and soldering details, please download the ON Semiconductor Soldering and Mounting Techniques Reference Manual, SOLDERRM/D.

ON Semiconductor and the are registered trademarks of Semiconductor Components Industries, LLC (SCILLC) or its subsidiaries in the United States and/or other countries. SCILLC owns the rights to a number of patents, trademarks, copyrights, trade secrets, and other intellectual property. A listing of SCILLC's product/patent coverage may be accessed at [www.onsemi.com/site/pdf/Patent-Marking.pdf](http://www.onsemi.com/site/pdf/Patent-Marking.pdf). SCILLC reserves the right to make changes without further notice to any products herein. SCILLC makes no warranty, representation or guarantee regarding the suitability of its products for any particular purpose, nor does SCILLC assume any liability arising out of the application or use of any product or circuit, and specifically disclaims any and all liability, including without limitation special, consequential or incidental damages. "Typical" parameters which may be provided in SCILLC data sheets and/or specifications can and do vary in different applications and actual performance may vary over time. All operating parameters, including "Typicals" must be validated for each customer application by customer's technical experts. SCILLC does not convey any license under its patent rights nor the rights of others. SCILLC products are not designed, intended, or authorized for use as components in systems intended for surgical implant into the body, or other applications intended to support or sustain life, or for any other application in which the failure of the SCILLC product could create a situation where personal injury or death may occur. Should Buyer purchase or use SCILLC products for any such unintended or unauthorized application, Buyer shall indemnify and hold SCILLC and its officers, employees, subsidiaries, affiliates, and distributors harmless against all claims, costs, damages, and expenses, and reasonable attorney fees arising out of, directly or indirectly, any claim of personal injury or death associated with such unintended or unauthorized use, even if such claim alleges that SCILLC was negligent regarding the design or manufacture of the part. SCILLC is an Equal Opportunity/Affirmative Action Employer. This literature is subject to all applicable copyright laws and is not for resale in any manner.

### PUBLICATION ORDERING INFORMATION

**LITERATURE FULFILLMENT:**

Literature Distribution Center for ON Semiconductor  
 P.O. Box 5163, Denver, Colorado 80217 USA  
**Phone:** 303-675-2175 or 800-344-3860 Toll Free USA/Canada  
**Fax:** 303-675-2176 or 800-344-3867 Toll Free USA/Canada  
**Email:** [orderlit@onsemi.com](mailto:orderlit@onsemi.com)

**N. American Technical Support:** 800-282-9855 Toll Free  
 USA/Canada  
**Europe, Middle East and Africa Technical Support:**  
 Phone: 421 33 790 2910  
**Japan Customer Focus Center**  
 Phone: 81-3-5817-1050

**ON Semiconductor Website:** [www.onsemi.com](http://www.onsemi.com)

**Order Literature:** <http://www.onsemi.com/orderlit>

For additional information, please contact your local Sales Representative

## Looking for pricing, stock, or lifecycle information?

Click below to explore more details on WIN SOURCE:

 [View NCP304HSQ27T1G on WIN SOURCE](#)

 [ON Semiconductor](#) Information

## Optimize Your Supply Chain with WIN SOURCE Solutions

-  Global Sourcing Solution
-  Obsolete Management
-  Cost Control Management
-  Shortage Management
-  Alternative Solution
-  Excess Inventory Management