



**THE DATASHEET OF
NCP1200AD100R2**



NCP1200A

PWM Current-Mode Controller for Universal Off-Line Supplies Featuring Low Standby Power

Housed in SOIC-8 or PDIP-8 package, the NCP1200A enhances the previous NCP1200 series by offering a reduced optocoupler current together with an increased drive capability. Due to its novel concept, the circuit allows the implementation of complete off-line AC-DC adapters, battery charger or a SMPS where standby power is a key parameter.

With an internal structure operating at a fixed 40 kHz, 60 kHz or 100 kHz, the controller supplies itself from the high-voltage rail, avoiding the need of an auxiliary winding. This feature naturally eases the designer task in battery charger applications. Finally, current-mode control provides an excellent audio-susceptibility and inherent pulse-by-pulse control.

When the current setpoint falls below a given value, e.g. the output power demand diminishes, the IC automatically enters the so-called skip cycle mode and provides excellent efficiency at light loads. Because this occurs at a user adjustable low peak current, no acoustic noise takes place.

The NCP1200A features an efficient protective circuitry which, in presence of an overcurrent condition, disables the output pulses while the device enters a safe burst mode, trying to restart. Once the default has gone, the device auto-recovers.

Features

- Pb-Free Packages are Available
- No Auxiliary Winding Operation
- Auto-Recovery Internal Output Short-Circuit Protection
- Extremely Low No-Load Standby Power
- Current-Mode Control with Skip-Cycle Capability
- Internal Temperature Shutdown
- Internal Leading Edge Blanking
- 250 mA Peak Current Capability
- Internally Fixed Frequency at 40 kHz, 60 kHz and 100 kHz
- Direct Optocoupler Connection
- SPICE Models Available for TRANSient and AC Analysis
- Pin to Pin Compatible with NCP1200

Typical Applications

- AC-DC Adapters for Portable Devices
- Offline Battery Chargers
- Auxiliary Power Supplies (USB, Appliances, TVs, etc.)



ON Semiconductor®

<http://onsemi.com>

MINIATURE PWM CONTROLLER FOR HIGH POWER AC-DC WALL ADAPTERS AND OFFLINE BATTERY CHARGERS

MARKING DIAGRAMS



SOIC-8
D SUFFIX
CASE 751

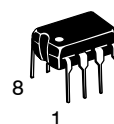
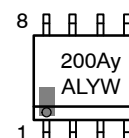

PDIP-8
P SUFFIX
CASE 626

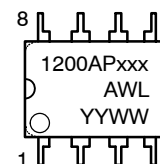

xxx = Specific Device Code (40, 60 or 100)
y = Specific Device Code (4 for 40, 6 for 60, 1 for 100)
A = Assembly Location
WL, L = Wafer Lot
Y, YY = Year
W, WW = Work Week

PIN CONNECTIONS

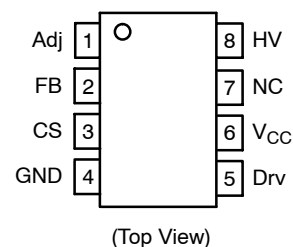

ORDERING INFORMATION

See detailed ordering and shipping information in the package dimensions section on page 14 of this data sheet.

NCP1200A

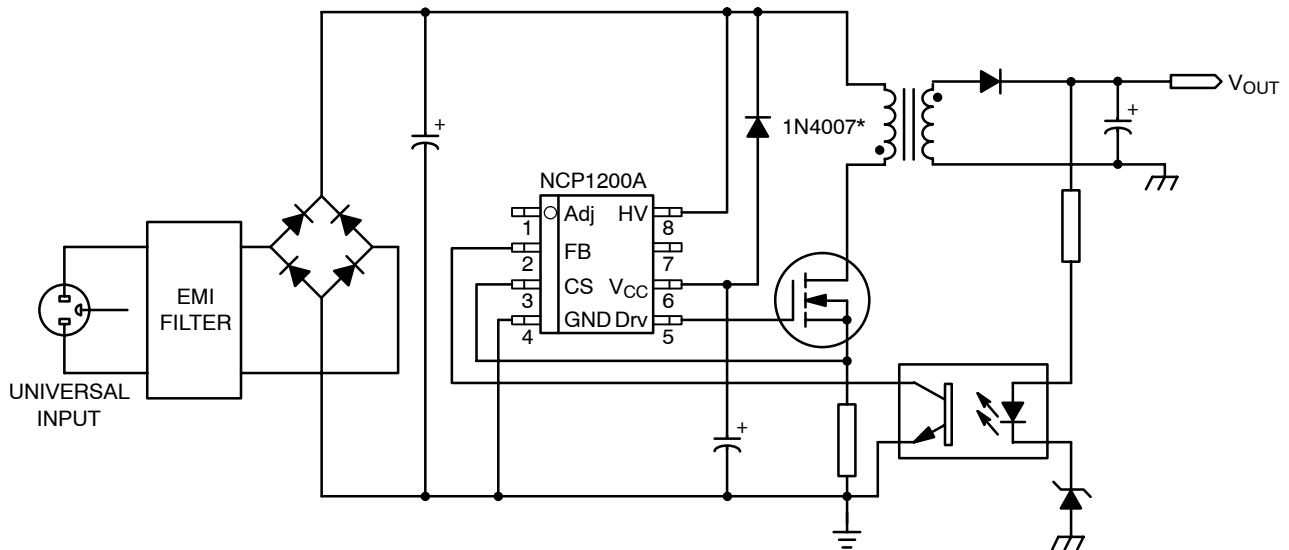

*Please refer to the application information section.

Figure 1. Typical Application Example

PIN FUNCTION DESCRIPTION

Pin No.	Pin Name	Function	Pin Description
1	Adj	Adjust the skipping peak current	This pin lets you adjust the level at which the cycle skipping process takes place. Shorting this pin to ground, permanently disables the skip cycle feature.
2	FB	Sets the peak current setpoint	By connecting an optocoupler to this pin, the peak current setpoint is adjusted accordingly to the output power demand.
3	CS	Current sense input	This pin senses the primary current and routes it to the internal comparator via an L.E.B.
4	GND	The IC ground	-
5	Drv	Driving pulses	The driver's output to an external MOSFET.
6	V _{CC}	Supplies the IC	This pin is connected to an external bulk capacitor of typically 10 μ F.
7	NC	-	This unconnected pin ensures adequate creepage distance.
8	HV	Generates the V _{CC} from the line	Connected to the high-voltage rail, this pin injects a constant current into the V _{CC} bulk capacitor.

NCP1200A

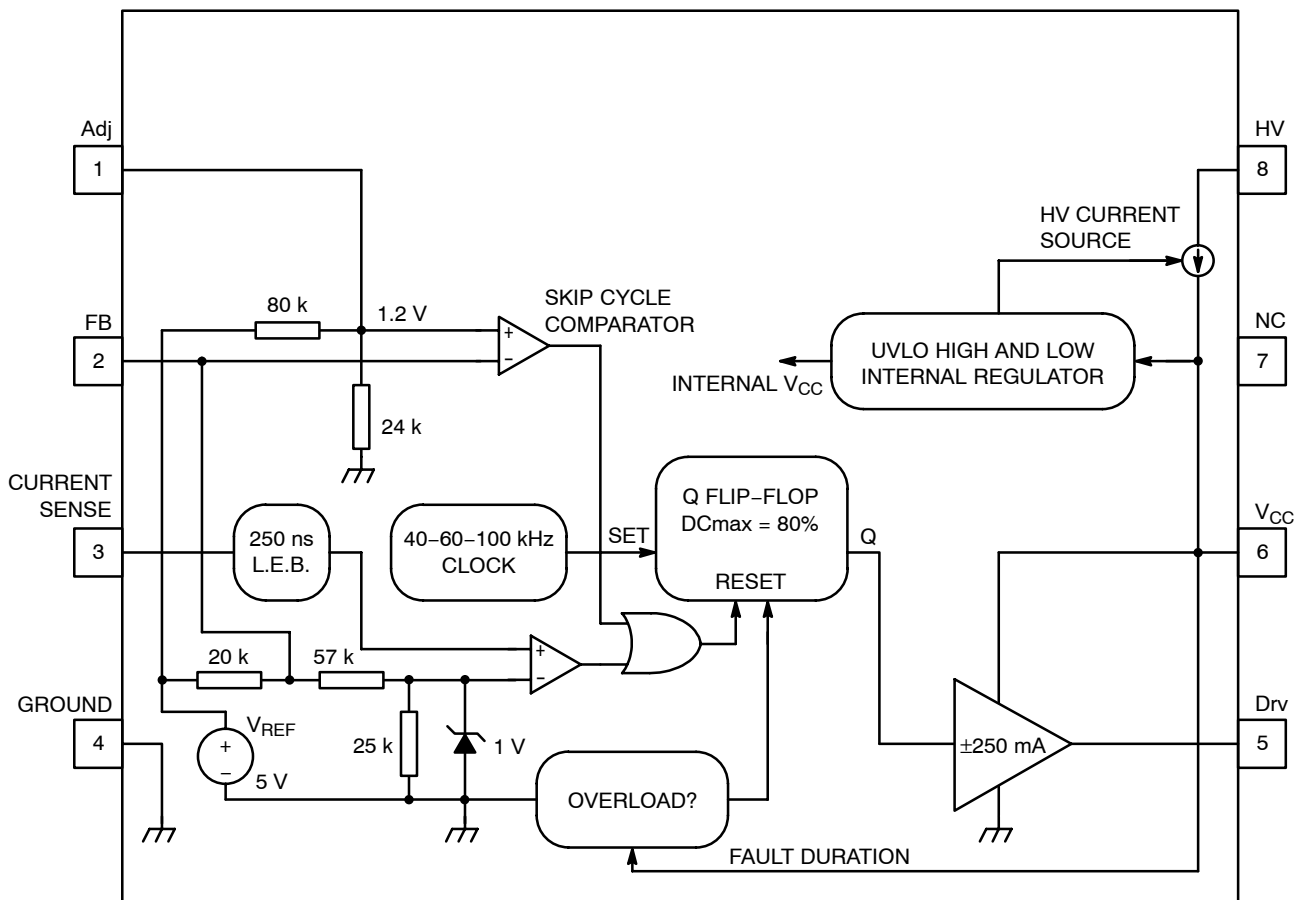

Figure 2. Internal Circuit Architecture

MAXIMUM RATINGS

Rating	Symbol	Value	Unit
Power Supply Voltage	V_{CC}	16	V
Thermal Resistance Junction-to-Air, PDIP-8 Version	$R_{\theta JA}$	100	$^{\circ}\text{C}/\text{W}$
Thermal Resistance Junction-to-Air, SOIC Version	$R_{\theta JA}$	178	$^{\circ}\text{C}/\text{W}$
Maximum Junction Temperature	$T_{J(\text{max})}$	150	$^{\circ}\text{C}$
Temperature Shutdown	-	145	$^{\circ}\text{C}$
Storage Temperature Range	-	-60 to +150	$^{\circ}\text{C}$
ESD Capability, Human Body Model Model (All pins except V_{CC} and HV)	-	2.0	kV
ESD Capability, Machine Model	-	200	V
Maximum Voltage on Pin 8 (HV), Pin 6 (V_{CC}) Grounded	-	450	V
Maximum Voltage on Pin 8 (HV), Pin 6 (V_{CC}) Decoupled to Ground with 10 μF	-	500	V
Minimum Operating Voltage on Pin 8 (HV)	-	40	V

Maximum ratings are those values beyond which device damage can occur. Maximum ratings applied to the device are individual stress limit values (not normal operating conditions) and are not valid simultaneously. If these limits are exceeded, device functional operation is not implied, damage may occur and reliability may be affected.

NCP1200A

ELECTRICAL CHARACTERISTICS (For typical values $T_J = 25^\circ\text{C}$, for min/max values $T_J = 0^\circ\text{C}$ to $+125^\circ\text{C}$, Max $T_J = 150^\circ\text{C}$, $V_{CC} = 11\text{ V}$ unless otherwise noted.)

Characteristic	Symbol	Pin	Min	Typ	Max	Unit
----------------	--------	-----	-----	-----	-----	------

Dynamic Self-Supply (All frequency versions, otherwise noted)

V_{CC} Increasing Level at which the Current Source Turns-Off	$V_{CC(\text{off})}$	6	11.2	12.1	13.1	V
V_{CC} Decreasing Level at which the Current Source Turns-On	$V_{CC(\text{on})}$	6	9.0	10	11	V
V_{CC} Decreasing Level at which the Latchoff Phase Ends	$V_{CC(\text{latch})}$	6	-	5.4	-	V
Internal IC Consumption, No Output Load on Pin 5	ICC1	6	-	750	1000 (Note 1)	μA
Internal IC Consumption, 1.0 nF Output Load on Pin 5, $F_{\text{SW}} = 40\text{ kHz}$	ICC2	6	-	1.2	1.4 (Note 2)	mA
Internal IC Consumption, 1.0 nF Output Load on Pin 5, $F_{\text{SW}} = 60\text{ kHz}$	ICC2	6	-	1.4	1.6 (Note 2)	mA
Internal IC Consumption, 1.0 nF Output Load on Pin 5, $F_{\text{SW}} = 100\text{ kHz}$	ICC2	6	-	1.9	2.2 (Note 2)	mA
Internal IC Consumption, Latchoff Phase	ICC3	6	-	350	-	μA

Internal Startup Current Source ($T_J > 0^\circ\text{C}$, pin 8 biased at 50 V)

High-Voltage Current Source, $V_{CC} = 10\text{ V}$	IC1	8	4.0	7.0	-	mA
High-Voltage Current Source, $V_{CC} = 0$	IC2	8	-	13	-	mA

Drive Output

Output Voltage Rise-Time @ $CL = 1.0\text{ nF}$, 10-90% of Output Signal	T_r	5	-	67	-	ns
Output Voltage Fall-Time @ $CL = 1.0\text{ nF}$, 10-90% of Output Signal	T_f	5	-	25	-	ns
Source Resistance	R_{OH}	5	27	40	61	Ω
Sink Resistance	R_{OL}	5	5.0	10	21	Ω

Current Comparator (Pin 5 unloaded unless otherwise noted)

Input Bias Current @ 1.0 V Input Level on Pin 3	I_{IB}	3	-	0.02	-	μA
Maximum Internal Current Setpoint (Note 3)	I_{Limit}	3	0.8	0.9	1.0	V
Default Internal Current Setpoint for Skip Cycle Operation	I_{Lskip}	3	-	360	-	mV
Propagation Delay from Current Detection to Gate OFF State	T_{DEL}	3	-	90	160	ns
Leading Edge Blanking Duration (Note 3)	T_{LEB}	3	-	250	-	ns

Internal Oscillator ($V_{CC} = 11\text{ V}$, pin 5 loaded by 1.0 k Ω)

Oscillation Frequency, 40 kHz Version	f_{OSC}	-	37	43	48	kHz
Built-in Frequency Jittering, $f_{\text{SW}} = 40\text{ kHz}$	f_{jitter}	-	-	350	-	kHz
Oscillation Frequency, 60 kHz Version	f_{OSC}	-	53	61	68	kHz
Built-in Frequency Jittering, $f_{\text{SW}} = 60\text{ kHz}$	f_{jitter}	-	-	460	-	kHz
Oscillation Frequency, 100 kHz Version	f_{OSC}	-	90	103	114	kHz
Built-in Frequency Jittering, $f_{\text{SW}} = 100\text{ kHz}$	f_{jitter}	-	-	620	-	kHz
Maximum Duty Cycle	Dmax	-	74	83	87	%

Feedback Section ($V_{CC} = 11\text{ V}$, pin 5 unloaded)

Internal Pullup Resistor	R_{Up}	2	-	20	-	k Ω
Pin 3 to Current Setpoint Division Ratio	I_{ratio}	-	-	3.3	-	-

Skip Cycle Generation

Default Skip Mode Level	V_{skip}	1	0.95	1.2	1.45	V
Pin 1 Internal Output Impedance	Z_{out}	1	-	22	-	k Ω

1. Max value at $T_J = 0^\circ\text{C}$.
2. Maximum value @ $T_J = 25^\circ\text{C}$, please see characterization curves.
3. Pin 5 loaded by 1.0 nF.

NCP1200A

TYPICAL CHARACTERISTICS

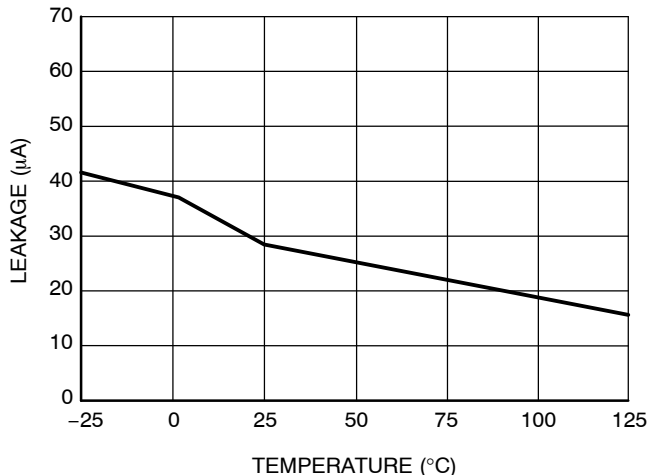

Figure 3. HV Pin Leakage Current vs. Temperature

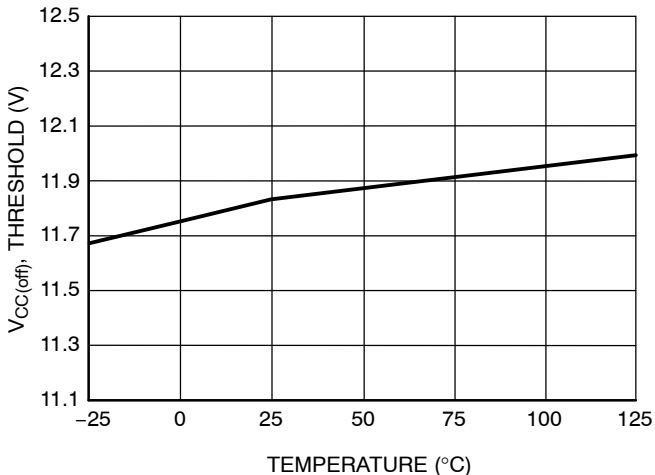

Figure 4. V_{CC(off)} vs. Temperature

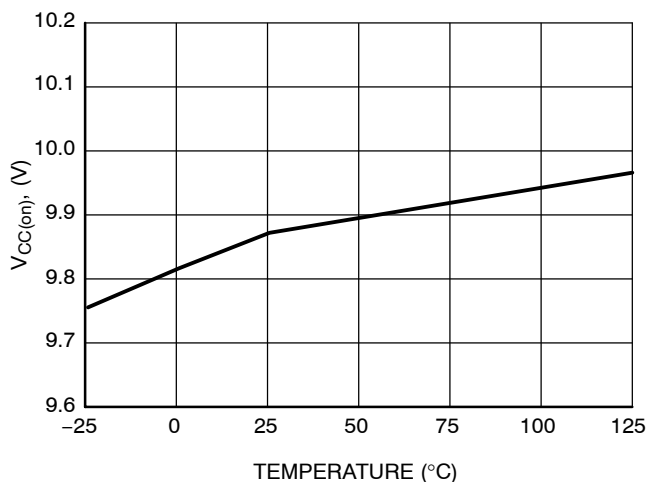

Figure 5. V_{CC(on)} vs. Temperature

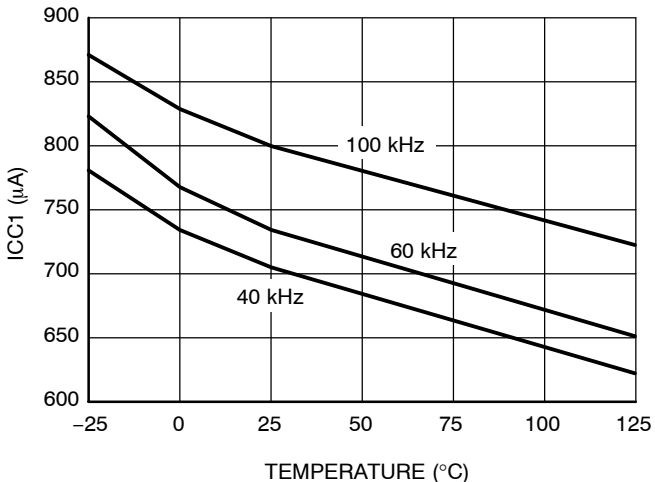

Figure 6. ICC1 vs. Temperature

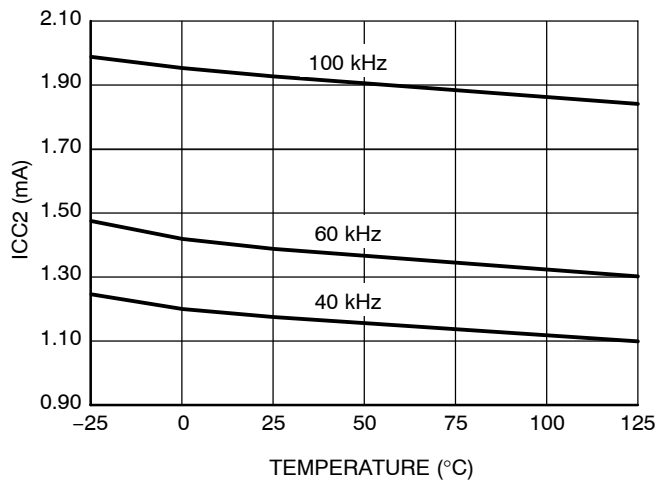

Figure 7. ICC2 vs. Temperature

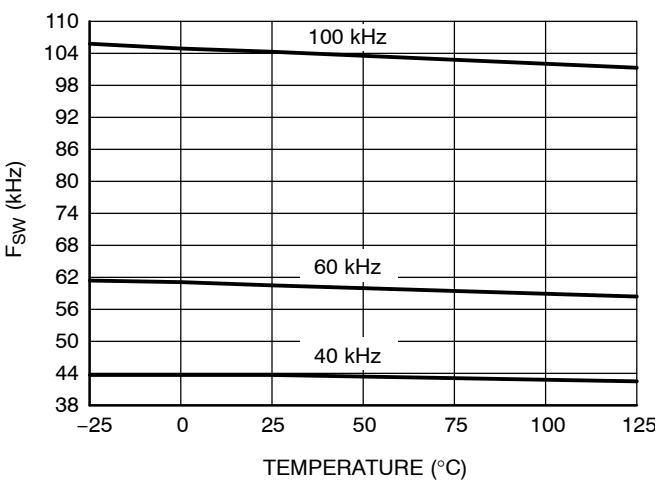

Figure 8. Switching Frequency vs. Temperature

NCP1200A

TYPICAL CHARACTERISTICS

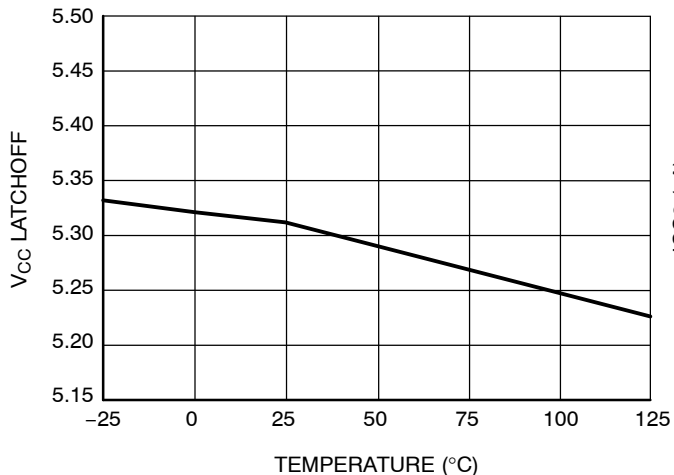

Figure 9. V_{CC} Latchoff vs. Temperature

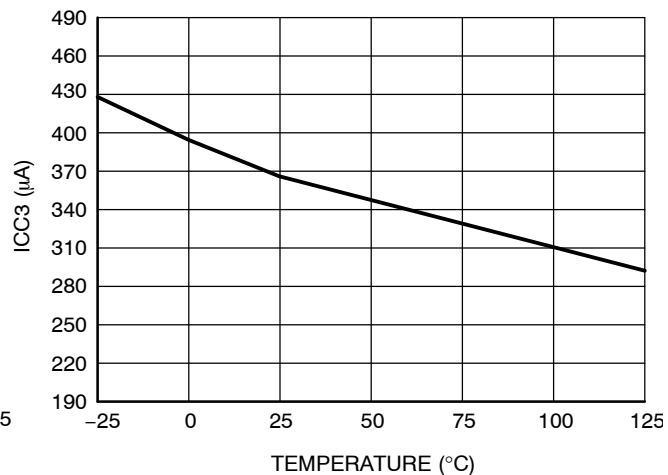

Figure 10. ICC3 vs. Temperature

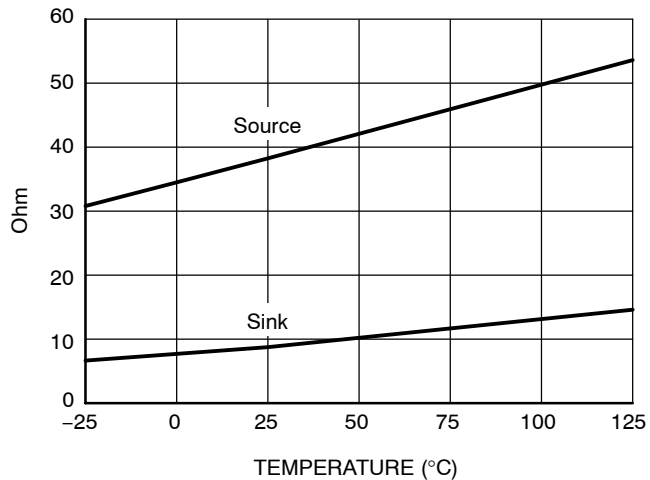

Figure 11. Drive and Source Resistance vs. Temperature

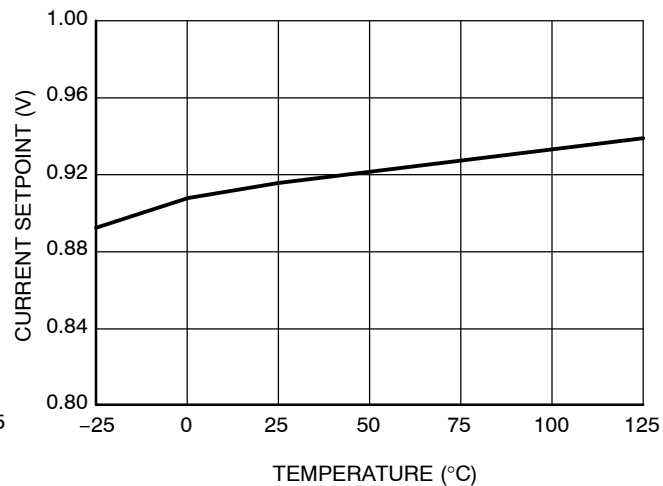

Figure 12. Current Sense Limit vs. Temperature

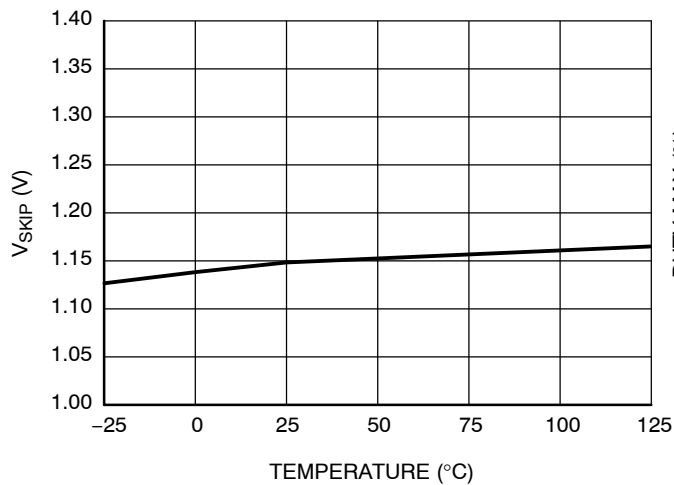

Figure 13. V_{SKIP} vs. Temperature

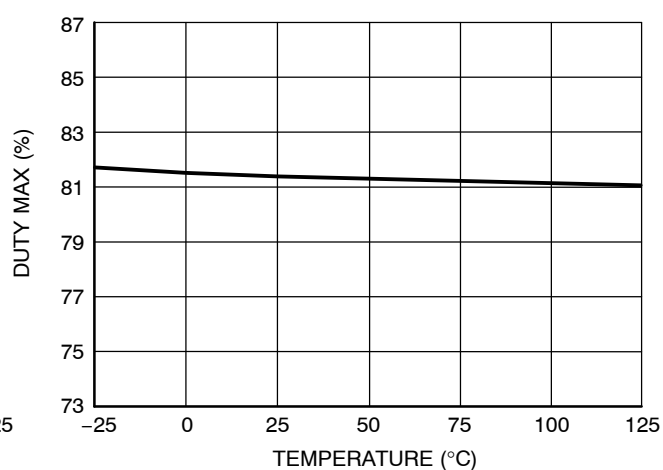

Figure 14. Max Duty Cycle vs. Temperature

APPLICATION INFORMATION

Introduction

The NCP1200A implements a standard current mode architecture where the switch-off time is dictated by the peak current setpoint. This component represents the ideal candidate where low part-count is the key parameter, particularly in low-cost AC-DC adapters, auxiliary supplies, etc. Due to its high-performance High-Voltage technology, the NCP1200A incorporates all the necessary components normally needed in UC384X based supplies: timing components, feedback devices, low-pass filter and self-supply. This later point emphasizes the fact that ON Semiconductor's NCP1200A does NOT need an auxiliary winding to operate: the product is naturally supplied from the high-voltage rail and delivers a V_{CC} to the IC. This system is called the Dynamic Self-Supply (DSS).

Dynamic Self-Supply

The DSS principle is based on the charge/discharge of the V_{CC} bulk capacitor from a low level up to a higher level. We can easily describe the current source operation with a bunch of simple logical equations:

POWER-ON: IF $V_{CC} < V_{CC_H}$ THEN Current Source is ON, no output pulses

IF V_{CC} decreasing $> V_{CC_L}$ THEN Current Source is OFF, output is pulsing

IF V_{CC} increasing $< V_{CC_H}$ THEN Current Source is ON, output is pulsing

Typical values are: $V_{CC_H} = 12\text{ V}$, $V_{CC_L} = 10\text{ V}$

To better understand the operational principle, Figure 15's sketch offers the necessary light:

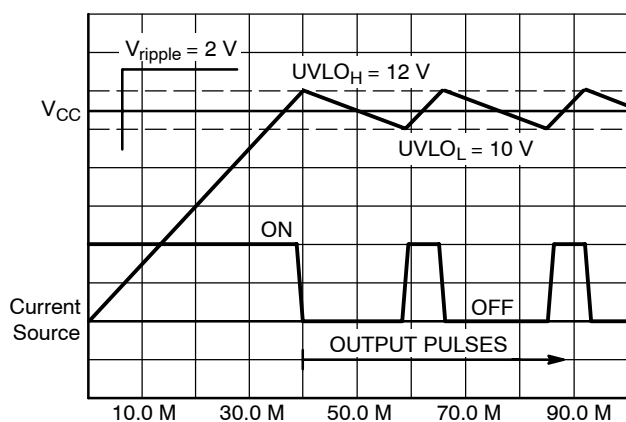

Figure 15. The charge/discharge cycle over a $10\ \mu\text{F}$ V_{CC} capacitor

The DSS behavior actually depends on the internal IC consumption and the MOSFETs gate charge Q_g . If we select a MOSFET like the MTP2N60E, Q_g max equals 22 nC. With a maximum switching frequency of 68 kHz for the P60 version, the average power necessary to drive the MOSFET (excluding the driver efficiency and neglecting various voltage drops) is:

$F_{SW} \cdot Q_g \cdot V_{CC}$ with

F_{SW} = maximum switching frequency

Q_g = MOSFETs gate charge

V_{CC} = V_{GS} level applied to the gate

To obtain the final IC current, simply divide this result by V_{CC} : $I_{driver} = F_{SW} \cdot Q_g = 1.5\text{ mA}$. The total standby power consumption at no-load will therefore heavily rely on the internal IC consumption plus the above driving current (altered by the driver's efficiency). Suppose that the IC is supplied from a 350 VDC line. The current flowing through pin 8 is a direct image of the NCP1200A consumption (neglecting the switching losses of the HV current source). If I_{CC2} equals 2.3 mA @ $T_J = 25^\circ\text{C}$, then the power dissipated (lost) by the IC is simply: $350 \times 2.3\text{ m} = 805\text{ mW}$. For design and reliability reasons, it would be interesting to reduce this source of wasted power which increases the die temperature. This can be achieved by using different methods:

1. Use a MOSFET with lower gate charge Q_g
2. Connect pin through a diode (1N4007 typically) to one of the mains input. The average value on pin 8

becomes $\frac{V_{MAINS(peak)} \cdot 2}{\pi}$. Our power

contribution example drops to: $223 \times 2.3\text{ m} = 512\text{ mW}$. If a resistor is installed between the mains and the diode, you further force the dissipation to migrate from the package to the resistor. The resistor value should account for low-line startup.

3. Permanently force the V_{CC} level above V_{CC_H} with an auxiliary winding. It will automatically disconnect the internal startup source and the IC will be fully self-supplied from this winding. Again, the total power drawn from the mains will significantly decrease. Make sure the auxiliary voltage never exceeds the 16 V limit.

NCP1200A

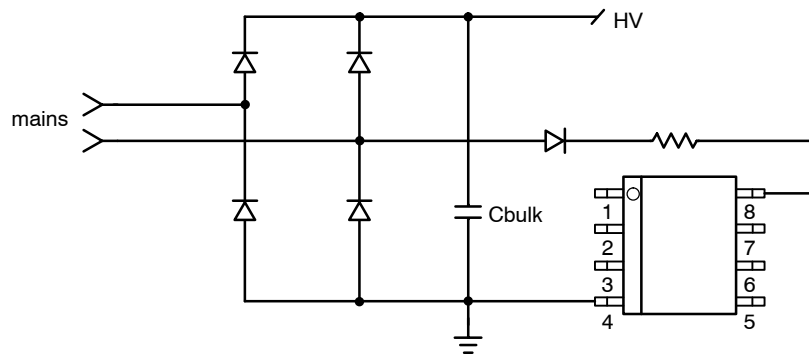

Figure 16. A simple diode naturally reduces the average voltage on pin 8

Skipping Cycle Mode

The NCP1200A automatically skips switching cycles when the output power demand drops below a given level. This is accomplished by monitoring the FB pin. In normal operation, pin 2 imposes a peak current accordingly to the load value. If the load demand decreases, the internal loop asks for less peak current. When this setpoint reaches a determined level, the IC prevents the current from decreasing further down and starts to blank the output pulses: the IC enters the so-called skip cycle mode, also named controlled burst operation. The power transfer now depends upon the width of the pulse bunches (Figure 18). Suppose we have the following component values:

L_p , primary inductance = 1 mH

F_{sw} , switching frequency = 61 kHz

$I_{p \text{ skip}}$ = 200 mA (or $333 \text{ mV}/R_{SENSE}$)

The theoretical power transfer is therefore:

$$\frac{1}{2} \cdot L_p \cdot I_p^2 \cdot F_{sw} = 1.2 \text{ W}$$

If this IC enters skip cycle mode with a bunch length of 20 ms over a recurrent period of 100 ms, then the total power transfer is: $1.2 \cdot 0.2 = 240 \text{ mW}$.

To better understand how this skip cycle mode takes place, a look at the operation mode versus the FB level immediately gives the necessary insight:

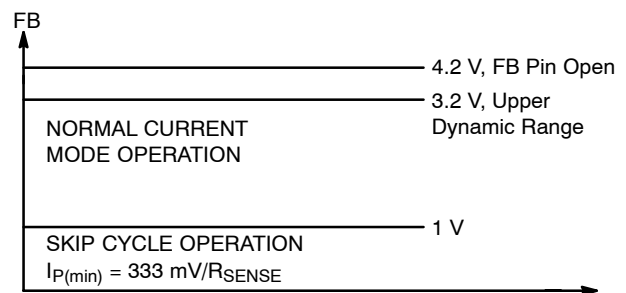

Figure 17.

When FB is above the skip cycle threshold (1 V by default), the peak current cannot exceed $1 \text{ V}/R_{SENSE}$. When the IC enters the skip cycle mode, the peak current cannot go below $V_{pin1} / 3.3$. The user still has the flexibility to alter this 1 V by either shunting pin 1 to ground through a resistor or raising it through a resistor up to the desired level. Grounding pin 1 permanently invalidates the skip cycle operation.

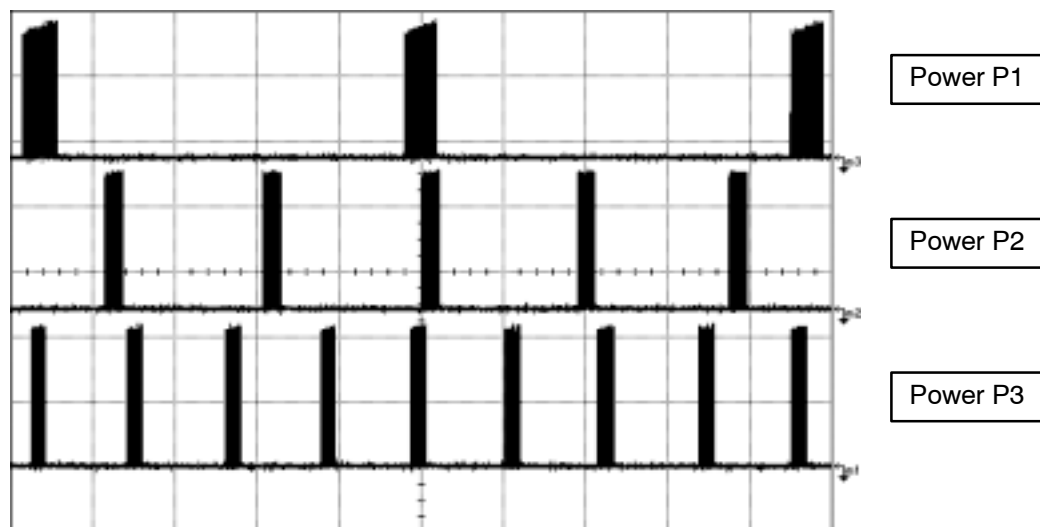

Figure 18. Output Pulses at Various Power Levels ($X = 5.0 \mu\text{s}/\text{div}$) $P1 < P2 < P3$

NCP1200A

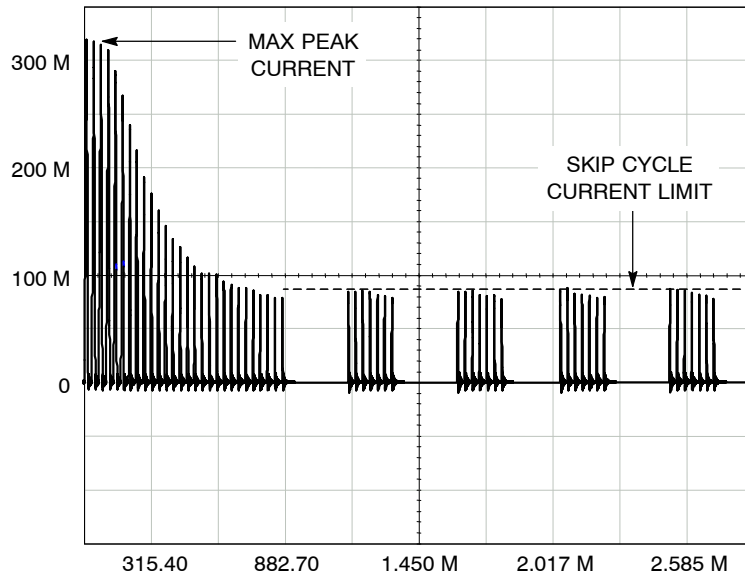

Figure 19. The Skip Cycle Takes Place at Low Peak Currents which Guaranties Noise-Free Operation

We recommend a pin 1 operation between 400 mV and 1.3 V that will fix the skip peak current level between 120 mV / RSENSE and 390 mV / RSENSE.

Non-Latching Shutdown

In some cases, it might be desirable to shut off the part temporarily and authorize its restart once the default has

disappeared. This option can easily be accomplished through a single NPN bipolar transistor wired between FB and ground. By pulling FB below the Adj pin 1 level, the output pulses are disabled as long as FB is pulled below pin 1. As soon as FB is relaxed, the IC resumes its operation. Figure 20 depicts the application example:

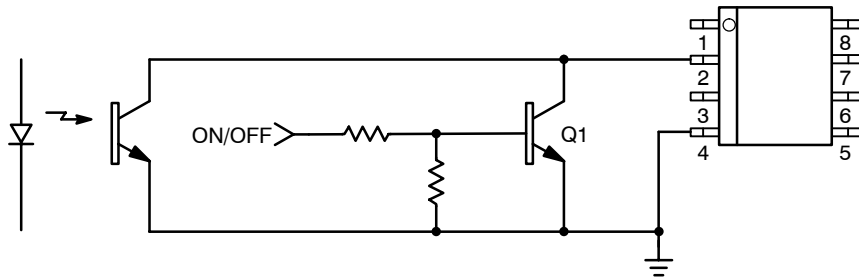

Figure 20. Another Way of Shutting Down the IC without a Definitive Latchoff State

Power Dissipation

The NCP1200A is directly supplied from the DC rail through the internal DSS circuitry. The average current flowing through the DSS is therefore the direct image of the NCP1200A current consumption. The total power dissipation can be evaluated using: $(V_{HVDC} - 11 \text{ V}) \cdot ICC2$. If we operate the device on a 250 VAC rail, the maximum rectified voltage can go up to 350 VDC. However, as the characterization curves show, the current consumption drops at high junction temperature, which quickly occurs due to the DSS operation. At $T_J = 50^\circ\text{C}$, $ICC2 = 1.7 \text{ mA}$ for the 61 kHz version over a 1 nF capacitive load. As a result, the NCP1200A will dissipate $350 \cdot 1.7 \text{ mA}@T_J = 50^\circ\text{C} = 595 \text{ mW}$. The SOIC-8 package offers a junction-to-ambient thermal resistance $R_{\theta JA}$ of 178°C/W . Adding some copper area around the PCB footprint will help decreasing this number: 12 mm x 12 mm to drop $R_{\theta JA}$ down to 100°C/W with 35 μ copper thickness (1 oz.) or 6.5 mm x 6.5 mm with 70 μ copper thickness (2 oz.). With this later number, we can compute the maximum power dissipation the package accepts at an ambient of 50°C :

$$P_{max} = \frac{T_{Jmax} - T_{Amax}}{R_{\theta JA}} = 750 \text{ mW}$$
 which is okay with our previous budget. For the DIP8 package, adding a min-pad area of 80 mm² of 35 μ copper (1 oz.), $R_{\theta JA}$ drops from 100°C/W to about 75°C/W .

In the above calculations, $ICC2$ is based on a 1 nF output capacitor. As seen before, $ICC2$ will depend on your MOSFET's Q_g : $ICC2 \approx ICC1 + F_{SW} \times Q_g$. Final calculation shall thus accounts for the total gate-charge Q_g your MOSFET will exhibit. The same methodology can be applied for the 100 kHz version but care must be taken to keep T_J below the 125°C limit with the D100 (SOIC) version and activated DSS in high-line conditions.

If the power estimation is beyond the limit, other solutions are possible a) add a series diode with pin 8 (as suggested in the above lines) and connect it to the half rectified wave. As a result, it will drop the average input voltage and lower the

dissipation to: $\frac{350 \cdot 2}{\pi} \cdot 1.7 \text{ m} = 380 \text{ mW}$ b) put an auxiliary winding to disable the DSS and decrease the power consumption to $V_{CC} \times ICC2$. The auxiliary level should be thus that the rectified auxiliary voltage permanently stays above 10 V (to not re-activate the DSS) and is safely kept below the 16 V maximum rating.

Overload Operation

In applications where the output current is purposely not controlled (e.g. wall adapters delivering raw DC level), it is interesting to implement a true short-circuit protection. A short-circuit actually forces the output voltage to be at a low level, preventing a bias current to circulate in the optocoupler LED. As a result, the FB pin level is pulled up to 4.2 V, as internally imposed by the IC. The peak current setpoint goes to the maximum and the supply delivers a rather high power with all the associated effects. Please note that this can also happen in case of feedback loss, e.g. a broken optocoupler. To account for this situation, NCP1200A hosts a dedicated overload detection circuitry. Once activated, this circuitry imposes to deliver pulses in a burst manner with a low duty cycle. The system auto-recovers when the fault condition disappears.

During the startup phase, the peak current is pushed to the maximum until the output voltage reaches its target and the feedback loop takes over. This period of time depends on normal output load conditions and the maximum peak current allowed by the system. The time-out used by this IC works with the V_{CC} decoupling capacitor: as soon as the V_{CC} decreases from the $UVLO_H$ level (typically 12 V) the device internally watches for an overload current situation. If this condition is still present when the $UVLO_L$ level is reached, the controller stops the driving pulses, prevents the self-supply current source to restart and puts all the circuitry in standby, consuming as little as 350 μA typical ($ICC3$ parameter). As a result, the V_{CC} level slowly discharges toward 0.

NCP1200A

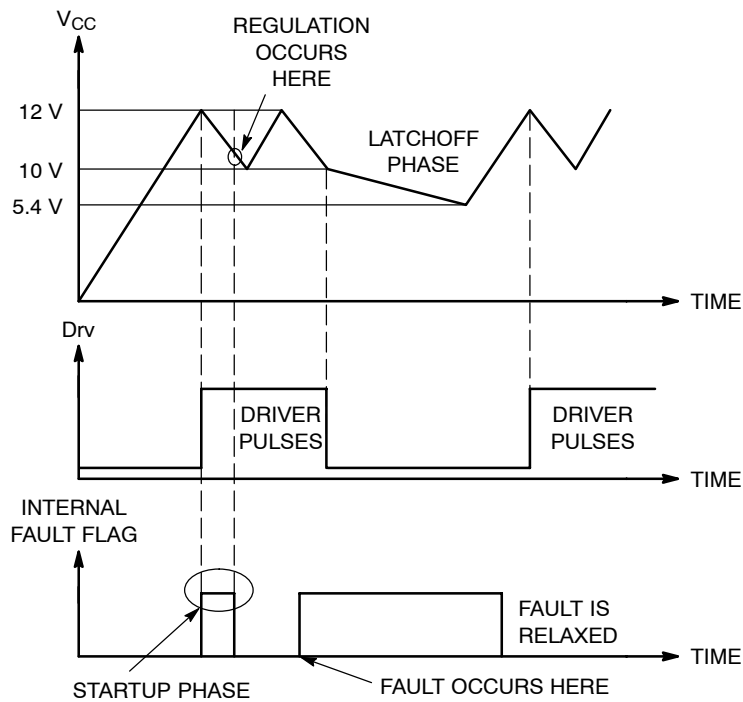

Figure 21. If the fault is relaxed during the V_{CC} natural fall down sequence, the IC automatically resumes. If the fault still persists when V_{CC} reached UVLO_L, then the controller cuts everything off until recovery.

When this level crosses 5.4 V typical, the controller enters a new startup phase by turning the current source on: V_{CC} rises toward 12 V and again delivers output pulses at the UVLO_H crossing point. If the fault condition has been removed before UVLO_L approaches, then the IC continues its normal operation. Otherwise, a new fault cycle takes place. Figure 21 shows the evolution of the signals in presence of a fault.

Calculating the V_{CC} Capacitor

As the above section describes, the fall down sequence depends upon the V_{CC} level: how long does it take for the V_{CC} line to go from 12 V to 10 V? The required time depends on the startup sequence of your system, i.e. when you first apply the power to the IC. The corresponding transient fault duration due to the output capacitor charging must be less than the time needed to discharge from 12 V to 10 V, otherwise the supply will not properly start. The test consists

in either simulating or measuring in the lab how much time the system takes to reach the regulation at full load. Let's suppose that this time corresponds to 6 ms. Therefore a V_{CC} fall time of 10 ms could be well appropriated in order to not trigger the overload detection circuitry. If the corresponding IC consumption, including the MOSFET drive, establishes at 1.8 mA for instance, we can calculate the required

capacitor using the following formula: $\Delta t = \frac{\Delta V \cdot C}{i}$, with $\Delta V = 2$ V. Then for a wanted Δt of 10 ms, C equals 9 μ F or 22 μ F for a standard value. When an overload condition occurs, the IC blocks its internal circuitry and its consumption drops to 350 μ A typical. This happens at V_{CC} = 10 V and it remains stuck until V_{CC} reaches 5.4 V: we are in latching phase. Again, using the calculated 22 μ F and 350 μ A current consumption, this latching phase lasts: 296 ms.

Protecting the Controller Against Negative Spikes and Turn-off Problems

As with any controller built upon a CMOS technology, it is the designer’s duty to avoid the presence of negative spikes on sensitive pins. Negative signals have the bad habit to forward bias the controller substrate and induce erratic behaviors. Sometimes, the injection can be so strong that internal parasitic SCRs are triggered, engendering irremediable damages to the IC if they are a low impedance path is offered between V_{CC} and GND. If the current sense pin is often the seat of such spurious signals, the high-voltage pin can also be the source of problems in certain circumstances. During the turn-off sequence, e.g. when the user unplugs the power supply, the controller is still

fed by its V_{CC} capacitor and keeps activating the MOSFET ON and OFF with a peak current limited by R_{sense} . Unfortunately, if the quality coefficient Q of the resonating network formed by L_p and C_{bulk} is low (e.g. the MOSFET $R_{dson} + R_{sense}$ are small), conditions are met to make the circuit resonate and thus negatively bias the controller. Since we are talking about ms pulses, the amount of injected charge ($Q = I \times t$) immediately latches the controller which brutally discharges its V_{CC} capacitor. If this V_{CC} capacitor is of sufficient value, its stored energy damages the controller. Figure 22 depicts a typical negative shot occurring on the HV pin where the brutal V_{CC} discharge testifies for latchup.

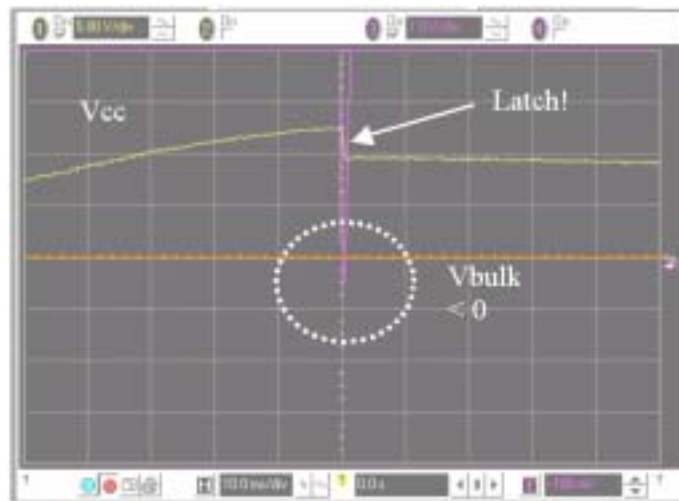

Figure 22. A negative spike takes place on the Bulk capacitor at the switch-off sequence

In low V_{CC} conditions, the NCP1200A gate drive signal show an abnormal behavior and can stay high a few tens of milliseconds. This problem can occur at turn-off but is usually harmless since the bulk capacitor has been discharged by the switching pulses. However, the problem

can become worse if high V_T MOSFETs are implemented. Be sure that the selected MOSFET V_T is between 2.0 V (minimum) and 4.0 V (maximum). Figure 23 shows the typical operating waveforms.

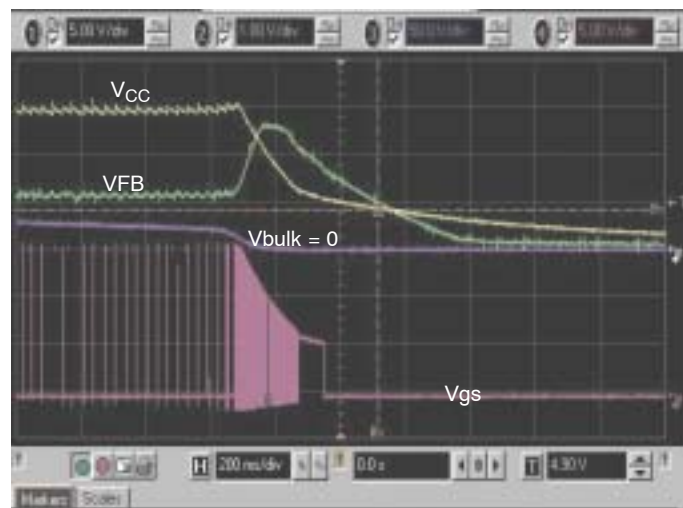

Figure 23. If quick V_{CC} depletion is lacking, the drive output can remain high.

NCP1200A

A simple and inexpensive solution helps circumventing both problems, negative biasing, and gate high transient. It consists in a solution using one 1N4007 (or two in a series for safety) forcing the V_{CC} capacitor to deplete at the same rate as the bulk capacitor does. Figure 24 shows the solution.

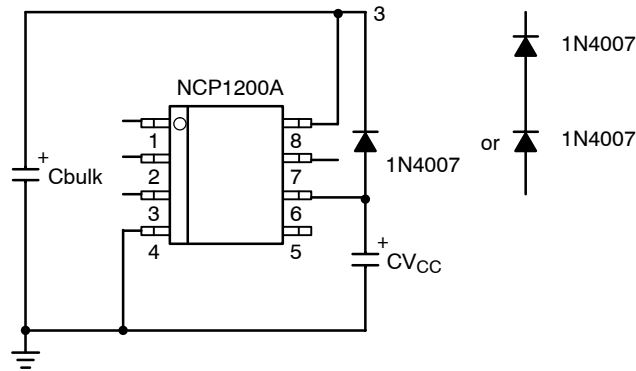

Figure 24. A Diode Forces the V_{CC} Capacitor to Quickly Discharge at Power-off

When the bulk naturally depletes at power-off, the diode brings the V_{CC} down as soon as V_{bulk} drops below V_{CC} . This ensures a clean turn-off and the above problems go away.

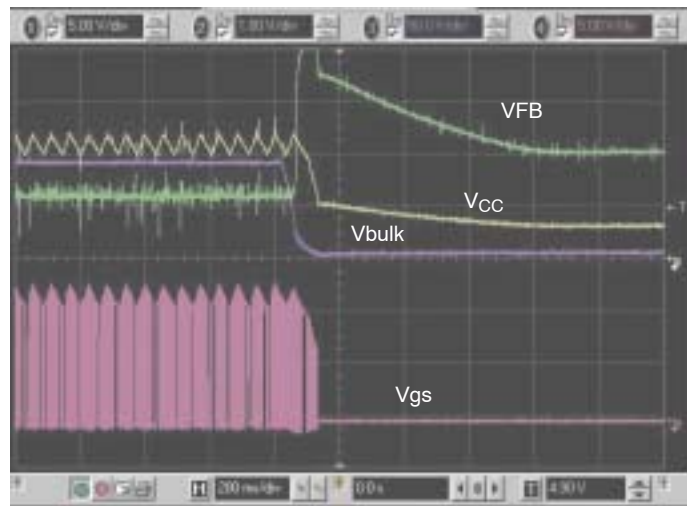

Figure 25. The Diode Addition Forces a Clean Turn-off Sequence both Negative Biasing and Gate High State Troubles

Once implemented, please make sure that your operating waveforms match those of Figure 25. That is to say, a bulk level depleting the V_{CC} capacitor at turn-off. To summarize:

1. Wire a diode between V_{CC} and the bulk capacitor as illustrated by Figure 24.
2. Select a MOSFET affected by a standard V_T , minimum of 2 V, maximum of 4 V.
3. Check that final waveforms match Figure 25 signals

NCP1200A

ORDERING INFORMATION

Device	Type	Marking	Package	Shipping [†]
NCP1200AP40	F _{SW} = 40 kHz	1200AP40	PDIP-8	50 Units / Rail
NCP1200AP40G		1200AP40	PDIP-8 (Pb-Free)	50 Units / Rail
NCP1200AD40R2		200A4	SOIC-8	2500 Units /Reel
NCP1200AP60	F _{SW} = 60 kHz	1200AP60	PDIP-8	50 Units / Rail
NCP1200AP60G		1200AP60	PDIP-8 (Pb-Free)	50 Units / Rail
NCP1200AD60R2		200A6	SOIC-8	2500 Units /Reel
NCP1200AD60R2G		200A6	SOIC-8 (Pb-Free)	2500 Units /Reel
NCP1200AP100	F _{SW} = 100 kHz	1200AP100	PDIP-8	50 Units / Rail
NCP1200AP100G		1200AP100	PDIP-8 (Pb-Free)	50 Units / Rail
NCP1200AD100R2		200A1	SOIC-8	2500 Units / Reel
NCP1200AD100R2G		200A1	SOIC-8 (Pb-Free)	2500 Units / Reel

[†]For information on tape and reel specifications, including part orientation and tape sizes, please refer to our Tape and Reel Packaging Specifications Brochure, BRD8011/D.

NCP1200A

PACKAGE DIMENSIONS

SOIC-8
D SUFFIX
CASE 751-07
ISSUE AD

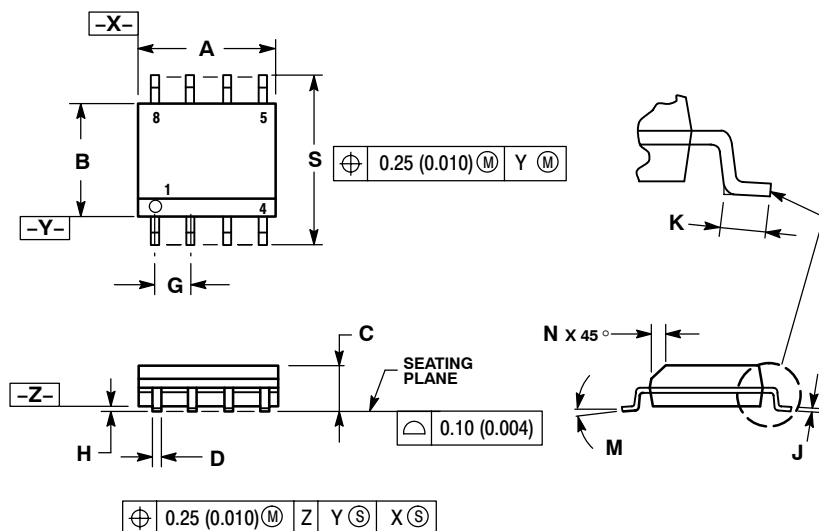

NOTES:

1. DIMENSIONING AND TOLERANCING PER ANSI Y14.5M, 1982.
2. CONTROLLING DIMENSION: MILLIMETER.
3. DIMENSION A AND B DO NOT INCLUDE MOLD PROTRUSION.
4. MAXIMUM MOLD PROTRUSION 0.15 (0.006) PER SIDE.
5. DIMENSION D DOES NOT INCLUDE DAMBAR PROTRUSION. ALLOWABLE DAMBAR PROTRUSION SHALL BE 0.127 (0.005) TOTAL IN EXCESS OF THE D DIMENSION AT MAXIMUM MATERIAL CONDITION.
6. 751-01 THRU 751-06 ARE OBSOLETE. NEW STANDARD IS 751-07.

DIM	MILLIMETERS		INCHES	
	MIN	MAX	MIN	MAX
A	4.80	5.00	0.189	0.197
B	3.80	4.00	0.150	0.157
C	1.35	1.75	0.053	0.069
D	0.33	0.51	0.013	0.020
G	1.27 BSC		0.050 BSC	
H	0.10	0.25	0.004	0.010
J	0.19	0.25	0.007	0.010
K	0.40	1.27	0.016	0.050
M	0°	8°	0°	8°
N	0.25	0.50	0.010	0.020
S	5.80	6.20	0.228	0.244

SOLDERING FOOTPRINT*

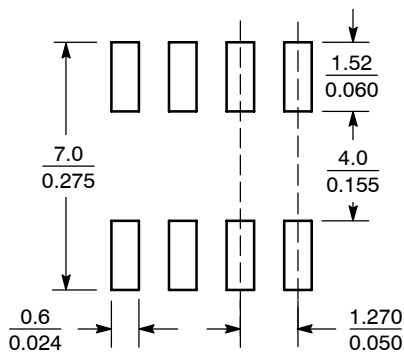

SCALE 6:1 (mm/inches)

*For additional information on our Pb-Free strategy and soldering details, please download the ON Semiconductor Soldering and Mounting Techniques Reference Manual, SOLDERRM/D.

NCP1200A

PACKAGE DIMENSIONS

PDIP-8
P SUFFIX
CASE 626-05
ISSUE L

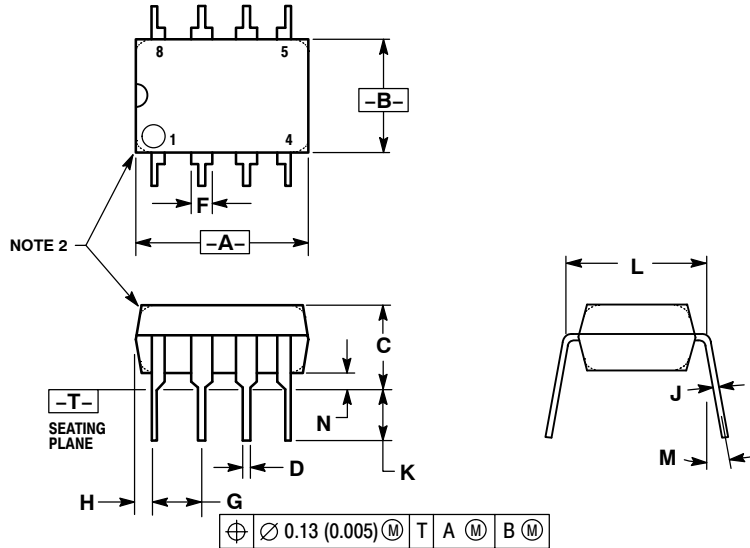

NOTES:

1. DIMENSION L TO CENTER OF LEAD WHEN FORMED PARALLEL.
2. PACKAGE CONTOUR OPTIONAL (ROUND OR SQUARE CORNERS).
3. DIMENSIONING AND TOLERANCING PER ANSI Y14.5M, 1982.

DIM	MILLIMETERS		INCHES	
	MIN	MAX	MIN	MAX
A	9.40	10.16	0.370	0.400
B	6.10	6.60	0.240	0.260
C	3.94	4.45	0.155	0.175
D	0.38	0.51	0.015	0.020
F	1.02	1.78	0.040	0.070
G	2.54 BSC		0.100 BSC	
H	0.76	1.27	0.030	0.050
J	0.20	0.30	0.008	0.012
K	2.92	3.43	0.115	0.135
L	7.62 BSC		0.300 BSC	
M	---	10°	---	10°
N	0.76	1.01	0.030	0.040

The product described herein (NCP1200A), may be covered by the following U.S. patents: 6,271,735, 6,362,067, 6,385,060, 6,429,709, 6,587,357. There may be other patents pending.

ON Semiconductor and  are registered trademarks of Semiconductor Components Industries, LLC (SCILLC). SCILLC reserves the right to make changes without further notice to any products herein. SCILLC makes no warranty, representation or guarantee regarding the suitability of its products for any particular purpose, nor does SCILLC assume any liability arising out of the application or use of any product or circuit, and specifically disclaims any and all liability, including without limitation special, consequential or incidental damages. "Typical" parameters which may be provided in SCILLC data sheets and/or specifications can and do vary in different applications and actual performance may vary over time. All operating parameters, including "Typicals" must be validated for each customer application by customer's technical experts. SCILLC does not convey any license under its patent rights nor the rights of others. SCILLC products are not designed, intended, or authorized for use as components in systems intended for surgical implant into the body, or other applications intended to support or sustain life, or for any other application in which the failure of the SCILLC product could create a situation where personal injury or death may occur. Should Buyer purchase or use SCILLC products for any such unintended or unauthorized application, Buyer shall indemnify and hold SCILLC and its officers, employees, subsidiaries, affiliates, and distributors harmless against all claims, costs, damages, and expenses, and reasonable attorney fees arising out of, directly or indirectly, any claim of personal injury or death associated with such unintended or unauthorized use, even if such claim alleges that SCILLC was negligent regarding the design or manufacture of the part. SCILLC is an Equal Opportunity/Affirmative Action Employer. This literature is subject to all applicable copyright laws and is not for resale in any manner.

PUBLICATION ORDERING INFORMATION

LITERATURE FULFILLMENT:
Literature Distribution Center for ON Semiconductor
P.O. Box 61312, Phoenix, Arizona 85082-1312 USA
Phone: 480-829-7710 or 800-344-3860 Toll Free USA/Canada
Fax: 480-829-7709 or 800-344-3867 Toll Free USA/Canada
Email: orderlit@onsemi.com

N. American Technical Support: 800-282-9855 Toll Free USA/Canada

Japan: ON Semiconductor, Japan Customer Focus Center
2-9-1 Kamimeguro, Meguro-ku, Tokyo, Japan 153-0051
Phone: 81-3-5773-3850



ON Semiconductor Website: <http://onsemi.com>

Order Literature: <http://www.onsemi.com/litorder>

For additional information, please contact your local Sales Representative.

Looking for pricing, stock, or lifecycle information?

Click below to explore more details on WIN SOURCE:

-  [View NCP1200AD100R2 on WIN SOURCE](#)
-  [ON Semiconductor Information](#)

Optimize Your Supply Chain with WIN SOURCE Solutions

-  Global Sourcing Solution
-  Obsolete Management
-  Cost Control Management
-  Shortage Management
-  Alternative Solution
-  Excess Inventory Management