



**THE DATASHEET OF
MX25L12845EMI-10G**



The Ultimate Performance Flash Memory

Macronix Serial Multi I/O(MXSMIO™) Flash

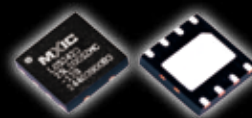

Innovation . Quality . Teamwork . Efficiency . Service



Contents

Why Use MXSMIO™ Family?	3
• Advantages of Macronix Serial Multi-I/O Flash Family	4
• Worldwide NOR Flash Trend	5
• The Fastest Performance Serial Flash on the Market	6
• Move Ahead of the Competition-MXSMIO™ Duplex	7
How to Design with Multi-I/O ?	8
• Hardware Considerations	
• Software Considerations	
• Enhanced Performance	9
• Pin Assignments	9
MXSMIO™ Flash Families	11
• 3V Standard Serial Flash Families	11
• Secure Serial Flash Family	13
• Serial ROM Family	14
• Low Voltage Serial Flash Family	15
Thin & Small Packages	17

Need Fast Speed?
Look to **Macronix**,
the Leader in Serial Flash

Why Use MXSMIO™ Family?

Advantages of Macronix Serial Multi-I/O (MXSMIO™) Flash Family

Today more & more application require **code execution** & **fast download** functionality in their systems design. The Macronix Serial MXSMIO Flash products are available in Dual & Quad I/O capability to meet these system requirements. These products offer many advantages, such as:

- Read performance comparable to Parallel Flash
- Shorter system boot-up time
- Layout simplification
- Less cross-talk wires
- Lower power consumption
- Reduced pin-count (Controller or ASIC chip)
- Reduce RAM buffer size for code execution (direct access from Serial Flash)
- Lower system BOM cost

Applications Using Multi I/O Serial Flash

MXSMIO Flash Family, ranging from 16Mb~128Mb, are already supported by leading chipset companies for a variety of applications including:

- Optical Disk Drive
- Digital TV
- DVD Player
- Wireless LAN
- Printer
- Camera module
- Keyboard Controller

And several diverse applications will use this new generation "MXSMIO™ Flash Family" as their mainstream NOR Flash such as UWB , GE-PON, PLC, DSL & Set-Top Boxes, high speed servers, PC motherboards, Notebooks, graphic cards, HDDs, electronic dictionary, modems, and etc.

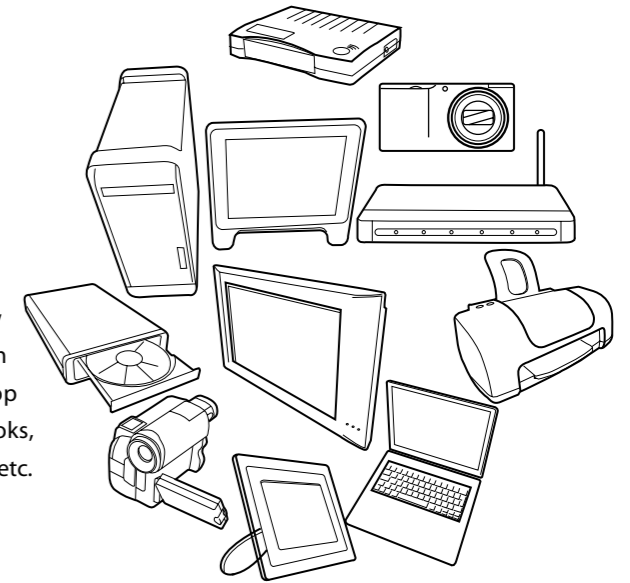



MXSMIO™

- Faster Than a Speeding Bullet

Catch the WorldWide Flash Trend:

Parallel → Serial → Multi-I/O Serial Flash

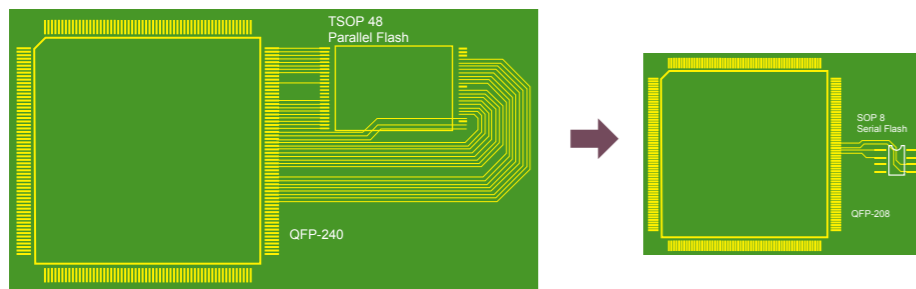

Serial Flash memories are rapidly taking over the code storage market from Parallel Flash in the same densities. The diagram above clearly indicates the benefits of moving to a Serial Flash device. With a parallel interconnect there are 38 external connections with 16 data bus and 19 address bus lines, whereas the SPI bus interface has only 4 interconnect signals. Not only is the layout simplified, the interface of the SPI bus reduces the size of the control chip as well. For example, in the ODD application, the controller size is reduced from a QFP240 to a QFP208 pin package and the routing based on this reduction not only reduces the size of the printed circuit board, but also reduces EMI and cross-talk.

Despite the reduction in pin count and the cost advantage of the smaller package, the new MXSMIO™ Flash family also provides outstanding access time, even better than Parallel Flash, which enables designers to use Serial Flash in speed critical applications.

Fastest Read Speed - Outperforming Parallel Flash

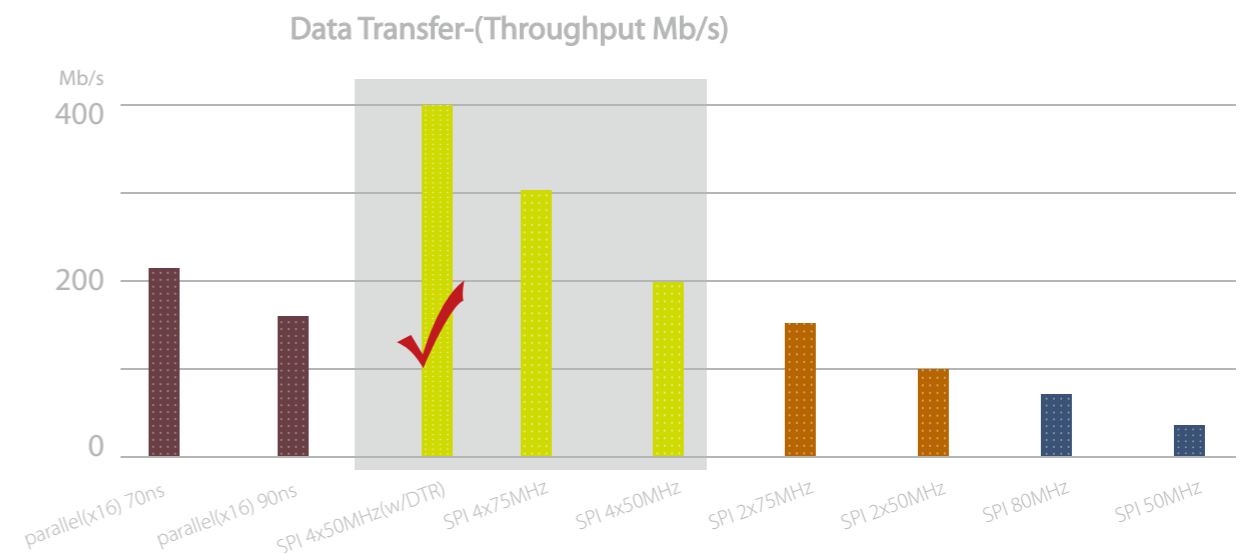

Leading Edge Breakthrough: Macronix is the leading Serial Flash supplier in the industry with largest market share (Web-Feet Research, March 2009). In 2009 Macronix continues to demonstrate its leadership in the Serial Flash market by offering the fastest products in the industry - MXSMIO™ Duplex Family - Quad I/O with Double Transfer Rate(DTR) mode with speeds up to 400MHz .

The above diagram clearly demonstrates the Quad I/O DTR Serial Flash (MXSMIO™ Duplex) can exceed the performance of Parallel Flash. Our customers are already migrating from Parallel to Serial Flash.

Even without DTR, the Macronix Quad I/O Serial Flash provides amazing performance approaching DRAM speeds of 300Mb/s, and even exceeding the 220 Mb/s speed mark of a fast 70ns, 16bit Parallel NOR-Flash .

Move Ahead of the Competition – Double Transfer Rate Serial Flash(MXSMIO™ Duplex)

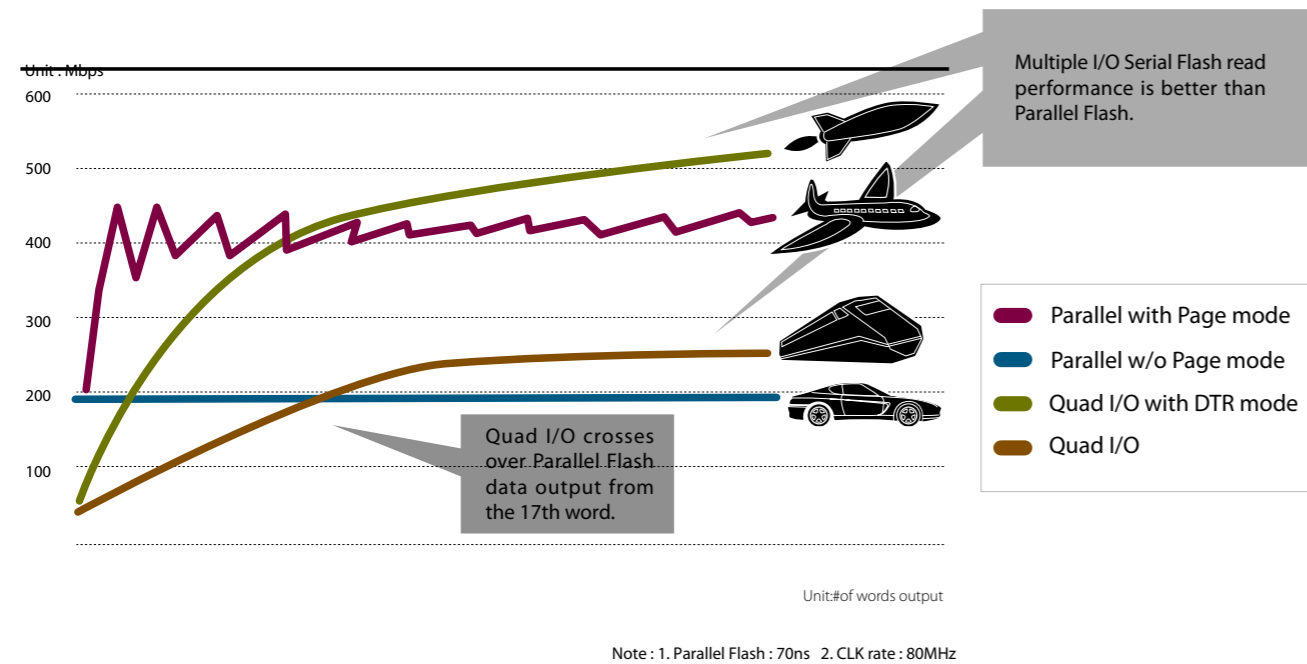

Key Features:

- Quad I/O with Double Transfer Rate Serial Flash has
 - Quad I/O
 - > Four I/O signals instead of one I/O signal
 - Double Transfer Rate(DTR)
 - > Signals triggered on both rising and falling edge of clock
- Faster transfer of data from Serial Flash to DRAM or other chips
- No changes to hardware-command code based operation
- Backward compatible to Single/Dual/Quad I/O
- Wide voltage range of 2.7V to 3.6V
- Temperature range of -40°C to +85°C
- Fastest clock speed in the industry for serial flash
 - 104MHz for fast read mode
 - 400MHz for Quad I/O DTR operations
- 8-pin/16-pin SOP (SOIC) and 8-pin WSON (thin) Packages
 - 16-pin SOP (SOIC) package support
 - 16-pin SOP and KGD options.
 - 8 pins for parallel mode programming to speed up production programming

How to Design with Multi- I/O Works?

Hardware Considerations

Both Dual and Quad I/O Serial Flash from Macronix maintain backward compatibility - occupying exactly the same footprint used by conventional Single I/O Flash in 8-pin SOP packages. In other words, there is no need to modify the PCB or change the socket.

Software Considerations

The device identification should be properly specified to distinguish the traditional Single I/O Serial Flash from the new Multi-I/O ones. The following chart shows the command sets for customers using these devices in their systems. The recommended flow is to do READ ID check first : then to do DTR Quad I/O ID check, to Quad I/O ID check, and then Dual I/O ID and at last to do Single I/O ID check. If the IDs are all correct, it means that the device will support the abovementioned functions.

Command Sets for Serial Flash Family

	Action	Command
READ Command	READ	03 Hex
	FAST READ	QB Hex
	Dual I/O READ	BB Hex
	Quad I/O READ	EB Hex
	Quad I/O DTR READ	ED Hex
PROGRAM Command	Quad I/O PAGE PROGRAM	38 Hex
READ ID	REMS4D(READ ID for Quad I/O DDR Mode)	CF Hex
	REMS4(READ ID for Quad I/O Mode)	DF Hex
	REMS2(READ ID for Dual I/O Mode)	EF Hex
	REMS(READ ID for Single I/O Mode)	90 Hex

Multi I/O Serial Flash memories of the same density have the same device ID and are backward compatible to single I/O products. Applications currently using Single I/O mode can migrate to Multi I/O in the future, since the device IDs are the same. The software will need to be updated to address the Multi I/O commands.

Enhanced Performance

An added feature in the Multi-I/O DTR Serial Flash offers Enhanced Performance by saving 36 clock cycles compared to the Single I/O Flash. This further upgrades performance of the device. This feature eliminates the need to repeat the 8 cycles used for commands when successive operations are performed using the same command with random addresses. This feature advises the device that the current command is to be repeated during the next operation. If this current operation is a Multi-I/O read command, the Flash will be kept in the Multi-I/O Read Mode and the next read operation can be initiated by simply supplying a new address and the required number of dummy cycles.

Pin Assignments

Serial Flash Pin Assignment (8-Pin Package)

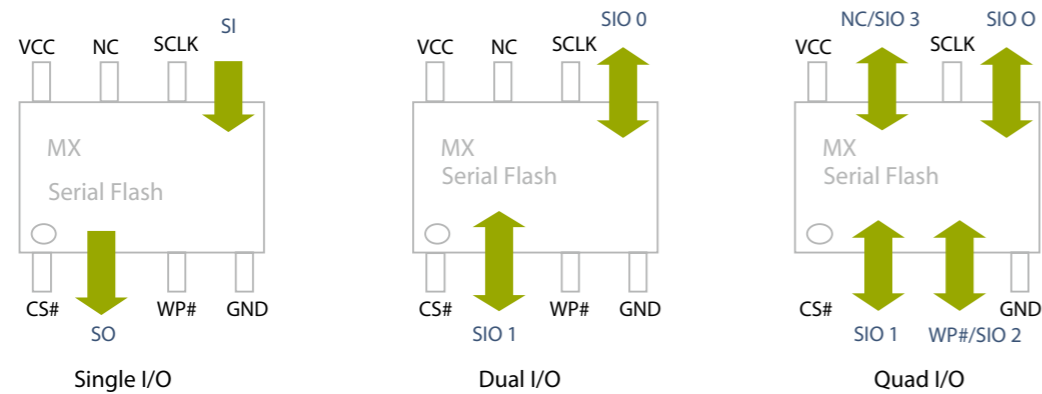

The Macronix Multi-I/O Serial Flash doubles or even quadruples the data rate by changing the conventional Serial Input pin and Serial Out pin from single unidirectional data flow into multiple bi-directional data flows. The Dual I/O version uses SI and SO pins for both serial input and output, while the Quad I/O version uses SI and SO pins along with Write Protect pin and NC pin for both data input and output Functions. This doubling or quadrupling of data rate allows Serial Flash to compete with Parallel Flash for data read performance.



MXSMIO™ Flash Families

3V Standard Serial Flash Families

MXSMIO™ Family includes high performance Serial Flash products with Dual I/O(MX25xx05) and Quad I/O(MX25xx35/45) operations which double and quadruple the read performance of systems for high-end consumer applications. Multiple I/O products range from 16Mb to 128Mb, while Single I/O products are provided from 512Kb to 128Mb densities. These products are offered in 4KB sectors and 64KB blocks and this architecture makes these products compatible to Serial Flash from other suppliers' architecture in the industry. Moreover, the Dual I/O and Quad I/O parts are backward compatible to the Single I/O versions which make them very convenient to use.

Key Features:

- Fast read performance :

- Dual I/O - 150MHz read (4-dummy cycles)
- Quad I/O - 300MHz read (6-dummy cycles)
- Quad I/O DTR - 400MHz read (6-dummy cycles)

Serial Flash products offer new security options for diverse customer needs: (Dual, Quad I/O option)

- √Flexible write protection
- √Secure OTP
- √Additional special protection



Single I/O 3V Family:

Part number	Density	Voltage	Clock Speed (MHz)	I/O bus	Package	Mass Production
MX25L512C	512kb	2.7~3.6V	85	Single	8-SOP, 8-USON(2x3mm)	Y
MX25L1005C	1Mb	2.7~3.6V	85	Single	8-SOP, 8-USON(2x3mm)	Y
MX25L2005C	2Mb	2.7~3.6V	85	Single	8-SOP, 8-WSON(6x5mm)	Y
MX25L4005C	4Mb	2.7~3.6V	85	Single	8-SOP, 8-USON(4x4mm) 8-WSON(6x5mm)	Y
MX25L8005	8Mb	2.7~3.6V	86	Single	8-SOP, 8-PDIP, 8-WSON(6x5mm), 8-USON(4x4mm)	Y
MX25L1605D	16Mb	2.7~3.6V	86	Single	8-SOP, 8-PDIP, 16-SOP 8-WSON(6x5mm), 8-USON(4x4mm)	Y
MX25L3205D	32Mb	2.7~3.6V	86	Single	8-SOP, 8-PDIP, 16-SOP, 8-WSON(6x5mm) 8-USON(4x4mm)	Y
MX25L6405D	64Mb	2.7~3.6V	86	Single	16-SOP,8-WSON(6x8mm)	Y*
MX25L12805D	128Mb	2.7~3.6V	50	Single	16-SOP	Y*

Note : Y* Not recommended for new designs

Dual I/O 3V Family:

Part number	Density	Voltage	Clock Speed (MHz)	I/O bus	Package	Mass Production
MX25L1605D	16Mb	2.7~3.6V	86 / 100	Single / Dual	8-SOP, 8-PDIP, 16-SOP 8-WSON(6x5mm), 8-USON(4x4mm)	Y
MX25L3205D	32Mb	2.7~3.6V	86 / 100	Single / Dual	8-SOP, 8-PDIP, 16-SOP, 8-WSON(6x5mm) 8-USON(4x4mm)	Y
MX25L6405D	64Mb	2.7~3.6V	86 / 100	Single / Dual	16-SOP,8-WSON(6x8mm)	Y*

Note : Y* Not recommended for new designs

Quad I/O 3V Family:

Part number	Density	Voltage	Clock Speed (MHz)	I/O bus	Package	Mass Production
MX25L1635D	16Mb	2.7~3.6V	104/150/300	Single / Dual / Quad	8-SOP, 16-SOP, 8-WSON(6x5mm)	Y
MX25L3235D	32Mb	2.7~3.6V	104/150/300	Single / Dual / Quad	8-SOP, 16-SOP, 8-WSON(6x5mm)	Y
MX25L6445E	64Mb	2.7~3.6V	104/140/280/400	Single / Dual / Quad / DTR	8-SOP, 16-SOP, 8-WSON(6x8mm)	Y
MX25L12845E	128Mb	2.7~3.6V	104/140/280/400	Single / Dual / Quad / DTR	16-SOP	Y

Secure Serial Flash

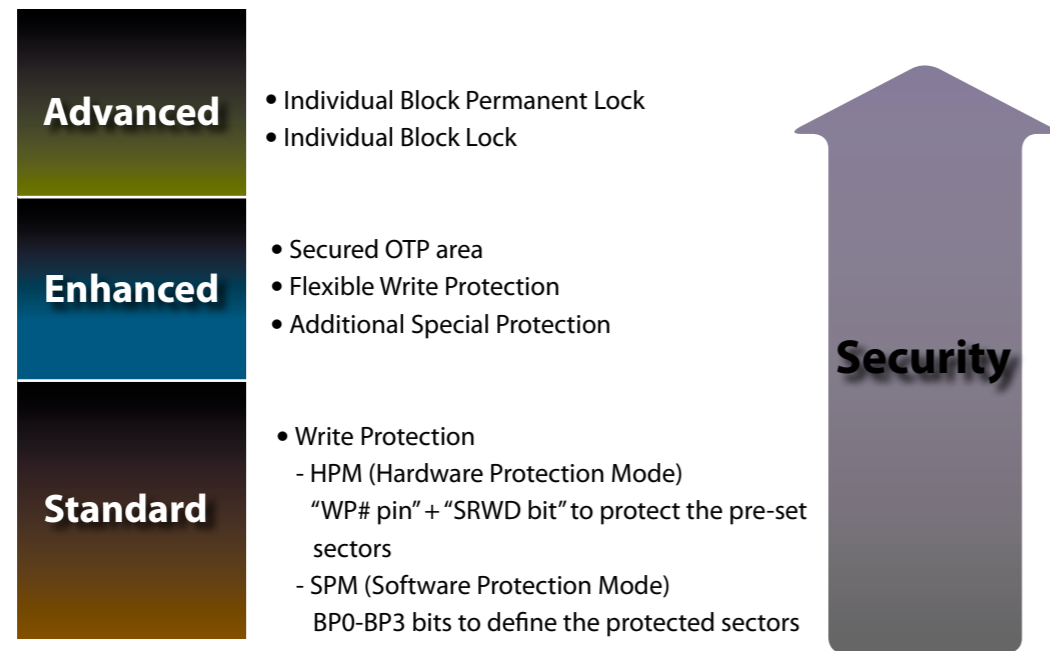

Macronix Security Features

Modern electronic systems are susceptible to unauthorized or accidental alteration of code and data. Non-volatile memory such as Mask-ROM or NOR flash contains critical information that could be altered or cloned. Systems manufacturers require innovative ways to secure their intellectual property and investment. New versions of Macronix Serial Flash are available as Secure Flash, offering various means of write protection (OTP and Temporary/Permanent Lock) and read protection within certain parts of the memory.

Secure 3V Flash

Part number	Density	Organization	Clock Speed (MHz)	I/O Bus	Package
MX25L1655D	16Mb	16M x 1/ 8M x 2/ 4M x 4	104/150/300	Single / Dual / Quad	8-SOP, 24 BGA(6x8mm)
MX25L3255D	32Mb	32M x 1/ 16M x 2/ 8M x 4	104/150/300	Single / Dual / Quad	8-SOP, 24 BGA(6x8mm)
MX25L6455E	64Mb	64M x 1/ 32M x 2	104/140/280/400	Single / Dual / Quad / DTR	16-SOP, 24 BGA(6x8mm)
MX25L12855E	128Mb	128M x 1/ 64M x 2 32M x 4	104/140/280/400	Single / Dual / Quad / DTR	16-SOP, 24 BGA(10x13mm)

Serial ROM Family

For fixed software code applications like Printers, Game consoles, Toys, etc. Macronix provides a high performance as well as cost effective Serial ROM Family of products.

Featuring the same read performance as MXSMIO™ Family, yet taking advantage of low-cost OTP process technology, the Serial ROM Family products range from 16Mb to 128Mb and above with Dual and Quad I/O read capability with the same memory sector and block structure as MXSMIO™ Flash family.

Key Features:

- Fast read performance :
 - Dual I/O - 50MHz read (4-dummy cycles)
 - Quad I/O - 75MHz read (6-dummy cycles)

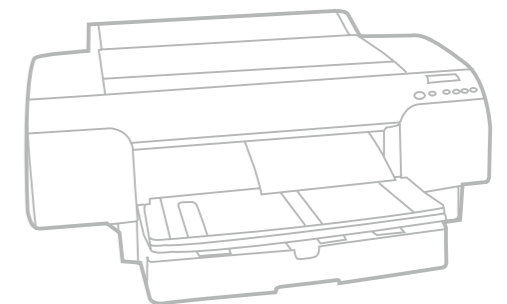

Serial ROM Family

Part number	Density	Voltage	Clock Speed (MHz)	I/O bus	Package	Mass Production
MX23L1635D	16Mb	2.7~3.6V	104 / 50 / 75	Single / Dual / Quad	8-SOP	TBD
MX23L3235D	32Mb	2.7~3.6V	104 / 50 / 75	Single / Dual / Quad	8-SOP	TBD
MX23L6445E	64Mb	2.7~3.6V	100 / 140 / 280 / 400	Single / Dual / Quad / DTR	8-SOP	TBD
MX23L12845E	128Mb	2.7~3.6V	100 / 140 / 280 / 400	Single / Dual / Quad / DTR	16-SOP	TBD

Low Voltage Serial Multi-I/O Flash

For low power consumption devices such as GPS, Bluetooth, HDD and cordless phones, Macronix offers 25U(1.8V) series and 25V(2.5V) series components enabling system designer to design for tight power budgets. By lowering the operating voltage and reducing operating current, Macronix Flash provides low power consumption which makes it a truly ideal product for battery-powered portable applications.



1.8V /2.5V Serial Flash- Major Specifications

VCC range

- 1.65V to 2.0V; -40°C to 85°C
- 2.35V to 3.6V or 2.25V to 2.75V; -40°C to 85°C

Density

- 4Mb, 8Mb, 16Mb, 32Mb

Fastest clock speed in the industry for 1.8V serial flash

- 25MHz (Normal read mode)
- 40MHz (Fast read mode)
- 80/132 MHz (Dual/Quad I/O read mode)

Low standby current

- Standby current 1uA(typ.), 5uA(max.) (resume time: 30μs)

Interface

- Standard Serial Peripheral Interface (SPI)
- Multi-I/O -- Dual, Quad Input/Output

Command

- Industry standard commands for basic operations
- Enhanced commands for Macronix proprietary features

Hardware pins

- CS#, SCLK, SIO0, SIO1, WP#/SIO2, SIO3

2.5V Family

Part Number	Density	Organization	Clock Speed (MHz)	I/O bus	Package	Mass Production
25V4005C	4Mb	x 1	50MHz	Single	8-SOP, 8-WSON(6x5mm)	Q32009
25V4035	4Mb	x 1 / x 2 / x 4	66/100/200	Single/Dual/Quad	8-SOP, 8-WSON(6x5mm)	Q32009
25V8005	8Mb	x 1	50MHz	Single	8-SOP, 8-WSON	Y
25V8035	8Mb	x 1 / x 2 / x 4	66/100/200	Single/Dual/Quad	8-SOP, 8-WSON(6x5mm)	Q32009

1.8V Family

Part Number	Density	Organization	Clock Speed (MHz)	I/O bus	Package	Mass Production
25U4035	4Mb	4M x 1/ 2M x 2/ 1M x 4	40/80/132	Single/Dual/Quad	8-SOP, 8USON(4x4mm)	Y
25U8035	8Mb	8M x 1/ 4M x 2/ 2M x 4	40/80/132	Single/Dual/Quad	8-SOP, 8USON(4x4mm)	Y
25U1635E	16Mb	16M x 1/ 8M x 2/ 4M x 4	104/168/336	Single/Dual/Quad	8-SOP, 8-USON(4x4mm)	2010
25U3235E	32Mb	32M x 1/ 16M x 2/ 8M x 4	104/168/336	Single/Dual/Quad	8-SOP, 8-WSON(6x5mm)	2010

PCB Space a Problem? Macronix Has the Perfect Solution

Thin & Small Packages

Macronix provides Flash products with small form-factor packages, for space-constrained applications. Apart from industry standard packages, Known Good Die(KGD) solutions for System in Package(SiP) applications are also available.

	512Kb	1Mb	2Mb	4Mb	8Mb	16Mb	32Mb	64Mb
8-SOP(150 mil)	●	●	●	●	●	●		
8-SOP(200 mil)				●	●	●	●	●
8-WSON(0.8mm height)			6x5	6x5	6x5	6x5	6x5	8x6
8-USON(0.6mm height)	2x3	2x3		4x4	4x4	4x4	4x4	

Multiple Package Options

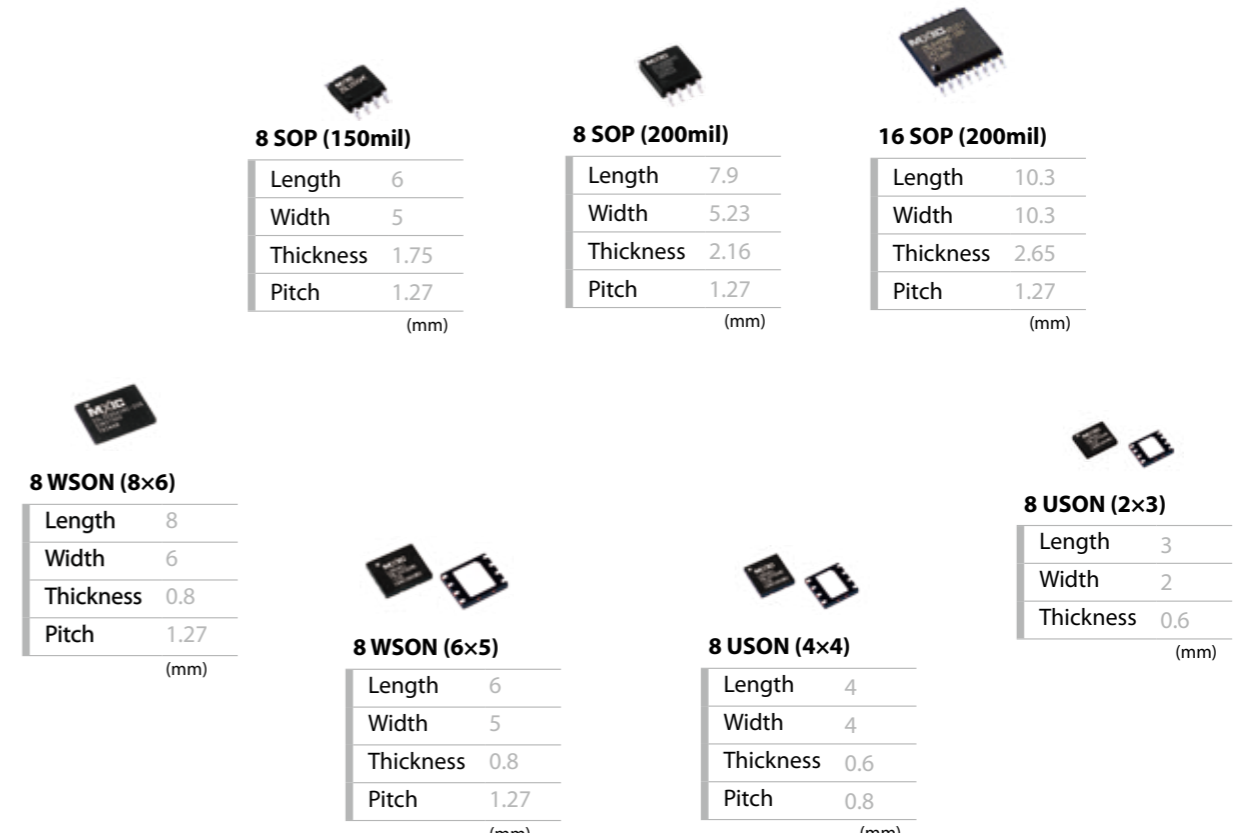

8 SOP (150mil)		8 SOP (200mil)		16 SOP (200mil)	
Length	6	Length	7.9	Length	10.3
Width	5	Width	5.23	Width	10.3
Thickness	1.75	Thickness	2.16	Thickness	2.65
Pitch	1.27 (mm)	Pitch	1.27 (mm)	Pitch	1.27 (mm)

8 WSON (8x6)		8 WSON (6x5)		8 USON (4x4)		8 USON (2x3)	
Length	8	Length	6	Length	4	Length	3
Width	6	Width	5	Width	4	Width	2
Thickness	0.8	Thickness	0.8	Thickness	0.6	Thickness	0.6
Pitch	1.27 (mm)	Pitch	1.27 (mm)	Pitch	0.8 (mm)	Pitch	0.6 (mm)



**MACRONIX
INTERNATIONAL Co., LTD.**

Headquarters

Macronix International Co., Ltd.

16, Li-Hsin Road, Science Park, Hsinchu, Taiwan
Tel: +886-3-578-6688
Fax: +886-3-563-2888

Taipei

Macronix International Co., Ltd.

19F, 4, Min-Chuan E. Road, Sec. 3, Taipei, Taiwan
Tel: +886-2-2509-3300
Fax: +886-2-2509-2200

China - SuZhou

Macronix (Hong Kong) Co., Limited, SuZhou Office

No.5, XingHai Rd, SuZhou Industrial Park,
SuZhou China 215021
Tel: +86-512-6258-0888
Fax: +86-512-6258-6799

China - ShenZhen

Macronix (Hong Kong) Co., Limited, ShenZhen Office

Room 1401, Block A Tian An Hi-Tech Plaza Tower
CheGongMiao Futian District Shenzhen 518040 PRC
Tel: +86-755-8343-3579
Fax: +86-755-8343-8078

China - Hong Kong

Macronix (Hong Kong) Co., Ltd.

702-703, 7/F, Building 9, Hong Kong Science Park,
5 Science Park West Avenue, Sha Tin, N.T.
Tel: +852-2607-4289
Fax: +852-2607-4229

Singapore

Macronix Pte. Ltd.

1 Marine Parade Central #11-03 Parkway Centre Singapore 449408
Tel: +65-6346-5505
Fax: +65-6348-8096

Japan

Macronix Asia Limited.

NKF Bldg. 5F, 1-2 Higashida-cho,
Kawasaki-ku Kawasaki-shi, Kanagawa Pref. 210-0005, Japan
Tel: +81-44-246-9100
Fax: +81-44-246-9105

Korea

Macronix Asia Limited.

#906, 9F, Kangnam Bldg., 1321-4, Seocho-Dong, Seocho-Ku,
135-070, Seoul, Korea
Tel: +82-2-588-6887
Fax: +82-2-588-6828

America

Macronix America, Inc.

680 North McCarthy Blvd. Milpitas, CA 95035, U.S.A.
Tel: +1-408-262-8887
Fax: +1-408-262-8810

Europe

Macronix Europe N.V.

Koningin Astridlaan 59, Bus 1 1780 Wemmel Belgium
Tel: +32-2-456-8020
Fax: +32-2-456-8021

About Macronix International Co., Ltd.

Founded in 1989, Macronix International Co., Ltd. (TSE: 2337.TT) is a leading provider of innovative non-volatile memory (NVM) solutions. Macronix is the largest worldwide manufacturer of ROM products, and also provides a wide range of NOR Flash products across various densities. These are used in embedded systems, consumer, communication and enterprise applications.

For more information, please visit the Company website at www.macronix.com.

Copyright © Macronix International Co., Ltd. 2009. All Rights Reserved. Macronix, MXIC, MXIC logo, MXSMIO, XtraROM, NBit and Macronix NBit are trademarks or registered trademark of Macronix International Co., Ltd.. The names and brands of other companies are for identification purposes only and may be claimed as the property of the respective companies.

Looking for pricing, stock, or lifecycle information?

Click below to explore more details on WIN SOURCE:

- ⊖ [View MX25L12845EMI-10G on WIN SOURCE](#)
- ⊖ [Macronix Information](#)

Optimize Your Supply Chain with WIN SOURCE Solutions

- ✓ Global Sourcing Solution
- ✓ Obsolete Management
- ✓ Cost Control Management
- ✓ Shortage Management
- ✓ Alternative Solution
- ✓ Excess Inventory Management