



**THE DATASHEET OF  
MSA-0986-TR1G**



# MSA-0986

## Cascadable Silicon Bipolar MMIC Amplifier



### Data Sheet

#### Description

The MSA-0986 is a high performance silicon bipolar Monolithic Microwave Integrated Circuit (MMIC) housed in a low cost, surface mount plastic package. This MMIC is designed for very wide bandwidth industrial and commercial applications that require flat gain and low VSWR.

The MSA-series is fabricated using Avago's 10 GHz  $f_T$ , 25 GHz  $f_{MAX}$ , silicon bipolar MMIC process which uses nitride self-alignment, ion implantation, and gold metallization to achieve excellent performance, uniformity and reliability. The use of an external bias resistor for temperature and current stability also allows bias flexibility.

#### Features

- Broadband, Minimum Ripple Cascadable 50 $\Omega$  Gain Block
- $7.2 \pm 0.5$  dB Typical Gain Flatness from 0.1 to 3.0 GHz
- 3 dB Bandwidth: 0.1 to 5.5 GHz
- 10.5 dBm Typical  $P_{1dB}$  at 2.0 GHz
- Surface Mount Plastic Package
- Tape-and-Reel Packaging Option Available
- Lead-free Option Available

#### 86 Plastic Package

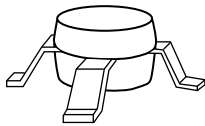

#### Typical Biasing Configuration

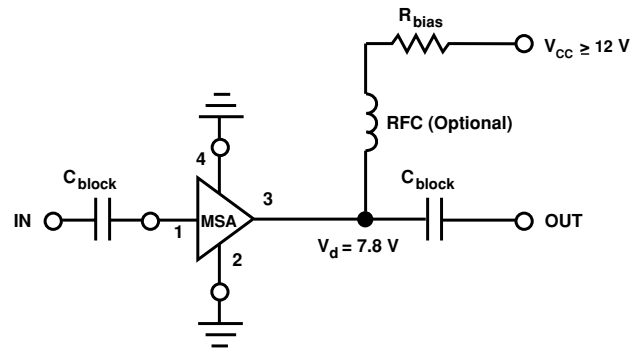

### MSA-0986 Absolute Maximum Ratings

Parameter	Absolute Maximum <sup>[1]</sup>
Device Current	65 mA
Power Dissipation <sup>[2,3]</sup>	500 mW
RF Input Power	+13 dBm
Junction Temperature	150°C
Storage Temperature	-65 to +150°C

### Thermal Resistance<sup>[2]:</sup>

$$\theta_{jc} = 140^{\circ}\text{C/W}$$

#### Notes:

1. Permanent damage may occur if any of these limits are exceeded.
2.  $T_{\text{CASE}} = 25^{\circ}\text{C}$ .
3. Derate at 7.1 mW/°C for  $T_{\text{C}} > 80^{\circ}\text{C}$ .

### Electrical Specifications<sup>[1]</sup>, $T_{\text{A}} = 25^{\circ}\text{C}$

Symbol	Parameters and Test Conditions: $I_{\text{d}} = 35 \text{ mA}$ , $Z_{\text{o}} = 50 \Omega$	Units	Min.	Typ.	Max.
$G_{\text{P}}$	Power Gain ( $ S_{21} ^2$ ) $f = 2.0 \text{ GHz}$	dB	6.0	7.2	
$\Delta G_{\text{P}}$	Gain Flatness $f = 0.1 \text{ to } 3.0 \text{ GHz}$	dB		$\pm 0.5$	
$f_{3 \text{ dB}}$	3 dB Bandwidth <sup>[2]</sup>	GHz		5.5	
VSWR	Input VSWR $f = 1.0 \text{ to } 3.0 \text{ GHz}$			1.6:1	
	Output VSWR $f = 1.0 \text{ to } 3.0 \text{ GHz}$			1.8:1	
NF	50 $\Omega$ Noise Figure $f = 2.0 \text{ GHz}$	dB		6.2	
$P_{1 \text{ dB}}$	Output Power at 1 dB Gain Compression $f = 2.0 \text{ GHz}$	dBm		10.5	
$\text{IP}_3$	Third Order Intercept Point $f = 2.0 \text{ GHz}$	dBm		23.0	
$t_{\text{D}}$	Group Delay $f = 2.0 \text{ GHz}$	psec		95	
$V_{\text{d}}$	Device Voltage	V	6.2	7.8	9.4
dV/dT	Device Voltage Temperature Coefficient	mV/°C		-16.0	

#### Notes:

1. The recommended operating current range for this device is 25 to 45 mA. Typical performance as a function of current is on the following page.
2. Referenced from 0.1 GHz gain ( $G_{\text{P}}$ ).

### Ordering Information

Part Numbers	No. of Devices	Comments
MSA-0986-BLK	100	Bulk
MSA-0986-BLKG	100	Bulk
MSA-0986-TR1	1000	7" Reel
MSA-0986-TR1G	1000	7" Reel
MSA-0986-TR2	4000	13" Reel
MSA-0986-TR2G	4000	13" Reel

**Note:** Order part number with a "G" suffix if lead-free option is desired.

**MSA-0986 Typical Scattering Parameters ( $Z_0 = 50 \Omega$ ,  $T_A = 25^\circ\text{C}$ ,  $I_d = 35 \text{ mA}$ )**

Freq. GHz	$S_{11}$		$S_{21}$			$S_{12}$			$S_{22}$		k
	Mag	Ang	dB	Mag	Ang	dB	Mag	Ang	Mag	Ang	
0.02	.36	-105	11.4	3.72	145	-14.1	.198	18	.38	-102	0.73
0.05	.24	-145	8.5	2.65	156	-13.7	.205	5	.25	-143	1.08
0.1	.22	-164	7.7	2.43	166	-13.5	.211	4	.22	-158	1.17
0.2	.21	-179	7.5	2.37	167	-13.5	.212	1	.22	-172	1.20
0.4	.21	165	7.4	2.34	162	-13.4	.214	-1	.22	179	1.20
0.6	.22	155	7.4	2.33	156	-13.5	.212	-2	.22	175	1.21
0.8	.22	145	7.3	2.33	149	-13.4	.213	-2	.23	171	1.21
1.0	.23	136	7.3	2.32	142	-13.4	.214	-4	.24	167	1.20
1.5	.24	118	7.2	2.30	125	-13.3	.217	-6	.26	157	1.19
2.0	.25	106	7.2	2.28	109	-13.0	.224	-10	.28	148	1.16
2.5	.26	100	7.2	2.29	94	-13.0	.224	-12	.33	139	1.15
3.0	.26	94	7.1	2.26	77	-13.0	.224	-15	.34	128	1.15
3.5	.26	95	7.0	2.23	60	-12.8	.229	-21	.36	116	1.14
4.0	.28	96	6.7	2.17	43	-13.1	.221	-25	.35	104	1.18
4.5	.31	100	6.5	2.10	26	-13.6	.210	-31	.32	94	1.23
5.0	.37	101	6.0	2.00	9	-14.2	.196	-35	.26	86	1.30
5.5	.44	97	5.4	1.86	-7	-14.9	.181	-38	.19	88	1.38
6.0	.51	94	4.6	1.69	-22	-15.8	.162	-37	.14	107	1.47

**Typical Performance,  $T_A = 25^\circ\text{C}$** 

(unless otherwise noted)

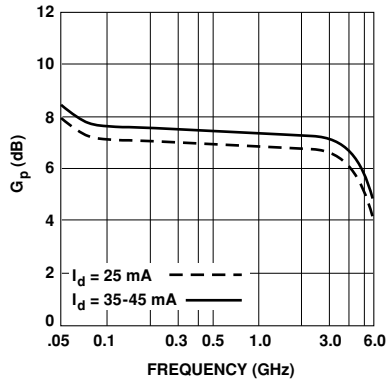
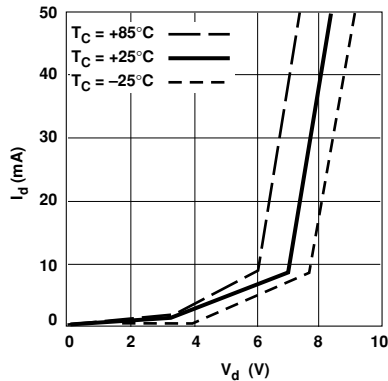
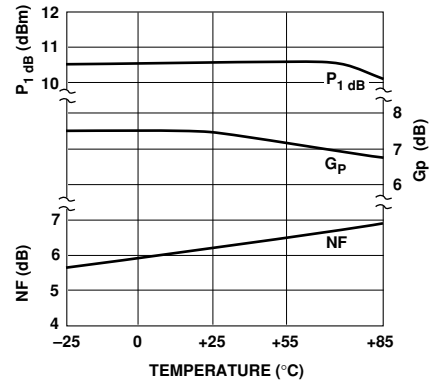
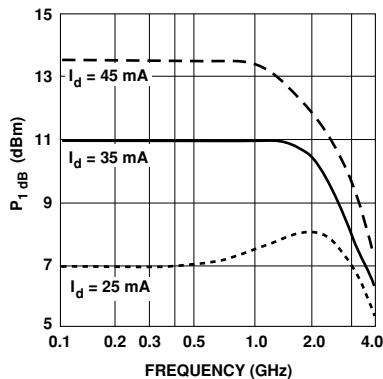
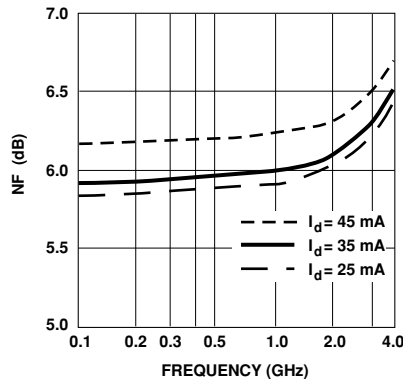
**Figure 1. Typical Power Gain vs. Frequency.**

**Figure 2. Device Current vs. Voltage.**

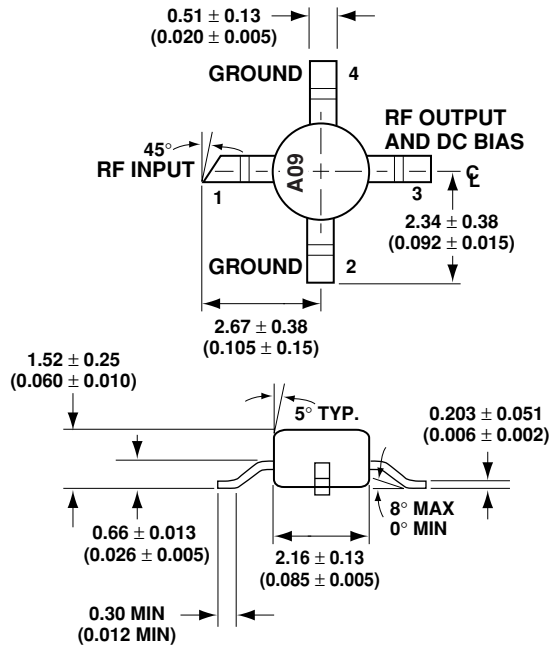
**Figure 3. Output Power at 1 dB Gain Compression, Noise Figure and Power Gain vs. Case Temperature,  $f = 2.0 \text{ GHz}$ ,  $I_d = 35 \text{ mA}$ .**

**Figure 4. Output Power at 1 dB Gain Compression vs. Frequency.**

**Figure 5. Noise Figure vs. Frequency.**

## 86 Plastic Package Dimensions



DIMENSIONS ARE IN MILLIMETERS (INCHES)



For product information and a complete list of distributors, please go to our web site:  
[www.avagotech.com](http://www.avagotech.com)

Avago, Avago Technologies, and the A logo are trademarks of Avago Technologies, Limited in the United States and other countries.  
 Data subject to change. Copyright © 2006 Avago Technologies, Limited. All rights reserved.  
 Obsoletes 5965-9552EN  
 5989-2745EN September 16, 2006

**AVAGO**  
 TECHNOLOGIES

## Looking for pricing, stock, or lifecycle information?

Click below to explore more details on WIN SOURCE:

-  [View MSA-0986-TR1G on WIN SOURCE](#)
-  [Broadcom Limited Information](#)

## Optimize Your Supply Chain with WIN SOURCE Solutions

-  Global Sourcing Solution
-  Obsolete Management
-  Cost Control Management
-  Shortage Management
-  Alternative Solution
-  Excess Inventory Management