



**THE DATASHEET OF
MSA-0836-TR1**



MSA-0836

Cascadable Silicon Bipolar MMIC Amplifier



Data Sheet

Description

The MSA-0836 is a high performance silicon bipolar Monolithic Microwave Integrated Circuit (MMIC) housed in a cost effective, microstrip package. This MMIC is designed for use as a general purpose 50Ω gain block above 0.5 GHz and can be used as a high gain transistor below this frequency. Typical applications include narrow and moderate band IF and RF amplifiers in commercial and industrial applications.

The MSA-series is fabricated using Avago's 10 GHz f_T , 25 GHz f_{MAX} , silicon bipolar MMIC process which uses nitride self-alignment, ion implantation, and gold metallization to achieve excellent performance, uniformity and reliability. The use of an external bias resistor for temperature and current stability also allows bias flexibility.

Features

- Usable Gain to 6.0 GHz
- High Gain:
 - 32.5 dB Typical at 0.1 GHz
 - 23.0 dB Typical at 1.0 GHz
- Low Noise Figure: 3.0 dB Typical at 1.0 GHz
- Cost Effective Ceramic Microstrip Package

36 micro-X Package

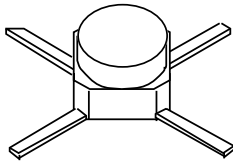

Typical Biasing Configuration

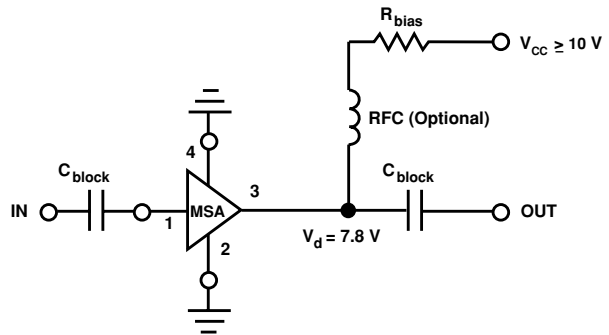

MSA-0836 Absolute Maximum Ratings

| Parameter | Absolute Maximum ^[1] |
|------------------------------------|---------------------------------|
| Device Current | 80 mA |
| Power Dissipation ^[2,3] | 750 mW |
| RF Input Power | +13 dBm |
| Junction Temperature | 150°C |
| Storage Temperature ^[4] | -65°C to 150°C |

Thermal Resistance^{[2,5]:}

$$\theta_{jc} = 175^{\circ}\text{C/W}$$

Notes:

1. Permanent damage may occur if any of these limits are exceeded.
2. $T_{\text{CASE}} = 25^{\circ}\text{C}$.
3. Derate at 5.7 mW/°C for $T_{\text{C}} > 69^{\circ}\text{C}$.
4. Storage above +150°C may tarnish the leads of this package making it difficult to solder into a circuit.
5. The small spot size of this technique results in a higher, though more accurate determination of θ_{jc} than do alternate methods.

Electrical Specifications^[1], $T_{\text{A}} = 25^{\circ}\text{C}$

| Symbol | Parameters and Test Conditions: $I_{\text{d}} = 36 \text{ mA}$, $Z_{\text{o}} = 50 \Omega$ | Units | Min. | Typ. | Max. |
|--------------------|---|---------------------------------------|------|-------|------|
| G_{P} | Power Gain ($ S_{21} ^2$) | $f = 0.1 \text{ GHz}$ | | 32.5 | |
| | | $f = 1.0 \text{ GHz}$ | 22.0 | 23.0 | 25.0 |
| | | $f = 4.0 \text{ GHz}$ | | 10.5 | |
| VSWR | Input VSWR | $f = 1.0 \text{ to } 3.0 \text{ GHz}$ | | 2.0:1 | |
| | Output VSWR | $f = 1.0 \text{ to } 3.0 \text{ GHz}$ | | 1.5:1 | |
| NF | 50 Ω Noise Figure | $f = 1.0 \text{ GHz}$ | | 3.0 | |
| $P_{1 \text{ dB}}$ | Output Power at 1 dB Gain Compression | $f = 1.0 \text{ GHz}$ | | 12.5 | |
| IP_3 | Third Order Intercept Point | $f = 1.0 \text{ GHz}$ | | 27.0 | |
| t_{D} | Group Delay | $f = 1.0 \text{ GHz}$ | | 125 | |
| V_{d} | Device Voltage | V | 7.0 | 7.8 | 8.4 |
| dV/dT | Device Voltage Temperature Coefficient | mV/°C | | -17.0 | |

Note:

1. The recommended operating current range for this device is 20 to 40 mA. Typical performance as a function of current is on the following page.

Ordering Information

| Part Numbers | No. of Devices | Comments |
|---------------|----------------|----------|
| MSA-0836-BLKG | 100 | Bulk |
| MSA-0836-TR1G | 1000 | 7" Reel |

MSA-0836 Typical Scattering Parameters^[1] ($Z_0 = 50 \Omega$, $T_A = 25^\circ\text{C}$, $I_d = 36 \text{ mA}$)

| Freq. GHz | S_{11} | | S_{21} | | | S_{12} | | | S_{22} | | k |
|--------------|----------|------|----------|-------|-----|----------|------|-----|----------|------|------|
| | Mag | Ang | dB | Mag | Ang | dB | Mag | Ang | Mag | Ang | |
| 0.1 | .63 | -17 | 32.5 | 42.02 | 161 | -37.7 | .013 | 55 | .63 | -19 | 0.72 |
| 0.2 | .58 | -33 | 31.5 | 37.52 | 145 | -33.7 | .021 | 47 | .56 | -37 | 0.73 |
| 0.4 | .49 | -56 | 29.1 | 28.50 | 119 | -29.7 | .033 | 54 | .42 | -66 | 0.72 |
| 0.6 | .40 | -70 | 26.7 | 21.54 | 103 | -27.9 | .040 | 55 | .32 | -84 | 0.78 |
| 0.8 | .35 | -80 | 24.6 | 17.01 | 92 | -26.0 | .050 | 53 | .24 | -98 | 0.85 |
| 1.0 | .33 | -89 | 22.9 | 13.98 | 82 | -24.9 | .057 | 52 | .18 | -107 | 0.89 |
| 1.5 | .30 | -111 | 19.5 | 9.45 | 64 | -22.1 | .079 | 51 | .09 | -126 | 0.95 |
| 2.0 | .30 | -133 | 16.9 | 7.03 | 48 | -20.2 | .098 | 44 | .07 | -141 | 0.99 |
| 2.5 | .32 | -150 | 14.9 | 5.53 | 39 | -19.2 | .110 | 42 | .06 | -166 | 1.04 |
| 3.0 | .34 | -170 | 13.2 | 4.56 | 26 | -18.3 | .122 | 36 | .06 | -106 | 1.06 |
| 3.5 | .38 | 175 | 11.7 | 3.86 | 14 | -17.5 | .133 | 32 | .08 | -100 | 1.08 |
| 4.0 | .39 | 162 | 10.5 | 3.33 | 2 | -16.7 | .146 | 27 | .12 | -101 | 1.08 |
| 5.0 | .41 | 132 | 7.9 | 2.47 | -21 | -15.6 | .165 | 19 | .21 | -113 | 1.10 |
| 6.0 | .52 | 95 | 5.8 | 1.94 | -45 | -14.6 | .187 | 7 | .20 | -149 | 1.05 |

Typical Performance, $T_A = 25^\circ\text{C}$

(unless otherwise noted)

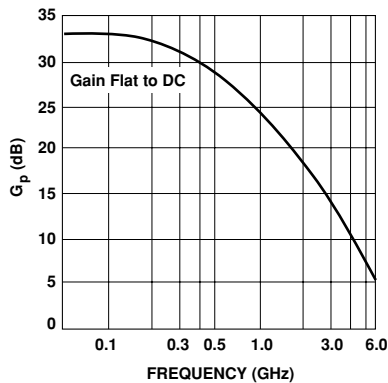
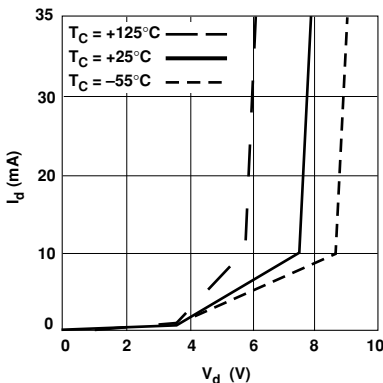
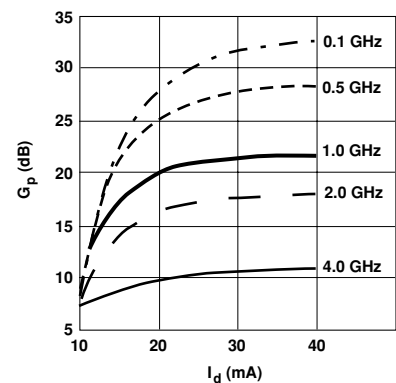
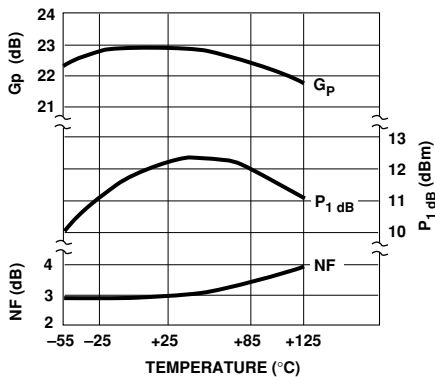
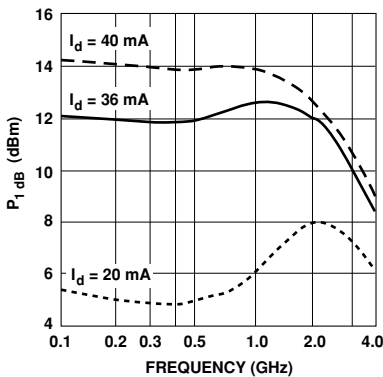
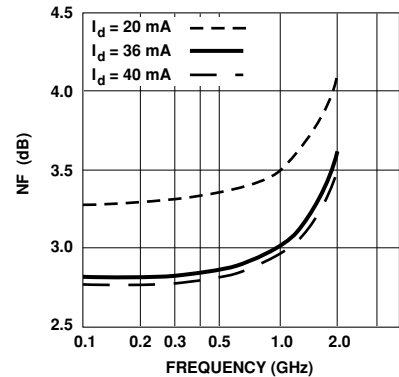
Figure 1. Typical Power Gain vs. Frequency, $I_d = 36 \text{ mA}$.

Figure 2. Device Current vs. Voltage.

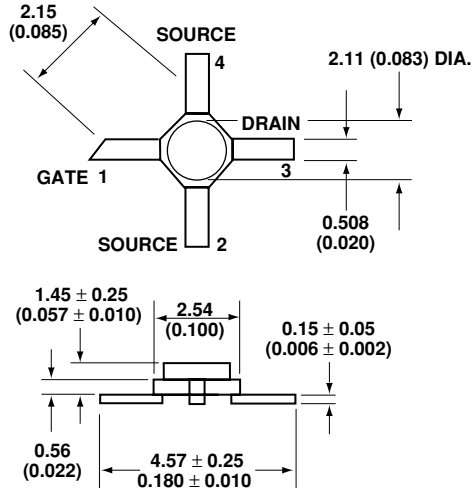
Figure 3. Power Gain vs. Current.

Figure 4. Output Power at 1 dB Gain Compression, NF and Power Gain vs. Case Temperature, $f = 1.0 \text{ GHz}$, $I_d = 36 \text{ mA}$.

Figure 5. Output Power at 1 dB Gain Compression vs. Frequency.

Figure 6. Noise Figure vs. Frequency.

36 micro-X Package Dimensions



Notes:

1. Dimensions are in millimeters (inches)
2. Tolerances: in .xxx = ± 0.005
mm .xx = ± 0.13

For product information and a complete list of distributors, please go to our web site: www.avagotech.com

Avago, Avago Technologies, and the A logo are trademarks of Avago Technologies, Limited in the United States and other countries. Data subject to change. Copyright © 2007 Avago Technologies, Limited. All rights reserved. Obsoletes 5989-2742EN AV02-0306EN - April 12, 2007



Looking for pricing, stock, or lifecycle information?

Click below to explore more details on WIN SOURCE:

 [View MSA-0836-TR1 on WIN SOURCE](#)

 [Broadcom Limited Information](#)

Optimize Your Supply Chain with WIN SOURCE Solutions

-  Global Sourcing Solution
-  Obsolete Management
-  Cost Control Management
-  Shortage Management
-  Alternative Solution
-  Excess Inventory Management