



**THE DATASHEET OF  
MSA-0836-BLKG**



# MSA-0836

## Cascadable Silicon Bipolar MMIC Amplifier



### Data Sheet

#### Description

The MSA-0836 is a high performance silicon bipolar Monolithic Microwave Integrated Circuit (MMIC) housed in a cost effective, microstrip package. This MMIC is designed for use as a general purpose 50Ω gain block above 0.5 GHz and can be used as a high gain transistor below this frequency. Typical applications include narrow and moderate band IF and RF amplifiers in commercial and industrial applications.

The MSA-series is fabricated using Avago's 10 GHz  $f_T$ , 25 GHz  $f_{MAX}$ , silicon bipolar MMIC process which uses nitride self-alignment, ion implantation, and gold metallization to achieve excellent performance, uniformity and reliability. The use of an external bias resistor for temperature and current stability also allows bias flexibility.

#### Features

- Usable Gain to 6.0 GHz
- High Gain:
  - 32.5 dB Typical at 0.1 GHz
  - 23.0 dB Typical at 1.0 GHz
- Low Noise Figure: 3.0 dB Typical at 1.0 GHz
- Cost Effective Ceramic Microstrip Package

#### 36 micro-X Package

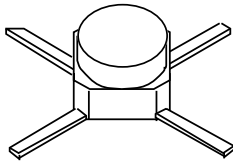

#### Typical Biasing Configuration

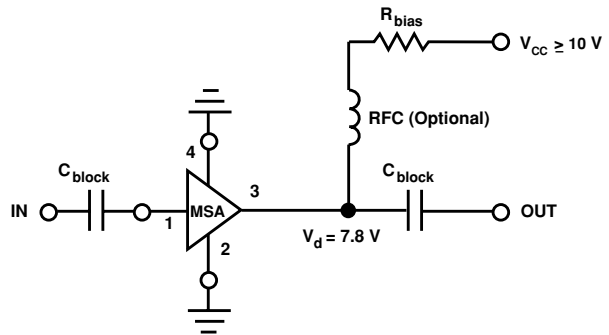

### MSA-0836 Absolute Maximum Ratings

Parameter	Absolute Maximum <sup>[1]</sup>
Device Current	80 mA
Power Dissipation <sup>[2,3]</sup>	750 mW
RF Input Power	+13 dBm
Junction Temperature	150°C
Storage Temperature <sup>[4]</sup>	-65°C to 150°C

### Thermal Resistance<sup>[2,5]:</sup>

$$\theta_{jc} = 175^{\circ}\text{C/W}$$

#### Notes:

1. Permanent damage may occur if any of these limits are exceeded.
2.  $T_{\text{CASE}} = 25^{\circ}\text{C}$ .
3. Derate at 5.7 mW/°C for  $T_{\text{C}} > 69^{\circ}\text{C}$ .
4. Storage above +150°C may tarnish the leads of this package making it difficult to solder into a circuit.
5. The small spot size of this technique results in a higher, though more accurate determination of  $\theta_{jc}$  than do alternate methods.

### Electrical Specifications<sup>[1]</sup>, $T_{\text{A}} = 25^{\circ}\text{C}$

Symbol	Parameters and Test Conditions: $I_{\text{d}} = 36 \text{ mA}$ , $Z_{\text{o}} = 50 \Omega$	Units	Min.	Typ.	Max.
$G_{\text{P}}$	Power Gain ( $ S_{21} ^2$ )	$f = 0.1 \text{ GHz}$		32.5	
		$f = 1.0 \text{ GHz}$	22.0	23.0	25.0
		$f = 4.0 \text{ GHz}$		10.5	
VSWR	Input VSWR	$f = 1.0 \text{ to } 3.0 \text{ GHz}$		2.0:1	
	Output VSWR	$f = 1.0 \text{ to } 3.0 \text{ GHz}$		1.5:1	
NF	50 $\Omega$ Noise Figure	$f = 1.0 \text{ GHz}$		3.0	
$P_{1 \text{ dB}}$	Output Power at 1 dB Gain Compression	$f = 1.0 \text{ GHz}$		12.5	
$\text{IP}_3$	Third Order Intercept Point	$f = 1.0 \text{ GHz}$		27.0	
$t_{\text{D}}$	Group Delay	$f = 1.0 \text{ GHz}$		125	
$V_{\text{d}}$	Device Voltage		7.0	7.8	8.4
$\text{dV/dT}$	Device Voltage Temperature Coefficient			-17.0	

#### Note:

1. The recommended operating current range for this device is 20 to 40 mA. Typical performance as a function of current is on the following page.

### Ordering Information

Part Numbers	No. of Devices	Comments
MSA-0836-BLKG	100	Bulk
MSA-0836-TR1G	1000	7" Reel

**MSA-0836 Typical Scattering Parameters<sup>[1]</sup> ( $Z_0 = 50 \Omega$ ,  $T_A = 25^\circ\text{C}$ ,  $I_d = 36 \text{ mA}$ )**

Freq. GHz	$S_{11}$		$S_{21}$			$S_{12}$			$S_{22}$		k
	Mag	Ang	dB	Mag	Ang	dB	Mag	Ang	Mag	Ang	
0.1	.63	-17	32.5	42.02	161	-37.7	.013	55	.63	-19	0.72
0.2	.58	-33	31.5	37.52	145	-33.7	.021	47	.56	-37	0.73
0.4	.49	-56	29.1	28.50	119	-29.7	.033	54	.42	-66	0.72
0.6	.40	-70	26.7	21.54	103	-27.9	.040	55	.32	-84	0.78
0.8	.35	-80	24.6	17.01	92	-26.0	.050	53	.24	-98	0.85
1.0	.33	-89	22.9	13.98	82	-24.9	.057	52	.18	-107	0.89
1.5	.30	-111	19.5	9.45	64	-22.1	.079	51	.09	-126	0.95
2.0	.30	-133	16.9	7.03	48	-20.2	.098	44	.07	-141	0.99
2.5	.32	-150	14.9	5.53	39	-19.2	.110	42	.06	-166	1.04
3.0	.34	-170	13.2	4.56	26	-18.3	.122	36	.06	-106	1.06
3.5	.38	175	11.7	3.86	14	-17.5	.133	32	.08	-100	1.08
4.0	.39	162	10.5	3.33	2	-16.7	.146	27	.12	-101	1.08
5.0	.41	132	7.9	2.47	-21	-15.6	.165	19	.21	-113	1.10
6.0	.52	95	5.8	1.94	-45	-14.6	.187	7	.20	-149	1.05

**Typical Performance,  $T_A = 25^\circ\text{C}$** 

(unless otherwise noted)

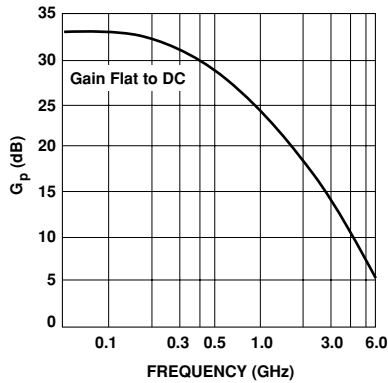
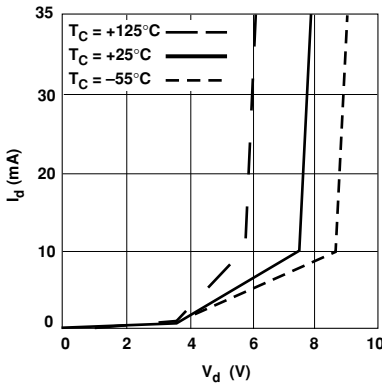
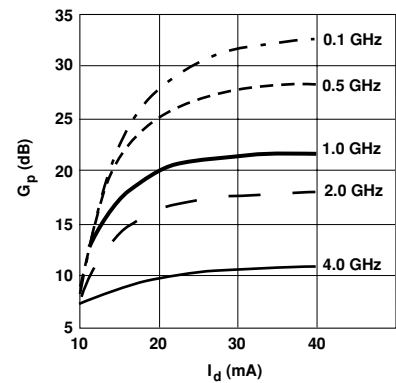
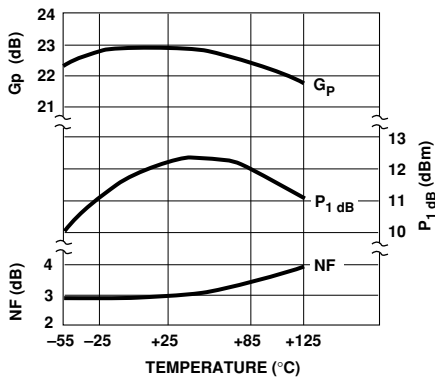
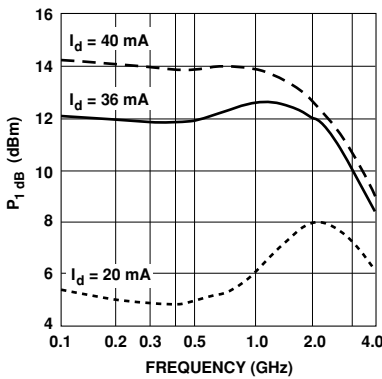
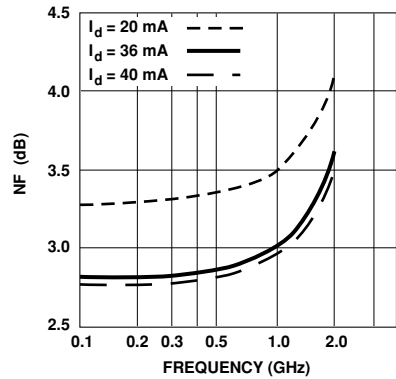
**Figure 1. Typical Power Gain vs. Frequency,  $I_d = 36 \text{ mA}$ .**

**Figure 2. Device Current vs. Voltage.**

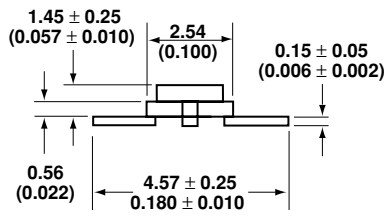
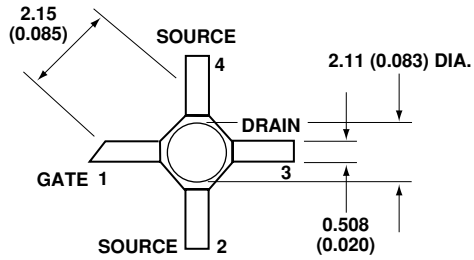
**Figure 3. Power Gain vs. Current.**

**Figure 4. Output Power at 1 dB Gain Compression, NF and Power Gain vs. Case Temperature,  $f = 1.0 \text{ GHz}$ ,  $I_d = 36 \text{ mA}$ .**

**Figure 5. Output Power at 1 dB Gain Compression vs. Frequency.**

**Figure 6. Noise Figure vs. Frequency.**

## 36 micro-X Package Dimensions



### Notes:

1. Dimensions are in millimeters (inches)
2. Tolerances: in .xxx = ± 0.005  
mm .xx = ± 0.13



For product information and a complete list of distributors, please go to our web site: [www.avagotech.com](http://www.avagotech.com)

Avago, Avago Technologies, and the A logo are trademarks of Avago Technologies, Limited in the United States and other countries. Data subject to change. Copyright © 2007 Avago Technologies, Limited. All rights reserved. Obsoletes 5989-2742EN AV02-0306EN - April 12, 2007

**AVAGO**  
TECHNOLOGIES

## Looking for pricing, stock, or lifecycle information?

Click below to explore more details on WIN SOURCE:

-  [View MSA-0836-BLKG on WIN SOURCE](#)
-  [Broadcom Limited Information](#)

## Optimize Your Supply Chain with WIN SOURCE Solutions

-  Global Sourcing Solution
-  Obsolete Management
-  Cost Control Management
-  Shortage Management
-  Alternative Solution
-  Excess Inventory Management