



**THE DATASHEET OF  
MSA-0686-TR1G**



# MSA-0686

## Cascadable Silicon Bipolar MMIC Amplifier



### Data Sheet

#### Description

The MSA-0686 is a high performance silicon bipolar Monolithic Microwave Integrated Circuit (MMIC) housed in a low cost, surface mount plastic package. This MMIC is designed for use as a general purpose 50Ω gain block. Applications include narrow and broad band IF and RF amplifiers in commercial and industrial applications.

The MSA-series is fabricated using Avago's 10 GHz  $f_T$ , 25 GHz  $f_{MAX}$ , silicon bipolar MMIC process which uses nitride self-alignment, ion implantation, and gold metallization to achieve excellent performance, uniformity and reliability. The use of an external bias resistor for temperature and current stability also allows bias flexibility.

#### Features

- Cascadable 50Ω Gain Block
- Low Operating Voltage: 3.5 V Typical  $V_d$
- 3 dB Bandwidth: DC to 0.8 GHz
- High Gain: 18.5 dB Typical at 0.5 GHz
- Low Noise Figure: 3.0 dB Typical at 0.5 GHz
- Surface Mount Plastic Package
- Tape-and-Reel Packaging Available
- Lead-free Option Available

#### 86 Plastic Package

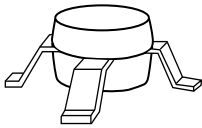

#### Typical Biasing Configuration

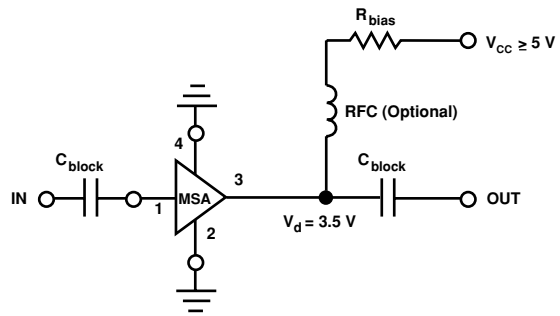

### MSA-0686 Absolute Maximum Ratings

Parameter	Absolute Maximum <sup>[1]</sup>
Device Current	50 mA
Power Dissipation <sup>[2,3]</sup>	200 mW
RF Input Power	+13 dBm
Junction Temperature	150°C
Storage Temperature	-65 to 150°C

### Thermal Resistance<sup>[2]:</sup>

$$\theta_{jc} = 120^{\circ}\text{C}/\text{W}$$

#### Notes:

1. Permanent damage may occur if any of these limits are exceeded.
2.  $T_{\text{CASE}} = 25^{\circ}\text{C}$ .
3. Derate at  $8.3 \text{ mW}/^{\circ}\text{C}$  for  $T_{\text{C}} > 126^{\circ}\text{C}$ .

### Electrical Specifications<sup>[1]</sup>, $T_{\text{A}} = 25^{\circ}\text{C}$

Symbol	Parameters and Test Conditions: $I_{\text{d}} = 16 \text{ mA}$ , $Z_{\text{o}} = 50 \Omega$	Units	Min.	Typ.	Max.
$G_{\text{P}}$	Power Gain ( $ S_{21} ^2$ ) $f = 0.1 \text{ GHz}$ $f = 0.5 \text{ GHz}$	dB	16.5	20.0 18.5	
$\Delta G_{\text{P}}$	Gain Flatness $f = 0.1 \text{ to } 0.5 \text{ GHz}$	dB		$\pm 0.7$	
$f_{3 \text{ dB}}$	3 dB Bandwidth	GHz		0.8	
VSWR	Input VSWR $f = 0.1 \text{ to } 1.5 \text{ GHz}$			1.7:1	
	Output VSWR $f = 0.1 \text{ to } 1.5 \text{ GHz}$			1.7:1	
NF	50 $\Omega$ Noise Figure $f = 0.5 \text{ GHz}$	dB		3.0	
$P_{1 \text{ dB}}$	Output Power at 1 dB Gain Compression $f = 0.5 \text{ GHz}$	dBm		2.0	
$\text{IP}_3$	Third Order Intercept Point $f = 0.5 \text{ GHz}$	dBm		14.5	
$t_{\text{D}}$	Group Delay $f = 0.5 \text{ GHz}$	psec		225	
$V_{\text{d}}$	Device Voltage	V	2.8	3.5	4.2
$\text{dV}/\text{dT}$	Device Voltage Temperature Coefficient	$\text{mV}/^{\circ}\text{C}$		-8.0	

#### Notes:

1. The recommended operating current range for this device is 12 to 20 mA. Typical performance as a function of current is on the following page.

### Ordering Information

Part Numbers	No. of Devices	Comments
MSA-0686-BLK	100	Bulk
MSA-0686-BLKG	100	Bulk
MSA-0686-TR1	1000	7" Reel
MSA-0686-TR1G	1000	7" Reel
MSA-0686-TR2	4000	13" Reel
MSA-0686-TR2G	1000	13" Reel

**Note:** Order part number with a "G" suffix if lead-free option is desired.

**MSA-0686 Typical Scattering Parameters ( $Z_0 = 50 \Omega$ ,  $T_A = 25^\circ\text{C}$ ,  $I_d = 16 \text{ mA}$ )**

Freq. GHz	$S_{11}$		$S_{21}$			$S_{12}$			$S_{22}$		k
	Mag	Ang	dB	Mag	Ang	dB	Mag	Ang	Mag	Ang	
0.1	.06	-175	20.1	10.08	170	-23.3	.069	4	.04	-84	1.05
0.2	.06	-169	19.8	9.77	161	-23.2	.069	8	.07	-103	1.05
0.3	.07	-164	19.4	9.35	152	-22.5	.075	13	.10	-113	1.03
0.4	.08	-158	19.1	8.98	144	-22.2	.078	16	.13	-123	1.02
0.5	.08	-154	18.7	8.58	135	-21.6	.083	18	.15	-131	1.01
0.6	.09	-152	18.0	7.94	128	-21.1	.088	21	.18	-140	1.01
0.8	.12	-152	17.2	7.25	114	-20.3	.097	25	.21	-155	1.00
1.0	.15	-154	16.3	6.51	102	-19.5	.106	25	.24	-168	0.99
1.5	.25	-171	14.0	5.01	76	-17.6	.133	22	.27	165	0.99
2.0	.34	171	11.9	3.94	56	-16.1	.157	19	.27	147	1.01
2.5	.43	155	9.8	3.09	42	-15.9	.161	16	.27	134	1.06
3.0	.49	140	8.0	2.51	28	-15.3	.171	11	.26	124	1.10
3.5	.56	128	6.4	2.09	15	-15.1	.175	6	.25	118	1.13
4.0	.61	118	5.0	1.78	3	-14.9	.180	3	.24	115	1.15
5.0	.70	99	2.4	1.32	-18	-14.7	.185	-2	.24	118	1.16

**Typical Performance,  $T_A = 25^\circ\text{C}$** 

(unless otherwise noted)

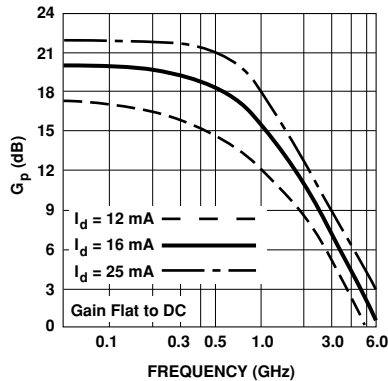
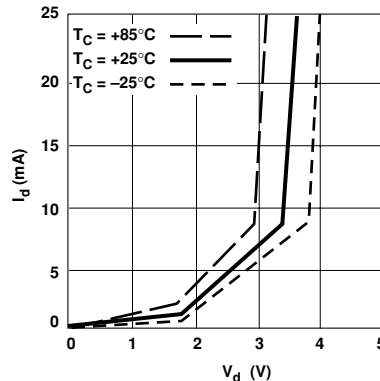
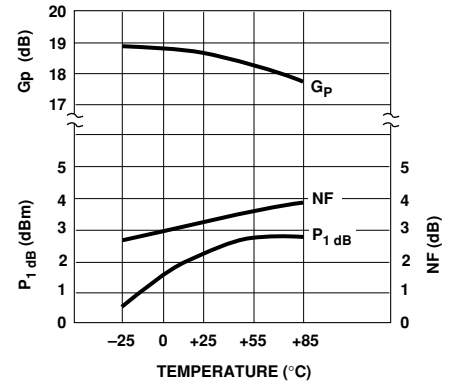
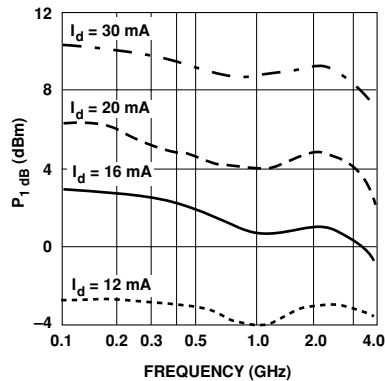
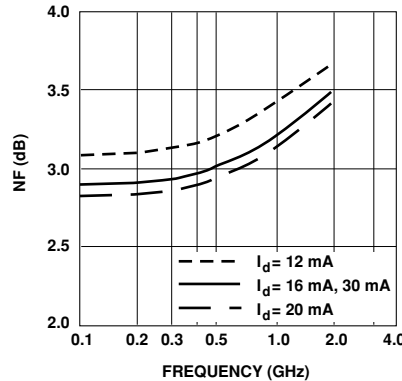
**Figure 1. Typical Power Gain vs. Frequency,  $T_A = 25^\circ\text{C}$ .**

**Figure 2. Device Current vs. Voltage.**

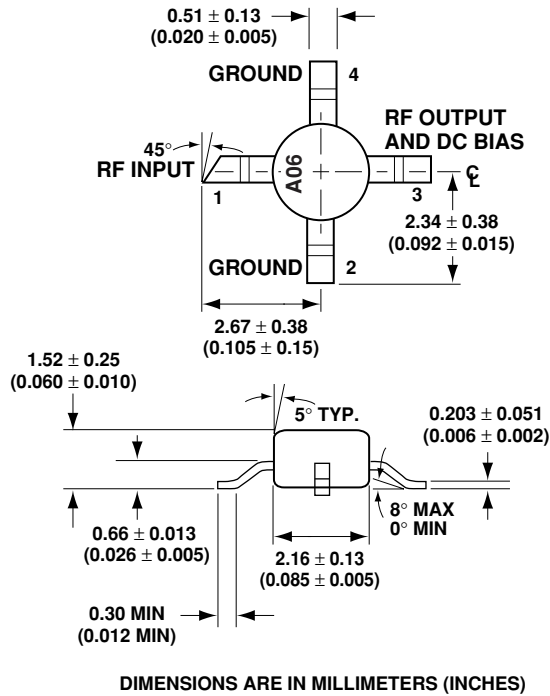
**Figure 3. Output Power at 1 dB Gain Compression, NF and Power Gain vs. Case Temperature,  $f = 1.0 \text{ GHz}$ ,  $I_d = 16 \text{ mA}$ .**

**Figure 4. Output Power at 1 dB Gain Compression vs. Frequency.**

**Figure 5. Noise Figure vs. Frequency.**

## 86 Plastic Package Dimensions





For product information and a complete list of distributors, please go to our web site:  
[www.avagotech.com](http://www.avagotech.com)

Avago, Avago Technologies, and the A logo are trademarks of Avago Technologies, Limited in the United States and other countries.  
 Data subject to change. Copyright © 2006 Avago Technologies, Limited. All rights reserved.  
 Obsoletes 5965-9588EN  
 5989-2757EN May 11, 2006



## Looking for pricing, stock, or lifecycle information?

Click below to explore more details on WIN SOURCE:

-  [View MSA-0686-TR1G on WIN SOURCE](#)
-  [Broadcom Limited Information](#)

## Optimize Your Supply Chain with WIN SOURCE Solutions

-  Global Sourcing Solution
-  Obsolete Management
-  Cost Control Management
-  Shortage Management
-  Alternative Solution
-  Excess Inventory Management