



**THE DATASHEET OF
MSA-0486-BLKG**



MSA-0486

Cascadable Silicon Bipolar MMIC Amplifier



Data Sheet

Description

The MSA-0486 is a high performance silicon bipolar Monolithic Microwave Integrated Circuit (MMIC) housed in a low cost, surface mount plastic package. This MMIC is designed for use as a general purpose 50 Ω gain block. Typical applications include narrow and broad band IF and RF amplifiers in commercial and industrial applications.

The MSA-series is fabricated using Avago's 10 GHz f_T , 25 GHz f_{MAX} , silicon bipolar MMIC process which uses nitride self-alignment, ion implantation, and gold metalization to achieve excellent performance, uniformity and reliability. The use of an external bias resistor for temperature and current stability also allows bias flexibility.

Features

- Lead-free Option Available
- Cascadable 50 Ω Gain Block
- 3 dB Bandwidth: DC to 3.2 GHz
- 8 dB Typical Gain at 1.0 GHz
- 12.5 dBm Typical $P_{1\text{ dB}}$ at 1.0 GHz
- Unconditionally Stable ($k > 1$)
- Surface Mount Plastic Package
- Tape-and-Reel Packaging Option Available

86 Plastic Package

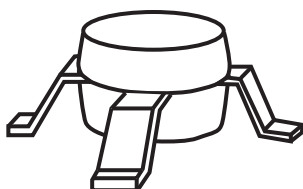

Typical Biasing Configuration

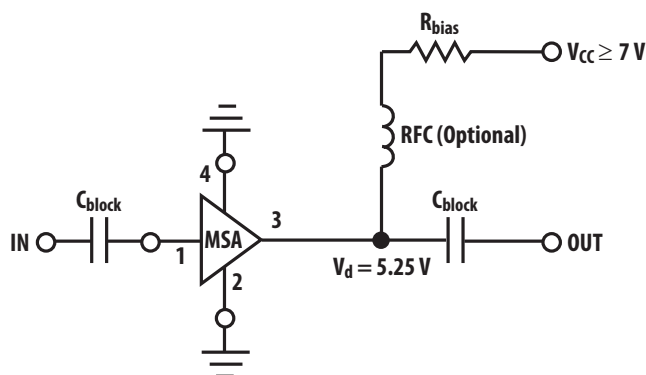

MSA-0486 Absolute Maximum Ratings

Parameter	Absolute Maximum ^[1]
Device Current	85 mA
Power Dissipation ^[2, 3]	500 mW
RF Input Power	+13 dBm
Junction Temperature	150° C
Storage Temperature	-65 to 150° C

Thermal Resistance ^[2, 4]:
 $\theta_{jc} = 100^{\circ}\text{C/W}$

Notes:

1. Permanent damage may occur if any of these limits are exceeded.
2. $T_{\text{CASE}} = 25^{\circ}\text{C}$.
3. Derate at 9.5 mW/°C for $T_C > 100^{\circ}\text{C}$.

Electrical Specifications^[1], $T_A = 25^{\circ}\text{C}$

Symbol	Parameters and Test Conditions: $I_d = 50\text{ mA}$, $Z_0 = 50\ \Omega$	Units	Min.	Typ.	Max.
G_p	Power Gain ($ S_{21} ^2$) f = 0.1 GHz f = 1.0 GHz	dB	7.0	8.3 8.0	
ΔG_p	Gain Flatness f = 0.1 to 2.0 GHz	dB		+0.6	
$f_{3\text{ dB}}$	3 dB Bandwidth ^[2]	GHz		3.2	
VSWR	Input VSWR f = 0.1 to 3.0 GHz			1.5:1	
	Output VSWR f = 0.1 to 3.0 GHz			1.9:1	
NF	50 Ω Noise Figure f = 1.0 GHz	dB		7.0	
$P_{1\text{ dB}}$	Output Power at 1 dB Gain Compression f = 1.0 GHz	dBm		12.5	
IP ₃	Third Order Intercept Point f = 1.0 GHz	dBm		25.5	
t_D	Group Delay f = 1.0 GHz	psec		140	
V_d	Device Voltage	V	4.2	5.25	6.3
dV/dT	Device Voltage Temperature Coefficient	mV/°C		-8.0	

Notes:

1. The recommended operating current range for this device is 30 to 70 mA. Typical performance as a function of current is on the following page.

Ordering Information

Part Numbers	No. of Devices	Comments
MSA-0486-BLK	100	Bulk
MSA-0486-BLKG	100	Bulk
MSA-0486-TR1	1000	7" Reel
MSA-0486-TR1G	1000	7" Reel
MSA-0486-TR2	4000	13" Reel
MSA-0486-TR2G	4000	13" Reel

Note: Order part number with a "G" suffix if lead-free option is desired.

MSA-0486 Typical Scattering Parameters ($Z_0 = 50 \Omega$, $T_A = 25^\circ \text{C}$, $I_d = 50 \text{ mA}$)

Freq. GHz	S_{11}		S_{21}		S_{12}		S_{22}			
	Mag	Ang	dB	Mag	Ang	dB	Mag	Ang	Mag	Ang
0.1	0.14	178	8.4	2.62	175	-16.2	0.154	1	0.16	-10
0.2	0.14	175	8.3	2.61	170	-16.3	0.153	2	0.16	-20
0.4	0.14	171	8.2	2.57	161	-16.2-3	0.154	3	0.16-7	-39
0.6	0.13	168	8.1	2.54	151	-16.0	0.158	4	0.18	-57
0.8	0.13	166	8.0	2.52	141	-5.9	0.161	5	0.20	-74
1.0	0.13	165	7.9	2.48	131	-15.7	0.165	6	0.18	-88
1.5	0.15	168	7.7	2.42	108	-14.8	0.182	8	0.27	-121
2.0	0.21	168	7.3	2.32	84	-14.0	0.199	7	0.32	-149
2.5	0.18	165	6.8	2.18	65	-13.1	0.222	4	0.38	-168
3.0	0.37	153	5.9	1.97	43	-12.7	0.231	-1	0.40	173
3.5	0.44	142	4.8	1.74	24	-12.5	0.238	-5	0.41	157
4.0	0.50	130	3.6	1.52	7	-12.5	0.238	-10	0.41	145
5.0	0.61	109	1.3	1.16	-21	-12.7	0.231	-17	0.43	132

Typical Performance, $T_A = 25^\circ\text{C}$

(unless otherwise noted)

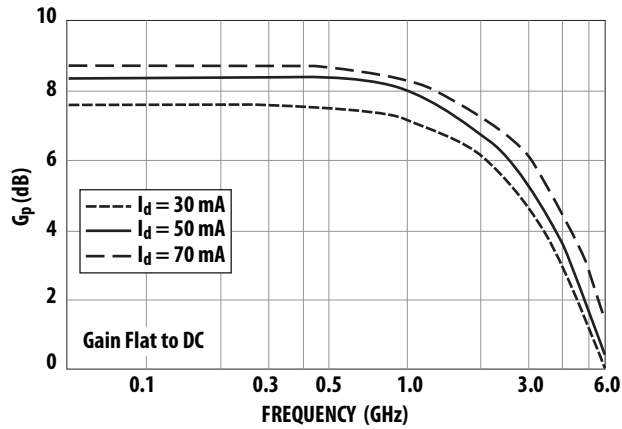

Figure 1. Typical Power Gain vs Frequency, $T_A = 25^\circ\text{C}$.

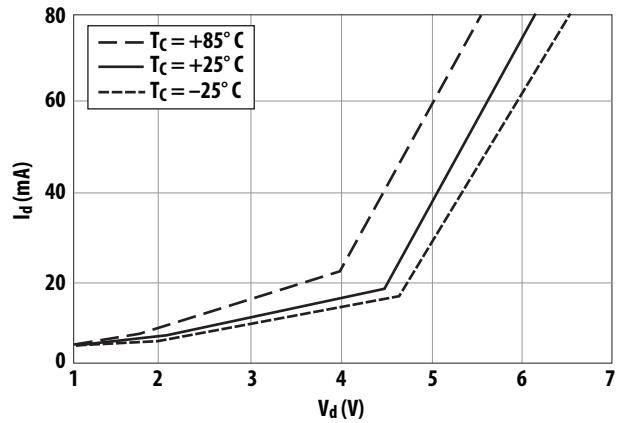

Figure 2. Device Current vs. Voltage.

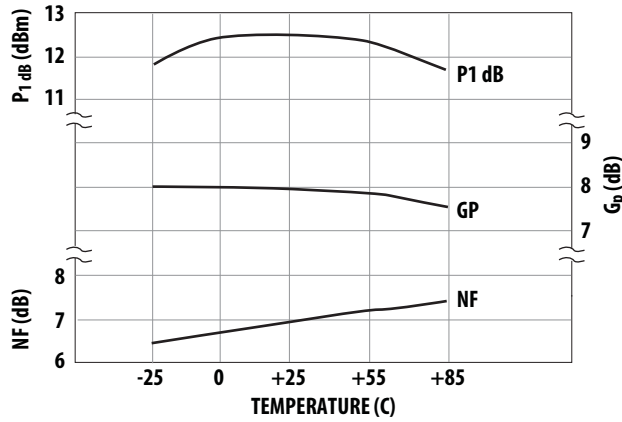

Figure 3. Output Power at 1 dB Gain Compression, NF and Power Gain vs. Case Temperature, $f = 1.0\text{ GHz}$, $I_d = 50\text{ mA}$.

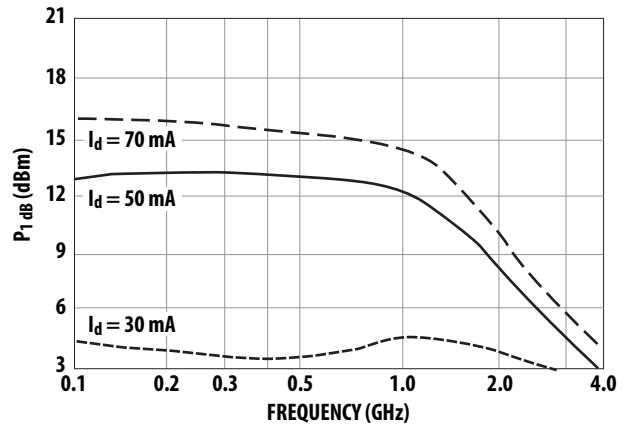

Figure 4. Output Power at 1 dB Gain Compression vs. Frequency.

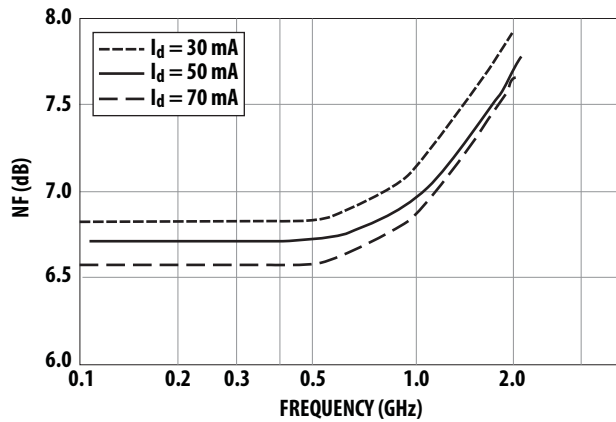
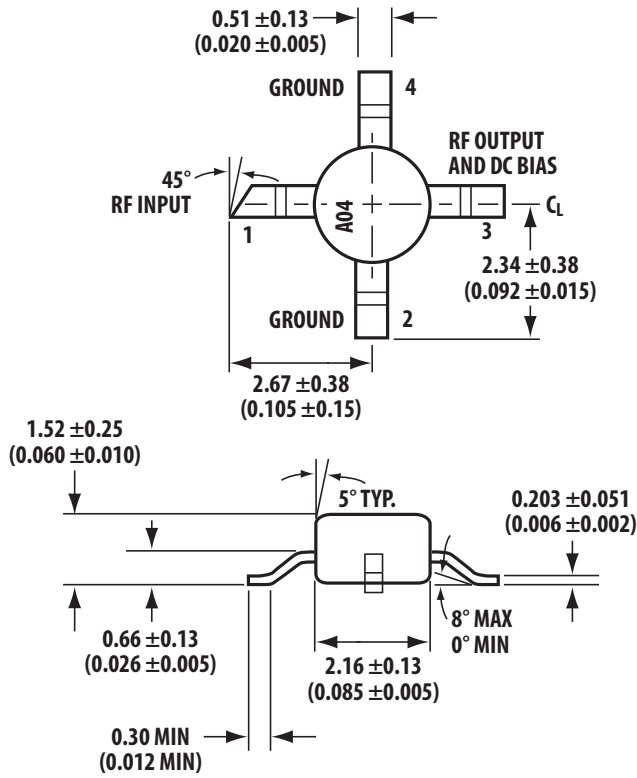

Figure 5. Noise Figure vs. Frequency.

86 Plastic Package Dimensions



Dimensions are in millimeters (inches)



For product information and a complete list of distributors, please go to our web site: www.avagotech.com

Avago, Avago Technologies, and the A logo are trademarks of Avago Technologies in the United States and other countries. Data subject to change. Copyright © 2005-2012 Avago Technologies. All rights reserved. Obsoletes 5989-2753EN AV02-3582EN - June 11, 2012

Avago
TECHNOLOGIES

Looking for pricing, stock, or lifecycle information?

Click below to explore more details on WIN SOURCE:

-  [View MSA-0486-BLKG on WIN SOURCE](#)
-  [Broadcom Limited Information](#)

Optimize Your Supply Chain with WIN SOURCE Solutions

-  Global Sourcing Solution
-  Obsolete Management
-  Cost Control Management
-  Shortage Management
-  Alternative Solution
-  Excess Inventory Management