



**THE DATASHEET OF  
MSA-0386-BLK**



# MSA-0386

## Cascadable Silicon Bipolar MMIC Amplifier



### Data Sheet

#### Description

The MSA-0386 is a high performance silicon bipolar Monolithic Microwave Integrated Circuit (MMIC) housed in a low cost, surface mount plastic package. This MMIC is designed for use as a general purpose 50 Ω gain block. Typical applications include narrow and broad band IF and RF amplifiers in commercial and industrial applications.

The MSA-series is fabricated using Avago's 10 GHz  $f_T$ , 25 GHz  $f_{MAX}$ , silicon bipolar MMIC process which uses nitride self-alignment, ion implantation, and gold metalization to achieve excellent performance, uniformity and reliability. The use of an external bias resistor for temperature and current stability also allows bias flexibility.

#### Features

- Lead-free Option Available
- Cascadable 50 Ω Gain Block
- 3 dB Bandwidth: DC to 2.4 GHz
- 12.0 dB Typical Gain at 1.0 GHz
- 10.0 dBm Typical  $P_{1\text{ dB}}$  at 1.0 GHz
- Unconditionally Stable ( $k > 1$ )
- Surface Mount Plastic Package
- Tape-and-Reel Packaging Option Available

#### 86 Plastic Package

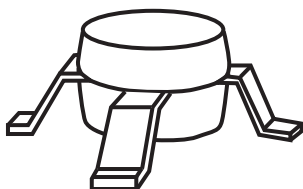

#### Typical Biasing Configuration

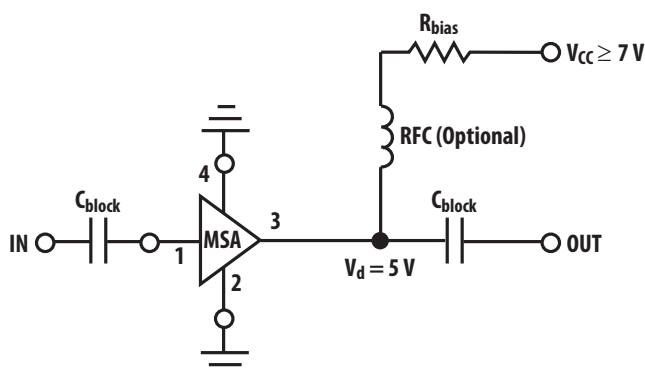

## MSA-0386 Absolute Maximum Ratings

Parameter	Absolute Maximum <sup>[1]</sup>
Device Current	70 mA
Power Dissipation <sup>[2, 3]</sup>	400 mW
RF Input Power	+13 dBm
Junction Temperature	150° C
Storage Temperature	-65 to 150° C

### Thermal Resistance <sup>[2]</sup>:

$$\theta_{jc} = 115^{\circ}\text{C/W}$$

Notes:

1. Permanent damage may occur if any of these limits are exceeded.
2.  $T_{\text{CASE}} = 25^{\circ}\text{C}$ .
3. Derate at 9.5 mW/°C for  $T_C > 116^{\circ}\text{C}$ .

## Electrical Specifications<sup>[1]</sup>, $T_A = 25^{\circ}\text{C}$

Symbol	Parameters and Test Conditions: $I_d = 35\text{ mA}$ , $Z_0 = 50\ \Omega$	Units	Min.	Typ.	Max.
$G_p$	Power Gain ( $ S_{21} ^2$ ) f = 0.1 GHz f = 1.0 GHz	dB	10.0	12.5 12.0	
$\Delta G_p$	Gain Flatness f = 0.1 to 1.6 GHz	dB		+0.7	
$f_{3\text{ dB}}$	3 dB Bandwidth <sup>[2]</sup>	GHz		2.4	
VSWR	Input VSWR f = 0.1 to 3.0 GHz			1.5:1	
	Output VSWR f = 0.1 to 3.0 GHz			1.7:1	
NF	50 $\Omega$ Noise Figure f = 1.0 GHz	dB		6.0	
$P_{1\text{ dB}}$	Output Power at 1 dB Gain Compression f = 1.0 GHz	dBm		10.0	
$IP_3$	Third Order Intercept Point f = 1.0 GHz	dBm		23.0	
$t_D$	Group Delay f = 1.0 GHz	psec		140	
$V_d$	Device Voltage	V	4.0	5.0	6.0
dV/dT	Device Voltage Temperature Coefficient	mV/°C		-8.0	

Notes:

1. The recommended operating current range for this device is 20 to 40 mA. Typical performance as a function of current is on the following page.

## Ordering Information

Part Numbers	No. of Devices	Comments
MSA-0386-BLK	100	Bulk
MSA-0386-BLKG	100	Bulk
MSA-0386-TR1	1000	7" Reel
MSA-0386-TR1G	1000	7" Reel
MSA-0386-TR2	4000	13" Reel
MSA-0386-TR2G	4000	13" Reel

Note: Order part number with a "G" suffix if lead-free option is desired.

**MSA-0386 Typical Scattering Parameters ( $Z_0 = 50 \Omega$ ,  $T_A = 25^\circ \text{C}$ ,  $I_d = 35 \text{ mA}$ )**

Freq. GHz	$S_{11}$		$S_{21}$		$S_{12}$		$S_{22}$		Mag	Ang
	Mag	Ang	dB	Mag	Ang	dB	Mag	Ang		
0.1	0.11	174	12.5	4.22	175	-18.3	0.122	1	0.13	-11
0.2	0.11	169	12.5	4.20	170	-18.2	0.124	2	0.13	-20
0.4	0.11	159	12.4	4.16	159	-18.1	0.124	5	0.14	-41
0.6	0.10	149	12.2	4.09	149	-17.9	0.128	8	0.15	-60
0.8	0.10	142	12.1	4.00	139	-17.6	0.131	9	0.16	-78
1.0	0.09	137	11.9	3.93	129	-17.4	0.136	11	0.18	-93
1.5	0.09	139	11.2	3.61	106	-16.6	0.149	14	0.20	-129
2.0	0.12	149	10.3	3.28	83	-15.3	0.171	13	0.23	-157
2.5	0.18	150	9.4	2.95	66	-14.4	0.190	12	0.26	-176
3.0	0.25	142	83	2.60	48	-13.7	0.207	9	0.29	167
3.5	0.32	133	7.2	2.29	31	-13.2	0.219	3	0.30	152
4.0	0.40	124	6.0	2.01	15	-13.0	0.224	-1	0.31	142
5.0	0.53	106	3.7	1.53	-13	-12.8	0.228	-11	032	128

## Typical Performance, $T_A = 25^\circ\text{C}$

(unless otherwise noted)

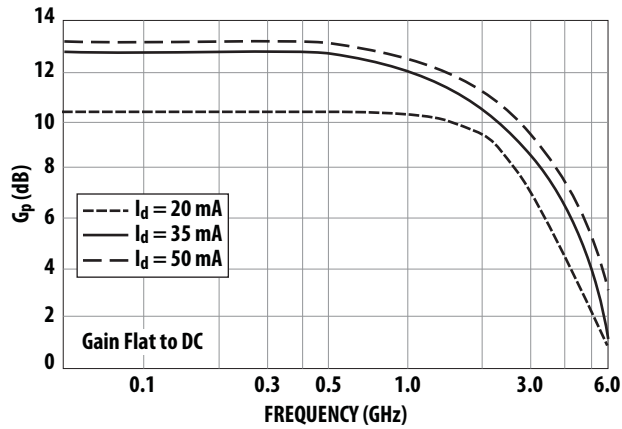

Figure 1. Typical Power Gain vs Frequency,  $T_A = 25^\circ\text{C}$ .

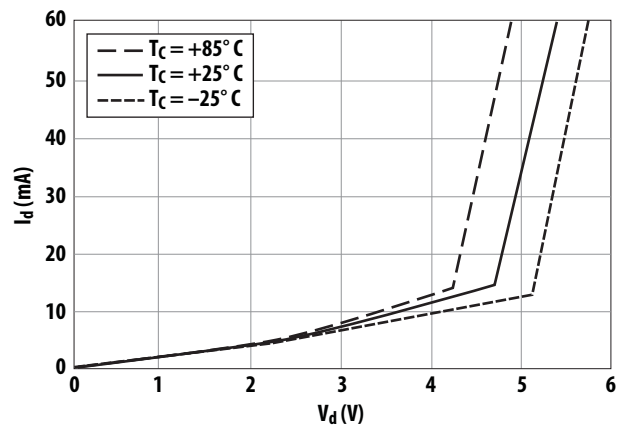

Figure 2. Device Current vs. Voltage.

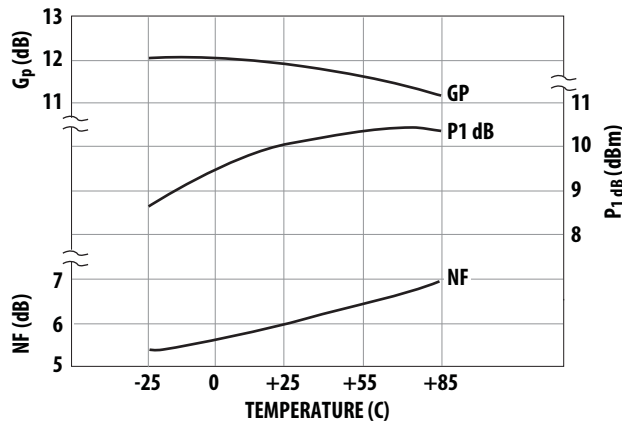

Figure 3. Output Power at 1 dB Gain Compression, NF and Power Gain. Case Temperature,  $f = 1.0\text{ GHz}$ ,  $I_d = 35\text{ mA}$ .

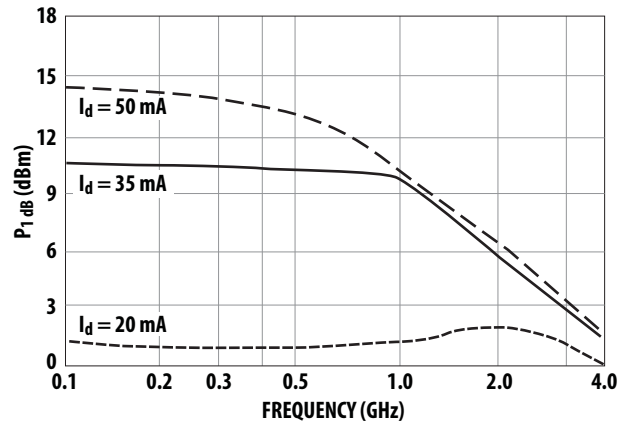

Figure 4. Output Power at 1 dB Gain Compression vs. Frequency.

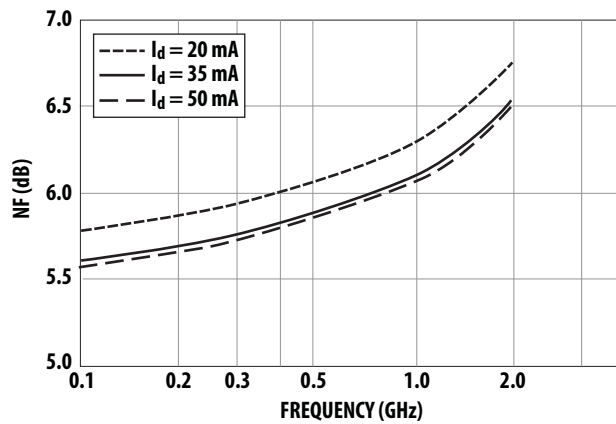
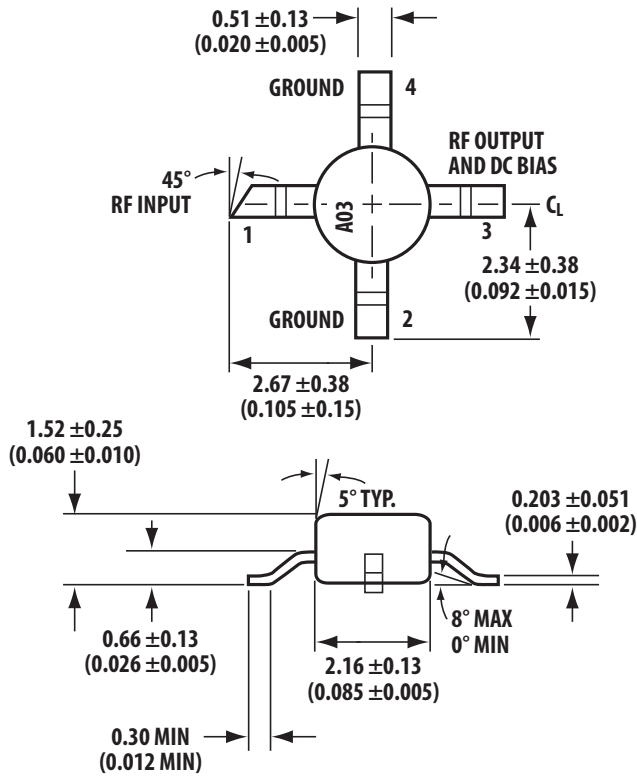

Figure 5. Noise Figure vs. Frequency.

## 86 Plastic Package Dimensions



Dimensions are in millimeters (inches)

For product information and a complete list of distributors, please go to our web site: [www.avagotech.com](http://www.avagotech.com)

Avago, Avago Technologies, and the A logo are trademarks of Avago Technologies in the United States and other countries. Data subject to change. Copyright © 2005-2012 Avago Technologies. All rights reserved. Obsoletes 5989-2751EN AV02-3581EN - June 11, 2012

**Avago**  
TECHNOLOGIES

## Looking for pricing, stock, or lifecycle information?

Click below to explore more details on WIN SOURCE:

 [View MSA-0386-BLK on WIN SOURCE](#)

 [Broadcom Limited](#) Information

## Optimize Your Supply Chain with WIN SOURCE Solutions

-  Global Sourcing Solution
-  Obsolete Management
-  Cost Control Management
-  Shortage Management
-  Alternative Solution
-  Excess Inventory Management