



**THE DATASHEET OF
MPZ1608Y151BTA00**



Chip beads
For power line
MPZ series



MPZ1608 type



FEATURES

- Noise reduction solution for power line.
- Compared to the MMZ series, has low direct current resistance for compatibility with large currents, optimal for low power consumption.
- Various frequency characteristics with 5 materials of different features for countermeasures against everything from general signals to high-speed signals.
- Performs well even in signal lines where low direct current resistance is required.
- Operating temperature range: -55 to +125°C

APPLICATION

- Noise removal for mobile devices such as smartphones and tablet terminals, and various modules.
- Noise removal for PCs and recorders, household appliances such as STBs, smart grids, and industrial equipment.

PART NUMBER CONSTRUCTION

| | | | | | | |
|-------------|--|---------------|----------------------------|------------------------|-----------------|---------------|
| MPZ | 1608 | B | 471 | A | T | A00 |
| Series name | L×W×T dimensions 1.6×0.8×0.6 mm 1.6×0.8×0.8 mm | Material name | Impedance (Ω) at 100MHz | Characteristic type | Packaging style | Internal code |

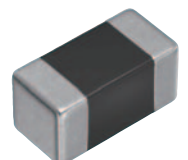

MPZ1608 type

CHARACTERISTICS SPECIFICATION TABLE

| Impedance [100MHz] (Ω) | DC resistance (Ω)max. | Rated current* (A)max. | Thickness T (mm) | Part No. | |
|---------------------------------------|-----------------------------------|---------------------------|---------------------|----------|----------------------------------|
| 470 | $\pm 25\%$ | 0.150 | 1.0 | 0.8 | MPZ1608B471ATA00 |
| 26 | $\pm 25\%$ | 0.007 | 6.0 | 0.6 | MPZ1608S260ATAH0 |
| 30 | $\pm 10\Omega$ | 0.010 | 5.0 | 0.6 | MPZ1608S300ATAH0 |
| 60 | $\pm 25\%$ | 0.020 | 3.5 | 0.6 | MPZ1608S600ATAH0 |
| 100 | $\pm 25\%$ | 0.030 | 3.0 | 0.6 | MPZ1608S101ATAH0 |
| 120 | $\pm 25\%$ | 0.045 | 2.0 | 0.6 | MPZ1608S121ATAH0 |
| 180 | $\pm 25\%$ | 0.050 | 2.0 | 0.6 | MPZ1608S181ATAH0 |
| 220 | $\pm 25\%$ | 0.050 | 2.2 | 0.8 | MPZ1608S221ATA00 |
| 330 | $\pm 25\%$ | 0.080 | 1.7 | 0.8 | MPZ1608S331ATA00 |
| 470 | $\pm 25\%$ | 0.150 | 1.0 | 0.8 | MPZ1608S471ATA00 |
| 600 | $\pm 25\%$ | 0.150 | 1.0 | 0.8 | MPZ1608S601ATA00 |
| 1000 | $\pm 25\%$ | 0.300 | 0.8 | 0.8 | MPZ1608S102ATA00 |
| 390 | $\pm 25\%$ | 0.120 | 1.2 | 0.8 | MPZ1608R391ATA00 |
| 60 | $\pm 25\%$ | 0.030 | 2.3 | 0.8 | MPZ1608Y600BTA00 |
| 100 | $\pm 25\%$ | 0.040 | 2.0 | 0.8 | MPZ1608Y101BTA00 |
| 150 | $\pm 25\%$ | 0.050 | 1.8 | 0.8 | MPZ1608Y151BTA00 |
| 220 | $\pm 25\%$ | 0.100 | 1.5 | 0.8 | MPZ1608Y221BTA00 |
| 30 | $\pm 10\Omega$ | 0.060 | 1.8 | 0.8 | MPZ1608D300BTA00 |
| 60 | $\pm 25\%$ | 0.100 | 1.2 | 0.8 | MPZ1608D600BTA00 |
| 100 | $\pm 25\%$ | 0.150 | 1.0 | 0.8 | MPZ1608D101BTA00 |

* Please refer to the graph of rated current vs. temperature characteristics (derating) about the rating current at 85°C or more in temperature of the product.

Measurement equipment

| Measurement item | Product No. | Manufacturer |
|------------------|---------------|-----------------------|
| Impedance | E4991A+16192A | Keysight Technologies |
| DC resistance | Type-7556 | Yokogawa |

* Equivalent measurement equipment may be used.

Rated current vs. temperature characteristics (derating)

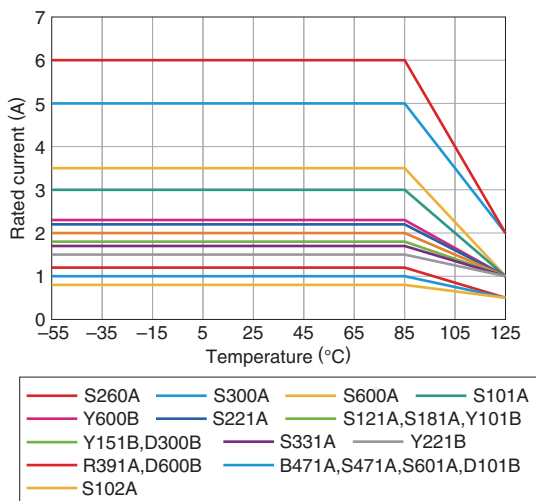

MPZ1608 type

Z VS. FREQUENCY CHARACTERISTICS (BY SERIES)

MPZ1608B series



MPZ1608S series

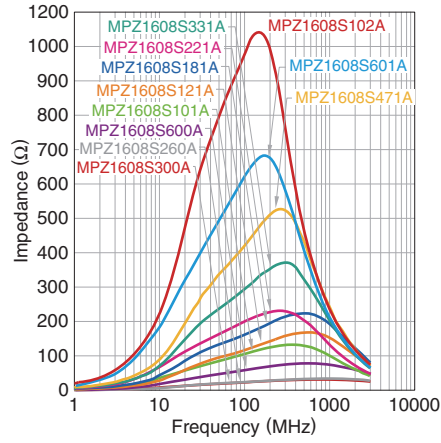

MPZ1608R series



MPZ1608Y series



MPZ1608D series

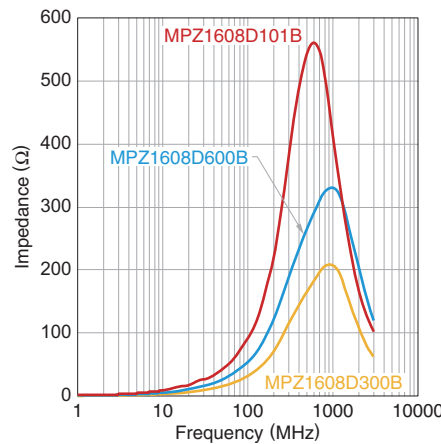

MPZ1608 type

Z, X, R VS. FREQUENCY CHARACTERISTICS

MPZ1608B471ATA00



MPZ1608S260ATAH0



MPZ1608S300ATAH0

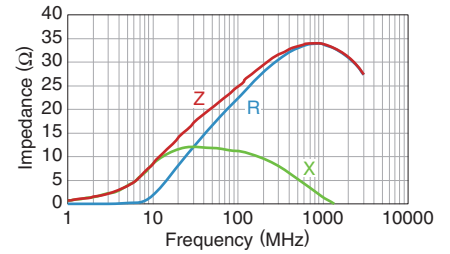

MPZ1608S600ATAH0



MPZ1608S101ATAH0

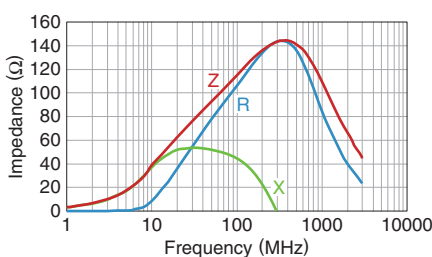

MPZ1608S121ATAH0

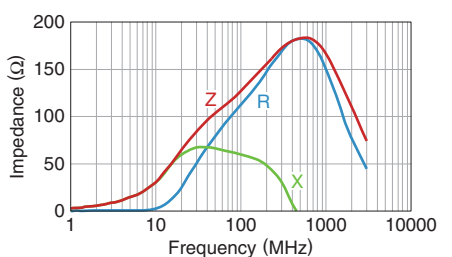

MPZ1608S181ATAH0



MPZ1608S221ATA00



MPZ1608S331ATA00

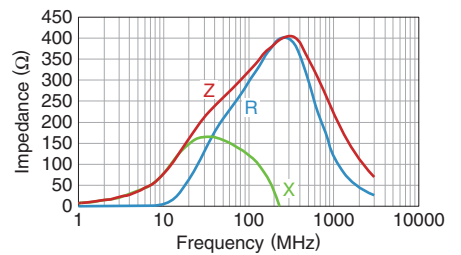

MPZ1608S471ATA00

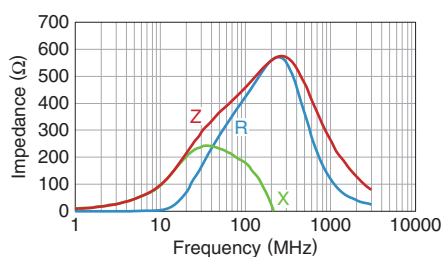

MPZ1608S601ATA00

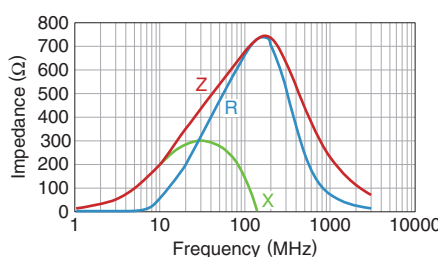

MPZ1608S102ATA00

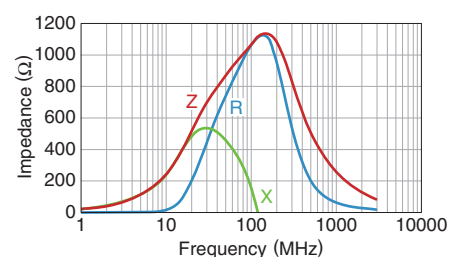

MPZ1608R391ATA00



MPZ1608Y600BTA00

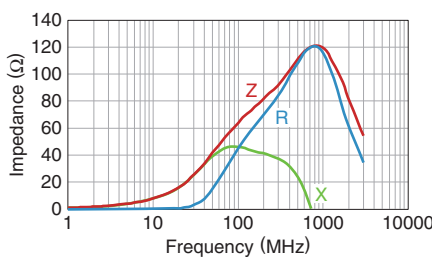

MPZ1608Y101BTA00

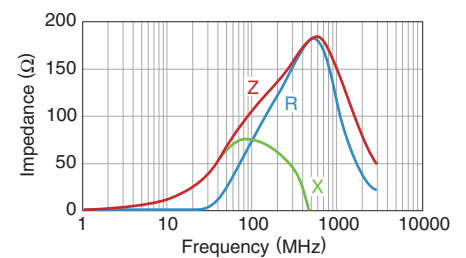

MPZ1608 type

Z, X, R VS. FREQUENCY CHARACTERISTICS

MPZ1608Y151BTA00



MPZ1608Y221BTA00



MPZ1608D300BTA00



MPZ1608D600BTA00

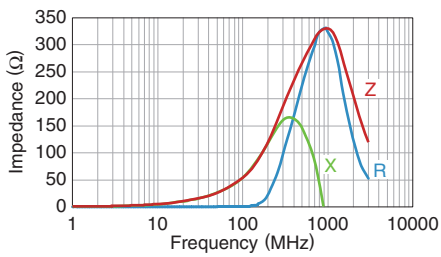

MPZ1608D101BTA00

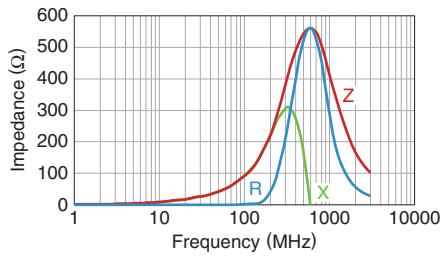

MPZ1608 type

SHAPE & DIMENSIONS

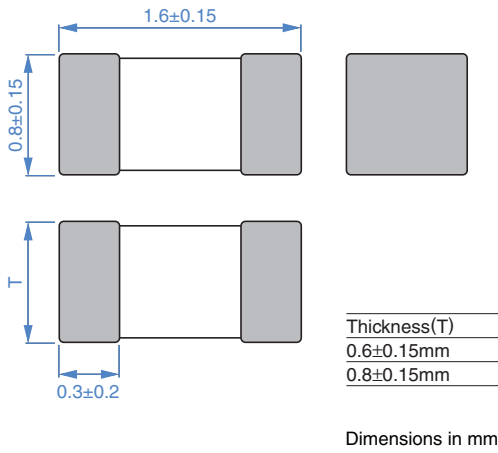

PACKAGING STYLE

REEL DIMENSIONS



RECOMMENDED LAND PATTERN



TAPE DIMENSIONS



RECOMMENDED REFLOW PROFILE



| Type | A | B | K |
|---------|---------|---------|---------|
| MPZ1608 | 1.1±0.2 | 1.9±0.2 | 1.1max. |



PACKAGE QUANTITY

| | |
|------------------|----------------|
| Package quantity | 4,000 pcs/reel |
|------------------|----------------|

TEMPERATURE RANGE, INDIVIDUAL WEIGHT

| Type | Operating temperature range | Storage temperature range* | Individual weight |
|---------|-----------------------------|----------------------------|-------------------|
| t=0.6mm | -55 to +125°C | -55 to +125°C | 3 mg |
| t=0.8mm | -55 to +125°C | -55 to +125°C | 4 mg |

* The storage temperature range is for after the assembly.

REMINDERS FOR USING THESE PRODUCTS

Before using these products, be sure to request the delivery specifications.

SAFETY REMINDERS

Please pay sufficient attention to the warnings for safe designing when using this products.

REMINDERS

- The storage period is within 12 months. Be sure to follow the storage conditions (temperature: 5 to 40°C, humidity: 10 to 75% RH or less).
If the storage period elapses, the soldering of the terminal electrodes may deteriorate.
- Do not use or store in locations where there are conditions such as gas corrosion (salt, acid, alkali, etc.).
- Before soldering, be sure to preheat components.
The preheating temperature should be set so that the temperature difference between the solder temperature and chip temperature does not exceed 150°C.
- Soldering corrections after mounting should be within the range of the conditions determined in the specifications.
If overheated, a short circuit, performance deterioration, or lifespan shortening may occur.
- When embedding a printed circuit board where a chip is mounted to a set, be sure that residual stress is not given to the chip due to the overall distortion of the printed circuit board and partial distortion such as at screw tightening portions.
- Self heating (temperature increase) occurs when the power is turned ON, so the tolerance should be sufficient for the set thermal design.
- Carefully lay out the coil for the circuit board design of the non-magnetic shield type.
A malfunction may occur due to magnetic interference.
- Use a wrist band to discharge static electricity in your body through the grounding wire.
- Do not expose the products to magnets or magnetic fields.
- Do not use for a purpose outside of the contents regulated in the delivery specifications.
- The products listed on this catalog are intended for use in general electronic equipment (AV equipment, telecommunications equipment, home appliances, amusement equipment, computer equipment, personal equipment, office equipment, measurement equipment, industrial robots) under a normal operation and use condition.
The products are not designed or warranted to meet the requirements of the applications listed below, whose performance and/or quality require a more stringent level of safety or reliability, or whose failure, malfunction or trouble could cause serious damage to society, person or property.
If you intend to use the products in the applications listed below or if you have special requirements exceeding the range or conditions set forth in the each catalog, please contact us.

- (1) Aerospace/aviation equipment
- (2) Transportation equipment (cars, electric trains, ships, etc.)
- (3) Medical equipment
- (4) Power-generation control equipment
- (5) Atomic energy-related equipment
- (6) Seabed equipment
- (7) Transportation control equipment

- (8) Public information-processing equipment
- (9) Military equipment
- (10) Electric heating apparatus, burning equipment
- (11) Disaster prevention/crime prevention equipment
- (12) Safety equipment
- (13) Other applications that are not considered general-purpose applications

When designing your equipment even for general-purpose applications, you are kindly requested to take into consideration securing protection circuit/device or providing backup circuits in your equipment.

Looking for pricing, stock, or lifecycle information?

Click below to explore more details on WIN SOURCE:

- ⊖ [View MPZ1608Y151BTA00 on WIN SOURCE](#)
- ⊖ [TDK Corporation](#) Information

Optimize Your Supply Chain with WIN SOURCE Solutions

- ✓ Global Sourcing Solution
- ✓ Obsolete Management
- ✓ Cost Control Management
- ✓ Shortage Management
- ✓ Alternative Solution
- ✓ Excess Inventory Management