



**THE DATASHEET OF
MPC9447FA**



3.3V/2.5V 1:9 LVCMOS Clock Fanout Buffer

The MPC9447 is a 3.3V or 2.5V compatible, 1:9 clock fanout buffer targeted for high performance clock tree applications. With output frequencies up to 350 MHz and output skews less than 150 ps, the device meets the needs of most demanding clock applications.

Features

- 9 LVCMOS Compatible Clock Outputs
- 2 Selectable, LVCMOS Compatible Inputs
- Maximum Clock Frequency of 350 MHz
- Maximum Clock Skew of 150 ps
- Synchronous Output Stop in Logic Low State Eliminates Output Runt Pulses
- High-Impedance Output Control
- 3.3V or 2.5V Power Supply
- Drives up to 18 Series Terminated Clock Lines
- Ambient Temperature Range -40°C to +85°C
- 32 Lead LQFP Packaging
- Supports Clock Distribution in Networking, Telecommunications, and Computer Applications
- Pin and Function Compatible to MPC947

Functional Description

MPC9447 is specifically designed to distribute LVCMOS compatible clock signals up to a frequency of 350 MHz. Each output provides a precise copy of the input signal with a near zero skew. The outputs buffers support driving of 50Ω terminated transmission lines on the incident edge: each is capable of driving either one parallel terminated or two series terminated transmission lines.

Two selectable independent LVCMOS compatible clock inputs are available, providing support of redundant clock source systems. The MPC9447 CLK_STOP control is synchronous to the falling edge of the input clock. It allows the start and stop of the output clock signal only in a logic low state, thus eliminating potential output runt pulses. Applying the OE control will force the outputs into high-impedance mode.

All inputs have an internal pull-up or pull-down resistor preventing unused and open inputs from floating. The device supports a 2.5V or 3.3V power supply and an ambient temperature range of -40°C to +85°C. The MPC9447 is pin and function compatible but performance-enhanced to the MPC947.

MPC9447

**LOW VOLTAGE
3.3 V/2.5 V LVCMOS 1:9
CLOCK FANOUT BUFFER**



FA SUFFIX
32-LEAD LQFP PACKAGE
CASE 873A



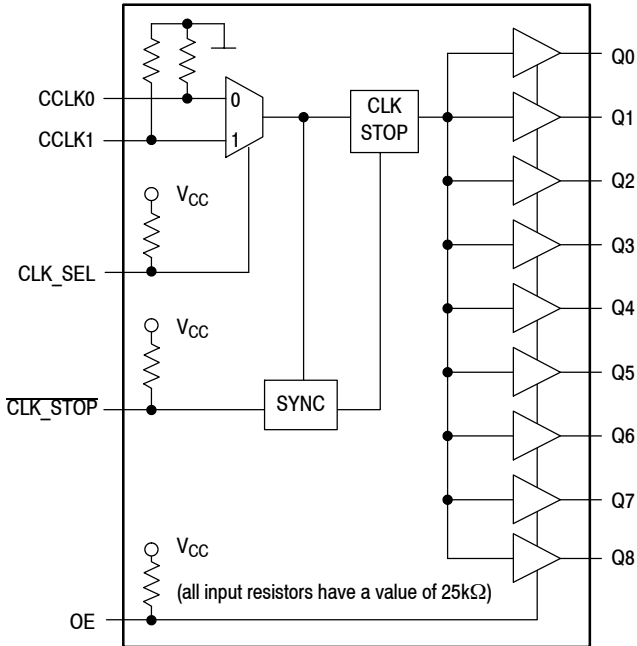

Figure 1. Logic Diagram

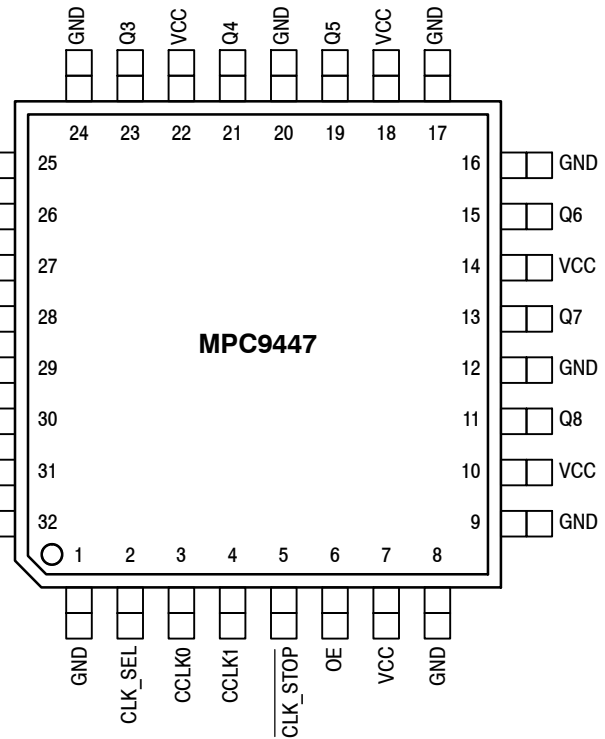

Figure 2. 32-Lead Pinout (Top View)

Table 1. Function Table

Control	Default	0	1
CLK_SEL	1	CLK0 input selected	CLK1 input selected
OE	1	Outputs disabled (high-impedance state) ^a	Outputs enabled
CLK_STOP	1	Outputs synchronously stopped in logic low state	Outputs active

a. OE = 0 will high-impedance tristate all outputs independent on CLK_STOP

Table 2. Pin Configuration

Pin	I/O	Type	Function
CCLK0	Input	LVC MOS	Clock signal input
CCLK1	Input	LVC MOS	Alternative clock signal input
CLK_SEL	Input	LVC MOS	Clock input select
CLK_STOP	Input	LVC MOS	Clock output enable/disable
OE	Input	LVC MOS	Output enable/disable (high-impedance tristate)
Q0-8	Output	LVC MOS	Clock outputs
GND	Supply	Ground	Negative power supply (GND)
VCC	Supply	VCC	Positive power supply for I/O and core. All VCC pins must be connected to the positive power supply for correct operation

Table 3. General Specifications

Symbol	Characteristics	Min	Typ	Max	Unit	Condition
V _{TT}	Output termination voltage		V _{CC} ÷ 2		V	
MM	ESD protection (Machine model)	200			V	
HBM	ESD protection (Human body model)	2000			V	
LU	Latch-up immunity	200			mA	
C _{PD}	Power dissipation capacitance		10		pF	Per output
C _{IN}	Input capacitance		4.0		pF	Inputs

Table 4. Absolute Maximum Ratings^a

Symbol	Characteristics	Min	Max	Unit	Condition
V _{CC}	Supply Voltage	-0.3	3.9	V	
V _{IN}	DC Input Voltage	-0.3	V _{CC} + 0.3	V	
V _{OUT}	DC Output Voltage	-0.3	V _{CC} + 0.3	V	
I _{IN}	DC Input Current		±20	mA	
I _{OUT}	DC Output Current		±50	mA	
T _S	Storage temperature	-65	125	°C	

- a. Absolute maximum continuous ratings are those maximum values beyond which damage to the device may occur. Exposure to these conditions or conditions beyond those indicated may adversely affect device reliability. Functional operation at absolute-maximum-rated conditions is not implied.

Table 5. DC Characteristics (V_{CC} = 3.3V ± 5%, T_A = 40°C to +85°C)

Symbol	Characteristics	Min	Typ	Max	Unit	Condition
V _{IH}	Input High Voltage	2.0		V _{CC} + 0.3	V	LVC MOS
V _{IL}	Input Low Voltage	-0.3		0.8	V	LVC MOS
V _{OH}	Output High Voltage	2.4			V	I _{OH} = -24 mA ^a
V _{OL}	Output Low Voltage			0.55 0.30	V V	I _{OL} = 24 mA I _{OL} = 12 mA
Z _{OUT}	Output Impedance		17		Ω	
I _{IN}	Input Current ^b			±300	μA	V _{IN} = V _{CC} or GND
I _{CCQ}	Maximum Quiescent Supply Current ^c			2.0	mA	All V _{CC} Pins

- a. The MPC9447 is capable of driving 50Ω transmission lines on the incident edge. Each output drives one 50Ω parallel terminated transmission line to a termination voltage of V_{TT}. Alternatively, the device drives up to two 50Ω series terminated transmission lines (for V_{CC}=3.3V).
- b. Inputs have pull-down or pull-up resistors affecting the input current.
- c. I_{CCQ} is the DC current consumption of the device with all outputs open and the input in its default state or open.

Table 6. AC Characteristics (V_{CC} = 3.3V ± 5%, T_A = -40°C to +85°C)^a

Symbol	Characteristics	Min	Typ	Max	Unit	Condition
f _{ref}	Input Frequency	0		350	MHz	
f _{max}	Output Frequency	0		350	MHz	
f _{P,REF}	Reference Input Pulse Width	1.4			ns	
t _r , t _f	CCLK0, CCLK1 Input Rise/Fall Time			1.0 ^b	ns	0.8 to 2.0V
t _{PLH/HL}	Propagation Delay CCLK0 or CCLK1 to any Q	1.3		3.3	ns	
t _{PLZ, HZ}	Output Disable Time			11	ns	
t _{PZL, ZH}	Output Enable Time			11	ns	
t _S	Setup Time CCLK0 or CCLK1 to CLK_STOP ^c	0.0			ns	
t _H	Hold Time CCLK0 or CCLK1 to CLK_STOP ^c	1.0			ns	
t _{sk(O)}	Output-to-Output Skew			150	ps	
t _{sk(PP)}	Device-to-Device Skew			2.0	ns	
t _{SK(P)} DC _Q	Output Pulse Skew ^d Output Duty Cycle	f _Q < 170 MHz	45 50	300 55	ps %	DC _{REF} = 50%
t _r , t _f	Output Rise/Fall Time	0.1		1.0	ns	0.55 to 2.4V
t _{JT(CC)}	Cycle-to-cycle jitter	RMS (1 σ)		TBD	ps	

- a. AC characteristics apply for parallel output termination of 50Ω to V_{TT}.
- b. Violation of the 1.0 ns maximum input rise and fall time limit will affect the device propagation delay, device-to-device skew, reference input pulse width, output duty cycle and maximum frequency specifications.
- c. Setup and hold times are referenced to the falling edge of the selected clock signal input.
- d. Output pulse skew is the absolute difference of the propagation delay times: | t_{PLH} - t_{PHL} |.

Table 7. DC Characteristics ($V_{CC} = 2.5V \pm 5\%$, $T_A = -40^\circ C$ to $+85^\circ C$)

Symbol	Characteristics	Min	Typ	Max	Unit	Condition
V_{IH}	Input High Voltage	1.7		$V_{CC} + 0.3$	V	LVC MOS
V_{IL}	Input Low Voltage	-0.3		0.7	V	LVC MOS
V_{OH}	Output High Voltage	1.8			V	$I_{OH} = -15 \text{ mA}^a$
V_{OL}	Output Low Voltage			0.6	V	$I_{OL} = 15 \text{ mA}$
Z_{OUT}	Output Impedance		19		Ω	
I_{IN}	Input Current ^b			± 300	μA	$V_{IN} = V_{CC}$ or GND
I_{CCQ}	Maximum Quiescent Supply Current ^c			2.0	mA	All V_{CC} Pins

- a. The MPC9447 is capable of driving 50 Ω transmission lines on the incident edge. Each output drives one 50 Ω parallel terminated transmission line to a termination voltage of V_{TT} . Alternatively, the device drives one 50 Ω series terminated transmission lines per output ($V_{CC}=2.5V$).
- b. Inputs have pull-down or pull-up resistors affecting the input current.
- c. I_{CCQ} is the DC current consumption of the device with all outputs open and the input in its default state or open.

Table 8. AC Characteristics ($V_{CC} = 2.5V \pm 5\%$, $T_A = -40^\circ C$ to $+85^\circ C$)^a

Symbol	Characteristics	Min	Typ	Max	Unit	Condition
f_{ref}	Input Frequency	0		350	MHz	
f_{max}	Output frequency	0		350	MHz	
$f_{P,REF}$	Reference Input Pulse Width	1.4			ns	
t_r, t_f	CCLK0, CCLK1 Input Rise/Fall Time			1.0 ^b	ns	0.7 to 1.7V
$t_{PLH/HL}$	Propagation Delay CCLK0 or CCLK1 to any Q	1.7		4.4	ns	
$t_{PLZ, HZ}$	Output Disable Time			11	ns	
$t_{PZL, ZH}$	Output Enable Time			11	ns	
t_s	Setup Time CCLK0 or CCLK1 to CLK_STOP ^c	0.0			ns	
t_H	Hold Time CCLK0 or CCLK1 to CLK_STOP ^c	1.0			ns	
$t_{sk(O)}$	Output-to-Output Skew			150	ps	
$t_{sk(PP)}$	Device-to-Device Skew			2.7	ns	
$t_{sk(P)}$	Output Pulse Skew ^d			200	ps	
DC_Q	Output Duty Cycle $f_Q < 350 \text{ MHz}$	45	50	55	%	$DC_{REF} = 50\%$
t_r, t_f	Output Rise/Fall Time	0.1		1.0	ns	0.6 to 1.8V
$t_{JIT(CC)}$	Cycle-to-cycle jitter RMS (1 σ)		TBD		ps	

- a. AC characteristics apply for parallel output termination of 50 Ω to V_{TT} .
- b. Violation of the 1.0 ns maximum input rise and fall time limit will affect the device propagation delay, device-to-device skew, reference input pulse width, output duty cycle and maximum frequency specifications.
- c. Setup and hold times are referenced to the falling edge of the selected clock signal input.
- d. Output pulse skew is the absolute difference of the propagation delay times: $|t_{PLH} - t_{PHL}|$.

APPLICATION INFORMATION

Figure 3. Output Clock Stop (CLK_STOP) Timing Diagram

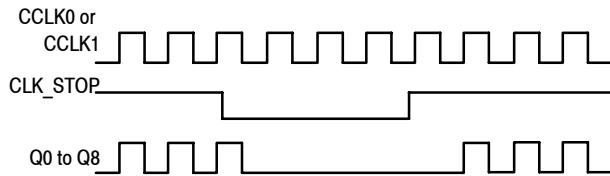

Driving Transmission Lines

The MPC9447 clock driver was designed to drive high speed signals in a terminated transmission line environment. To provide the optimum flexibility to the user, the output drivers were designed to exhibit the lowest impedance possible. With an output impedance of 17Ω (V_{CC}=3.3V), the outputs can drive either parallel or series terminated transmission lines. For more information on transmission lines, the reader is referred to Motorola application note AN1091. In most high performance clock networks, point-to-point distribution of signals is the method of choice. In a point-to-point scheme, either series terminated or parallel terminated transmission lines can be used. The parallel technique terminates the signal at the end of the line with a 50Ω resistance to V_{CC}+2.

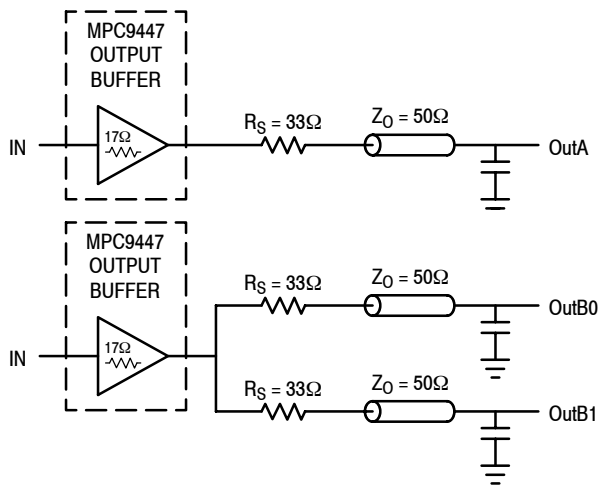

Figure 4. Single versus Dual Transmission Lines

This technique draws a fairly high level of DC current and thus only a single terminated line can be driven by each output of the MPC9447 clock driver. For the series terminated case, however, there is no DC current draw; thus, the outputs can drive multiple series terminated lines. Figure 4 “Single versus Dual Transmission Lines” illustrates an output driving a single series terminated line versus two series terminated lines in parallel. When taken to its extreme, the fanout of the MPC9447 clock driver is effectively doubled due to its capability to drive multiple lines at V_{CC}=3.3V.

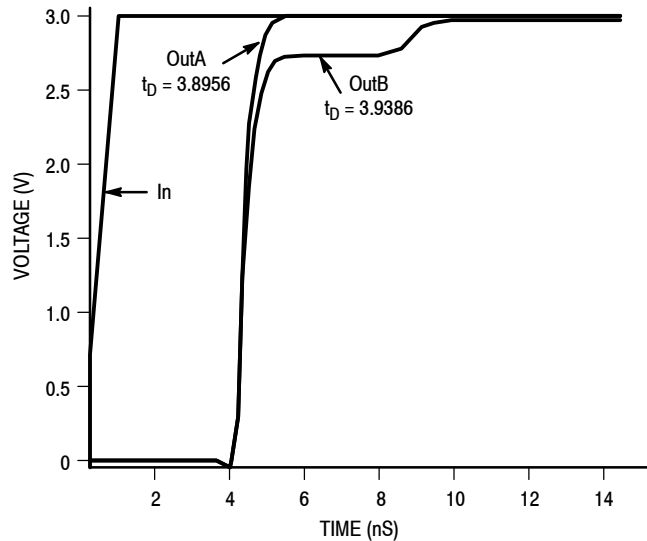

Figure 5. Single versus Dual Line Termination Waveforms

The waveform plots in Figure 5 “Single versus Dual Line Termination Waveforms” show the simulation results of an output driving a single line versus two lines. In both cases, the drive capability of the MPC9447 output buffer is more than sufficient to drive 50Ω transmission lines on the incident edge. Note from the delay measurements in the simulations a delta of only 43ps exists between the two differently loaded outputs. This suggests that the dual line driving need not be used exclusively to maintain the tight output-to-output skew of the MPC9447. The output waveform in Figure 5 “Single versus Dual Line Termination Waveforms” shows a step in the waveform; this step is caused by the impedance mismatch seen looking into the driver. The parallel combination of the 33Ω series resistor plus the output impedance does not match the parallel combination of the line impedances. The voltage wave launched down the two lines will equal:

$$\begin{aligned}
 V_L &= V_S (Z_0 \div (R_S + R_0 + Z_0)) \\
 Z_0 &= 50\Omega \parallel 50\Omega \\
 R_S &= 33\Omega \parallel 33\Omega \\
 R_0 &= 17\Omega \\
 V_L &= 3.0 (25 \div (16.5+17+25) \\
 &= 1.28V
 \end{aligned}$$

At the load end the voltage will double, due to the near unity reflection coefficient, to 2.5V. It will then increment towards the quiescent 3.0V in steps separated by one round trip delay (in this case 4.0ns).

Since this step is well above the threshold region it will not cause any false clock triggering; however, designers may be uncomfortable with unwanted reflections on the line. To better match the impedances when driving multiple lines, the situation in Figure 6 “Optimized Dual Line Termination” should be used. In this case, the series terminating resistors

Freescale Semiconductor, Inc.

are reduced such that when the parallel combination is added to the output buffer impedance the line impedance is perfectly matched.

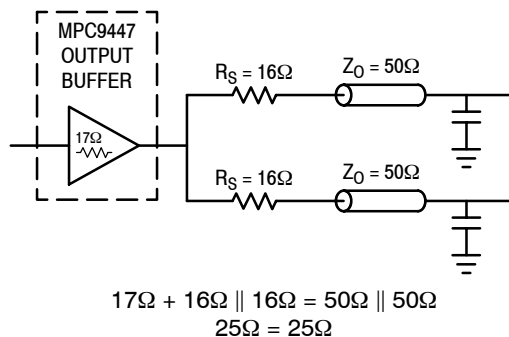

Figure 6. Optimized Dual Line Termination

The Following Figures Illustrate the Measurement Reference for the MPC9447 Clock Driver Circuit

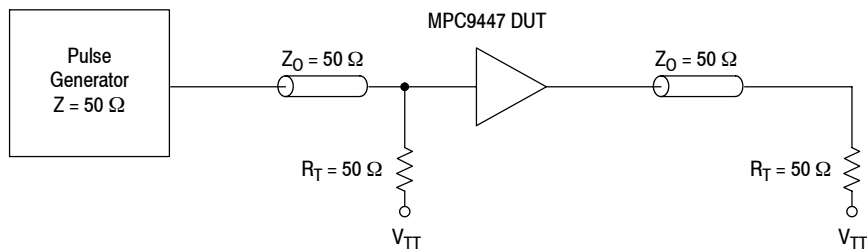

Figure 7. CCLK MPC9447 AC Test Reference for $V_{CC} = 3.3V$ and $V_{CC} = 2.5V$

Freescale Semiconductor, Inc.

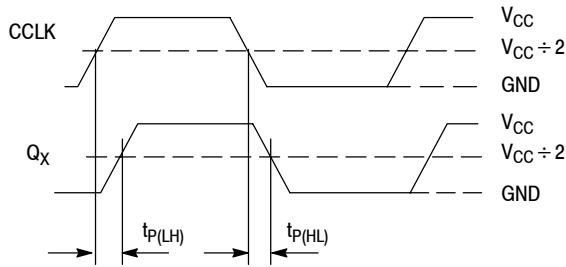
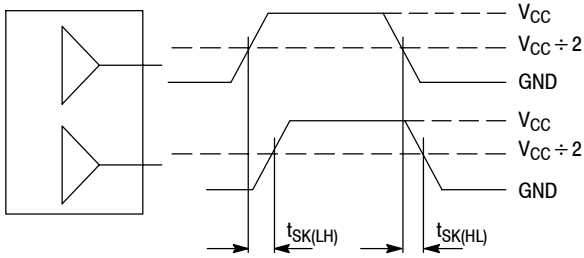
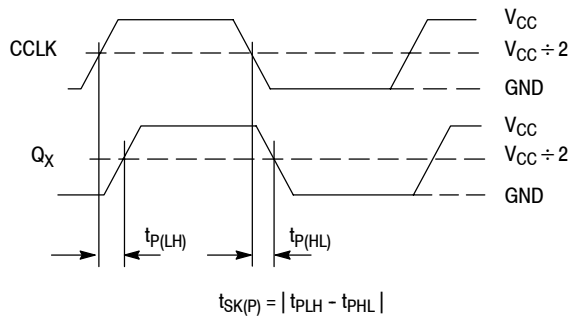

Figure 8. Propagation Delay (t_{PD}) Test Reference



The pin-to-pin skew is defined as the worst case difference in propagation delay between any similar delay path within a single device

Figure 9. Output-to-Output Skew $t_{SK(LH, HL)}$



$$t_{SK(P)} = |t_{PLH} - t_{PHL}|$$

Figure 10. Output Pulse Skew ($t_{SK(P)}$) Test Reference

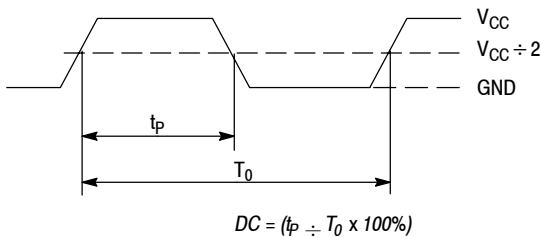

$$DC = (t_p \div T_0 \times 100\%)$$

The time from the output controlled edge to the non-controlled edge, divided by the time between output controlled edges, expressed as a percentage

Figure 11. Output Duty Cycle (DC)

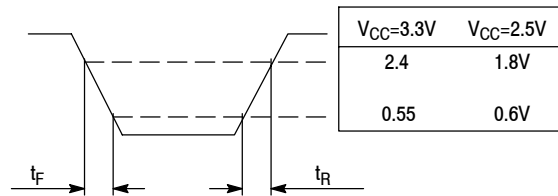
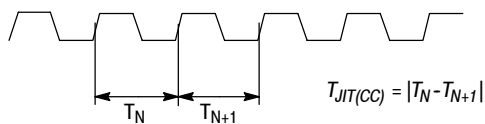

Figure 12. Output Transition Time Test Reference



$$T_{JIT(CC)} = |T_N - T_{N+1}|$$

The variation in cycle time of a signal between adjacent cycles, over a random sample of adjacent cycle pairs

Figure 13. Cycle-to-Cycle Jitter

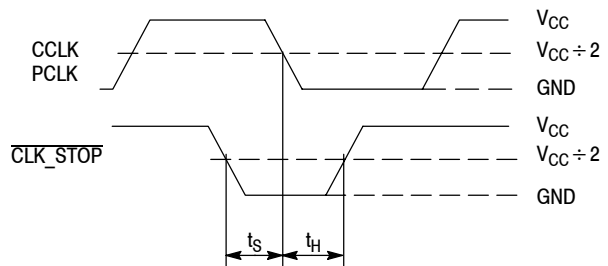
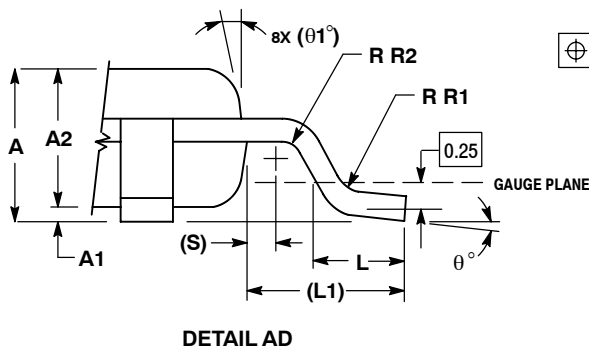
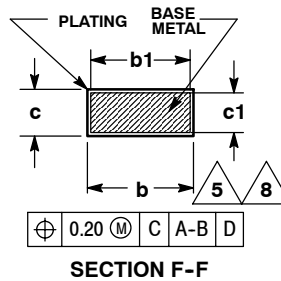
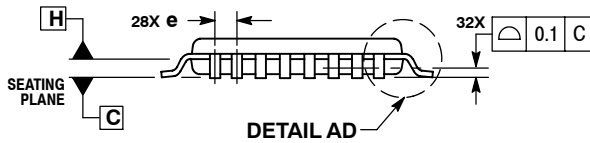
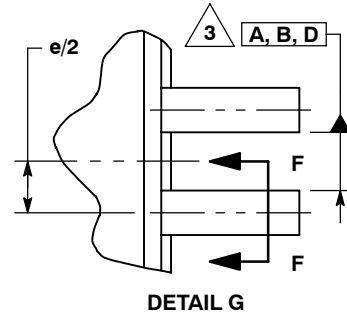
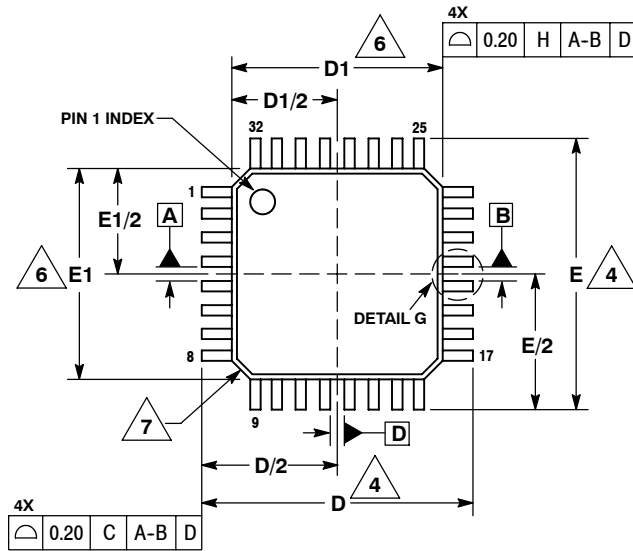

Figure 14. Setup and Hold Time (t_S, t_H) Test Reference

OUTLINE DIMENSIONS

FA SUFFIX
LQFP PACKAGE
CASE 873A-03
ISSUE B



- NOTES:
1. DIMENSIONS ARE IN MILLIMETERS.
 2. INTERPRET DIMENSIONS AND TOLERANCES PER ASME Y14.5M, 1994.
 3. DATUMS A, B, AND D TO BE DETERMINED AT DATUM PLANE H.
 4. DIMENSIONS D AND E TO BE DETERMINED AT SEATING PLANE C.
 5. DIMENSION b DOES NOT INCLUDE DAMBAR PROTRUSION. ALLOWABLE DAMBAR PROTRUSION SHALL NOT CAUSE THE LEAD WIDTH TO EXCEED THE MAXIMUM b DIMENSION BY MORE THAN 0.08-mm. DAMBAR CANNOT BE LOCATED ON THE LOWER RADIUS OR THE FOOT. MINIMUM SPACE BETWEEN PROTRUSION AND ADJACENT LEAD OR PROTRUSION: 0.07-mm.
 6. DIMENSIONS D1 AND E1 DO NOT INCLUDE MOLD PROTRUSION. ALLOWABLE PROTRUSION IS 0.25-mm PER SIDE. D1 AND E1 ARE MAXIMUM PLASTIC BODY SIZE DIMENSIONS INCLUDING MOLD MISMATCH.
 7. EXACT SHAPE OF EACH CORNER IS OPTIONAL.
 8. THESE DIMENSIONS APPLY TO THE FLAT SECTION OF THE LEAD BETWEEN 0.1-mm AND 0.25-mm FROM THE LEAD TIP.

DIM	MILLIMETERS	
	MIN	MAX
A	1.40	1.60
A1	0.05	0.15
A2	1.35	1.45
b	0.30	0.45
b1	0.30	0.40
c	0.09	0.20
c1	0.09	0.16
D	9.00 BSC	
D1	7.00 BSC	
e	0.80 BSC	
E	9.00 BSC	
E1	7.00 BSC	
L	0.50	0.70
L1	1.00	REF
θ	0°	7°
θ1	12° REF	
R1	0.08	0.20
R2	0.08	---
S	0.20 REF	

Freescale Semiconductor, Inc.

NOTES

Freescale Semiconductor, Inc.

NOTES

Freescale Semiconductor, Inc.

NOTES

Freescale Semiconductor, Inc.

Information in this document is provided solely to enable system and software implementers to use Motorola products. There are no express or implied copyright licenses granted hereunder to design or fabricate any integrated circuits or integrated circuits based on the information in this document.

Motorola reserves the right to make changes without further notice to any products herein. Motorola makes no warranty, representation or guarantee regarding the suitability of its products for any particular purpose, nor does Motorola assume any liability arising out of the application or use of any product or circuit, and specifically disclaims any and all liability, including without limitation consequential or incidental damages. "Typical" parameters which may be provided in Motorola data sheets and/or specifications can and do vary in different applications and actual performance may vary over time. All operating parameters, including "Typicals" must be validated for each customer application by customer's technical experts. Motorola does not convey any license under its patent rights nor the rights of others. Motorola products are not designed, intended, or authorized for use as components in systems intended for surgical implant into the body, or other applications intended to support or sustain life, or for any other application in which the failure of the Motorola product could create a situation where personal injury or death may occur. Should Buyer purchase or use Motorola products for any such unintended or unauthorized application, Buyer shall indemnify and hold Motorola and its officers, employees, subsidiaries, affiliates, and distributors harmless against all claims, costs, damages, and expenses, and reasonable attorney fees arising out of, directly or indirectly, any claim of personal injury or death associated with such unintended or unauthorized use, even if such claim alleges that Motorola was negligent regarding the design or manufacture of the part.

MOTOROLA and the Stylized M Logo are registered in the US Patent and Trademark Office. All other product or service names are the property of their respective owners.

© Motorola Inc. 2003

HOW TO REACH US:

USA/EUROPE/LOCATIONS NOT LISTED:

TECHNICAL INFORMATION CENTER:

1-800-521-6274 or 480-768-2130

JAPAN: Motorola Japan Ltd.; SPS, Technical Information Center,
3-20-1, Minami-Azabu, Minato-ku, Tokyo 106-8573 Japan
81-3-3440-3569

ASIA/PACIFIC: Motorola Semiconductors H.K. Ltd.; Silicon Harbour Centre,
2, Dai King Street, Tai Po Industrial Estate, Tai Po, N.T., Hong Kong.
852-26668334

HOME PAGE: <http://motorola.com/semiconductors>



MOTOROLA





**For More Information On This Product,
Go to: www.freescale.com**

MPC9447/D

Looking for pricing, stock, or lifecycle information?

Click below to explore more details on WIN SOURCE:

-  [View MPC9447FA on WIN SOURCE](#)
-  [Freescale Semiconductor - NXP Information](#)

Optimize Your Supply Chain with WIN SOURCE Solutions

-  Global Sourcing Solution
-  Obsolete Management
-  Cost Control Management
-  Shortage Management
-  Alternative Solution
-  Excess Inventory Management