



# 6-Pin DIP Random-Phase Triac Driver Optocoupler (600 Volt Peak)

## MOC3051M, MOC3052M, MOC3053M

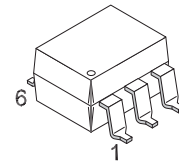
The MOC3051M, MOC3052M and MOC3053M consist of a GaAs infrared emitting diode optically coupled to a non-zero-crossing silicon bilateral AC switch (triac). These devices isolate low voltage logic from 115 V<sub>AC</sub> and 240 V<sub>AC</sub> lines to provide random phase control of high current triacs or thyristors. These devices feature greatly enhanced static dv/dt capability to ensure stable switching performance of inductive loads.

### Features

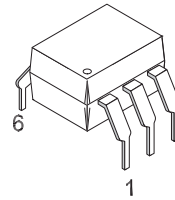
- Excellent I<sub>FT</sub> Stability—IR Emitting Diode Has Low Degradation
- 600 V Peak Blocking Voltage
- Safety and Regulatory Approvals
  - ◆ UL1577, 4,170 V<sub>ACRMS</sub> for 1 Minute
  - ◆ DIN EN/IEC60747-5-5

### Typical Applications

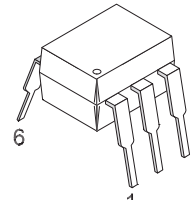
- Solenoid/Valve Controls
- Lamp Ballasts
- Static AC Power Switch
- Interfacing Microprocessors to 115 V<sub>AC</sub> and 240 V<sub>AC</sub> Peripherals
- Solid State Relay
- Incandescent Lamp Dimmers
- Temperature Controls
- Motor Controls



PDIP6  
CASE 646BY

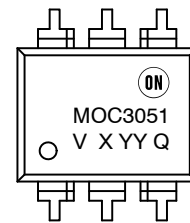


PDIP6  
CASE 646BZ



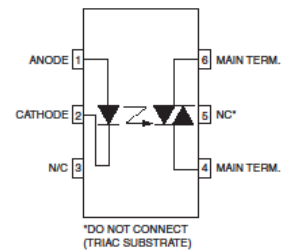
PDIP6  
CASE 646BX

### MARKING DIAGRAM



- |         |                              |
|---------|------------------------------|
| ON      | = ON Semiconductor Logo      |
| MOC3051 | = Device Code                |
| V       | = DIN EN/IEC60747-5-5 Option |
| X       | = One-Digit Year Code        |
| YY      | = Two-Digit Work Week,       |
| Q       | = Assembly Package Code      |

### PIN CONNECTIONS



### ORDERING INFORMATION

See detailed ordering, marking and shipping information on page 9 of this data sheet.

## MOC3051M, MOC3052M, MOC3053M

### SAFETY AND INSULATIONS RATINGS

As per DIN EN/IEC 60747-5-5, this optocoupler is suitable for "safe electrical insulation" only within the safety limit data. Compliance with the safety ratings shall be ensured by means of protective circuits.

Parameter		Characteristics
Installation Classifications per DIN VDE 0110/1.89 Table 1, For Rated Mains Voltage	< 150 V <sub>RMS</sub>	I-IV
	< 300 V <sub>RMS</sub>	I-IV
Climatic Classification		40/85/21
Pollution Degree (DIN VDE 0110/1.89)		2
Comparative Tracking Index		175

Symbol	Parameter	Value	Unit
V <sub>PR</sub>	Input-to-Output Test Voltage, Method A, V <sub>IORM</sub> × 1.6 = V <sub>PR</sub> , Type and Sample Test with t <sub>m</sub> = 10 s, Partial Discharge < 5 pC	1360	V <sub>peak</sub>
	Input-to-Output Test Voltage, Method B, V <sub>IORM</sub> × 1.875 = V <sub>PR</sub> , 100% Production Test with t <sub>m</sub> = 1 s, Partial Discharge < 5 pC	1594	V <sub>peak</sub>
V <sub>IORM</sub>	Maximum Working Insulation Voltage	850	V <sub>peak</sub>
V <sub>IOTM</sub>	Highest Allowable Over-Voltage	6000	V <sub>peak</sub>
	External Creepage	≥ 7	mm
	External Clearance	≥ 7	mm
	External Clearance (for Option TV, 0.4" Lead Spacing)	≥ 10	mm
DTI	Distance Through Insulation (Insulation Thickness)	≥ 0.5	mm
R <sub>IO</sub>	Insulation Resistance at T <sub>S</sub> , V <sub>IO</sub> = 500 V	> 10 <sup>9</sup>	Ω

# MOC3051M, MOC3052M, MOC3053M

**MAXIMUM RATINGS**  $T_A = 25^\circ\text{C}$  unless otherwise specified.

Symbol	Parameter	Value	Unit
<b>TOTAL DEVICE</b>			
$T_{STG}$	Storage Temperature	-40 to +125	$^\circ\text{C}$
$T_{OPR}$	Operating Temperature	-40 to +85	$^\circ\text{C}$
$T_J$	Junction Temperature Range	-40 to +100	$^\circ\text{C}$
$T_{SOL}$	Lead Solder Temperature	260 for 10 seconds	$^\circ\text{C}$
$P_D$	Total Device Power Dissipation at $25^\circ\text{C}$ Ambient	330	mW
	Derate Above $25^\circ\text{C}$	4.4	$\text{mW}/^\circ\text{C}$

## EMITTER

$I_F$	Continuous Forward Current	60	mA
$V_R$	Reverse Voltage	3	V
$P_D$	Total Power Dissipation at $25^\circ\text{C}$ Ambient	100	mW
	Derate Above $25^\circ\text{C}$	1.33	$\text{mW}/^\circ\text{C}$

## DETECTOR

$V_{DRM}$	Off-State Output Terminal Voltage	600	V
$I_{TSM}$	Peak Non-Repetitive Surge Current (Single Cycle 60 Hz Sine Wave)	1	A
$P_D$	Total Power Dissipation at $25^\circ\text{C}$ Ambient	300	mW
	Derate Above $25^\circ\text{C}$	4	$\text{mW}/^\circ\text{C}$

Stresses exceeding those listed in the Maximum Ratings table may damage the device. If any of these limits are exceeded, device functionality should not be assumed, damage may occur and reliability may be affected.

**ELECTRICAL CHARACTERISTICS** ( $T_A = 25^\circ\text{C}$  unless otherwise specified)

### INDIVIDUAL COMPONENT CHARACTERISTICS

Symbol	Parameters	Characteristic	Min	Typ	Max	Unit
--------	------------	----------------	-----	-----	-----	------

#### EMITTER

$V_F$	Input Forward Voltage	$I_F = 10\text{ mA}$		1.18	1.50	V
$I_R$	Reverse Leakage Current	$V_R = 3\text{ V}$		0.05	100	$\mu\text{A}$

#### DETECTOR

$I_{DRM}$	Peak Blocking Current, Either Direction	$V_{DRM} = 600\text{ V}$ , $I_F = 0$ (Note 1)		10	100	nA
$V_{TM}$	Peak On-State Voltage, Either Direction	$I_{TM} = 100\text{ mA peak}$ , $I_F = 0$		2.2	2.5	V
dv/dt	Critical Rate of Rise of Off-State Voltage	$I_F = 0$ , $V_{DRM} = 600\text{ V}$	1000			$\text{V}/\mu\text{s}$

### TRANSFER CHARACTERISTICS

Symbol	DC Characteristic	Test Conditions	Device	Min	Typ	Max	Unit
$I_{FT}$	LED Trigger Current, Either Direction	Main Terminal Voltage = $3\text{ V}$ (Note 2)	MOC3051M			15	mA
			MOC3052M			10	
			MOC3053M			6	
$I_H$	Holding Current, Either Direction		All		540		$\mu\text{A}$

## MOC3051M, MOC3052M, MOC3053M

**ELECTRICAL CHARACTERISTICS** ( $T_A = 25^\circ\text{C}$  unless otherwise specified) (continued)

### INDIVIDUAL COMPONENT CHARACTERISTICS

Symbol	Characteristic	Test Conditions	Min	Typ	Max	Unit
--------	----------------	-----------------	-----	-----	-----	------

#### ISOLATION CHARACTERISTICS

$V_{ISO}$	Input-Output Isolation Voltage (Note 3)	$f = 60 \text{ Hz}, t = 1 \text{ Minute}$	4170			$V_{AC_{RMS}}$
$R_{ISO}$	Isolation Resistance	$V_{I-O} = 500 \text{ V}_{DC}$		$10^{11}$		$\Omega$
$C_{ISO}$	Isolation Capacitance	$V = 0 \text{ V}, f = 1 \text{ MHz}$		0.2		$\text{pF}$

- Test voltage must be applied within  $dv/dt$  rating.
- All devices will trigger at an  $I_F$  value greater than or equal to the maximum  $I_{FT}$  specification. For optimum operation over temperature and lifetime of the device, the LED should be biased with an  $I_F$  that is at least 50% higher than the maximum  $I_{FT}$  specification. The  $I_F$  should not exceed the absolute maximum rating of 60 mA.  
Example: For MOC3052M, the minimum  $I_F$  bias should be  $10 \text{ mA} \times 150\% = 15 \text{ mA}$ .
- Isolation voltage,  $V_{ISO}$ , is an internal device dielectric breakdown rating. For this test, pins 1 and 2 are common, and pins 4, 5 and 6 are common.

TYPICAL CHARACTERISTICS

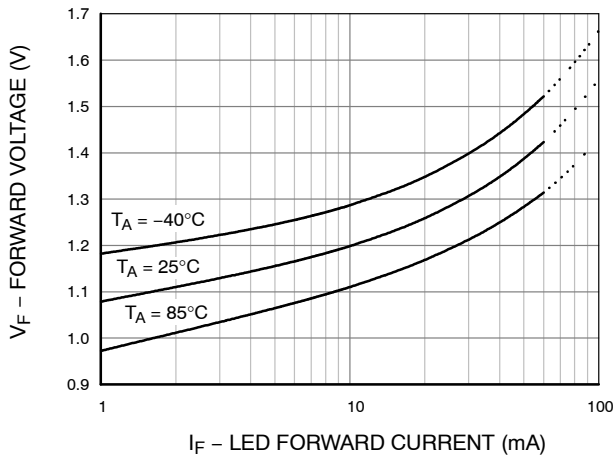


Figure 1. LED Forward Voltage vs. Forward Current

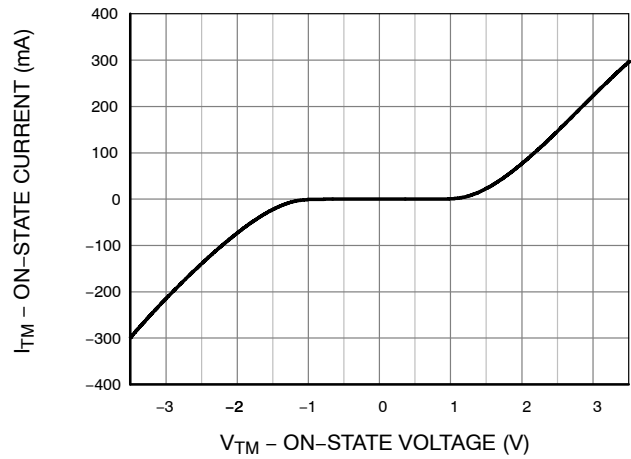


Figure 2. On-State Characteristics

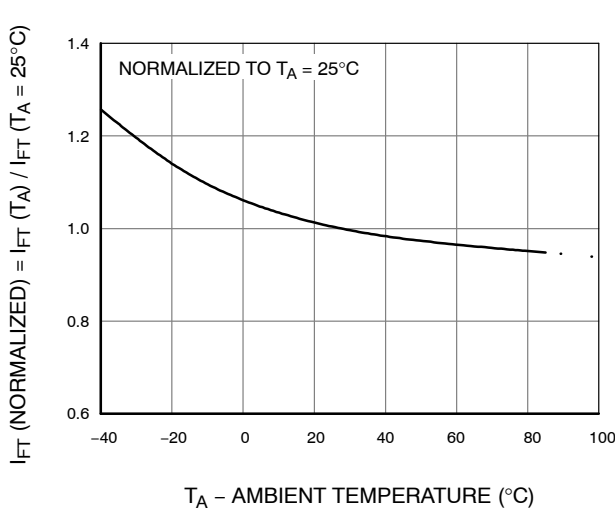


Figure 3. LED Trigger Current vs. Ambient Temperature

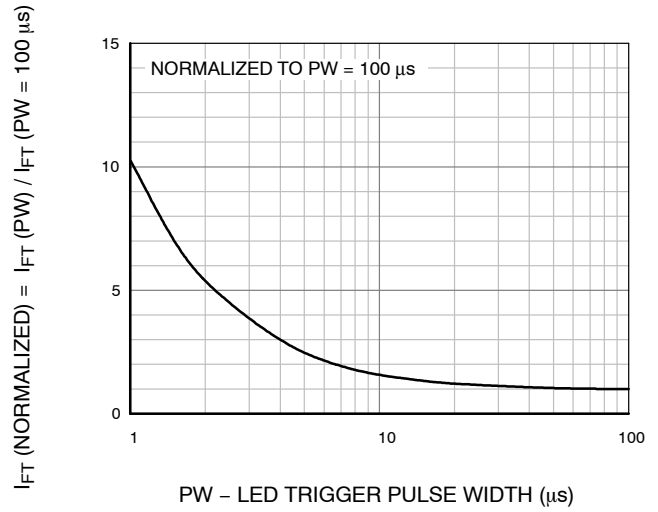


Figure 4. LED Trigger Current vs. LED Pulse Width

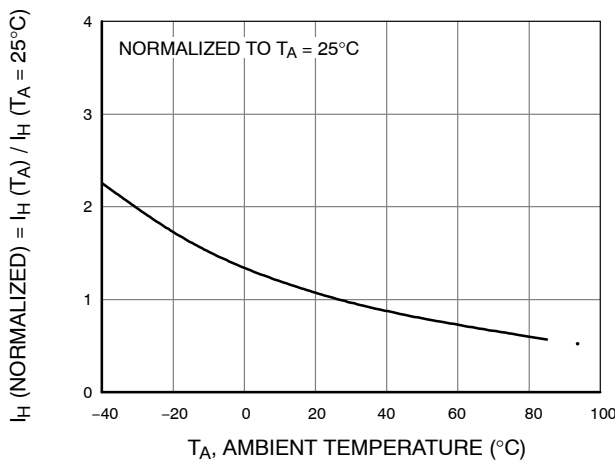


Figure 5. Holding Current vs. Ambient Temperature

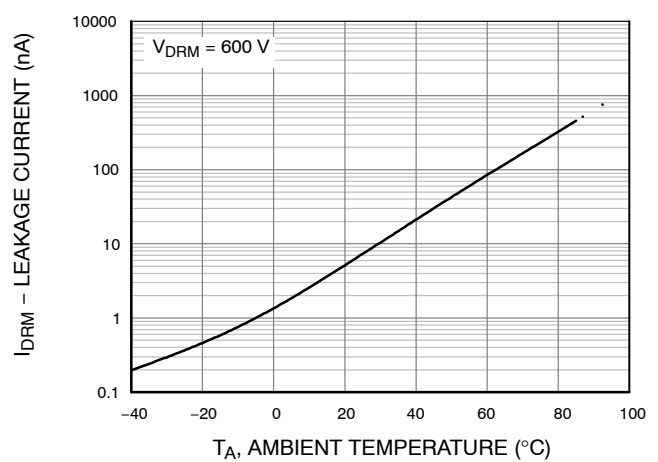


Figure 6. Leakage Current vs. Ambient Temperature

## APPLICATIONS INFORMATION

**Basic Triac Driver Circuit**

The random phase triac drivers MOC3051M, MOC3052M and MOC3053M can allow snubberless operations in applications where load is resistive and the external generated noise in the AC line is below its guaranteed dv/dt withstand capability. For these applications, a snubber circuit is not necessary when a noise insensitive power triac is used. Figure 7 shows the circuit diagram. The triac driver is directly connected to the triac main terminal 2 and a series resistor R which limits the current to the triac driver. Current limiting resistor R must have a minimum value which restricts the current into the driver to maximum 1 A.

The power dissipation of this current limiting resistor and the triac driver is very small because the power triac carries the load current as soon as the current through driver and current limiting resistor reaches the trigger current of the power triac. The switching transition times for the driver is only one micro second and for power triacs typical four micro seconds.

**Triac Driver Circuit for Noisy Environments**

When the transient rate of rise and amplitude are expected to exceed the power triacs and triac drivers maximum ratings a snubber circuit as shown in Figure 8 is recommended. Fast transients are slowed by the R-C snubber and excessive amplitudes are clipped by the Metal Oxide Varistor MOV.

**Triac Driver Circuit for Extremely Noisy Environments**

As specified in the noise standards IEEE472 and IEC255-4.

Industrial control applications do specify a maximum transient noise dv/dt and peak voltage which is super-imposed onto the AC line voltage. In order to pass this environment noise test a modified snubber network as shown in Figure 9 is recommended.

**LED Trigger Current versus Temperature**

Recommended operating LED control current  $I_F$  lies between the guaranteed  $I_{FT}$  and absolute maximum  $I_F$ . Figure 3 shows the increase of the trigger current when the device is expected to operate at an ambient temperature below 25°C. Multiply the datasheet guaranteed  $I_{FT}$  with the normalized  $I_{FT}$  shown on this graph and an allowance for LED degradation over time.

Example:

$$I_{FT} = 10 \text{ mA, LED degradation factor} = 20\%$$

$$I_F \text{ at } -40^\circ\text{C} = 10 \text{ mA} \times 1.25 \times 120\% = 15 \text{ mA}$$

**LED Trigger Current vs. Pulse Width**

Random phase triac drivers are designed to be phase controllable. They may be triggered at any phase angle within the AC sine wave. Phase control may be accomplished by an AC line zero cross detector and a variable pulse delay generator which is synchronized to the zero cross detector. The same task can be accomplished by a microprocessor which is synchronized to the AC zero crossing. The phase controlled trigger current may be a very short pulse which saves energy delivered to the input LED. LED trigger pulse currents shorter than 100  $\mu\text{s}$  must have increased amplitude as shown on Figure 4. This graph shows the dependency of the trigger current  $I_{FT}$  versus the pulse width.  $I_{FT}$  in this graph is normalized in respect to the minimum specified  $I_{FT}$  for static condition, which is specified in the device characteristic. The normalized  $I_{FT}$  has to be multiplied with the devices guaranteed static trigger current.

Example:

$$I_{FT} = 10 \text{ mA, Trigger PW} = 4 \mu\text{s}$$

$$I_F \text{ (pulsed)} = 10 \text{ mA} \times 3 = 30 \text{ mA}$$

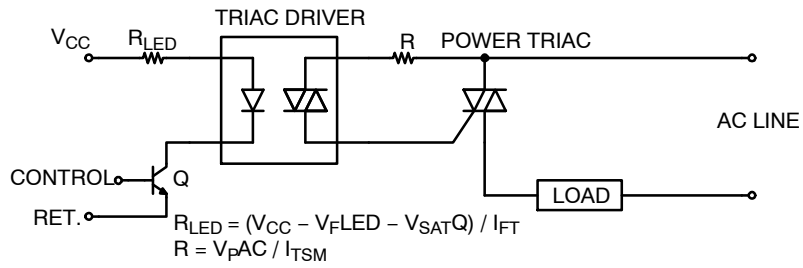
**Minimum LED Off Time in Phase Control Applications**

In phase control applications, one intends to be able to control each AC sine half wave from 0° to 180°. Turn on at 0° means full power and turn on at 180° means zero power. This is not quite possible in reality because triac driver and triac have a fixed turn on time when activated at zero degrees. At a phase control angle close to 180° the driver's turn on pulse at the trailing edge of the AC sine wave must be limited to end 200  $\mu\text{s}$  before AC zero cross as shown in Figure 10. This assures that the triac driver has time to switch off. Shorter times may cause loss of control at the following half cycle.

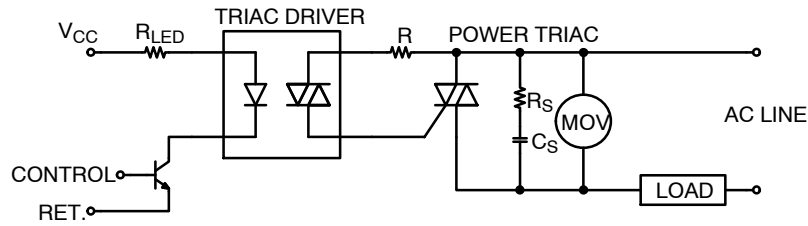
**Static dv/dt**

Critical rate of rise of off-state voltage or static dv/dt is a triac characteristic that rates its ability to prevent false triggering in the event of fast rising line voltage transients when it is in the off-state. When driving a discrete power triac, the triac driver optocoupler switches back to off-state once the power triac is triggered. However, during the commutation of the power triac in application where the load is inductive, both triacs are subjected to fast rising voltages. The static dv/dt rating of the triac driver optocoupler and the commutating dv/dt rating of the power triac must be taken into consideration in snubber circuit design to prevent false triggering and commutation failure.

# MOC3051M, MOC3052M, MOC3053M

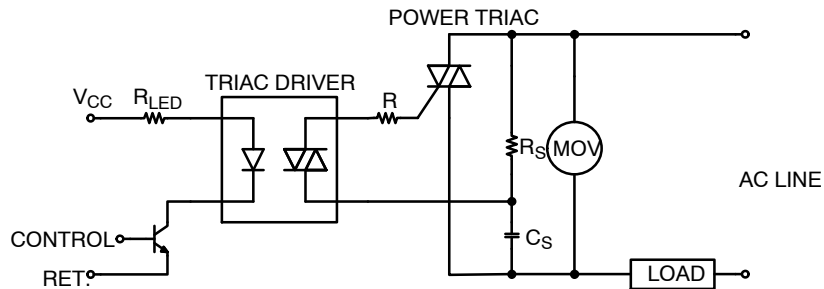


**Figure 7. Basic Driver Circuit**



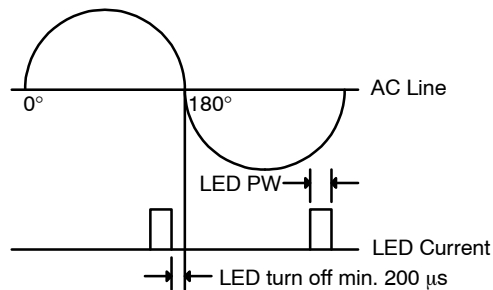
Typical Snubber values  $R_S = 33 \Omega$ ,  $C_S = 0.01 \mu F$   
 MOV (Metal Oxide Varistor) protects power triac and driver from transient overvoltages  $> V_{DRM \max}$

**Figure 8. Triac Driver Circuit for Noisy Environments**



Recommended snubber to pass IEEE472 and IEC255-4 noise tests  
 $R_S = 47 \Omega$ ,  $C_S = 0.01 \mu F$

**Figure 9. Triac Driver Circuit for Extremely Noisy Environments**



**Figure 10. Minimum Time for LED Turn Off to Zero Crossing**

REFLOW PROFILE

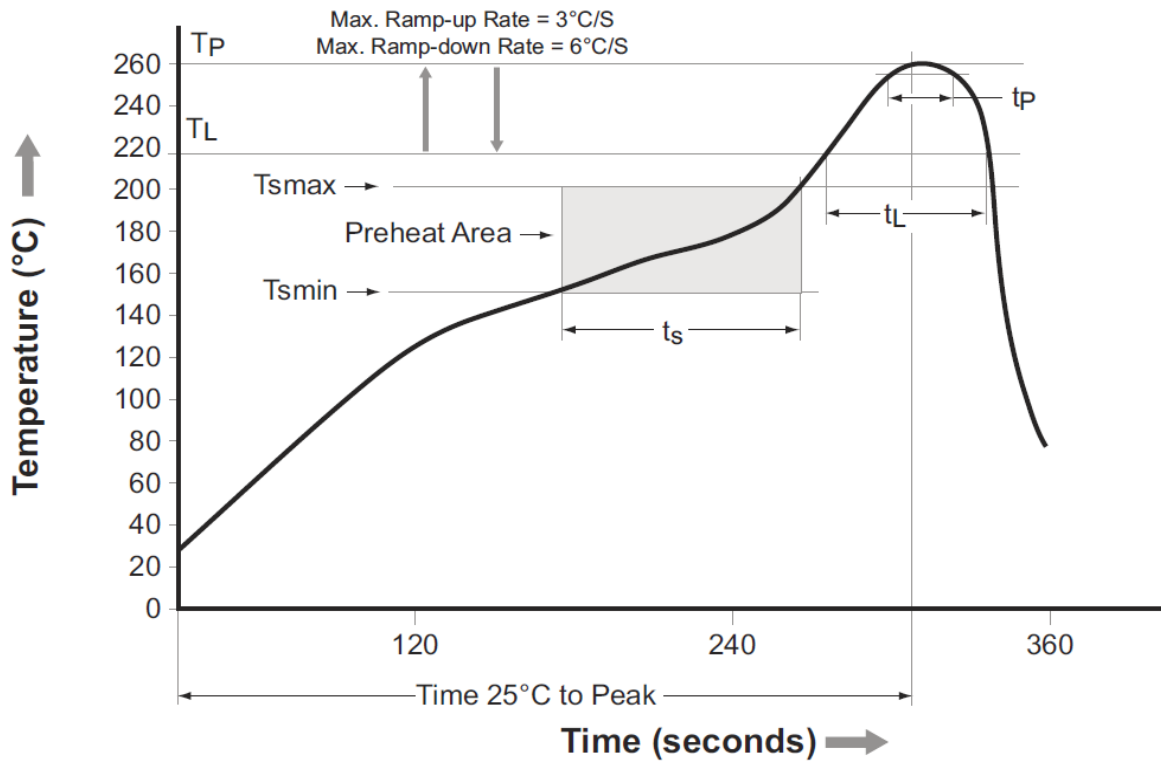


Figure 11. Reflow Profile

Profile Feature	Pb-Free Assembly Profile
Temperature Minimum (T <sub>smin</sub> )	150°C
Temperature Maximum (T <sub>smax</sub> )	200°C
Time (t <sub>s</sub> ) from (T <sub>smin</sub> to T <sub>smax</sub> )	60 seconds to 120 seconds
Ramp-up Rate (T <sub>L</sub> to T <sub>P</sub> )	3°C/second maximum
Liquidous Temperature (T <sub>L</sub> )	217°C
Time (t <sub>L</sub> ) Maintained Above (T <sub>L</sub> )	60 seconds to 150 seconds
Peak Body Package Temperature	260°C +0°C / -5°C
Time (t <sub>P</sub> ) within 5°C of 260°C	30 seconds
Ramp-down Rate (T <sub>P</sub> to T <sub>L</sub> )	6°C/second maximum
Time 25°C to Peak Temperature	8 minutes maximum

## MOC3051M, MOC3052M, MOC3053M

### ORDERING INFORMATION (Note 4)

Device	Package	Shipping
MOC3051M	DIP 6-Pin	Tube (50 Units)
MOC3051SM	SMT 6-Pin (Lead Bend)	Tube (50 Units)
MOC3051SR2M	SMT 6-Pin (Lead Bend)	Tape and Reel (1000 Units)
MOC3051VM	DIP 6-Pin, DIN EN/IEC60747-5-5 Option	Tube (50 Units)
MOC3051SVM	SMT 6-Pin (Lead Bend), DIN EN/IEC60747-5-5 Option	Tube (50 Units)
MOC3051SR2VM	SMT 6-Pin (Lead Bend), DIN EN/IEC60747-5-5 Option	Tape and Reel (1000 Units)
MOC3051TVM	DIP 6-Pin, 0.4" Lead Spacing, DIN EN/IEC60747-5-5 Option	Tube (50 Units)

4. The product orderable part number system listed in this table also applies to the MOC3052M and MOC3053M product families.

# MECHANICAL CASE OUTLINE

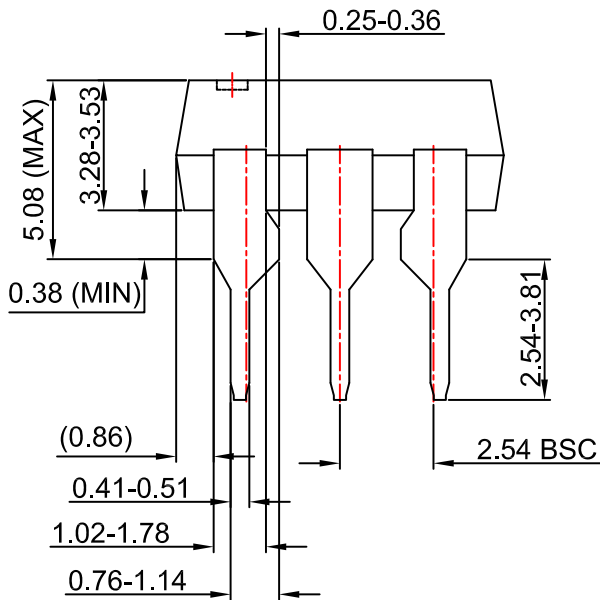
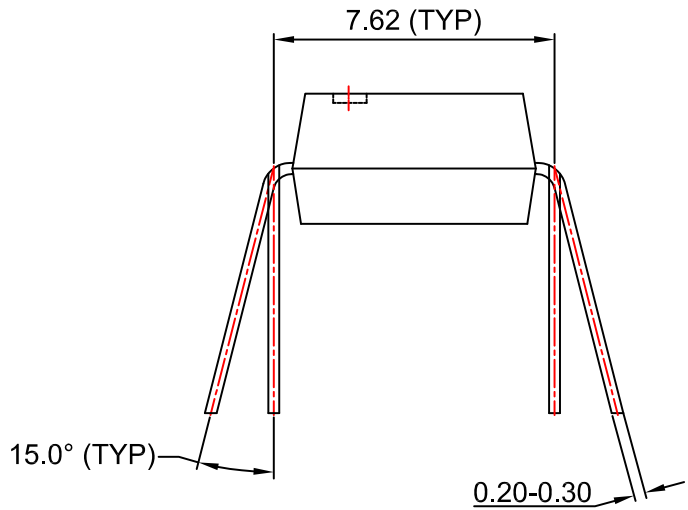
## PACKAGE DIMENSIONS

ON Semiconductor®



PDIP6 8.51x6.35, 2.54P  
CASE 646BX  
ISSUE O

DATE 31 JUL 2016



**NOTES:**

- A) NO STANDARD APPLIES TO THIS PACKAGE.
- B) ALL DIMENSIONS ARE IN MILLIMETERS.
- C) DIMENSIONS ARE EXCLUSIVE OF BURRS, MOLD FLASH, AND TIE BAR EXTRUSION

<b>DOCUMENT NUMBER:</b>	<b>98AON13449G</b>	Electronic versions are uncontrolled except when accessed directly from the Document Repository. Printed versions are uncontrolled except when stamped "CONTROLLED COPY" in red.
<b>DESCRIPTION:</b>	<b>PDIP6 8.51X6.35, 2.54P</b>	<b>PAGE 1 OF 1</b>

ON Semiconductor and are trademarks of Semiconductor Components Industries, LLC dba ON Semiconductor or its subsidiaries in the United States and/or other countries. ON Semiconductor reserves the right to make changes without further notice to any products herein. ON Semiconductor makes no warranty, representation or guarantee regarding the suitability of its products for any particular purpose, nor does ON Semiconductor assume any liability arising out of the application or use of any product or circuit, and specifically disclaims any and all liability, including without limitation special, consequential or incidental damages. ON Semiconductor does not convey any license under its patent rights nor the rights of others.

# MECHANICAL CASE OUTLINE

## PACKAGE DIMENSIONS

ON Semiconductor®



### PDIP6 8.51x6.35, 2.54P CASE 646BY ISSUE A

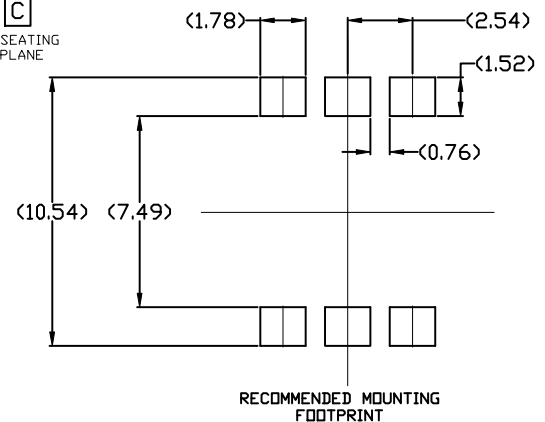
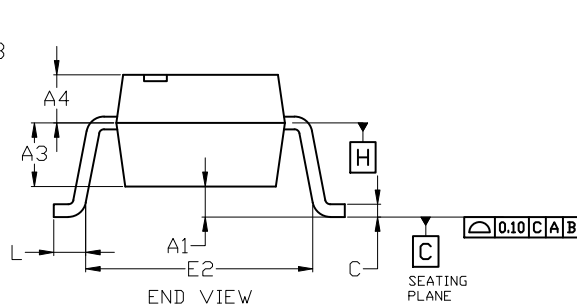
DATE 15 JUL 2019



**NOTES:**

1. DIMENSIONING AND TOLERANCING PER ASME Y14.5M, 2009.
2. CONTROLLING DIMENSION: MILLIMETERS
3. DIMENSIONS A, A1, AND L ARE MEASURED WITH THE PACKAGE SEATED.
4. DIMENSIONS D, D1, AND E1 DO NOT INCLUDE MOLD FLASH OR PROTRUSIONS. MOLD FLASH OR PROTRUSIONS ARE NOT TO EXCEED 2.54mm.
5. PACKAGE CONTOUR IS OPTIONAL (ROUNDED OR SQUARE CORNERS).
6. CENTER LINE OF CORNER LEADS ARE LOCATED BY LOCATING THE CENTER OF FEATURE b2 AND b3.

DIM	MILLIMETERS		
	MIN.	NOM.	MAX.
A	---	---	4.80
A1	0.38	---	---
A2	3.28	3.40	3.53
A3	2.49 REF		
A4	1.89 REF		
b	0.41	0.46	0.51
b1	0.76	0.92	1.14
b2	0.25	0.28	0.36
b3	1.02	1.40	1.78
b4	1.778 REF		
c	0.20	0.25	0.30
D	8.13	8.51	8.89
D1	0.86 REF		
E	6.10	6.35	6.60
E1	8.43	9.17	9.90
E2	8.13 REF		
e	2.54 BSC		
L	0.16	0.52	0.88



For additional information on our Pb-Free strategy and soldering details, please download the ON Semiconductor Soldering and Mounting Techniques Reference Manual, SOLDERM/D.

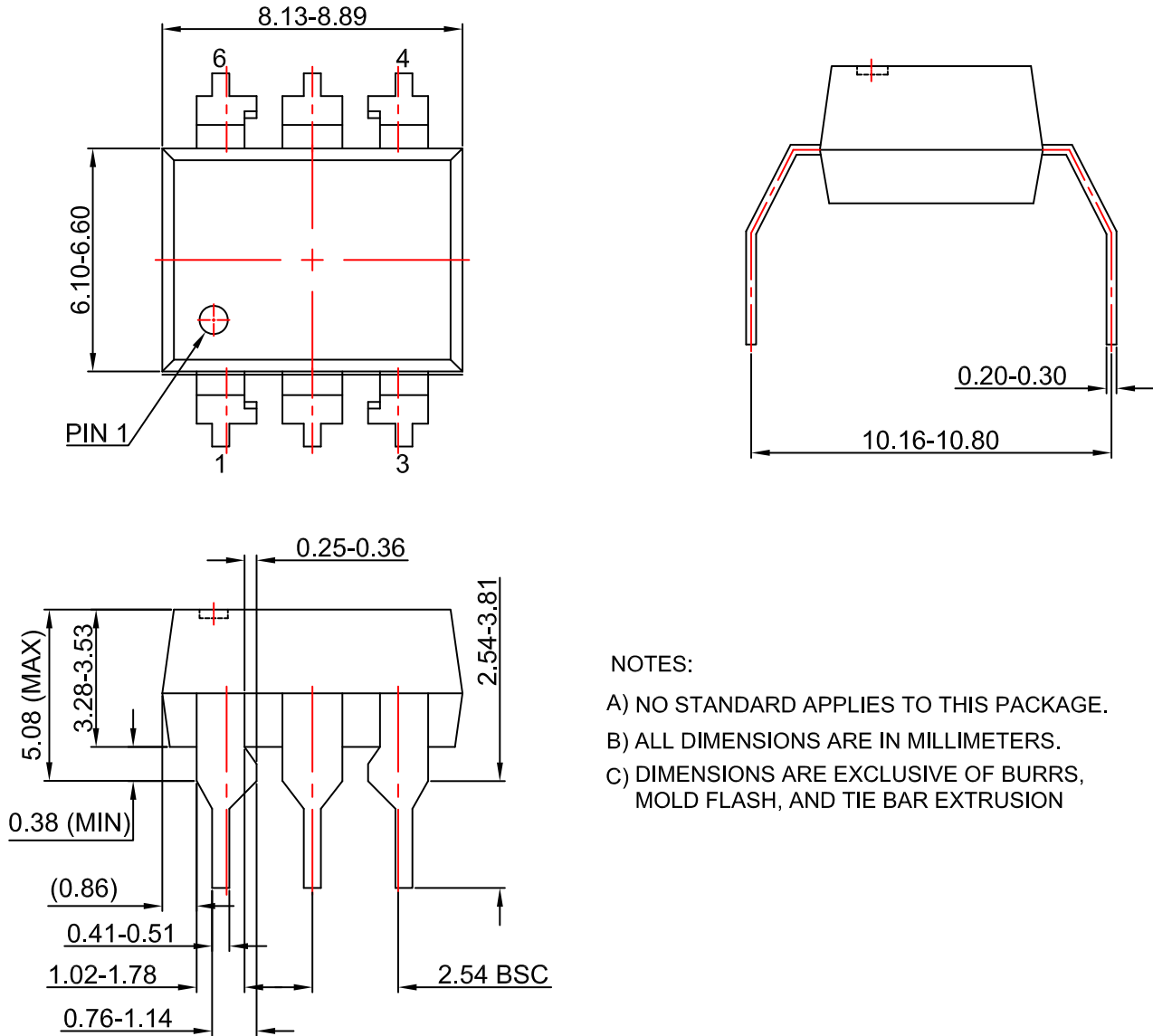
<b>DOCUMENT NUMBER:</b>	<b>98AON13450G</b>	Electronic versions are uncontrolled except when accessed directly from the Document Repository. Printed versions are uncontrolled except when stamped "CONTROLLED COPY" in red.
<b>DESCRIPTION:</b>	<b>PDIP6 8.51x6.35, 2.54P</b>	<b>PAGE 1 OF 1</b>

ON Semiconductor and are trademarks of Semiconductor Components Industries, LLC dba ON Semiconductor or its subsidiaries in the United States and/or other countries. ON Semiconductor reserves the right to make changes without further notice to any products herein. ON Semiconductor makes no warranty, representation or guarantee regarding the suitability of its products for any particular purpose, nor does ON Semiconductor assume any liability arising out of the application or use of any product or circuit, and specifically disclaims any and all liability, including without limitation special, consequential or incidental damages. ON Semiconductor does not convey any license under its patent rights nor the rights of others.

**MECHANICAL CASE OUTLINE**  
**PACKAGE DIMENSIONS**

PDIP6 8.51x6.35, 2.54P  
CASE 646BZ  
ISSUE O

DATE 31 JUL 2016



NOTES:

- A) NO STANDARD APPLIES TO THIS PACKAGE.
- B) ALL DIMENSIONS ARE IN MILLIMETERS.
- C) DIMENSIONS ARE EXCLUSIVE OF BURRS, MOLD FLASH, AND TIE BAR EXTRUSION

<b>DOCUMENT NUMBER:</b>	<b>98AON13451G</b>	Electronic versions are uncontrolled except when accessed directly from the Document Repository. Printed versions are uncontrolled except when stamped "CONTROLLED COPY" in red.
<b>DESCRIPTION:</b>	<b>PDIP6 8.51X6.35, 2.54P</b>	<b>PAGE 1 OF 1</b>

ON Semiconductor and **ON** are trademarks of Semiconductor Components Industries, LLC dba ON Semiconductor or its subsidiaries in the United States and/or other countries. ON Semiconductor reserves the right to make changes without further notice to any products herein. ON Semiconductor makes no warranty, representation or guarantee regarding the suitability of its products for any particular purpose, nor does ON Semiconductor assume any liability arising out of the application or use of any product or circuit, and specifically disclaims any and all liability, including without limitation special, consequential or incidental damages. ON Semiconductor does not convey any license under its patent rights nor the rights of others.

**onsemi**, **Onsemi**, and other names, marks, and brands are registered and/or common law trademarks of Semiconductor Components Industries, LLC dba "**onsemi**" or its affiliates and/or subsidiaries in the United States and/or other countries. **onsemi** owns the rights to a number of patents, trademarks, copyrights, trade secrets, and other intellectual property. A listing of **onsemi**'s product/patent coverage may be accessed at [www.onsemi.com/site/pdf/Patent-Marking.pdf](http://www.onsemi.com/site/pdf/Patent-Marking.pdf). **onsemi** reserves the right to make changes at any time to any products or information herein, without notice. The information herein is provided "as-is" and **onsemi** makes no warranty, representation or guarantee regarding the accuracy of the information, product features, availability, functionality, or suitability of its products for any particular purpose, nor does **onsemi** assume any liability arising out of the application or use of any product or circuit, and specifically disclaims any and all liability, including without limitation special, consequential or incidental damages. Buyer is responsible for its products and applications using **onsemi** products, including compliance with all laws, regulations and safety requirements or standards, regardless of any support or applications information provided by **onsemi**. "Typical" parameters which may be provided in **onsemi** data sheets and/or specifications can and do vary in different applications and actual performance may vary over time. All operating parameters, including "Typicals" must be validated for each customer application by customer's technical experts. **onsemi** does not convey any license under any of its intellectual property rights nor the rights of others. **onsemi** products are not designed, intended, or authorized for use as a critical component in life support systems or any FDA Class 3 medical devices or medical devices with a same or similar classification in a foreign jurisdiction or any devices intended for implantation in the human body. Should Buyer purchase or use **onsemi** products for any such unintended or unauthorized application, Buyer shall indemnify and hold **onsemi** and its officers, employees, subsidiaries, affiliates, and distributors harmless against all claims, costs, damages, and expenses, and reasonable attorney fees arising out of, directly or indirectly, any claim of personal injury or death associated with such unintended or unauthorized use, even if such claim alleges that **onsemi** was negligent regarding the design or manufacture of the part. **onsemi** is an Equal Opportunity/Affirmative Action Employer. This literature is subject to all applicable copyright laws and is not for resale in any manner.

## ADDITIONAL INFORMATION

### TECHNICAL PUBLICATIONS:

Technical Library: [www.onsemi.com/design/resources/technical-documentation](http://www.onsemi.com/design/resources/technical-documentation)  
onsemi Website: [www.onsemi.com](http://www.onsemi.com)

### ONLINE SUPPORT: [www.onsemi.com/support](http://www.onsemi.com/support)

For additional information, please contact your local Sales Representative at [www.onsemi.com/support/sales](http://www.onsemi.com/support/sales)



## Looking for pricing, stock, or lifecycle information?

Click below to explore more details on WIN SOURCE:

- ⊖ [View MOC3051M on WIN SOURCE](#)
- ⊖ [Fairchild/ON Semiconductor Information](#)

## Optimize Your Supply Chain with WIN SOURCE Solutions

- ✓ Global Sourcing Solution
- ✓ Obsolete Management
- ✓ Cost Control Management
- ✓ Shortage Management
- ✓ Alternative Solution
- ✓ Excess Inventory Management