



# Heterojunction Bipolar Transistor (InGaP HBT)

## Broadband High Linearity Amplifier

The MMG3007NT1 is a general purpose amplifier that is internally input and output matched. It is designed for a broad range of Class A, small-signal, high linearity, general purpose applications. It is suitable for applications with frequencies from 0 to 6000 MHz such as cellular, PCS, BWA, WLL, PHS, CATV, VHF, UHF, UMTS and general small-signal RF.

### Features

- Frequency: 0 to 6000 MHz
- P1dB: 16 dBm @ 900 MHz
- Small-Signal Gain: 19 dB @ 900 MHz
- Third Order Output Intercept Point: 30 dBm @ 900 MHz
- Single 5 V Supply
- Internally Matched to 50 Ohms
- Cost-effective SOT-89 Surface Mount Plastic Package
- In Tape and Reel. T1 Suffix = 1,000 Units, 12 mm Tape Width, 7-inch Reel.

**MMG3007NT1**

**0-6000 MHz, 19 dB  
16 dBm  
InGaP HBT GPA**



**SOT-89**

**Table 1. Typical Performance (1)**

| Characteristic                     | Symbol | 900 MHz | 2140 MHz | 3500 MHz | Unit |
|------------------------------------|--------|---------|----------|----------|------|
| Small-Signal Gain (S21)            | $G_p$  | 19      | 16.5     | 14       | dB   |
| Input Return Loss (S11)            | IRL    | -14     | -21      | -21      | dB   |
| Output Return Loss (S22)           | ORL    | -20     | -17      | -25      | dB   |
| Power Output @1dB Compression      | P1dB   | 16      | 15.5     | 16       | dBm  |
| Third Order Output Intercept Point | OIP3   | 30      | 29       | 28.5     | dBm  |

1.  $V_{CC} = 5$  Vdc,  $T_A = 25^\circ\text{C}$ , 50 ohm system.

**Table 2. Maximum Ratings**

| Rating                    | Symbol    | Value       | Unit             |
|---------------------------|-----------|-------------|------------------|
| Supply Voltage            | $V_{CC}$  | 7           | V                |
| Supply Current            | $I_{CC}$  | 250         | mA               |
| RF Input Power            | $P_{in}$  | 10          | dBm              |
| Storage Temperature Range | $T_{stg}$ | -65 to +150 | $^\circ\text{C}$ |
| Junction Temperature      | $T_J$     | 175         | $^\circ\text{C}$ |

**Table 3. Thermal Characteristics**

| Characteristic   | Symbol          | Value (2) | Unit               |
|--|-----------------|-----------|--------------------|
| Thermal Resistance, Junction to Case<br>Case Temperature 86 $^\circ\text{C}$ , 5 Vdc, 47 mA, no RF applied | $R_{\theta JC}$ | 77        | $^\circ\text{C/W}$ |

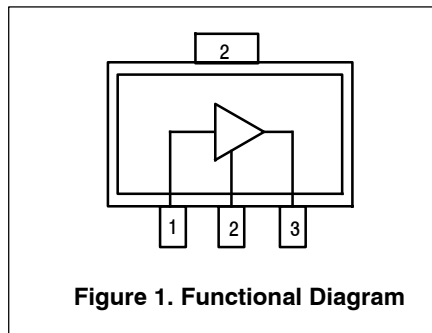
2. Refer to AN1955, *Thermal Measurement Methodology of RF Power Amplifiers*. Go to <http://www.freescale.com/rf>.  
Select Documentation/Application Notes - AN1955.

**Table 4. Electrical Characteristics** ( $V_{CC} = 5 \text{ Vdc}$ , 900 MHz,  $T_A = 25^\circ\text{C}$ , 50 ohm system, in Freescale Application Circuit)

| Characteristic                     | Symbol   | Min | Typ | Max | Unit |
|------------------------------------|----------|-----|-----|-----|------|
| Small-Signal Gain (S21)            | $G_p$    | 18  | 19  | —   | dB   |
| Input Return Loss (S11)            | IRL      | —   | -14 | —   | dB   |
| Output Return Loss (S22)           | ORL      | —   | -20 | —   | dB   |
| Power Output @ 1dB Compression     | P1dB     | —   | 16  | —   | dBm  |
| Third Order Output Intercept Point | OIP3     | —   | 30  | —   | dBm  |
| Noise Figure                       | NF       | —   | 3.8 | —   | dB   |
| Supply Current                     | $I_{CC}$ | 39  | 47  | 55  | mA   |
| Supply Voltage                     | $V_{CC}$ | —   | 5   | —   | V    |

**Table 5. Functional Pin Description**

| Pin Number | Pin Function                 |
|------------|------------------------------|
| 1          | $RF_{in}$                    |
| 2          | Ground                       |
| 3          | $RF_{out}/DC \text{ Supply}$ |



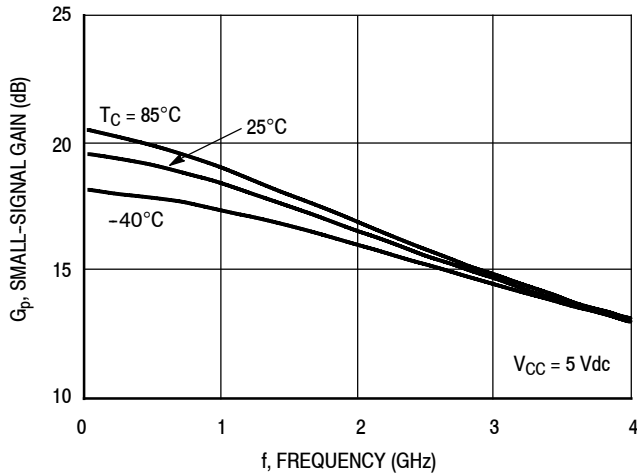
**Table 6. ESD Protection Characteristics**

| Test Methodology                       | Class |
|--|-------|
| Human Body Model (per JESD 22-A114)    | 1A    |
| Machine Model (per EIA/JESD 22-A115)   | A     |
| Charge Device Model (per JESD 22-C101) | IV    |

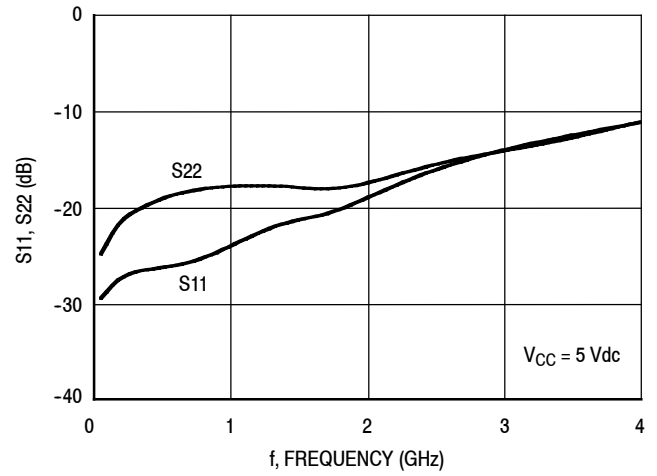
**Table 7. Moisture Sensitivity Level**

| Test Methodology                      | Rating | Package Peak Temperature | Unit             |
|---------------------------------------|--------|--------------------------|------------------|
| Per JESD 22-A113, IPC/JEDEC J-STD-020 | 1      | 260                      | $^\circ\text{C}$ |

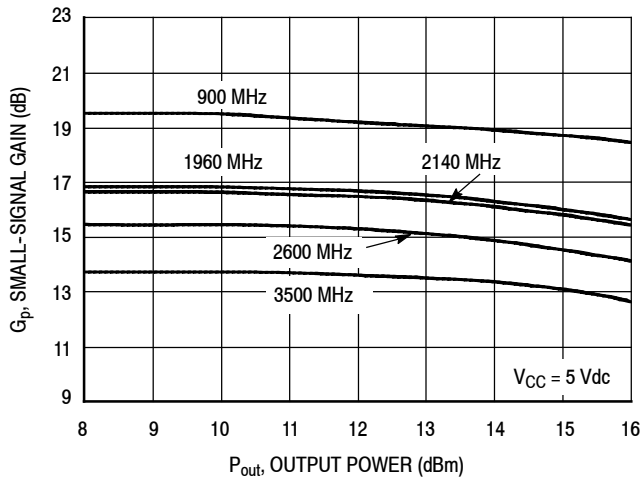
### 50 OHM TYPICAL CHARACTERISTICS



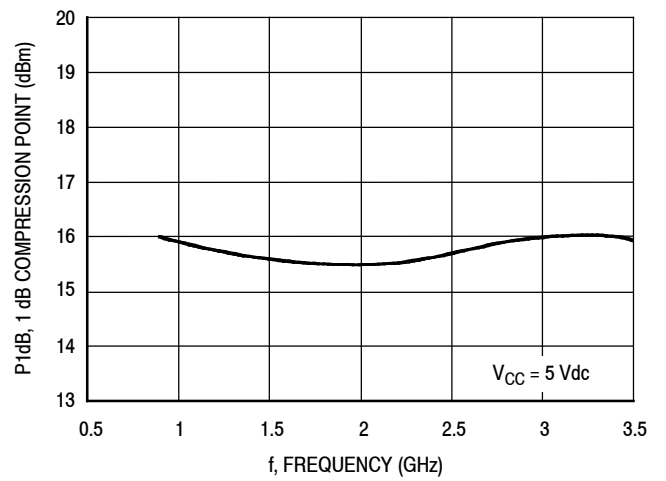
**Figure 2. Small-Signal Gain (S21) versus Frequency**



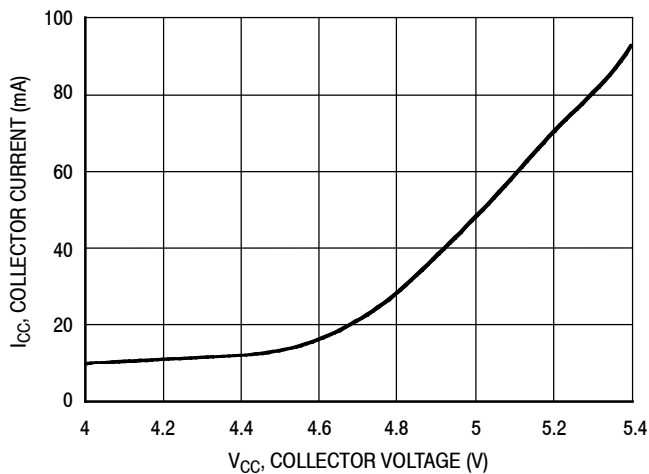
**Figure 3. Input/Output Return Loss versus Frequency**



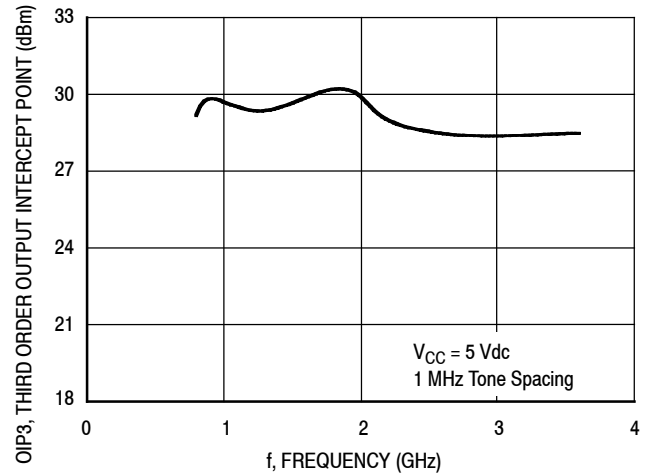
**Figure 4. Small-Signal Gain versus Output Power**



**Figure 5. P1dB versus Frequency**

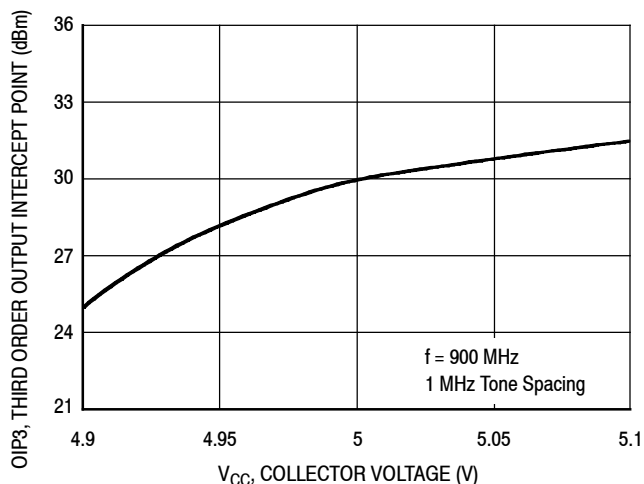


**Figure 6. Collector Current versus Collector Voltage**

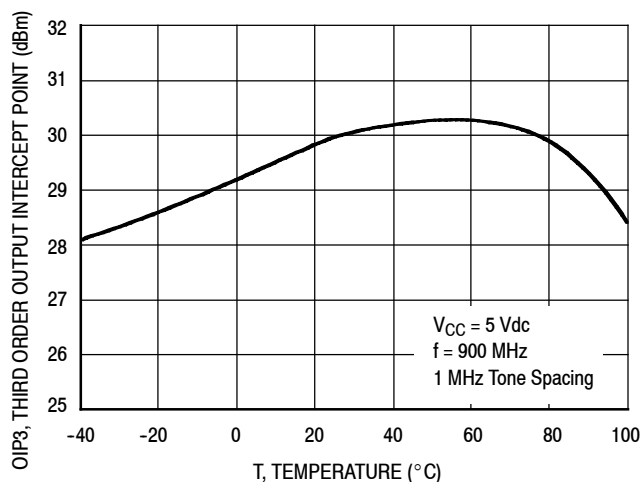


**Figure 7. Third Order Output Intercept Point versus Frequency**

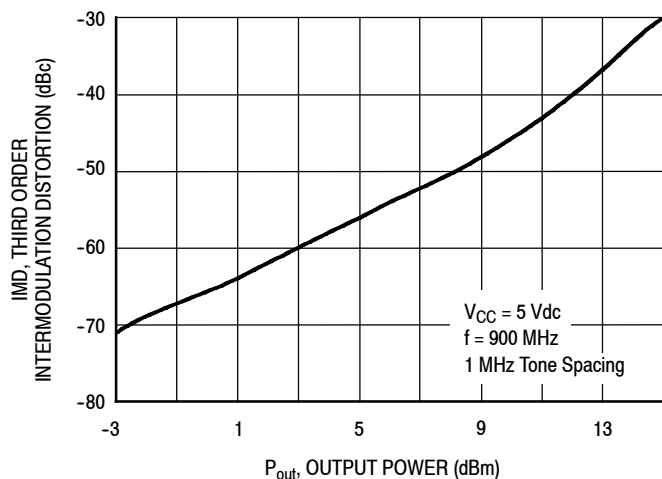
## 50 OHM TYPICAL CHARACTERISTICS



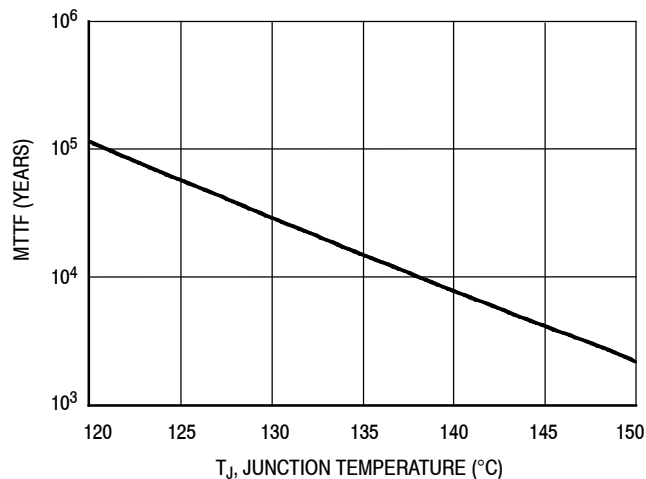
**Figure 8. Third Order Output Intercept Point versus Collector Voltage**



**Figure 9. Third Order Output Intercept Point versus Case Temperature**

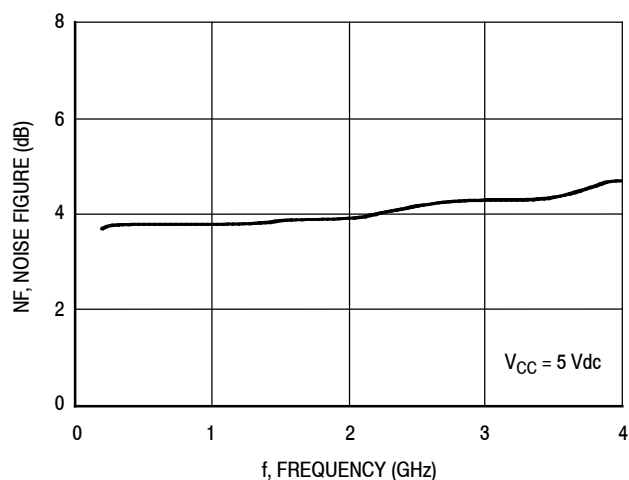


**Figure 10. Third Order Intermodulation Distortion versus Output Power**

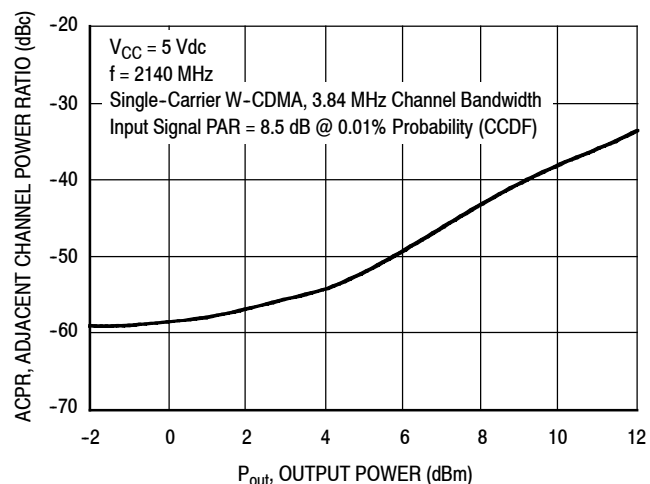


NOTE: The MTTF is calculated with  $V_{CC} = 5 \text{ Vdc}$ ,  $I_{CC} = 47 \text{ mA}$

**Figure 11. MTTF versus Junction Temperature**

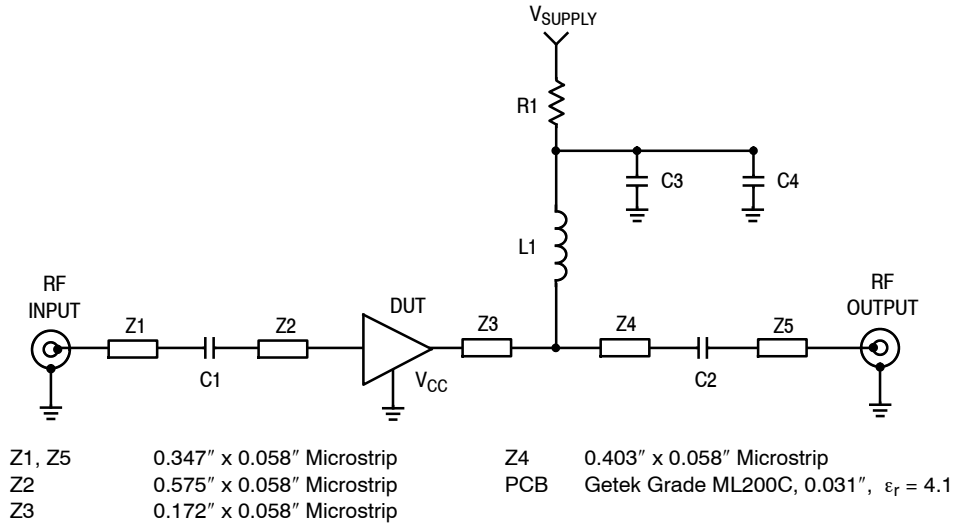


**Figure 12. Noise Figure versus Frequency**

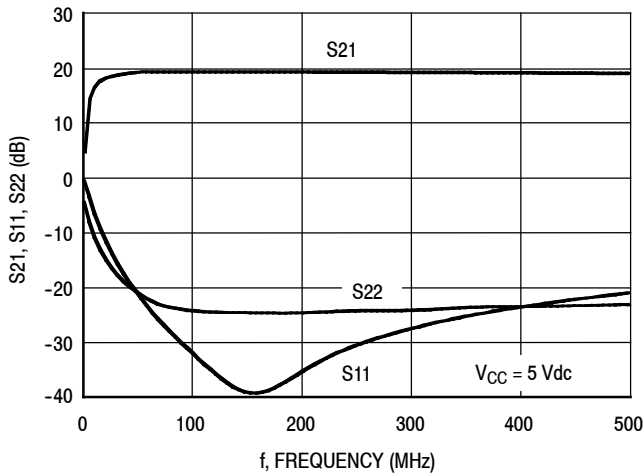


**Figure 13. Single-Carrier W-CDMA Adjacent Channel Power Ratio versus Output Power**

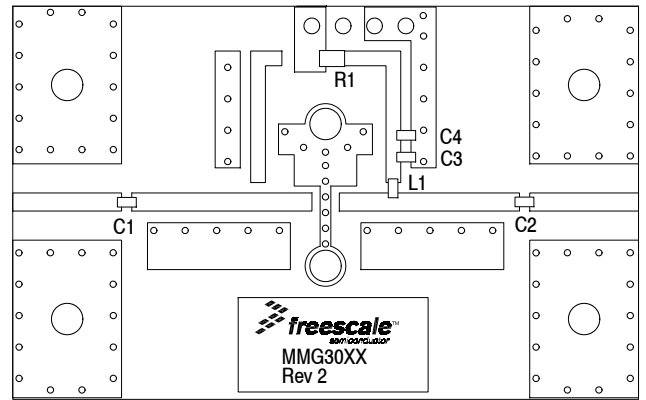
### 50 OHM APPLICATION CIRCUIT: 40-300 MHz



**Figure 14. 50 Ohm Test Circuit Schematic**



**Figure 15. S21, S11 and S22 versus Frequency**

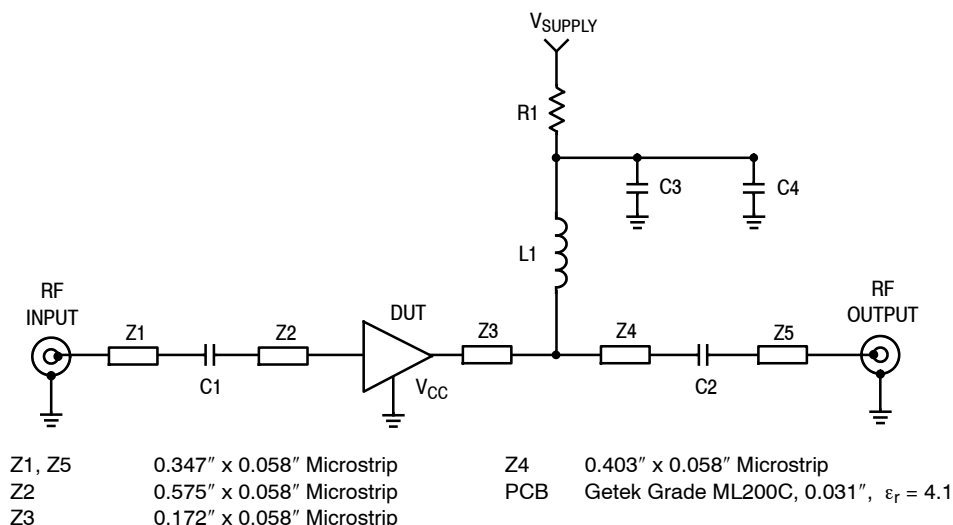


**Figure 16. 50 Ohm Test Circuit Component Layout**

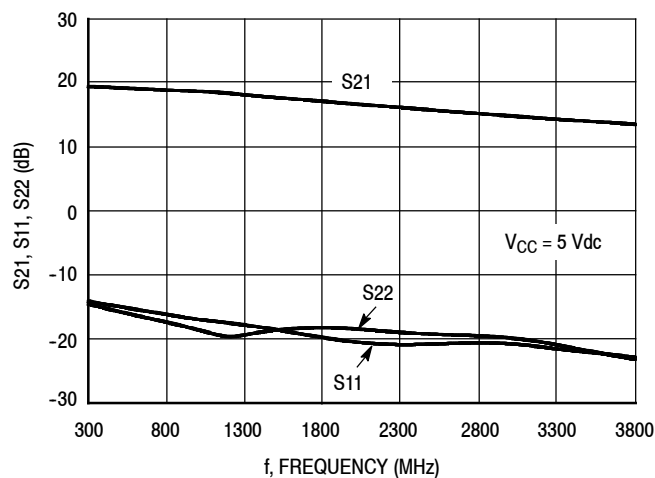
**Table 8. 50 Ohm Test Circuit Component Designations and Values**

| Part       | Description                  | Part Number    | Manufacturer |
|------------|------------------------------|----------------|--------------|
| C1, C2, C3 | 0.01 $\mu$ F Chip Capacitors | C0603C103J5RAC | Kemet        |
| C4         | 1000 pF Chip Capacitor       | C0603C102J5RAC | Kemet        |
| L1         | 470 nH Chip Inductor         | BK2125HM471-T  | Taiyo Yuden  |
| R1         | 0 $\Omega$ Chip Resistor     | ERJ3GEY0R00V   | Panasonic    |

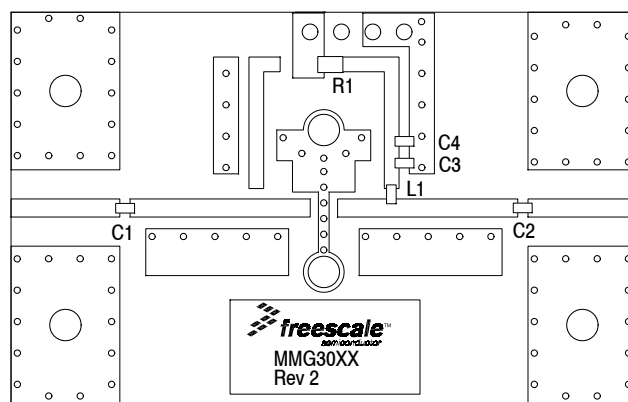
### 50 OHM APPLICATION CIRCUIT: 300-3600 MHz



**Figure 17. 50 Ohm Test Circuit Schematic**



**Figure 18. S21, S11 and S22 versus Frequency**



**Figure 19. 50 Ohm Test Circuit Component Layout**

**Table 9. 50 Ohm Test Circuit Component Designations and Values**

| Part   | Description                 | Part Number    | Manufacturer |
|--------|-----------------------------|----------------|--------------|
| C1, C2 | 150 pF Chip Capacitors      | C0603C151J5RAC | Kemet        |
| C3     | 0.01 $\mu$ F Chip Capacitor | C0603C103J5RAC | Kemet        |
| C4     | 1000 pF Chip Capacitor      | C0603C102J5RAC | Kemet        |
| L1     | 56 nH Chip Inductor         | HK160856NJ-T   | Taiyo Yuden  |
| R1     | 0 $\Omega$ Chip Resistor    | ERJ3GEY0R00V   | Panasonic    |

## 50 OHM TYPICAL CHARACTERISTICS

**Table 10. Common Emitter S-Parameters** ( $V_{CC} = 5 \text{ Vdc}$ ,  $T_A = 25^\circ\text{C}$ , 50 Ohm System)

| f<br>MHz | S <sub>11</sub> |         | S <sub>21</sub> |         | S <sub>12</sub> |         | S <sub>22</sub> |          |
|----------|-----------------|---------|-----------------|---------|-----------------|---------|-----------------|----------|
|          | S <sub>11</sub> | ∠ φ     | S <sub>21</sub> | ∠ φ     | S <sub>12</sub> | ∠ φ     | S <sub>22</sub> | ∠ φ      |
| 100      | 0.03698         | 162.744 | 9.488476        | 175.169 | 0.07218         | -0.406  | 0.06601         | -6.062   |
| 150      | 0.0413          | 161.759 | 9.431009        | 172.714 | 0.073936        | -0.163  | 0.07813         | -11.706  |
| 200      | 0.04475         | 159.333 | 9.37615         | 169.547 | 0.07479         | -1.111  | 0.089562        | -18.834  |
| 250      | 0.046352        | 159.222 | 9.34083         | 167.191 | 0.0744          | -1.219  | 0.09748         | -25.724  |
| 300      | 0.048403        | 155.469 | 9.29558         | 164.704 | 0.07458         | -1.237  | 0.10124         | -32.775  |
| 350      | 0.05            | 151.008 | 9.26495         | 162.138 | 0.07444         | -1.639  | 0.10466         | -36.946  |
| 400      | 0.0499          | 147.696 | 9.21219         | 159.65  | 0.07473         | -1.957  | 0.10811         | -41.977  |
| 450      | 0.04922         | 144.11  | 9.16094         | 157.234 | 0.07499         | -2.087  | 0.11164         | -46.631  |
| 500      | 0.04838         | 141.343 | 9.10787         | 154.702 | 0.07517         | -2.464  | 0.11391         | -50.846  |
| 550      | 0.04902         | 137.521 | 9.04991         | 152.326 | 0.07536         | -2.681  | 0.11765         | -55.096  |
| 600      | 0.04911         | 134.226 | 8.98419         | 149.922 | 0.07567         | -2.89   | 0.11998         | -59.312  |
| 650      | 0.0497          | 130.851 | 8.91939         | 147.525 | 0.07584         | -3.227  | 0.12163         | -63.354  |
| 700      | 0.05086         | 127.93  | 8.85099         | 145.201 | 0.07618         | -3.577  | 0.12411         | -67.411  |
| 750      | 0.05247         | 124.848 | 8.78068         | 142.838 | 0.07642         | -3.81   | 0.12586         | -71.332  |
| 800      | 0.05441         | 122.43  | 8.70765         | 140.522 | 0.07659         | -4.138  | 0.12711         | -75.244  |
| 850      | 0.05624         | 120.786 | 8.63598         | 138.198 | 0.07702         | -4.463  | 0.12825         | -79.297  |
| 900      | 0.05818         | 118.791 | 8.5575          | 135.918 | 0.0774          | -4.812  | 0.12922         | -83.181  |
| 950      | 0.06054         | 117.037 | 8.47718         | 133.677 | 0.07767         | -5.244  | 0.13            | -87.373  |
| 1000     | 0.06284         | 115.852 | 8.40286         | 131.466 | 0.07806         | -5.558  | 0.13077         | -91.474  |
| 1050     | 0.06676         | 114.603 | 8.31905         | 129.243 | 0.07848         | -5.948  | 0.13124         | -95.143  |
| 1100     | 0.06962         | 113.845 | 8.23305         | 127.045 | 0.07874         | -6.3    | 0.13158         | -99.674  |
| 1150     | 0.07142         | 114.019 | 8.14799         | 124.84  | 0.07912         | -6.731  | 0.13134         | -104.011 |
| 1200     | 0.07473         | 113.644 | 8.05859         | 122.666 | 0.07962         | -7.194  | 0.13136         | -108.404 |
| 1250     | 0.07822         | 113.329 | 7.97269         | 120.536 | 0.07992         | -7.652  | 0.13147         | -112.847 |
| 1300     | 0.08137         | 113.158 | 7.89042         | 118.443 | 0.08035         | -8.105  | 0.1318          | -117.291 |
| 1350     | 0.08501         | 112.83  | 7.80455         | 116.374 | 0.08077         | -8.476  | 0.13257         | -121.809 |
| 1400     | 0.085621        | 112.341 | 7.71693         | 114.349 | 0.08135         | -8.943  | 0.13274         | -126.4   |
| 1450     | 0.08691         | 112.503 | 7.62844         | 112.301 | 0.08168         | -9.492  | 0.130129        | -130.945 |
| 1500     | 0.087447        | 112.516 | 7.55444         | 110.29  | 0.08226         | -9.966  | 0.127178        | -132.429 |
| 1550     | 0.088958        | 110.702 | 7.46781         | 108.325 | 0.08275         | -10.605 | 0.125783        | -135.873 |
| 1600     | 0.088598        | 108.771 | 7.39276         | 106.371 | 0.08326         | -11.086 | 0.12282         | -139.82  |
| 1650     | 0.089575        | 107.354 | 7.30109         | 104.406 | 0.08366         | -11.654 | 0.1228          | -142.9   |
| 1700     | 0.09071         | 105.666 | 7.2314          | 102.488 | 0.0841          | -12.158 | 0.12308         | -146.866 |
| 1750     | 0.0938          | 104.101 | 7.15066         | 100.592 | 0.08459         | -12.724 | 0.12424         | -150.805 |
| 1800     | 0.097           | 102.621 | 7.07137         | 98.688  | 0.0851          | -13.319 | 0.12564         | -154.586 |
| 1850     | 0.10094         | 101.285 | 6.98725         | 96.791  | 0.08555         | -13.926 | 0.12718         | -158.448 |
| 1900     | 0.10562         | 99.475  | 6.90714         | 94.976  | 0.08607         | -14.507 | 0.12895         | -162.5   |
| 1950     | 0.10927         | 97.823  | 6.83262         | 93.117  | 0.0865          | -15.154 | 0.13127         | -166.07  |
| 2000     | 0.11424         | 96.4    | 6.75439         | 91.288  | 0.08691         | -15.771 | 0.13415         | -169.355 |
| 2050     | 0.11811         | 94.531  | 6.67977         | 89.43   | 0.08733         | -16.325 | 0.13706         | -172.886 |
| 2100     | 0.12221         | 93.106  | 6.60249         | 87.648  | 0.08781         | -17.024 | 0.14095         | -175.782 |
| 2150     | 0.12585         | 91.879  | 6.53055         | 85.88   | 0.0884          | -17.685 | 0.14488         | -179.155 |
| 2200     | 0.13197         | 90.391  | 6.44752         | 84.16   | 0.08868         | -18.268 | 0.14844         | 178.18   |
| 2250     | 0.13625         | 88.624  | 6.37451         | 82.389  | 0.08924         | -18.993 | 0.15223         | 175.153  |

(continued)

**MMG3007NT1**

## 50 OHM TYPICAL CHARACTERISTICS

**Table 10. Common Emitter S-Parameters** ( $V_{CC} = 5 \text{ Vdc}$ ,  $T_A = 25^\circ\text{C}$ , 50 Ohm System) (continued)

| f<br>MHz | S <sub>11</sub> |        | S <sub>21</sub> |        | S <sub>12</sub> |         | S <sub>22</sub> |         |
|----------|-----------------|--------|-----------------|--------|-----------------|---------|-----------------|---------|
|          | S <sub>11</sub> | ∠ φ    | S <sub>21</sub> | ∠ φ    | S <sub>12</sub> | ∠ φ     | S <sub>22</sub> | ∠ φ     |
| 2300     | 0.14158         | 86.951 | 6.30389         | 80.681 | 0.08971         | -19.632 | 0.15572         | 172.537 |
| 2350     | 0.14606         | 85.398 | 6.23166         | 78.989 | 0.09007         | -20.321 | 0.15962         | 170.114 |
| 2400     | 0.15065         | 83.971 | 6.16179         | 77.288 | 0.09053         | -20.98  | 0.16279         | 167.517 |
| 2450     | 0.15511         | 82.457 | 6.09153         | 75.581 | 0.09088         | -21.711 | 0.16641         | 165.072 |
| 2500     | 0.15948         | 80.991 | 6.02115         | 73.906 | 0.09142         | -22.394 | 0.16996         | 162.826 |
| 2550     | 0.16385         | 79.722 | 5.95767         | 72.273 | 0.09177         | -23.024 | 0.17342         | 160.459 |
| 2600     | 0.16854         | 78.35  | 5.89249         | 70.612 | 0.09216         | -23.702 | 0.17676         | 157.989 |
| 2650     | 0.17283         | 76.864 | 5.82721         | 68.994 | 0.09255         | -24.506 | 0.17953         | 155.564 |
| 2700     | 0.17698         | 75.562 | 5.76221         | 67.358 | 0.09293         | -25.194 | 0.18268         | 153.165 |
| 2750     | 0.18126         | 74.328 | 5.70193         | 65.748 | 0.09333         | -25.926 | 0.18543         | 150.629 |
| 2800     | 0.1858          | 72.976 | 5.64062         | 64.155 | 0.09391         | -26.671 | 0.18837         | 148.259 |
| 2850     | 0.18957         | 71.773 | 5.58104         | 62.533 | 0.09428         | -27.402 | 0.19087         | 145.593 |
| 2900     | 0.19403         | 70.699 | 5.52616         | 60.973 | 0.09472         | -28.203 | 0.19395         | 143.044 |
| 2950     | 0.19798         | 69.575 | 5.46422         | 59.362 | 0.09518         | -28.947 | 0.19629         | 140.485 |
| 3000     | 0.20132         | 68.53  | 5.41159         | 57.778 | 0.09558         | -29.733 | 0.19941         | 137.461 |
| 3050     | 0.20676         | 67.445 | 5.36032         | 56.228 | 0.09592         | -30.462 | 0.20221         | 135.101 |
| 3100     | 0.21059         | 66.347 | 5.30349         | 54.654 | 0.09653         | -31.263 | 0.20477         | 132.383 |
| 3150     | 0.21388         | 65.517 | 5.25234         | 53.104 | 0.09687         | -32.035 | 0.20796         | 129.58  |
| 3200     | 0.21774         | 64.628 | 5.20188         | 51.53  | 0.09729         | -32.944 | 0.21083         | 126.913 |
| 3250     | 0.22229         | 63.76  | 5.15023         | 49.962 | 0.09771         | -33.702 | 0.21442         | 124.314 |
| 3300     | 0.22492         | 62.653 | 5.10104         | 48.396 | 0.09812         | -34.531 | 0.21656         | 121.289 |
| 3350     | 0.2287          | 61.882 | 5.05108         | 46.866 | 0.09855         | -35.414 | 0.22001         | 118.535 |
| 3400     | 0.23228         | 60.924 | 5.00022         | 45.297 | 0.099           | -36.284 | 0.2241          | 115.888 |
| 3450     | 0.2365          | 60.161 | 4.95117         | 43.756 | 0.09926         | -37.17  | 0.22826         | 113.148 |
| 3500     | 0.24039         | 59.326 | 4.90461         | 42.216 | 0.09948         | -38.046 | 0.23275         | 110.547 |
| 3550     | 0.24401         | 58.457 | 4.85739         | 40.692 | 0.09979         | -38.943 | 0.23669         | 107.983 |
| 3600     | 0.24834         | 57.659 | 4.80824         | 39.155 | 0.10008         | -39.768 | 0.24177         | 105.495 |

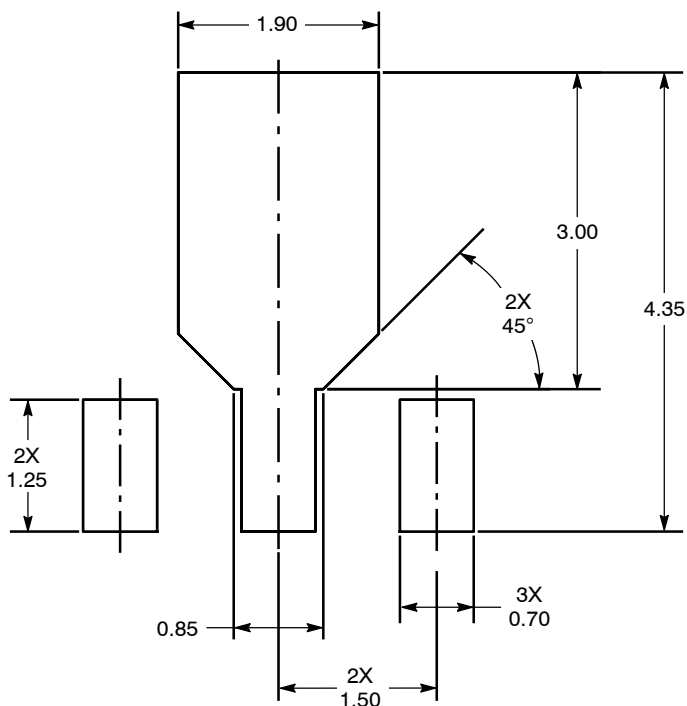


Figure 20. PCB Pad Layout for SOT-89A

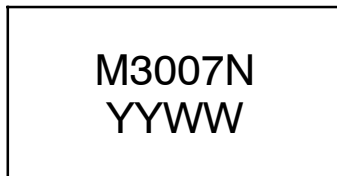
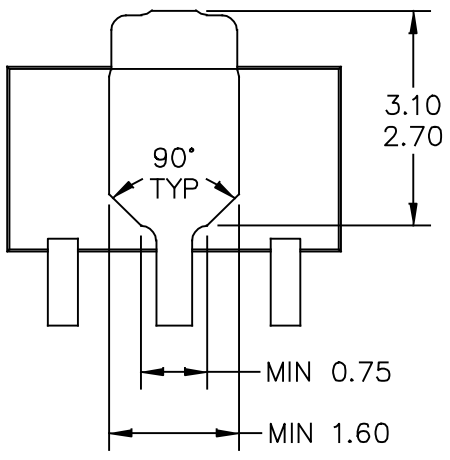


Figure 21. Product Marking





BOTTOM VIEW

|   |                          |                            |  |
|---|--------------------------|----------------------------|--|
| © FREESCALE SEMICONDUCTOR, INC.<br>ALL RIGHTS RESERVED.   | MECHANICAL OUTLINE       | PRINT VERSION NOT TO SCALE |  |
| TITLE:<br>SOT-89A, 3 LEAD,<br>4.5 X 2.5 PKG, 1.5 MM PITCH | DOCUMENT NO: 98ASA00241D | REV: 0                     |  |
|   | CASE NUMBER: 2142-01     | 15 JUL 2010                |  |
|   | STANDARD: NON-JEDEC      |                            |  |

NOTES:

1. DIMENSIONING AND TOLERANCING PER ASME Y14.5M – 1994.

2. ALL DIMENSIONS ARE IN MILLIMETERS.

3. DIMENSIONS DOES NOT INCLUDE MOLD FLASH. PROTRUSIONS OR GATE BURRS. MOLD FLASH, PROTRUSIONS OR GATE BURRS SHALL NOT EXCEED 0.5 MM PER END. DIMENSION DOES NOT INCLUDE INTERLEAD FLASH OR PROTRUSION. INTERLEAD FLASH OR PROTRUSION SHALL NOT EXCEED 0.5 MM PER SIDE.

4. DIMENSION ARE DETERMINED AT THE OUTMOST EXTREMES OF THE PLASTIC BODY EXCLUSIVE OF MOLD FLASH, TIE BAR BURRS, GATE BURRS AND INTERLEAD FLASH, BUT INCLUDING ANY MISMATCH BETWEEN THE TOP AND BOTTOM OF THE PLASTIC BODY.

5. TERMINAL NUMBERS ARE SHOWN FOR REFERENCE ONLY.

|   |                          |                            |  |
|---|--------------------------|----------------------------|--|
| © FREESCALE SEMICONDUCTOR, INC.<br>ALL RIGHTS RESERVED.   | MECHANICAL OUTLINE       | PRINT VERSION NOT TO SCALE |  |
| TITLE:<br>SOT-89A, 3 LEAD,<br>4.5 X 2.5 PKG, 1.5 MM PITCH | DOCUMENT NO: 98ASA00241D | REV: 0                     |  |
|   | CASE NUMBER: 2142-01     | 15 JUL 2010                |  |
|   | STANDARD: NON-JEDEC      |                            |  |

Refer to the following resources to aid your design process.

**Application Notes**

- AN1955: Thermal Measurement Methodology of RF Power Amplifiers
- AN3100: General Purpose Amplifier and MMIC Biasing

**Software**

- .s2p File

**Development Tools**

- Printed Circuit Boards

For Software and Tools, do a Part Number search at <http://www.freescale.com>, and select the “Part Number” link. Go to Software & Tools on the part’s Product Summary page to download the respective tool.

**FAILURE ANALYSIS**

At this time, because of the physical characteristics of the part, failure analysis is limited to electrical signature analysis. In cases where Freescale is contractually obligated to perform failure analysis (FA) services, full FA may be performed by third party vendors with moderate success. For updates contact your local Freescale Sales Office.

**REVISION HISTORY**

The following table summarizes revisions to this document.

| Revision | Date       | Description  |
|----------|------------|--|
| 3        | Mar. 2007  | <ul style="list-style-type: none"> <li>• Corrected and updated Part Numbers in Tables 8 and 9, Component Designations and Values, to RoHS compliant part numbers, pp. 6, 7</li> </ul>  |
| 4        | July 2007  | <ul style="list-style-type: none"> <li>• Replaced Case Outline 1514-01 with 1514-02, Issue D, pp. 1, 11-13. Case updated to add missing dimension for Pin 1 and Pin 3.</li> </ul>  |
| 5        | Mar. 2008  | <ul style="list-style-type: none"> <li>• Removed Footnote 2, Continuous voltage and current applied to device, from Table 2, Maximum Ratings, p. 1</li> <li>• Corrected Fig. 13, Single-Carrier W-CDMA Adjacent Channel Power Ratio versus Output Power y-axis (ACPR) unit of measure to dBc, p. 5</li> <li>• Corrected S-Parameter table frequency column label to read “MHz” versus “GHz” and corrected frequency values from GHz to MHz, pp. 8, 9</li> </ul>  |
| 6        | Feb. 2012  | <ul style="list-style-type: none"> <li>• Corrected temperature at which Theta<sub>JC</sub> is measured from 25°C to 86°C and added “no RF applied” to Thermal Characteristics table to indicate that thermal characterization is performed under DC test with no RF signal applied, p. 1</li> <li>• Table 6, ESD Protection Characteristics, removed the word “Minimum” after the ESD class rating. ESD ratings are characterized during new product development but are not 100% tested during production. ESD ratings provided in the data sheet are intended to be used as a guideline when handling ESD sensitive devices, p. 3</li> <li>• Removed I<sub>CC</sub> bias callout from applicable graphs and Table 10, Common Emitter S-Parameters heading as bias is not a controlled value, pp. 4-9</li> <li>• Added .s2p File availability to Product Software and Printed Circuit Boards to Development Tools, p. 14</li> </ul> |
| 7        | Sept. 2014 | <ul style="list-style-type: none"> <li>• Replaced the PCB Pad Layout drawing, the package image and mechanical outline for Case 1514-02 (SOT-89) with Case 2142-01 (SOT-89) as a result of the device transfer from a Freescale wafer fab to an external GaAs wafer fab and new assembly site. The new assembly and test site’s SOT-89 package has slight dimensional differences, pp. 1, 9-12. Refer to PCN13337, <i>GaAs Fab Transfer</i>.</li> <li>• Table 2, Maximum Ratings: updated Junction Temperature from 150°C to 175°C to reflect recent test results of the device, p. 1</li> <li>• Added Fig. 21, Product Marking, p. 9</li> <li>• Added Failure Analysis information, p. 13</li> </ul>  |

### ***How to Reach Us:***

**Home Page:**  
[freescale.com](http://freescale.com)

**Web Support:**  
[freescale.com/support](http://freescale.com/support)

Information in this document is provided solely to enable system and software implementers to use Freescale products. There are no express or implied copyright licenses granted hereunder to design or fabricate any integrated circuits based on the information in this document.

Freescale reserves the right to make changes without further notice to any products herein. Freescale makes no warranty, representation, or guarantee regarding the suitability of its products for any particular purpose, nor does Freescale assume any liability arising out of the application or use of any product or circuit, and specifically disclaims any and all liability, including without limitation consequential or incidental damages. "Typical" parameters that may be provided in Freescale data sheets and/or specifications can and do vary in different applications, and actual performance may vary over time. All operating parameters, including "typicals," must be validated for each customer application by customer's technical experts. Freescale does not convey any license under its patent rights nor the rights of others. Freescale sells products pursuant to standard terms and conditions of sale, which can be found at the following address: [freescale.com/SalesTermsandConditions](http://freescale.com/SalesTermsandConditions).

Freescale and the Freescale logo are trademarks of Freescale Semiconductor, Inc., Reg. U.S. Pat. & Tm. Off. All other product or service names are the property of their respective owners.

© 2005–2008, 2012, 2014 Freescale Semiconductor, Inc.

## Looking for pricing, stock, or lifecycle information?

Click below to explore more details on WIN SOURCE:

- ⊖ [View MMG3007NT1 on WIN SOURCE](#)
- ⊖ [Freescale Semiconductor - NXP Information](#)

## Optimize Your Supply Chain with WIN SOURCE Solutions

- ✓ Global Sourcing Solution
- ✓ Obsolete Management
- ✓ Cost Control Management
- ✓ Shortage Management
- ✓ Alternative Solution
- ✓ Excess Inventory Management