



Is Now Part of



ON Semiconductor®

To learn more about ON Semiconductor, please visit our website at
www.onsemi.com

Please note: As part of the Fairchild Semiconductor integration, some of the Fairchild orderable part numbers will need to change in order to meet ON Semiconductor's system requirements. Since the ON Semiconductor product management systems do not have the ability to manage part nomenclature that utilizes an underscore (_), the underscore (_) in the Fairchild part numbers will be changed to a dash (-). This document may contain device numbers with an underscore (_). Please check the ON Semiconductor website to verify the updated device numbers. The most current and up-to-date ordering information can be found at www.onsemi.com. Please email any questions regarding the system integration to Fairchild_questions@onsemi.com.

ON Semiconductor and the ON Semiconductor logo are trademarks of Semiconductor Components Industries, LLC dba ON Semiconductor or its subsidiaries in the United States and/or other countries. ON Semiconductor owns the rights to a number of patents, trademarks, copyrights, trade secrets, and other intellectual property. A listing of ON Semiconductor's product/patent coverage may be accessed at www.onsemi.com/site/pdf/Patent-Marking.pdf. ON Semiconductor reserves the right to make changes without further notice to any products herein. ON Semiconductor makes no warranty, representation or guarantee regarding the suitability of its products for any particular purpose, nor does ON Semiconductor assume any liability arising out of the application or use of any product or circuit, and specifically disclaims any and all liability, including without limitation special, consequential or incidental damages. Buyer is responsible for its products and applications using ON Semiconductor products, including compliance with all laws, regulations and safety requirements or standards, regardless of any support or applications information provided by ON Semiconductor. "Typical" parameters which may be provided in ON Semiconductor data sheets and/or specifications can and do vary in different applications and actual performance may vary over time. All operating parameters, including "Typicals" must be validated for each customer application by customer's technical experts. ON Semiconductor does not convey any license under its patent rights nor the rights of others. ON Semiconductor products are not designed, intended, or authorized for use as a critical component in life support systems or any FDA Class 3 medical devices or medical devices with a same or similar classification in a foreign jurisdiction or any devices intended for implantation in the human body. Should Buyer purchase or use ON Semiconductor products for any such unintended or unauthorized application, Buyer shall indemnify and hold ON Semiconductor and its officers, employees, subsidiaries, affiliates, and distributors harmless against all claims, costs, damages, and expenses, and reasonable attorney fees arising out of, directly or indirectly, any claim of personal injury or death associated with such unintended or unauthorized use, even if such claim alleges that ON Semiconductor was negligent regarding the design or manufacture of the part. ON Semiconductor is an Equal Opportunity/Affirmative Action Employer. This literature is subject to all applicable copyright laws and is not for resale in any manner.

MM74HCT273

Octal D-Type Flip-Flop with Clear

General Description

The MM74HCT273 utilizes advanced silicon-gate CMOS technology. It has an input threshold and output drive similar to LS-TTL with the low standby power of CMOS.

These positive edge-triggered flip-flops have a common clock and clear-independent Q outputs. Data on a D input, having the specified set-up and hold time, is transferred to the corresponding Q output on the positive-going transition of the clock pulse. The asynchronous clear forces all outputs LOW when it is LOW.

All inputs to this device are protected from damage due to electrostatic discharge by diodes to V_{CC} and ground.

MM74HCT devices are intended to interface TTL and NMOS components to CMOS components. These parts can be used as plug-in replacements to reduce system power consumption in existing designs.

Features

- Typical propagation delay: 20 ns
- Low quiescent current: 80 μ A maximum (74HCT series)
- Fanout of 10 LS-TTL loads

Ordering Code:

Order Number	Package Number	Package Description
MM74HCT273WM	M20B	20-Lead Small Outline Integrated Circuit (SOIC), JEDEC MS-013, 0.300" Wide
MM74HCT273SJ	M20D	20-Lead Small Outline Package (SOP), EIAJ TYPE II, 5.3mm Wide
MM74HCT273MTC	MTC20	20-Lead Thin Shrink Small Outline Package (TSSOP), JEDEC MO-153, 4.4mm Wide
MM74HCT273N	N20A	20-Lead Plastic Dual-In-Line Package (PDIP), JEDEC MS-001, 0.300" Wide

Devices also available in Tape and Reel. Specify by appending the suffix letter "X" to the ordering code.

Connection Diagram

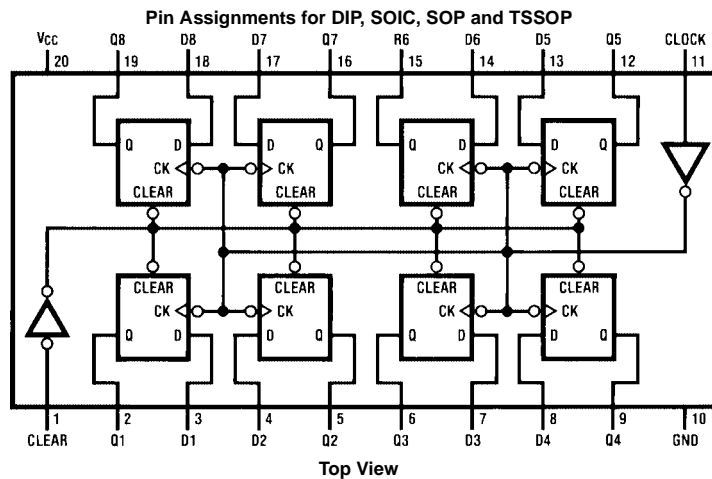

Truth Table

(Each Flip-Flop)

Inputs			Outputs
Clear	Clock	D	Q
L	X	X	L
H	↑	H	H
H	↑	L	L
H	L	X	Q0

H = HIGH Level (steady-state)
 L = LOW Level (steady-state)
 X = Don't Care
 ↑ = Transition from LOW-to-HIGH level
 Q0 = The level of Q before the indicated steady-state input conditions were established.

Logic Diagram

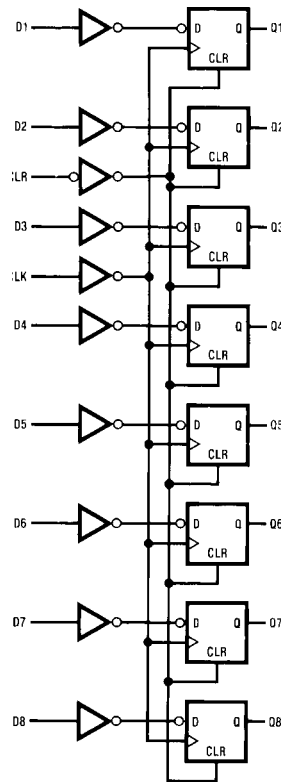

Absolute Maximum Ratings ^(Note 1)		Recommended Operating Conditions			
(Note 2)			Min	Max	Units
Supply Voltage (V_{CC})	-0.5V to + 7.0V	Supply Voltage (V_{CC})	4.5	5.5	V
DC Input Voltage (V_{IN})	-1.5V to $V_{CC} + 1.5V$	DC Input or Output Voltage			
DC Output Voltage (V_{OUT})	-0.5V to $V_{CC} + 0.5V$	(V_{IN}, V_{OUT})	0	V_{CC}	V
Clamp Diode Current (I_{IK}, I_{OK})	± 20 mA	Operating Temperature Range (T_A)	-40	+85	$^{\circ}C$
DC Output Current, per Pin (I_{OUT})	± 25 mA	Input Rise or Fall Times			
DC V_{CC} or GND Current, per Pin (I_{CC})	± 50 mA	(t_r, t_f)		500	ns
Storage Temperature Range (T_{STG})	-65 $^{\circ}C$ to + 150 $^{\circ}C$	Note 1: Absolute Maximum Ratings are those values beyond which damage to the device may occur.			
Power Dissipation (P_D)		Note 2: Unless otherwise specified all voltages are referenced to ground.			
(Note 3)	600 mW	Note 3: Power dissipation temperature derating—plastic "N" package: -12 mW/ $^{\circ}C$ from 65 $^{\circ}C$ to 85 $^{\circ}C$.			
S.O. Package only	500 mW				
Lead Temperature (T_L)					
(Soldering, 10 seconds)	260 $^{\circ}C$				

DC Electrical Characteristics

$V_{CC} = 5V \pm 10\%$ unless otherwise specified

Symbol	Parameter	Conditions	$T_A = 25^{\circ}C$		$T_A = -40^{\circ}C$ to $85^{\circ}C$	$T_A = -55^{\circ}C$ to $125^{\circ}C$	Units
			Typ	Guaranteed Limits			
V_{IH}	Minimum HIGH Level Input Voltage			2.0	2.0	2.0	V
V_{IL}	Maximum LOW Level Input Voltage			0.8	0.8	0.8	V
V_{OH}	Minimum HIGH Level Output Voltage	$V_{IN} = V_{IH}$ or V_{IL}	V_{CC}	$V_{CC}-0.1$	$V_{CC}-0.1$	$V_{CC}-0.1$	V
		$ I_{OUT} = 20 \mu A$	4.2	3.98	3.84	3.7	V
		$ I_{OUT} = 4.0$ mA, $V_{CC} = 4.5V$	5.2	4.98	4.84	4.7	V
V_{OL}	Minimum LOW Level Voltage	$V_{IN} = V_{IH}$ or V_{IL}	0	0.1	0.1	0.1	V
		$ I_{OUT} = 20 \mu A$	0.2	0.26	0.33	0.4	V
		$ I_{OUT} = 4.0$ mA, $V_{CC} = 4.5V$	0.2	0.26	0.33	0.4	V
I_{IN}	Maximum Input Current	$V_{IN} = V_{CC}$ or GND, V_{IH} or V_{IL}		± 0.1	± 1.0	± 1.0	μA
		$V_{IN} = V_{CC}$ or GND		8	80	160	μA
I_{CC}	Maximum Quiescent Supply Current	$I_{OUT} = 0 \mu A$		0.6	0.8	0.9	mA
		$V_{IN} = 2.4V$ or $0.5V$ (Note 4)					

Note 4: Measured per pin, all other inputs held at V_{CC} or GND.

AC Electrical Characteristics $V_{CC} = 5V$, $T_A = 25^\circ C$, $C_L = 15$ pF, $t_r = t_f = 6$ ns

Symbol	Parameter	Conditions	Typ	Guaranteed Limits	Units
f_{MAX}	Maximum Operating Frequency		68	30	MHz
t_{PHL} , t_{PLH}	Maximum Propagation Delay from Clock to Q		18	30	ns
t_{PHL} , t_{PLH}	Maximum Propagation Delay from Clear to Q		21	30	ns
t_{REM}	Minimum Removal Time, Clear to Clock		-1	5	ns
t_S	Minimum Set-Up Time D to Clock		6	20	ns
t_H	Minimum Hold Time Clock to D		-3	5	ns
t_W	Minimum Pulse Width Clock or Clear		10	16	ns

AC Electrical Characteristics $V_{CC} = 5.0V \pm 10\%$, $C_L = 50$ pF, $t_r = t_f = 6$ ns unless otherwise specified

Symbol	Parameter	Conditions	$T_A = 25^\circ C$		$T_A = -40^\circ C$ to $85^\circ C$	$T_A = -55^\circ C$ to $125^\circ C$	Units
			Typ	Guaranteed Limits			
f_{MAX}	Maximum Operating Frequency		68	27	21	18	MHz
t_{PHL} , t_{PLH}	Maximum Propagation Delay from Clock to Q		22	37	46	56	ns
t_{PHL} , t_{PLH}	Maximum Propagation Delay from Clear to Q		25	35	44	52	ns
t_{REM}	Minimum Removal Time Clear to Clock		-1	5	6	7	ns
t_S	Minimum Set-Up Time D to Clock		6	20	25	30	ns
t_H	Minimum Hold Time Clock to D		-3	5	5	5	ns
t_W	Minimum Pulse Width Clock or Clear		10	16	25	30	ns
t_r , t_f	Maximum Input Rise and Fall Time, Clock			500	500	500	ns
t_{THL} , t_{TLH}	Maximum Output Rise and Fall Time		11	15	19	22	ns
C_{PD}	Power Dissipation Capacitance (Note 5)	(Per Flip-Flop)	50				pF
C_{IN}	Maximum Input Capacitance		6	10	10	10	pF

Note 5: C_{PD} determines the no load dynamic power consumption, $P_D = C_{PD} V_{CC}^2 f + I_{CC} V_{CC}$, and the no load dynamic current consumption, $I_S = C_{PD} V_{CC}^2 f + I_{CC}$.

Physical Dimensions inches (millimeters) unless otherwise noted (Continued)



LAND PATTERN RECOMMENDATION



DIMENSIONS ARE IN MILLIMETERS



DETAIL A

NOTES:

- A. CONFORMS TO EIAJ EDR-7320 REGISTRATION, ESTABLISHED IN DECEMBER, 1998.
- B. DIMENSIONS ARE IN MILLIMETERS.
- C. DIMENSIONS ARE EXCLUSIVE OF BURRS, MOLD FLASH, AND TIE BAR EXTRUSIONS.

M20DRevB1

**20-Lead Small Outline Package (SOP), EIAJ TYPE II, 5.3mm Wide
Package Number M20D**

Physical Dimensions inches (millimeters) unless otherwise noted (Continued)

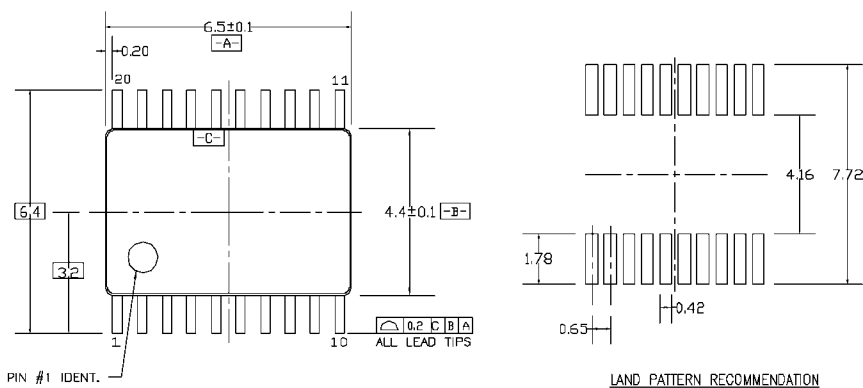

PIN #1 IDENT.

LAND PATTERN RECOMMENDATION

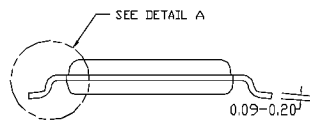
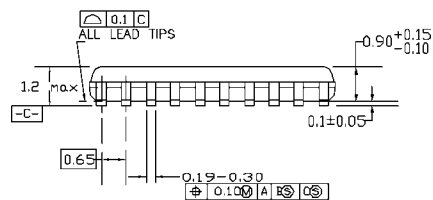

DIMENSIONS ARE IN MILLIMETERS

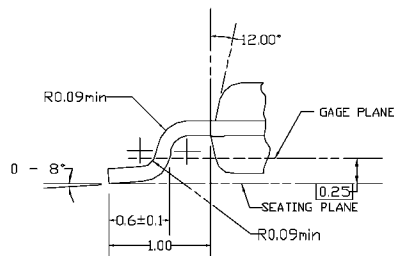

NOTES:

- A. CONFORMS TO JEDEC REGISTRATION MO-153, VARIATION AC, REF NOTE 6, DATE 7/93.
- B. DIMENSIONS ARE IN MILLIMETERS.
- C. DIMENSIONS ARE EXCLUSIVE OF BURRS, MOLDS FLASH, AND TIE BAR EXTRUSIONS.
- D. DIMENSIONS AND TOLERANCES PER ANSI Y14.5M, 1982.

MTC20REVD1

20-Lead Thin Shrink Small Outline Package (TSSOP), JEDEC MO-153, 4.4mm Wide Package Number MTC20

Physical Dimensions inches (millimeters) unless otherwise noted (Continued)

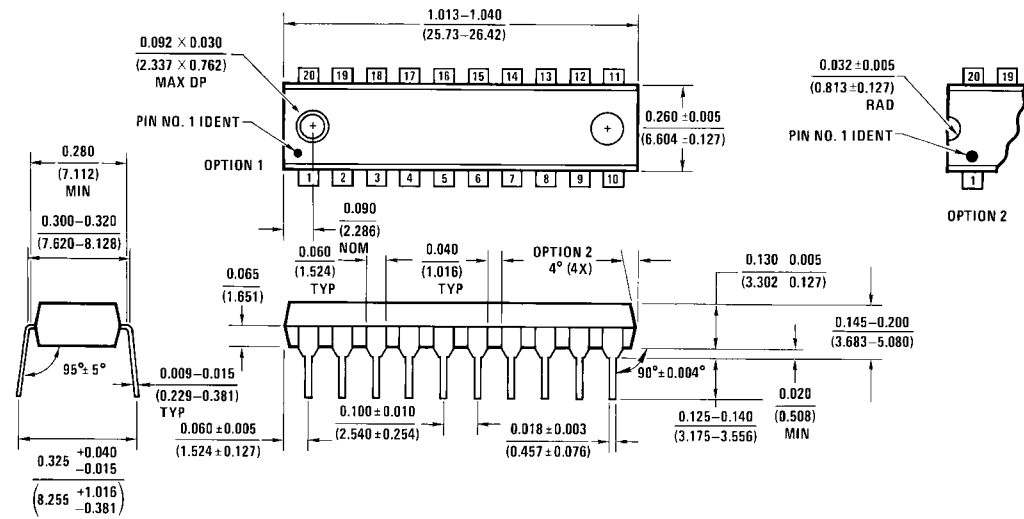

N20A (REV G)

20-Lead Plastic Dual-In-Line Package (PDIP), JEDEC MS-001, 0.300" Wide Package Number N20A

Fairchild does not assume any responsibility for use of any circuitry described, no circuit patent licenses are implied and Fairchild reserves the right at any time without notice to change said circuitry and specifications.

LIFE SUPPORT POLICY

FAIRCHILD'S PRODUCTS ARE NOT AUTHORIZED FOR USE AS CRITICAL COMPONENTS IN LIFE SUPPORT DEVICES OR SYSTEMS WITHOUT THE EXPRESS WRITTEN APPROVAL OF THE PRESIDENT OF FAIRCHILD SEMICONDUCTOR CORPORATION. As used herein:

1. Life support devices or systems are devices or systems which, (a) are intended for surgical implant into the body, or (b) support or sustain life, and (c) whose failure to perform when properly used in accordance with instructions for use provided in the labeling, can be reasonably expected to result in a significant injury to the user.
2. A critical component in any component of a life support device or system whose failure to perform can be reasonably expected to cause the failure of the life support device or system, or to affect its safety or effectiveness.

www.fairchildsemi.com

ON Semiconductor and  are trademarks of Semiconductor Components Industries, LLC dba ON Semiconductor or its subsidiaries in the United States and/or other countries. ON Semiconductor owns the rights to a number of patents, trademarks, copyrights, trade secrets, and other intellectual property. A listing of ON Semiconductor's product/patent coverage may be accessed at www.onsemi.com/site/pdf/Patent-Marking.pdf. ON Semiconductor reserves the right to make changes without further notice to any products herein. ON Semiconductor makes no warranty, representation or guarantee regarding the suitability of its products for any particular purpose, nor does ON Semiconductor assume any liability arising out of the application or use of any product or circuit, and specifically disclaims any and all liability, including without limitation special, consequential or incidental damages. Buyer is responsible for its products and applications using ON Semiconductor products, including compliance with all laws, regulations and safety requirements or standards, regardless of any support or applications information provided by ON Semiconductor. "Typical" parameters which may be provided in ON Semiconductor data sheets and/or specifications can and do vary in different applications and actual performance may vary over time. All operating parameters, including "Typicals" must be validated for each customer application by customer's technical experts. ON Semiconductor does not convey any license under its patent rights nor the rights of others. ON Semiconductor products are not designed, intended, or authorized for use as a critical component in life support systems or any FDA Class 3 medical devices or medical devices with a same or similar classification in a foreign jurisdiction or any devices intended for implantation in the human body. Should Buyer purchase or use ON Semiconductor products for any such unintended or unauthorized application, Buyer shall indemnify and hold ON Semiconductor and its officers, employees, subsidiaries, affiliates, and distributors harmless against all claims, costs, damages, and expenses, and reasonable attorney fees arising out of, directly or indirectly, any claim of personal injury or death associated with such unintended or unauthorized use, even if such claim alleges that ON Semiconductor was negligent regarding the design or manufacture of the part. ON Semiconductor is an Equal Opportunity/Affirmative Action Employer. This literature is subject to all applicable copyright laws and is not for resale in any manner.

PUBLICATION ORDERING INFORMATION

LITERATURE FULFILLMENT:

Literature Distribution Center for ON Semiconductor
19521 E. 32nd Pkwy, Aurora, Colorado 80011 USA
Phone: 303-675-2175 or 800-344-3860 Toll Free USA/Canada
Fax: 303-675-2176 or 800-344-3867 Toll Free USA/Canada
Email: orderlit@onsemi.com

N. American Technical Support: 800-282-9855 Toll Free
USA/Canada
Europe, Middle East and Africa Technical Support:
Phone: 421 33 790 2910
Japan Customer Focus Center
Phone: 81-3-5817-1050

ON Semiconductor Website: www.onsemi.com
Order Literature: <http://www.onsemi.com/orderlit>
For additional information, please contact your local
Sales Representative

Looking for pricing, stock, or lifecycle information?

Click below to explore more details on WIN SOURCE:

- ⊖ [View MM74HCT273MTCX on WIN SOURCE](#)
- ⊖ [Fairchild/ON Semiconductor Information](#)

Optimize Your Supply Chain with WIN SOURCE Solutions

- ✓ Global Sourcing Solution
- ✓ Obsolete Management
- ✓ Cost Control Management
- ✓ Shortage Management
- ✓ Alternative Solution
- ✓ Excess Inventory Management