



**THE DATASHEET OF
MLK1005S56NJT**



Inductors for high frequency circuits
Multilayer ceramic
MLK series (for automotive)



AEC-Q200

MLK1005 type



FEATURES

- With the adoption of a giga-spiral laminated structure, a self-resonant frequency higher than that of the MLG structure can be obtained, while the decrease of Q in the GHz band is limited.
- Monolithic structure is formed using a multilayering and sintering process with ceramic and conductive materials for high-frequency.
- There is no directivity.
- Operating temperature range: -55 to +125°C
- Compliant with AEC-Q200

APPLICATION

- Automotive equipment, smart phones, tablet terminals, high frequency modules (PAs, VCOs, FEMs , etc.), Bluetooth, W-LAN, UWB, tuners and other high frequency circuits for the mobile communication industry
- Application guides: [Car Infotainment](#)

PART NUMBER CONSTRUCTION

MLK	1005	S	1N0	S	T	D25
Series name	L×W×H dimensions 1.0×0.5×0.5 mm	Characteristics	Inductance (μH)	Inductance tolerance	Packaging style	Internal code

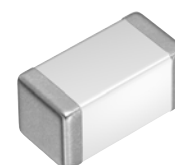

MLK1005 type

CHARACTERISTICS SPECIFICATION TABLE

L (nH)	Q Tolerance	Q min.	Q measuring frequency (MHz)	Self-resonant frequency		DC resistance		Rated current (mA)max.	Part No.
				(GHz)min.	(GHz)typ.	(Ω)max.	(Ω)typ.		
1.0	$\pm 0.3\text{nH}$	5	100	12.0	16.9	0.10	0.05	500	MLK1005S1N0STD25
1.1	$\pm 0.3\text{nH}$	5	100	11.5	14.8	0.12	0.05	500	MLK1005S1N1STD25
1.2	$\pm 0.3\text{nH}$	5	100	11.0	14.4	0.12	0.05	500	MLK1005S1N2STD25
1.3	$\pm 0.3\text{nH}$	5	100	10.0	12.6	0.15	0.06	500	MLK1005S1N3STD25
1.5	$\pm 0.3\text{nH}$	6	100	9.5	12.2	0.15	0.06	500	MLK1005S1N5STD25
1.6	$\pm 0.3\text{nH}$	6	100	9.0	11.9	0.17	0.06	500	MLK1005S1N6STD25
1.8	$\pm 0.3\text{nH}$	6	100	8.5	10.9	0.17	0.07	500	MLK1005S1N8STD25
2.0	$\pm 0.3\text{nH}$	6	100	8.3	10.0	0.18	0.08	500	MLK1005S2N0STD25
2.2	$\pm 0.3\text{nH}$	6	100	8.0	9.6	0.18	0.08	500	MLK1005S2N2STD25
2.4	$\pm 0.3\text{nH}$	6	100	7.8	9.5	0.20	0.09	500	MLK1005S2N4STD25
2.7	$\pm 0.3\text{nH}$	6	100	7.5	9.1	0.20	0.10	500	MLK1005S2N7STD25
3.0	$\pm 0.3\text{nH}$	6	100	7.2	8.5	0.22	0.10	400	MLK1005S3N0STD25
3.3	$\pm 0.3\text{nH}$	7	100	7.0	8.3	0.22	0.11	400	MLK1005S3N3STD25
3.6	$\pm 0.3\text{nH}$	7	100	6.8	8.1	0.25	0.11	400	MLK1005S3N6STD25
3.9	$\pm 0.3\text{nH}$	7	100	6.5	7.8	0.25	0.12	400	MLK1005S3N9STD25
4.3	$\pm 0.3\text{nH}$	7	100	6.3	7.4	0.28	0.13	400	MLK1005S4N3STD25
4.7	$\pm 0.3\text{nH}$	7	100	6.0	6.9	0.28	0.13	400	MLK1005S4N7STD25
5.1	$\pm 0.3\text{nH}$	7	100	5.8	7.0	0.30	0.15	400	MLK1005S5N1STD25
5.6	$\pm 0.3\text{nH}$	7	100	5.7	6.7	0.30	0.15	400	MLK1005S5N6STD25
6.2	$\pm 0.3\text{nH}$	7	100	5.6	6.5	0.35	0.18	400	MLK1005S6N2STD25
6.8	$\pm 5\%$	7	100	5.5	6.3	0.35	0.18	400	MLK1005S6N8JTD25
7.5	$\pm 5\%$	7	100	5.0	6.0	0.38	0.20	350	MLK1005S7N5JTD25
8.2	$\pm 5\%$	7	100	5.0	6.0	0.38	0.21	350	MLK1005S8N2JTD25
9.1	$\pm 5\%$	7	100	4.8	5.9	0.42	0.23	350	MLK1005S9N1JTD25
10	$\pm 5\%$	7	100	4.7	5.2	0.42	0.23	350	MLK1005S10NJTD25
12	$\pm 5\%$	7	100	4.3	5.3	0.47	0.27	350	MLK1005S12NJTD25
15	$\pm 5\%$	7	100	4.0	4.8	0.50	0.33	300	MLK1005S15NJTD25
18	$\pm 5\%$	7	100	4.0	4.7	0.60	0.38	250	MLK1005S18NJTD25
22	$\pm 5\%$	7	100	3.5	4.4	0.70	0.46	200	MLK1005S22NJTD25
27	$\pm 5\%$	7	100	3.0	3.9	0.80	0.53	200	MLK1005S27NJTD25
33	$\pm 5\%$	7	100	2.5	3.5	0.90	0.59	200	MLK1005S33NJTD25
39	$\pm 5\%$	6	100	2.0	3.1	1.00	0.65	200	MLK1005S39NJTD25
47	$\pm 5\%$	6	100	1.8	3.0	1.20	0.74	200	MLK1005S47NJTD25
56	$\pm 5\%$	6	100	1.5	2.6	1.30	0.84	200	MLK1005S56NJTD25
68	$\pm 5\%$	6	100	1.4	2.4	1.50	1.01	150	MLK1005S68NJTD25
82	$\pm 5\%$	6	100	1.3	2.2	1.80	1.39	150	MLK1005S82NJTD25
100	$\pm 5\%$	6	100	1.1	1.9	2.20	1.60	100	MLK1005SR10JTD25
110	$\pm 5\%$	6	100	1.1	2.0	2.70	1.89	100	MLK1005SR11JTD25
120	$\pm 5\%$	6	100	1.1	1.9	3.00	2.08	100	MLK1005SR12JTD25
130	$\pm 5\%$	6	100	1.1	1.8	3.30	2.28	100	MLK1005SR13JTD25
150	$\pm 5\%$	6	100	1.1	1.7	5.00	3.58	80	MLK1005SR15JTD25
160	$\pm 5\%$	6	100	1.1	1.7	5.20	3.79	80	MLK1005SR16JTD25
180	$\pm 5\%$	6	100	1.1	1.6	6.00	4.28	80	MLK1005SR18JTD25
200	$\pm 5\%$	6	100	1.1	1.5	6.20	4.56	70	MLK1005SR20JTD25
220	$\pm 5\%$	6	100	1.0	1.4	6.20	4.54	70	MLK1005SR22JTD25
240	$\pm 5\%$	6	100	1.0	1.3	6.50	4.84	70	MLK1005SR24JTD25
270	$\pm 5\%$	6	100	0.9	1.2	6.50	4.78	70	MLK1005SR27JTD25
300	$\pm 5\%$	6	100	0.9	1.2	7.50	5.37	70	MLK1005SR30JTD25
330	$\pm 5\%$	6	100	0.85	1.1	8.00	5.82	70	MLK1005SR33JTD25

Measurement equipment

Measurement item	Product No.	Manufacturer
L, Q	4291B+16193A	Keysight Technologies
Self-resonant frequency	8720C	Keysight Technologies
DC resistance	Type-7561	Yokogawa

* Equivalent measurement equipment may be used.

MLK1005 type

L, Q FREQUENCY CHARACTERISTICS TABLE

L(nH)typ.					Q typ.					Part No.
500MHz	800MHz	1.8GHz	2.0GHz	2.4GHz	500MHz	800MHz	1.8GHz	2.0GHz	2.4GHz	
0.9	0.9	0.9	0.9	0.9	16	20	30	32	36	MLK1005S1N0STD25
1.0	1.0	1.0	1.0	1.0	16	20	32	35	39	MLK1005S1N1STD25
1.1	1.1	1.1	1.1	1.1	15	18	28	30	33	MLK1005S1N2STD25
1.2	1.2	1.2	1.2	1.2	17	20	33	35	39	MLK1005S1N3STD25
1.4	1.4	1.4	1.4	1.4	15	19	29	31	34	MLK1005S1N5STD25
1.5	1.5	1.5	1.5	1.5	17	21	34	36	40	MLK1005S1N6STD25
1.7	1.7	1.7	1.7	1.7	16	21	32	33	37	MLK1005S1N8STD25
1.9	1.8	1.9	1.9	1.9	16	20	32	34	38	MLK1005S2N0STD25
2.0	2.0	2.0	2.0	2.1	15	19	29	31	34	MLK1005S2N2STD25
2.2	2.2	2.2	2.3	2.3	16	20	32	34	38	MLK1005S2N4STD25
2.5	2.5	2.5	2.6	2.6	17	22	33	35	39	MLK1005S2N7STD25
2.8	2.8	2.8	2.9	2.9	18	22	35	36	41	MLK1005S3N0STD25
3.1	3.1	3.1	3.1	3.2	16	20	31	32	36	MLK1005S3N3STD25
3.4	3.3	3.4	3.5	3.5	17	22	33	35	39	MLK1005S3N6STD25
3.7	3.6	3.7	3.7	3.8	17	21	32	33	37	MLK1005S3N9STD25
4.0	4.0	4.1	4.2	4.3	17	22	34	35	39	MLK1005S4N3STD25
4.4	4.4	4.5	4.6	4.7	17	22	33	35	38	MLK1005S4N7STD25
4.8	4.8	4.9	5.0	5.1	17	22	33	35	38	MLK1005S5N1STD25
5.3	5.2	5.4	5.5	5.7	17	22	33	34	38	MLK1005S5N6STD25
5.8	5.8	6.0	6.2	6.4	18	23	34	35	39	MLK1005S6N2STD25
6.4	6.4	6.6	6.7	7.0	17	22	32	33	36	MLK1005S6N8JTD25
7.1	7.0	7.4	7.6	7.9	18	23	34	36	38	MLK1005S7N5JTD25
7.7	7.7	8.1	8.3	8.6	19	23	34	36	38	MLK1005S8N2JTD25
8.6	8.6	9.1	9.3	9.7	18	23	34	36	38	MLK1005S9N1JTD25
9.4	9.4	10.0	10.2	10.7	19	23	34	35	38	MLK1005S10NJTD25
11.3	11.3	12.1	12.4	13.0	19	23	34	35	37	MLK1005S12NJTD25
14.2	14.2	15.3	15.8	16.8	18	23	33	34	35	MLK1005S15NJTD25
17.0	17.1	18.6	19.2	20.6	18	23	32	33	34	MLK1005S18NJTD25
20.8	20.9	23.0	23.9	25.8	18	23	32	33	34	MLK1005S22NJTD25
25.6	25.9	29.8	31.5	35.7	18	23	30	30	28	MLK1005S27NJTD25
31.4	31.9	37.6	40.2		18	23	29	29		MLK1005S33NJTD25
37.2	38.1	48.9			17	21	24			MLK1005S39NJTD25
45.0	46.2	60.6			18	21	24			MLK1005S47NJTD25
53.7	55.4	76.7			17	21	22			MLK1005S56NJTD25
65.5	68.4	105.6			17	20	18			MLK1005S68NJTD25
79.3	83.6	142.7			16	19	15			MLK1005S82NJTD25
97.1	103.2	199.4			15	18	13			MLK1005SR10JTD25
107.8	115.9				16	18				MLK1005SR11JTD25
118.0	127.8				16	18				MLK1005SR12JTD25
127.5	139.5				14	16				MLK1005SR13JTD25
149.4	166.0				16	17				MLK1005SR15JTD25
160.5	179.4				16	18				MLK1005SR16JTD25
181.1	204.1				16	17				MLK1005SR18JTD25
202.8	231.9				15	17				MLK1005SR20JTD25
225.7	266.8				15	15				MLK1005SR22JTD25
248.3	299.6				14	15				MLK1005SR24JTD25
290.0	386.0				14	12				MLK1005SR27JTD25
323.1	432.6				14	12				MLK1005SR30JTD25
358.9	493.1				13	12				MLK1005SR33JTD25

Measurement equipment

Product No.	Manufacturer
4291B+16193A	Keysight Technologies

* Equivalent measurement equipment may be used.

MLK1005 type

L FREQUENCY CHARACTERISTICS (EXAMPLE)



Measurement equipment

Product No.	Manufacturer
E4991A+16193A	Keysight Technologies

* Equivalent measurement equipment may be used.

MLK1005 type

Q FREQUENCY CHARACTERISTICS (EXAMPLE)



Measurement equipment

Product No.	Manufacturer
E4991A+16193A	Keysight Technologies

* Equivalent measurement equipment may be used.

MLK1005 type

SHAPE & DIMENSIONS

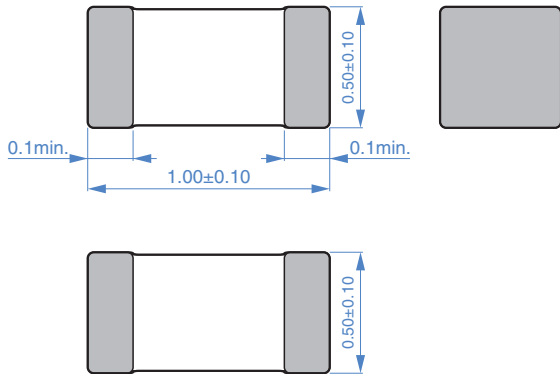

Dimensions in mm

PACKAGING STYLE

REEL DIMENSIONS

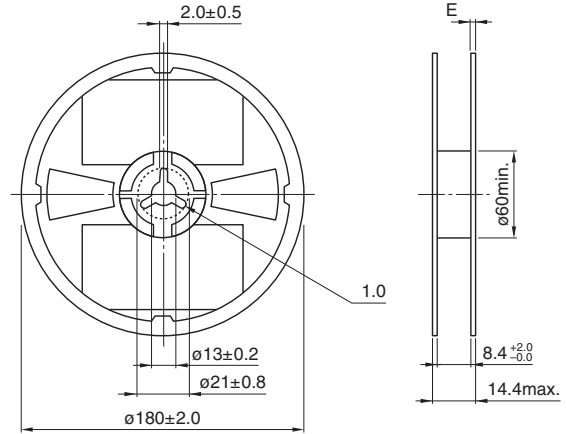

Dimensions in mm

RECOMMENDED LAND PATTERN

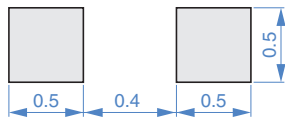

Dimensions in mm

TAPE DIMENSIONS

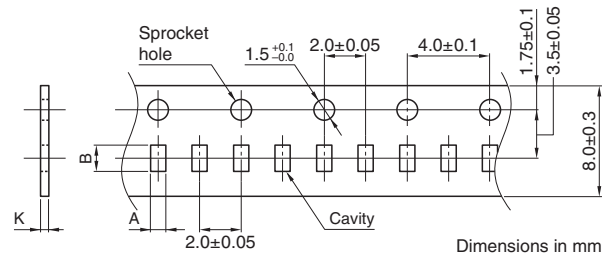

Dimensions in mm

RECOMMENDED REFLOW PROFILE

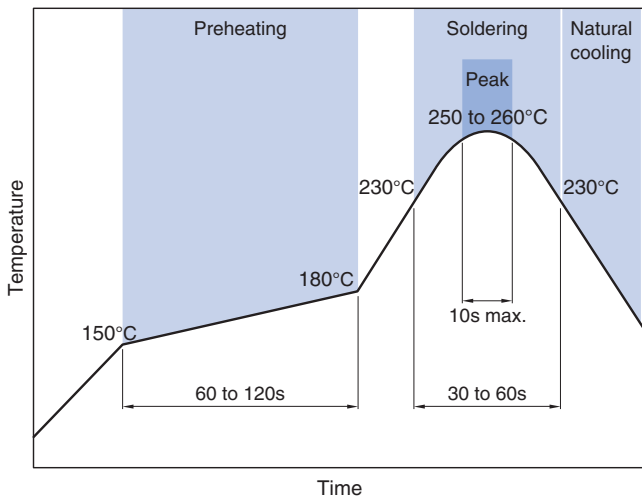

Type	A	B	K
MLK1005	0.67±0.1	1.15±0.1	0.8 max.

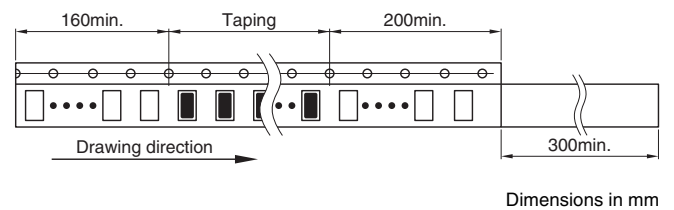

Dimensions in mm

PACKAGE QUANTITY

Package quantity	10000pcs/reel
------------------	---------------

TEMPERATURE RANGE, INDIVIDUAL WEIGHT

Operating temperature range	Storage temperature range*	Individual weight
-55 to +125 °C	-55 to +125 °C	1 mg

* The storage temperature range is for after the assembly.

REMINDERS FOR USING THESE PRODUCTS

Before using these products, be sure to request the delivery specifications.

SAFETY REMINDERS

Please pay sufficient attention to the warnings for safe designing when using this products.

REMINDERS

- The storage period is less than 12 months. Be sure to follow the storage conditions (temperature: 5 to 40°C, humidity: 10 to 75% RH or less).
If the storage period elapses, the soldering of the terminal electrodes may deteriorate.
- Do not use or store in locations where there are conditions such as gas corrosion (salt, acid, alkali, etc.).
- Before soldering, be sure to preheat components.
The preheating temperature should be set so that the temperature difference between the solder temperature and chip temperature does not exceed 150°C.
- Soldering corrections after mounting should be within the range of the conditions determined in the specifications.
If overheated, a short circuit, performance deterioration, or lifespan shortening may occur.
- When embedding a printed circuit board where a chip is mounted to a set, be sure that residual stress is not given to the chip due to the overall distortion of the printed circuit board and partial distortion such as at screw tightening portions.
- Self heating (temperature increase) occurs when the power is turned ON, so the tolerance should be sufficient for the set thermal design.
- Carefully lay out the coil for the circuit board design of the non-magnetic shield type.
A malfunction may occur due to magnetic interference.
- Use a wrist band to discharge static electricity in your body through the grounding wire.
- Do not expose the products to magnets or magnetic fields.
- Do not use for a purpose outside of the contents regulated in the delivery specifications.
- The products listed on this catalog are intended for use in general electronic equipment (AV equipment, telecommunications equipment, home appliances, amusement equipment, computer equipment, personal equipment, office equipment, measurement equipment, industrial robots) under a normal operation and use condition.
The products are not designed or warranted to meet the requirements of the applications listed below, whose performance and/or quality require a more stringent level of safety or reliability, or whose failure, malfunction or trouble could cause serious damage to society, person or property.
If you intend to use the products in the applications listed below or if you have special requirements exceeding the range or conditions set forth in the each catalog, please contact us.

- (1) Aerospace/aviation equipment
- (2) Transportation equipment (electric trains, ships, etc.)
- (3) Medical equipment
- (4) Power-generation control equipment
- (5) Atomic energy-related equipment
- (6) Seabed equipment
- (7) Transportation control equipment

- (8) Public information-processing equipment
- (9) Military equipment
- (10) Electric heating apparatus, burning equipment
- (11) Disaster prevention/crime prevention equipment
- (12) Safety equipment
- (13) Other applications that are not considered general-purpose applications

When designing your equipment even for general-purpose applications, you are kindly requested to take into consideration securing protection circuit/device or providing backup circuits in your equipment.

Looking for pricing, stock, or lifecycle information?

Click below to explore more details on WIN SOURCE:

 [View MLK1005S56NJT](#) on WIN SOURCE

 [TDK Corporation](#) Information

Optimize Your Supply Chain with WIN SOURCE Solutions

-  Global Sourcing Solution
-  Obsolete Management
-  Cost Control Management
-  Shortage Management
-  Alternative Solution
-  Excess Inventory Management