



**THE DATASHEET OF
MLG1005S0N5BTD25**



Inductors for high frequency circuits
Multilayer ceramic
MLG series (for automotive)



AEC-Q200

MLG1005S type



FEATURES

- Advanced monolithic structure is formed using a multilayering and sintering process with ceramic and conductive materials for high-frequency.
- Operating temperature range: -55 to +125°C
- Compliant with AEC-Q200

APPLICATION

- Automotive equipment, smart phones, tablet terminals, high frequency modules (PAs, VCOs, FEMs , etc.), Bluetooth, W-LAN, UWB, tuners and other high frequency circuits for the mobile communication industry
- Application guides: [Car Infotainment](#)

PART NUMBER CONSTRUCTION

| | | | | | | |
|-------------|------------------------------------|-----------------------|-----------------|----------------------|-----------------|---------------|
| MLG | 1005 | S | 0N3 | B | T | D25 |
| Series name | L×W×H dimensions 1.0×0.5×0.5 mm | Product internal code | Inductance (nH) | Inductance tolerance | Packaging style | Internal code |

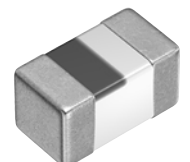

MLG1005S type

CHARACTERISTICS SPECIFICATION TABLE

| L (nH) | Q Tolerance | L, Q measuring frequency min. (MHz) | Self-resonant frequency | | DC resistance | | Rated current (mA)max. | Part No.* | |
|-----------|----------------|--|----------------------------|-----------|------------------|------------------|---------------------------|-----------|----------------------------------|
| | | | (GHz)min. | (GHz)typ. | (Ω)max. | (Ω)typ. | | | |
| 0.3 | ± 0.1 nH | — | 100 | 10.0 | 20up | 0.10 | 0.01 | 1000 | MLG1005S0N3BTD25 |
| 0.3 | ± 0.2 nH | — | 100 | 10.0 | 20up | 0.10 | 0.01 | 1000 | MLG1005S0N3CTD25 |
| 0.4 | ± 0.1 nH | — | 100 | 10.0 | 20up | 0.10 | 0.01 | 1000 | MLG1005S0N4BTD25 |
| 0.4 | ± 0.2 nH | — | 100 | 10.0 | 20up | 0.10 | 0.01 | 1000 | MLG1005S0N4CTD25 |
| 0.5 | ± 0.1 nH | — | 100 | 10.0 | 20up | 0.10 | 0.01 | 1000 | MLG1005S0N5BTD25 |
| 0.5 | ± 0.2 nH | — | 100 | 10.0 | 20up | 0.10 | 0.01 | 1000 | MLG1005S0N5CTD25 |
| 0.6 | ± 0.1 nH | — | 100 | 10.0 | 20up | 0.10 | 0.01 | 1000 | MLG1005S0N6BTD25 |
| 0.6 | ± 0.2 nH | — | 100 | 10.0 | 20up | 0.10 | 0.01 | 1000 | MLG1005S0N6CTD25 |
| 0.7 | ± 0.1 nH | — | 100 | 10.0 | 18.7 | 0.10 | 0.02 | 1000 | MLG1005S0N7BTD25 |
| 0.7 | ± 0.2 nH | — | 100 | 10.0 | 18.7 | 0.10 | 0.02 | 1000 | MLG1005S0N7CTD25 |
| 0.8 | ± 0.1 nH | — | 100 | 10.0 | 16.4 | 0.10 | 0.02 | 1000 | MLG1005S0N8BTD25 |
| 0.8 | ± 0.2 nH | — | 100 | 10.0 | 16.4 | 0.10 | 0.02 | 1000 | MLG1005S0N8CTD25 |
| 0.9 | ± 0.1 nH | — | 100 | 10.0 | 17.7 | 0.10 | 0.04 | 1000 | MLG1005S0N9BTD25 |
| 0.9 | ± 0.2 nH | — | 100 | 10.0 | 17.7 | 0.10 | 0.04 | 1000 | MLG1005S0N9CTD25 |
| 1.0 | ± 0.1 nH | 7 | 100 | 10.0 | 13.8 | 0.10 | 0.04 | 1000 | MLG1005S1N0BTD25 |
| 1.0 | ± 0.2 nH | 7 | 100 | 10.0 | 13.8 | 0.10 | 0.04 | 1000 | MLG1005S1N0CTD25 |
| 1.0 | ± 0.3 nH | 7 | 100 | 10.0 | 13.8 | 0.10 | 0.04 | 1000 | MLG1005S1N0STD25 |
| 1.1 | ± 0.1 nH | 7 | 100 | 10.0 | 19.3 | 0.10 | 0.03 | 1000 | MLG1005S1N1BTD25 |
| 1.1 | ± 0.2 nH | 7 | 100 | 10.0 | 19.3 | 0.10 | 0.03 | 1000 | MLG1005S1N1CTD25 |
| 1.1 | ± 0.3 nH | 7 | 100 | 10.0 | 19.3 | 0.10 | 0.03 | 1000 | MLG1005S1N1STD25 |
| 1.2 | ± 0.1 nH | 7 | 100 | 10.0 | 11.6 | 0.10 | 0.04 | 1000 | MLG1005S1N2BTD25 |
| 1.2 | ± 0.2 nH | 7 | 100 | 10.0 | 11.6 | 0.10 | 0.04 | 1000 | MLG1005S1N2CTD25 |
| 1.2 | ± 0.3 nH | 7 | 100 | 10.0 | 11.6 | 0.10 | 0.04 | 1000 | MLG1005S1N2STD25 |
| 1.3 | ± 0.1 nH | 7 | 100 | 8.00 | 11.7 | 0.10 | 0.04 | 1000 | MLG1005S1N3BTD25 |
| 1.3 | ± 0.2 nH | 7 | 100 | 8.00 | 11.7 | 0.10 | 0.04 | 1000 | MLG1005S1N3CTD25 |
| 1.3 | ± 0.3 nH | 7 | 100 | 8.00 | 11.7 | 0.10 | 0.04 | 1000 | MLG1005S1N3STD25 |
| 1.5 | ± 0.1 nH | 7 | 100 | 8.00 | 9.6 | 0.10 | 0.06 | 1000 | MLG1005S1N5BTD25 |
| 1.5 | ± 0.2 nH | 7 | 100 | 8.00 | 9.6 | 0.10 | 0.06 | 1000 | MLG1005S1N5CTD25 |
| 1.5 | ± 0.3 nH | 7 | 100 | 8.00 | 9.6 | 0.10 | 0.06 | 1000 | MLG1005S1N5STD25 |
| 1.6 | ± 0.1 nH | 7 | 100 | 7.50 | 9.4 | 0.12 | 0.05 | 1000 | MLG1005S1N6BTD25 |
| 1.6 | ± 0.2 nH | 7 | 100 | 7.50 | 9.4 | 0.12 | 0.05 | 1000 | MLG1005S1N6CTD25 |
| 1.6 | ± 0.3 nH | 7 | 100 | 7.50 | 9.4 | 0.12 | 0.05 | 1000 | MLG1005S1N6STD25 |
| 1.8 | ± 0.1 nH | 7 | 100 | 8.00 | 10.3 | 0.15 | 0.06 | 900 | MLG1005S1N8BTD25 |
| 1.8 | ± 0.2 nH | 7 | 100 | 8.00 | 10.3 | 0.15 | 0.06 | 900 | MLG1005S1N8CTD25 |
| 1.8 | ± 0.3 nH | 7 | 100 | 8.00 | 10.3 | 0.15 | 0.06 | 900 | MLG1005S1N8STD25 |
| 2.0 | ± 0.1 nH | 7 | 100 | 7.50 | 9.3 | 0.15 | 0.07 | 900 | MLG1005S2N0BTD25 |
| 2.0 | ± 0.2 nH | 7 | 100 | 7.50 | 9.3 | 0.15 | 0.07 | 900 | MLG1005S2N0CTD25 |
| 2.0 | ± 0.3 nH | 7 | 100 | 7.50 | 9.3 | 0.15 | 0.07 | 900 | MLG1005S2N0STD25 |
| 2.2 | ± 0.1 nH | 7 | 100 | 7.00 | 8.6 | 0.15 | 0.08 | 900 | MLG1005S2N2BTD25 |
| 2.2 | ± 0.2 nH | 7 | 100 | 7.00 | 8.6 | 0.15 | 0.08 | 900 | MLG1005S2N2CTD25 |
| 2.2 | ± 0.3 nH | 7 | 100 | 7.00 | 8.6 | 0.15 | 0.08 | 900 | MLG1005S2N2STD25 |
| 2.4 | ± 0.1 nH | 7 | 100 | 7.00 | 8.2 | 0.15 | 0.08 | 800 | MLG1005S2N4BTD25 |
| 2.4 | ± 0.2 nH | 7 | 100 | 7.00 | 8.2 | 0.15 | 0.08 | 800 | MLG1005S2N4CTD25 |
| 2.4 | ± 0.3 nH | 7 | 100 | 7.00 | 8.2 | 0.15 | 0.08 | 800 | MLG1005S2N4STD25 |

* Please contact us for information on inductance tolerance, G ($\pm 2\%$).

Measurement equipment

| Measurement item | Product No. | Manufacturer |
|-------------------------|---------------|-----------------------|
| L, Q | 4291B +16193A | Keysight Technologies |
| Self-resonant frequency | 8720C | Keysight Technologies |
| DC resistance | Type-7561 | Yokogawa |

* Equivalent measurement equipment may be used.

MLG1005S type

CHARACTERISTICS SPECIFICATION TABLE

| L (nH) | Q Tolerance | Q min. | L, Q measuring frequency (MHz) | Self-resonant frequency | | DC resistance | | Rated current (mA)max. | Part No.* |
|-----------|----------------|-----------|--------------------------------------|----------------------------|-----------|------------------|------------------|---------------------------|-----------------------------------|
| | | | | (GHz)min. | (GHz)typ. | (Ω)max. | (Ω)typ. | | |
| 2.7 | ± 0.1 nH | 7 | 100 | 6.00 | 7.3 | 0.15 | 0.08 | 800 | MLG1005S2N7BTD25 |
| 2.7 | ± 0.2 nH | 7 | 100 | 6.00 | 7.3 | 0.15 | 0.08 | 800 | MLG1005S2N7CTD25 |
| 2.7 | ± 0.3 nH | 7 | 100 | 6.00 | 7.3 | 0.15 | 0.08 | 800 | MLG1005S2N7STD25 |
| 3.0 | ± 0.1 nH | 7 | 100 | 5.50 | 6.8 | 0.20 | 0.09 | 800 | MLG1005S3N0BTD25 |
| 3.0 | ± 0.2 nH | 7 | 100 | 5.50 | 6.8 | 0.20 | 0.09 | 800 | MLG1005S3N0STD25 |
| 3.0 | ± 0.3 nH | 7 | 100 | 5.50 | 6.8 | 0.20 | 0.09 | 800 | MLG1005S3N0STD25 |
| 3.3 | ± 0.1 nH | 8 | 100 | 5.00 | 6.1 | 0.20 | 0.09 | 800 | MLG1005S3N3BTD25 |
| 3.3 | ± 0.2 nH | 8 | 100 | 5.00 | 6.1 | 0.20 | 0.09 | 800 | MLG1005S3N3CTD25 |
| 3.3 | ± 0.3 nH | 8 | 100 | 5.00 | 6.1 | 0.20 | 0.09 | 800 | MLG1005S3N3STD25 |
| 3.6 | ± 0.1 nH | 8 | 100 | 5.00 | 6.7 | 0.20 | 0.09 | 700 | MLG1005S3N6BTD25 |
| 3.6 | ± 0.2 nH | 8 | 100 | 5.00 | 6.7 | 0.20 | 0.09 | 700 | MLG1005S3N6CTD25 |
| 3.6 | ± 0.3 nH | 8 | 100 | 5.00 | 6.7 | 0.20 | 0.09 | 700 | MLG1005S3N6STD25 |
| 3.9 | ± 0.1 nH | 8 | 100 | 5.00 | 6.5 | 0.20 | 0.11 | 700 | MLG1005S3N9BTD25 |
| 3.9 | ± 0.2 nH | 8 | 100 | 5.00 | 6.5 | 0.20 | 0.11 | 700 | MLG1005S3N9CTD25 |
| 3.9 | ± 0.3 nH | 8 | 100 | 5.00 | 6.5 | 0.20 | 0.11 | 700 | MLG1005S3N9STD25 |
| 4.3 | ± 0.2 nH | 8 | 100 | 4.50 | 6.0 | 0.20 | 0.11 | 700 | MLG1005S4N3CTD25 |
| 4.3 | ± 0.3 nH | 8 | 100 | 4.50 | 6.0 | 0.20 | 0.11 | 700 | MLG1005S4N3STD25 |
| 4.7 | ± 0.2 nH | 8 | 100 | 4.50 | 5.4 | 0.25 | 0.12 | 700 | MLG1005S4N7CTD25 |
| 4.7 | ± 0.3 nH | 8 | 100 | 4.50 | 5.4 | 0.25 | 0.12 | 700 | MLG1005S4N7STD25 |
| 5.1 | ± 0.2 nH | 8 | 100 | 4.00 | 5.0 | 0.25 | 0.13 | 600 | MLG1005S5N1CTD25 |
| 5.1 | ± 0.3 nH | 8 | 100 | 4.00 | 5.0 | 0.25 | 0.13 | 600 | MLG1005S5N1STD25 |
| 5.6 | ± 0.2 nH | 8 | 100 | 4.00 | 5.3 | 0.25 | 0.14 | 600 | MLG1005S5N6CTD25 |
| 5.6 | ± 0.3 nH | 8 | 100 | 4.00 | 5.3 | 0.25 | 0.14 | 600 | MLG1005S5N6STD25 |
| 6.2 | $\pm 3\%$ | 8 | 100 | 4.00 | 4.7 | 0.25 | 0.16 | 600 | MLG1005S6N2HTD25 |
| 6.2 | ± 0.3 nH | 8 | 100 | 4.00 | 4.7 | 0.25 | 0.16 | 600 | MLG1005S6N2STD25 |
| 6.8 | $\pm 3\%$ | 8 | 100 | 3.50 | 4.4 | 0.25 | 0.15 | 600 | MLG1005S6N8HTD25 |
| 6.8 | $\pm 5\%$ | 8 | 100 | 3.50 | 4.4 | 0.25 | 0.15 | 600 | MLG1005S6N8JTD25 |
| 7.5 | $\pm 3\%$ | 8 | 100 | 3.00 | 4.1 | 0.25 | 0.15 | 500 | MLG1005S7N5HTD25 |
| 7.5 | $\pm 5\%$ | 8 | 100 | 3.00 | 4.1 | 0.25 | 0.15 | 500 | MLG1005S7N5JTD25 |
| 8.2 | $\pm 3\%$ | 8 | 100 | 3.00 | 4.0 | 0.30 | 0.19 | 500 | MLG1005S8N2HTD25 |
| 8.2 | $\pm 5\%$ | 8 | 100 | 3.00 | 4.0 | 0.30 | 0.19 | 500 | MLG1005S8N2JTD25 |
| 9.1 | $\pm 3\%$ | 8 | 100 | 3.00 | 3.8 | 0.30 | 0.20 | 500 | MLG1005S9N1HTD25 |
| 9.1 | $\pm 5\%$ | 8 | 100 | 3.00 | 3.8 | 0.30 | 0.20 | 500 | MLG1005S9N1JTD25 |
| 10 | $\pm 3\%$ | 8 | 100 | 2.50 | 3.4 | 0.35 | 0.22 | 500 | MLG1005S10NHHTD25 |
| 10 | $\pm 5\%$ | 8 | 100 | 2.50 | 3.4 | 0.35 | 0.22 | 500 | MLG1005S10NJTD25 |
| 11 | $\pm 3\%$ | 8 | 100 | 2.50 | 3.5 | 0.40 | 0.28 | 400 | MLG1005S11NHHTD25 |
| 11 | $\pm 5\%$ | 8 | 100 | 2.50 | 3.5 | 0.40 | 0.28 | 400 | MLG1005S11NJTD25 |
| 12 | $\pm 3\%$ | 8 | 100 | 2.50 | 3.0 | 0.40 | 0.25 | 400 | MLG1005S12NHHTD25 |
| 12 | $\pm 5\%$ | 8 | 100 | 2.50 | 3.0 | 0.40 | 0.25 | 400 | MLG1005S12NJTD25 |
| 13 | $\pm 3\%$ | 8 | 100 | 2.40 | 2.9 | 0.50 | 0.26 | 400 | MLG1005S13NHHTD25 |
| 13 | $\pm 5\%$ | 8 | 100 | 2.40 | 2.9 | 0.50 | 0.26 | 400 | MLG1005S13NJTD25 |
| 15 | $\pm 3\%$ | 8 | 100 | 2.20 | 2.8 | 0.55 | 0.35 | 400 | MLG1005S15NHHTD25 |
| 15 | $\pm 5\%$ | 8 | 100 | 2.20 | 2.8 | 0.55 | 0.35 | 400 | MLG1005S15NJTD25 |

* Please contact us for information on inductance tolerance, G ($\pm 2\%$).

Measurement equipment

| Measurement item | Product No. | Manufacturer |
|-------------------------|---------------|-----------------------|
| L, Q | 4291B +16193A | Keysight Technologies |
| Self-resonant frequency | 8720C | Keysight Technologies |
| DC resistance | Type-7561 | Yokogawa |

* Equivalent measurement equipment may be used.

MLG1005S type

CHARACTERISTICS SPECIFICATION TABLE

| L (nH) | Tolerance | Q min. | L, Q measuring frequency (MHz) | Self-resonant frequency | | DC resistance | | Rated current (mA)max. | Part No.* |
|-----------|-----------|-----------|--------------------------------------|----------------------------|-----------|------------------|------------------|---------------------------|----------------------------------|
| | | | | (GHz)min. | (GHz)typ. | (Ω)max. | (Ω)typ. | | |
| 16 | $\pm 3\%$ | 8 | 100 | 2.10 | 2.7 | 0.55 | 0.32 | 400 | MLG1005S16NHTD25 |
| 16 | $\pm 5\%$ | 8 | 100 | 2.10 | 2.7 | 0.55 | 0.32 | 400 | MLG1005S16NJTD25 |
| 18 | $\pm 3\%$ | 8 | 100 | 2.00 | 2.5 | 0.60 | 0.40 | 350 | MLG1005S18NHTD25 |
| 18 | $\pm 5\%$ | 8 | 100 | 2.00 | 2.5 | 0.60 | 0.40 | 350 | MLG1005S18NJTD25 |
| 20 | $\pm 3\%$ | 8 | 100 | 1.90 | 2.4 | 0.60 | 0.38 | 350 | MLG1005S20NHTD25 |
| 20 | $\pm 5\%$ | 8 | 100 | 1.90 | 2.4 | 0.60 | 0.38 | 350 | MLG1005S20NJTD25 |
| 22 | $\pm 3\%$ | 8 | 100 | 1.70 | 2.2 | 0.70 | 0.46 | 350 | MLG1005S22NHTD25 |
| 22 | $\pm 5\%$ | 8 | 100 | 1.70 | 2.2 | 0.70 | 0.46 | 350 | MLG1005S22NJTD25 |
| 24 | $\pm 3\%$ | 8 | 100 | 1.70 | 2.1 | 0.70 | 0.43 | 350 | MLG1005S24NHTD25 |
| 24 | $\pm 5\%$ | 8 | 100 | 1.70 | 2.1 | 0.70 | 0.43 | 350 | MLG1005S24NJTD25 |
| 27 | $\pm 3\%$ | 8 | 100 | 1.60 | 2.0 | 0.80 | 0.53 | 300 | MLG1005S27NHTD25 |
| 27 | $\pm 5\%$ | 8 | 100 | 1.60 | 2.0 | 0.80 | 0.53 | 300 | MLG1005S27NJTD25 |
| 30 | $\pm 3\%$ | 8 | 100 | 1.50 | 1.9 | 0.80 | 0.50 | 300 | MLG1005S30NHTD25 |
| 30 | $\pm 5\%$ | 8 | 100 | 1.50 | 1.9 | 0.80 | 0.50 | 300 | MLG1005S30NJTD25 |
| 33 | $\pm 3\%$ | 8 | 100 | 1.40 | 1.8 | 0.90 | 0.59 | 300 | MLG1005S33NHTD25 |
| 33 | $\pm 5\%$ | 8 | 100 | 1.40 | 1.8 | 0.90 | 0.59 | 300 | MLG1005S33NJTD25 |
| 36 | $\pm 3\%$ | 8 | 100 | 1.30 | 1.7 | 1.00 | 0.62 | 250 | MLG1005S36NHTD25 |
| 36 | $\pm 5\%$ | 8 | 100 | 1.30 | 1.7 | 1.00 | 0.62 | 250 | MLG1005S36NJTD25 |
| 39 | $\pm 3\%$ | 8 | 100 | 1.20 | 1.6 | 1.00 | 0.65 | 250 | MLG1005S39NHTD25 |
| 39 | $\pm 5\%$ | 8 | 100 | 1.20 | 1.6 | 1.00 | 0.65 | 250 | MLG1005S39NJTD25 |
| 43 | $\pm 3\%$ | 8 | 100 | 1.20 | 1.6 | 1.10 | 0.67 | 250 | MLG1005S43NHTD25 |
| 43 | $\pm 5\%$ | 8 | 100 | 1.20 | 1.6 | 1.10 | 0.67 | 250 | MLG1005S43NJTD25 |
| 47 | $\pm 3\%$ | 8 | 100 | 1.10 | 1.4 | 1.20 | 0.75 | 250 | MLG1005S47NHTD25 |
| 47 | $\pm 5\%$ | 8 | 100 | 1.10 | 1.4 | 1.20 | 0.75 | 250 | MLG1005S47NJTD25 |
| 51 | $\pm 3\%$ | 8 | 100 | 1.10 | 1.5 | 1.20 | 0.72 | 250 | MLG1005S51NHTD25 |
| 51 | $\pm 5\%$ | 8 | 100 | 1.10 | 1.5 | 1.20 | 0.72 | 250 | MLG1005S51NJTD25 |
| 56 | $\pm 3\%$ | 8 | 100 | 1.00 | 1.3 | 1.30 | 0.83 | 200 | MLG1005S56NHTD25 |
| 56 | $\pm 5\%$ | 8 | 100 | 1.00 | 1.3 | 1.30 | 0.83 | 200 | MLG1005S56NJTD25 |
| 62 | $\pm 3\%$ | 8 | 100 | 1.00 | 1.3 | 1.40 | 0.85 | 200 | MLG1005S62NHTD25 |
| 62 | $\pm 5\%$ | 8 | 100 | 1.00 | 1.3 | 1.40 | 0.85 | 200 | MLG1005S62NJTD25 |
| 68 | $\pm 3\%$ | 8 | 100 | 0.80 | 1.1 | 1.50 | 0.87 | 200 | MLG1005S68NHTD25 |
| 68 | $\pm 5\%$ | 8 | 100 | 0.80 | 1.1 | 1.50 | 0.87 | 200 | MLG1005S68NJTD25 |
| 75 | $\pm 3\%$ | 8 | 100 | 0.75 | 1.1 | 1.50 | 0.93 | 200 | MLG1005S75NHTD25 |
| 75 | $\pm 5\%$ | 8 | 100 | 0.75 | 1.1 | 1.50 | 0.93 | 200 | MLG1005S75NJTD25 |
| 82 | $\pm 3\%$ | 8 | 100 | 0.70 | 1.0 | 1.60 | 1.01 | 200 | MLG1005S82NHTD25 |
| 82 | $\pm 5\%$ | 8 | 100 | 0.70 | 1.0 | 1.60 | 1.01 | 200 | MLG1005S82NJTD25 |
| 91 | $\pm 3\%$ | 8 | 100 | 0.70 | 0.9 | 1.80 | 1.14 | 200 | MLG1005S91NHTD25 |
| 91 | $\pm 5\%$ | 8 | 100 | 0.70 | 0.9 | 1.80 | 1.14 | 200 | MLG1005S91NJTD25 |
| 100 | $\pm 3\%$ | 8 | 100 | 0.70 | 0.9 | 2.00 | 1.37 | 200 | MLG1005SR10HTD25 |
| 100 | $\pm 5\%$ | 8 | 100 | 0.70 | 0.9 | 2.00 | 1.37 | 200 | MLG1005SR10JTD25 |
| 110 | $\pm 3\%$ | 8 | 100 | 0.70 | 0.9 | 2.20 | 1.48 | 150 | MLG1005SR11HTD25 |
| 110 | $\pm 5\%$ | 8 | 100 | 0.70 | 0.9 | 2.20 | 1.48 | 150 | MLG1005SR11JTD25 |
| 120 | $\pm 3\%$ | 8 | 100 | 0.60 | 0.8 | 2.20 | 1.48 | 150 | MLG1005SR12HTD25 |
| 120 | $\pm 5\%$ | 8 | 100 | 0.60 | 0.8 | 2.20 | 1.48 | 150 | MLG1005SR12JTD25 |

* Please contact us for information on inductance tolerance, G ($\pm 2\%$).

Measurement equipment

| Measurement item | Product No. | Manufacturer |
|-------------------------|---------------|-----------------------|
| L, Q | 4291B +16193A | Keysight Technologies |
| Self-resonant frequency | 8720C | Keysight Technologies |
| DC resistance | Type-7561 | Yokogawa |

* Equivalent measurement equipment may be used.

MLG1005S type

CHARACTERISTICS SPECIFICATION TABLE

| L (nH) | Tolerance | Q min. | L, Q measuring frequency (MHz) | Self-resonant frequency | | DC resistance | | Rated current (mA)max. | Part No.* |
|-----------|-----------|-----------|--------------------------------------|----------------------------|-----------|------------------|------------------|---------------------------|----------------------------------|
| | | | | (GHz)min. | (GHz)typ. | (Ω)max. | (Ω)typ. | | |
| 130 | $\pm 3\%$ | 8 | 100 | 0.60 | 0.8 | 2.50 | 1.68 | 150 | MLG1005SR13HTD25 |
| 130 | $\pm 5\%$ | 8 | 100 | 0.60 | 0.8 | 2.50 | 1.68 | 150 | MLG1005SR13JTD25 |
| 150 | $\pm 3\%$ | 8 | 100 | 0.55 | 0.7 | 3.50 | 2.44 | 150 | MLG1005SR15HTD25 |
| 150 | $\pm 5\%$ | 8 | 100 | 0.55 | 0.7 | 3.50 | 2.44 | 150 | MLG1005SR15JTD25 |
| 160 | $\pm 3\%$ | 8 | 100 | 0.50 | 0.6 | 3.80 | 2.74 | 150 | MLG1005SR16HTD25 |
| 160 | $\pm 5\%$ | 8 | 100 | 0.50 | 0.6 | 3.80 | 2.74 | 150 | MLG1005SR16JTD25 |
| 180 | $\pm 3\%$ | 8 | 100 | 0.50 | 0.6 | 3.80 | 2.88 | 150 | MLG1005SR18HTD25 |
| 180 | $\pm 5\%$ | 8 | 100 | 0.50 | 0.6 | 3.80 | 2.88 | 150 | MLG1005SR18JTD25 |
| 200 | $\pm 3\%$ | 8 | 100 | 0.42 | 0.5 | 4.20 | 3.15 | 100 | MLG1005SR20HTD25 |
| 200 | $\pm 5\%$ | 8 | 100 | 0.42 | 0.5 | 4.20 | 3.15 | 100 | MLG1005SR20JTD25 |
| 220 | $\pm 3\%$ | 8 | 100 | 0.45 | 0.5 | 4.20 | 3.02 | 100 | MLG1005SR22HTD25 |
| 220 | $\pm 5\%$ | 8 | 100 | 0.45 | 0.5 | 4.20 | 3.02 | 100 | MLG1005SR22JTD25 |
| 240 | $\pm 3\%$ | 8 | 100 | 0.40 | 0.5 | 4.80 | 3.42 | 100 | MLG1005SR24HTD25 |
| 240 | $\pm 5\%$ | 8 | 100 | 0.40 | 0.5 | 4.80 | 3.42 | 100 | MLG1005SR24JTD25 |
| 270 | $\pm 3\%$ | 8 | 100 | 0.40 | 0.5 | 4.80 | 3.54 | 100 | MLG1005SR27HTD25 |
| 270 | $\pm 5\%$ | 8 | 100 | 0.40 | 0.5 | 4.80 | 3.54 | 100 | MLG1005SR27JTD25 |
| 300 | $\pm 3\%$ | 6 | 50 | 0.35 | 0.4 | 6.50 | 4.82 | 50 | MLG1005SR30HTD25 |
| 300 | $\pm 5\%$ | 6 | 50 | 0.35 | 0.4 | 6.50 | 4.82 | 50 | MLG1005SR30JTD25 |
| 330 | $\pm 3\%$ | 6 | 50 | 0.35 | 0.4 | 7.00 | 5.21 | 50 | MLG1005SR33HTD25 |
| 330 | $\pm 5\%$ | 6 | 50 | 0.35 | 0.4 | 7.00 | 5.21 | 50 | MLG1005SR33JTD25 |
| 360 | $\pm 3\%$ | 6 | 50 | 0.30 | 0.4 | 7.50 | 5.39 | 50 | MLG1005SR36HTD25 |
| 360 | $\pm 5\%$ | 6 | 50 | 0.30 | 0.4 | 7.50 | 5.39 | 50 | MLG1005SR36JTD25 |
| 390 | $\pm 3\%$ | 6 | 50 | 0.30 | 0.4 | 8.00 | 5.97 | 50 | MLG1005SR39HTD25 |
| 390 | $\pm 5\%$ | 6 | 50 | 0.30 | 0.4 | 8.00 | 5.97 | 50 | MLG1005SR39JTD25 |

* Please contact us for information on inductance tolerance, G ($\pm 2\%$).

Measurement equipment

| Measurement item | Product No. | Manufacturer |
|-------------------------|---------------|-----------------------|
| L, Q | 4291B +16193A | Keysight Technologies |
| Self-resonant frequency | 8720C | Keysight Technologies |
| DC resistance | Type-7561 | Yokogawa |

* Equivalent measurement equipment may be used.

MLG1005S type

L, Q FREQUENCY CHARACTERISTICS TABLE

| L(nH)typ. | | | | | Q typ. | | | | | Part No.* |
|-----------|--------|--------|--------|--------|--------|--------|--------|--------|--------|----------------------------------|
| 500MHz | 800MHz | 1.8GHz | 2.0GHz | 2.4GHz | 500MHz | 800MHz | 1.8GHz | 2.0GHz | 2.4GHz | |
| 0.3 | 0.3 | 0.3 | 0.3 | 0.3 | 22min. | 27min. | 46min. | 49min. | 53min. | MLG1005S0N3BTD25 |
| 0.3 | 0.3 | 0.3 | 0.3 | 0.3 | 22min. | 27min. | 46min. | 49min. | 53min. | MLG1005S0N3CTD25 |
| 0.4 | 0.4 | 0.4 | 0.4 | 0.4 | 22min. | 27min. | 46min. | 49min. | 53min. | MLG1005S0N4BTD25 |
| 0.4 | 0.4 | 0.4 | 0.4 | 0.4 | 22min. | 27min. | 46min. | 49min. | 53min. | MLG1005S0N4CTD25 |
| 0.5 | 0.5 | 0.5 | 0.5 | 0.5 | 22min. | 27min. | 46min. | 49min. | 53min. | MLG1005S0N5BTD25 |
| 0.5 | 0.5 | 0.5 | 0.5 | 0.5 | 22min. | 27min. | 46min. | 49min. | 53min. | MLG1005S0N5CTD25 |
| 0.6 | 0.6 | 0.6 | 0.6 | 0.6 | 22 | 27 | 46 | 49 | 53 | MLG1005S0N6BTD25 |
| 0.6 | 0.6 | 0.6 | 0.6 | 0.6 | 22 | 27 | 46 | 49 | 53 | MLG1005S0N6CTD25 |
| 0.7 | 0.7 | 0.7 | 0.7 | 0.7 | 22 | 28 | 45 | 49 | 54 | MLG1005S0N7BTD25 |
| 0.7 | 0.7 | 0.7 | 0.7 | 0.7 | 22 | 28 | 45 | 49 | 54 | MLG1005S0N7CTD25 |
| 0.8 | 0.8 | 0.8 | 0.8 | 0.8 | 26 | 34 | 57 | 60 | 66 | MLG1005S0N8BTD25 |
| 0.8 | 0.8 | 0.8 | 0.8 | 0.8 | 26 | 34 | 57 | 60 | 66 | MLG1005S0N8CTD25 |
| 0.9 | 0.8 | 0.8 | 0.8 | 0.8 | 21 | 27 | 44 | 47 | 53 | MLG1005S0N9BTD25 |
| 0.9 | 0.8 | 0.8 | 0.8 | 0.8 | 21 | 27 | 44 | 47 | 53 | MLG1005S0N9CTD25 |
| 0.9 | 0.9 | 0.9 | 0.9 | 0.9 | 22 | 29 | 48 | 50 | 56 | MLG1005S1N0BTD25 |
| 0.9 | 0.9 | 0.9 | 0.9 | 0.9 | 22 | 29 | 48 | 50 | 56 | MLG1005S1N0CTD25 |
| 1.0 | 1.0 | 1.0 | 1.0 | 1.0 | 23 | 29 | 47 | 50 | 57 | MLG1005S1N1BTD25 |
| 1.0 | 1.0 | 1.0 | 1.0 | 1.0 | 23 | 29 | 47 | 50 | 57 | MLG1005S1N1CTD25 |
| 1.0 | 1.0 | 1.0 | 1.0 | 1.0 | 23 | 29 | 47 | 50 | 57 | MLG1005S1N1STD25 |
| 1.1 | 1.1 | 1.1 | 1.1 | 1.1 | 23 | 29 | 48 | 50 | 56 | MLG1005S1N2BTD25 |
| 1.1 | 1.1 | 1.1 | 1.1 | 1.1 | 23 | 29 | 48 | 50 | 56 | MLG1005S1N2CTD25 |
| 1.1 | 1.1 | 1.1 | 1.1 | 1.1 | 23 | 29 | 48 | 50 | 56 | MLG1005S1N2STD25 |
| 1.2 | 1.2 | 1.2 | 1.2 | 1.2 | 22 | 27 | 44 | 47 | 53 | MLG1005S1N3BTD25 |
| 1.2 | 1.2 | 1.2 | 1.2 | 1.2 | 22 | 27 | 44 | 47 | 53 | MLG1005S1N3CTD25 |
| 1.2 | 1.2 | 1.2 | 1.2 | 1.2 | 22 | 27 | 44 | 47 | 53 | MLG1005S1N3STD25 |
| 1.4 | 1.4 | 1.4 | 1.5 | 1.5 | 23 | 29 | 47 | 50 | 56 | MLG1005S1N5BTD25 |
| 1.4 | 1.4 | 1.4 | 1.5 | 1.5 | 23 | 29 | 47 | 50 | 56 | MLG1005S1N5CTD25 |
| 1.4 | 1.4 | 1.4 | 1.5 | 1.5 | 23 | 29 | 47 | 50 | 56 | MLG1005S1N5STD25 |
| 1.5 | 1.5 | 1.5 | 1.6 | 1.6 | 23 | 29 | 46 | 49 | 54 | MLG1005S1N6BTD25 |
| 1.5 | 1.5 | 1.5 | 1.6 | 1.6 | 23 | 29 | 46 | 49 | 54 | MLG1005S1N6CTD25 |
| 1.5 | 1.5 | 1.5 | 1.6 | 1.6 | 23 | 29 | 46 | 49 | 54 | MLG1005S1N6STD25 |
| 1.7 | 1.7 | 1.7 | 1.7 | 1.7 | 20 | 26 | 41 | 43 | 49 | MLG1005S1N8BTD25 |
| 1.7 | 1.7 | 1.7 | 1.7 | 1.7 | 20 | 26 | 41 | 43 | 49 | MLG1005S1N8CTD25 |
| 1.7 | 1.7 | 1.7 | 1.7 | 1.7 | 20 | 26 | 41 | 43 | 49 | MLG1005S1N8STD25 |
| 1.9 | 1.9 | 1.9 | 1.9 | 1.9 | 21 | 25 | 41 | 43 | 48 | MLG1005S2N0BTD25 |
| 1.9 | 1.9 | 1.9 | 1.9 | 1.9 | 21 | 25 | 41 | 43 | 48 | MLG1005S2N0CTD25 |
| 1.9 | 1.9 | 1.9 | 1.9 | 1.9 | 21 | 25 | 41 | 43 | 48 | MLG1005S2N0STD25 |
| 2.1 | 2.1 | 2.1 | 2.1 | 2.2 | 22 | 27 | 44 | 47 | 52 | MLG1005S2N2BTD25 |
| 2.1 | 2.1 | 2.1 | 2.1 | 2.2 | 22 | 27 | 44 | 47 | 52 | MLG1005S2N2CTD25 |
| 2.1 | 2.1 | 2.1 | 2.1 | 2.2 | 22 | 27 | 44 | 47 | 52 | MLG1005S2N2STD25 |

* Please contact us for information on inductance tolerance, G ($\pm 2\%$).

Measurement equipment

| Product No. | Manufacturer |
|---------------|-----------------------|
| 4291B +16193A | Keysight Technologies |

* Equivalent measurement equipment may be used.

MLG1005S type

L, Q FREQUENCY CHARACTERISTICS TABLE

| L(nH)typ. | | | | | Q typ. | | | | | Part No.* |
|-----------|--------|--------|--------|--------|--------|--------|--------|--------|--------|----------------------------------|
| 500MHz | 800MHz | 1.8GHz | 2.0GHz | 2.4GHz | 500MHz | 800MHz | 1.8GHz | 2.0GHz | 2.4GHz | |
| 2.3 | 2.3 | 2.3 | 2.3 | 2.4 | 21 | 26 | 42 | 44 | 49 | MLG1005S2N4BTD25 |
| 2.3 | 2.3 | 2.3 | 2.3 | 2.4 | 21 | 26 | 42 | 44 | 49 | MLG1005S2N4CTD25 |
| 2.3 | 2.3 | 2.3 | 2.3 | 2.4 | 21 | 26 | 42 | 44 | 49 | MLG1005S2N4STD25 |
| 2.6 | 2.6 | 2.6 | 2.7 | 2.7 | 22 | 27 | 43 | 45 | 50 | MLG1005S2N7BTD25 |
| 2.6 | 2.6 | 2.6 | 2.7 | 2.7 | 22 | 27 | 43 | 45 | 50 | MLG1005S2N7CTD25 |
| 2.6 | 2.6 | 2.6 | 2.7 | 2.7 | 22 | 27 | 43 | 45 | 50 | MLG1005S2N7STD25 |
| 2.9 | 2.9 | 3.0 | 3.0 | 3.1 | 24 | 29 | 47 | 49 | 54 | MLG1005S3N0BTD25 |
| 2.9 | 2.9 | 3.0 | 3.0 | 3.1 | 24 | 29 | 47 | 49 | 54 | MLG1005S3N0CTD25 |
| 2.9 | 2.9 | 3.0 | 3.0 | 3.1 | 24 | 29 | 47 | 49 | 54 | MLG1005S3N0STD25 |
| 3.2 | 3.2 | 3.3 | 3.4 | 3.5 | 24 | 30 | 46 | 48 | 53 | MLG1005S3N3BTD25 |
| 3.2 | 3.2 | 3.3 | 3.4 | 3.5 | 24 | 30 | 46 | 48 | 53 | MLG1005S3N3CTD25 |
| 3.2 | 3.2 | 3.3 | 3.4 | 3.5 | 24 | 30 | 46 | 48 | 53 | MLG1005S3N3STD25 |
| 3.4 | 3.4 | 3.6 | 3.6 | 3.8 | 21 | 26 | 40 | 42 | 46 | MLG1005S3N6BTD25 |
| 3.4 | 3.4 | 3.6 | 3.6 | 3.8 | 21 | 26 | 40 | 42 | 46 | MLG1005S3N6CTD25 |
| 3.4 | 3.4 | 3.6 | 3.6 | 3.8 | 21 | 26 | 40 | 42 | 46 | MLG1005S3N6STD25 |
| 3.7 | 3.7 | 3.9 | 3.9 | 4.1 | 22 | 28 | 43 | 45 | 50 | MLG1005S3N9BTD25 |
| 3.7 | 3.7 | 3.9 | 3.9 | 4.1 | 22 | 28 | 43 | 45 | 50 | MLG1005S3N9CTD25 |
| 3.7 | 3.7 | 3.9 | 3.9 | 4.1 | 22 | 28 | 43 | 45 | 50 | MLG1005S3N9STD25 |
| 4.1 | 4.1 | 4.3 | 4.4 | 4.6 | 24 | 30 | 47 | 49 | 53 | MLG1005S4N3CTD25 |
| 4.1 | 4.1 | 4.3 | 4.4 | 4.6 | 24 | 30 | 47 | 49 | 53 | MLG1005S4N3STD25 |
| 4.5 | 4.5 | 4.8 | 4.9 | 5.2 | 23 | 30 | 45 | 47 | 50 | MLG1005S4N7CTD25 |
| 4.5 | 4.5 | 4.8 | 4.9 | 5.2 | 23 | 30 | 45 | 47 | 50 | MLG1005S4N7STD25 |
| 4.9 | 4.9 | 5.4 | 5.6 | 6.1 | 23 | 29 | 42 | 43 | 44 | MLG1005S5N1CTD25 |
| 4.9 | 4.9 | 5.4 | 5.6 | 6.1 | 23 | 29 | 42 | 43 | 44 | MLG1005S5N1STD25 |
| 5.4 | 5.4 | 5.8 | 5.9 | 6.3 | 22 | 28 | 42 | 43 | 45 | MLG1005S5N6CTD25 |
| 5.4 | 5.4 | 5.8 | 5.9 | 6.3 | 22 | 28 | 42 | 43 | 45 | MLG1005S5N6STD25 |
| 6.0 | 6.0 | 6.8 | 7.1 | 7.8 | 24 | 29 | 42 | 43 | 43 | MLG1005S6N2HTD25 |
| 6.0 | 6.0 | 6.8 | 7.1 | 7.8 | 24 | 29 | 42 | 43 | 43 | MLG1005S6N2STD25 |
| 6.5 | 6.6 | 7.4 | 7.8 | 8.6 | 23 | 28 | 40 | 41 | 41 | MLG1005S6N8HTD25 |
| 6.5 | 6.6 | 7.4 | 7.8 | 8.6 | 23 | 28 | 40 | 41 | 41 | MLG1005S6N8JTD25 |
| 7.2 | 7.4 | 8.6 | 9.2 | 10.5 | 24 | 30 | 41 | 41 | 39 | MLG1005S7N5HTD25 |
| 7.2 | 7.4 | 8.6 | 9.2 | 10.5 | 24 | 30 | 41 | 41 | 39 | MLG1005S7N5JTD25 |
| 7.9 | 8.0 | 9.3 | 9.9 | 11.3 | 23 | 28 | 38 | 38 | 36 | MLG1005S8N2HTD25 |
| 7.9 | 8.0 | 9.3 | 9.9 | 11.3 | 23 | 28 | 38 | 38 | 36 | MLG1005S8N2JTD25 |
| 8.8 | 9.0 | 10.8 | 11.6 | 13.7 | 24 | 30 | 40 | 39 | 36 | MLG1005S9N1HTD25 |
| 8.8 | 9.0 | 10.8 | 11.6 | 13.7 | 24 | 30 | 40 | 39 | 36 | MLG1005S9N1JTD25 |
| 9.7 | 9.9 | 12.4 | 13.5 | 16.7 | 24 | 30 | 37 | 36 | 31 | MLG1005S10NHTD25 |
| 9.7 | 9.9 | 12.4 | 13.5 | 16.7 | 24 | 30 | 37 | 36 | 31 | MLG1005S10NJTD25 |
| 10.6 | 10.9 | 13.8 | 15.1 | 19 | 23 | 28 | 34 | 33 | 28 | MLG1005S11NHTD25 |
| 10.6 | 10.9 | 13.8 | 15.1 | 19 | 23 | 28 | 34 | 33 | 28 | MLG1005S11NJTD25 |
| 11.7 | 12.1 | 16.2 | 18.3 | | 23 | 29 | 33 | 31 | | MLG1005S12NHTD25 |
| 11.7 | 12.1 | 16.2 | 18.3 | | 23 | 29 | 33 | 31 | | MLG1005S12NJTD25 |

* Please contact us for information on inductance tolerance, G ($\pm 2\%$).

Measurement equipment

| Product No. | Manufacturer |
|---------------|-----------------------|
| 4291B +16193A | Keysight Technologies |

* Equivalent measurement equipment may be used.

MLG1005S type

L, Q FREQUENCY CHARACTERISTICS TABLE

| L(nH)typ. | | | | | Q typ. | | | | | Part No.* |
|-----------|--------|--------|--------|--------|--------|--------|--------|--------|--------|----------------------------------|
| 500MHz | 800MHz | 1.8GHz | 2.0GHz | 2.4GHz | 500MHz | 800MHz | 1.8GHz | 2.0GHz | 2.4GHz | |
| 12.6 | 13.0 | 18.3 | 21.3 | | 20 | 24 | 25 | 22 | | MLG1005S13NHTD25 |
| 12.6 | 13.0 | 18.3 | 21.3 | | 20 | 24 | 25 | 22 | | MLG1005S13NJTD25 |
| 14.7 | 15.3 | 22.0 | 26.0 | | 23 | 28 | 29 | 26 | | MLG1005S15NHTD25 |
| 14.7 | 15.3 | 22.0 | 26.0 | | 23 | 28 | 29 | 26 | | MLG1005S15NJTD25 |
| 15.6 | 16.2 | 24.1 | 29.0 | | 22 | 26 | 26 | 22 | | MLG1005S16NHTD25 |
| 15.6 | 16.2 | 24.1 | 29.0 | | 22 | 26 | 26 | 22 | | MLG1005S16NJTD25 |
| 17.7 | 18.6 | 29.0 | | | 23 | 28 | 26 | | | MLG1005S18NHTD25 |
| 17.7 | 18.6 | 29.0 | | | 23 | 28 | 26 | | | MLG1005S18NJTD25 |
| 19.7 | 20.8 | 36.8 | | | 21 | 25 | 21 | | | MLG1005S20NHTD25 |
| 19.7 | 20.8 | 36.8 | | | 21 | 25 | 21 | | | MLG1005S20NJTD25 |
| 21.8 | 23.3 | | | | 22 | 27 | | | | MLG1005S22NHTD25 |
| 21.8 | 23.3 | | | | 22 | 27 | | | | MLG1005S22NJTD25 |
| 23.8 | 25.5 | | | | 22 | 26 | | | | MLG1005S24NHTD25 |
| 23.8 | 25.5 | | | | 22 | 26 | | | | MLG1005S24NJTD25 |
| 27.0 | 29.6 | | | | 20 | 23 | | | | MLG1005S27NHTD25 |
| 27.0 | 29.6 | | | | 20 | 23 | | | | MLG1005S27NJTD25 |
| 30.1 | 33.5 | | | | 19 | 21 | | | | MLG1005S30NHTD25 |
| 30.1 | 33.5 | | | | 19 | 21 | | | | MLG1005S30NJTD25 |
| 33.5 | 37.8 | | | 20 | 23 | | | | | MLG1005S33NHTD25 |
| 33.5 | 37.8 | | | 20 | 23 | | | | | MLG1005S33NJTD25 |
| 36.7 | 41.5 | | | 21 | 23 | | | | | MLG1005S36NHTD25 |
| 36.7 | 41.5 | | | 21 | 23 | | | | | MLG1005S36NJTD25 |
| 40.3 | 46.9 | | | 20 | 21 | | | | | MLG1005S39NHTD25 |
| 40.3 | 46.9 | | | 20 | 21 | | | | | MLG1005S39NJTD25 |
| 44.3 | 51.6 | | | 20 | 21 | | | | | MLG1005S43NHTD25 |
| 44.3 | 51.6 | | | 20 | 21 | | | | | MLG1005S43NJTD25 |
| 50.2 | 63.2 | | | 19 | 20 | | | | | MLG1005S47NHTD25 |
| 50.2 | 63.2 | | | 19 | 20 | | | | | MLG1005S47NJTD25 |
| 53.7 | 65.6 | | | 19 | 19 | | | | | MLG1005S51NHTD25 |
| 53.7 | 65.6 | | | 19 | 19 | | | | | MLG1005S51NJTD25 |
| 60.9 | 80.2 | | | 19 | 18 | | | | | MLG1005S56NHTD25 |
| 60.9 | 80.2 | | | 19 | 18 | | | | | MLG1005S56NJTD25 |
| 67.5 | 89.8 | | | 18 | 16 | | | | | MLG1005S62NHTD25 |
| 67.5 | 89.8 | | | 18 | 16 | | | | | MLG1005S62NJTD25 |
| 75.8 | 107.5 | | | 17 | 15 | | | | | MLG1005S68NHTD25 |
| 75.8 | 107.5 | | | 17 | 15 | | | | | MLG1005S68NJTD25 |
| 86.5 | 135.2 | | | 17 | 13 | | | | | MLG1005S75NHTD25 |
| 86.5 | 135.2 | | | 17 | 13 | | | | | MLG1005S75NJTD25 |
| 96.9 | | | | 16 | | | | | | MLG1005S82NHTD25 |
| 96.9 | | | | 16 | | | | | | MLG1005S82NJTD25 |
| 111.0 | | | | 15 | | | | | | MLG1005S91NHTD25 |
| 111.0 | | | | 15 | | | | | | MLG1005S91NJTD25 |

* Please contact us for information on inductance tolerance, G ($\pm 2\%$).

Measurement equipment

| Product No. | Manufacturer |
|---------------|-----------------------|
| 4291B +16193A | Keysight Technologies |

* Equivalent measurement equipment may be used.

MLG1005S type

L, Q FREQUENCY CHARACTERISTICS TABLE

| L(nH)typ. | | | | | Q typ. | | | | | Part No.* |
|-----------|--------|--------|--------|--------|--------|--------|--------|--------|--------|----------------------------------|
| 500MHz | 800MHz | 1.8GHz | 2.0GHz | 2.4GHz | 500MHz | 800MHz | 1.8GHz | 2.0GHz | 2.4GHz | |
| 128.9 | | | | | 14 | | | | | MLG1005SR10HTD25 |
| 128.9 | | | | | 14 | | | | | MLG1005SR10JTD25 |
| 140.8 | | | | | 15 | | | | | MLG1005SR11HTD25 |
| 140.8 | | | | | 15 | | | | | MLG1005SR11JTD25 |
| 175.2 | | | | | 12 | | | | | MLG1005SR12HTD25 |
| 175.2 | | | | | 12 | | | | | MLG1005SR12JTD25 |
| 187.8 | | | | | 13 | | | | | MLG1005SR13HTD25 |
| 187.8 | | | | | 13 | | | | | MLG1005SR13JTD25 |
| 284.7 | | | | | 11 | | | | | MLG1005SR15HTD25 |
| 284.7 | | | | | 11 | | | | | MLG1005SR15JTD25 |
| | | | | | | | | | | MLG1005SR16HTD25 |
| | | | | | | | | | | MLG1005SR16JTD25 |
| | | | | | | | | | | MLG1005SR18HTD25 |
| | | | | | | | | | | MLG1005SR18JTD25 |
| | | | | | | | | | | MLG1005SR20HTD25 |
| | | | | | | | | | | MLG1005SR20JTD25 |
| | | | | | | | | | | MLG1005SR22HTD25 |
| | | | | | | | | | | MLG1005SR22JTD25 |
| | | | | | | | | | | MLG1005SR24HTD25 |
| | | | | | | | | | | MLG1005SR24JTD25 |
| | | | | | | | | | | MLG1005SR27HTD25 |
| | | | | | | | | | | MLG1005SR27JTD25 |
| | | | | | | | | | | MLG1005SR30HTD25 |
| | | | | | | | | | | MLG1005SR30JTD25 |
| | | | | | | | | | | MLG1005SR33HTD25 |
| | | | | | | | | | | MLG1005SR33JTD25 |
| | | | | | | | | | | MLG1005SR36HTD25 |
| | | | | | | | | | | MLG1005SR36JTD25 |
| | | | | | | | | | | MLG1005SR39HTD25 |
| | | | | | | | | | | MLG1005SR39JTD25 |

* Please contact us for information on inductance tolerance, G ($\pm 2\%$).

Measurement equipment

| Product No. | Manufacturer |
|---------------|-----------------------|
| 4291B +16193A | Keysight Technologies |

* Equivalent measurement equipment may be used.

MLG1005S type

■ L FREQUENCY CHARACTERISTICS (EXAMPLE)

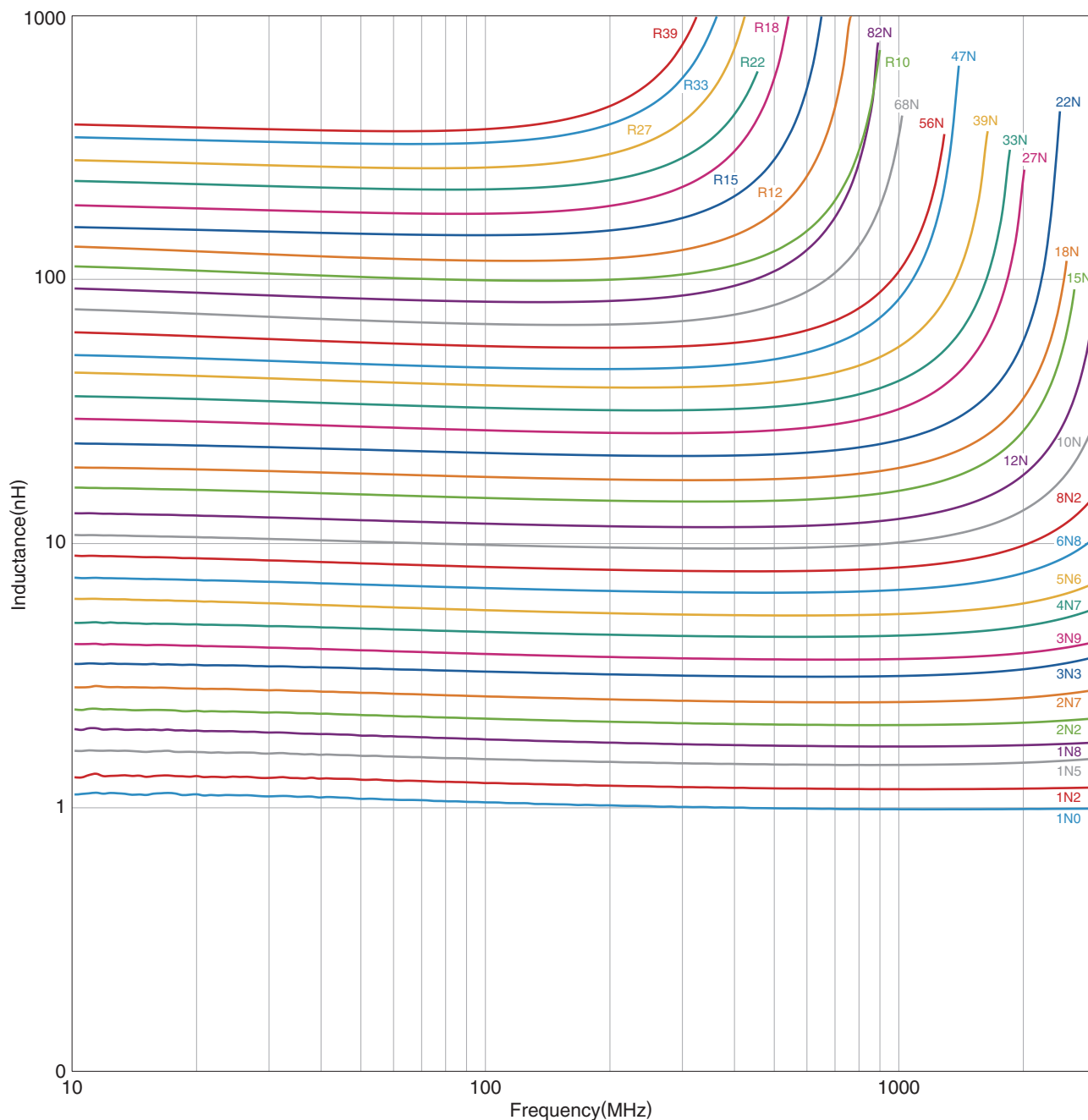

Measurement equipment

| Product No. | Manufacturer |
|----------------|-----------------------|
| E4991A +16193A | Keysight Technologies |

* Equivalent measurement equipment may be used.

MLG1005S type

Q FREQUENCY CHARACTERISTICS (EXAMPLE)

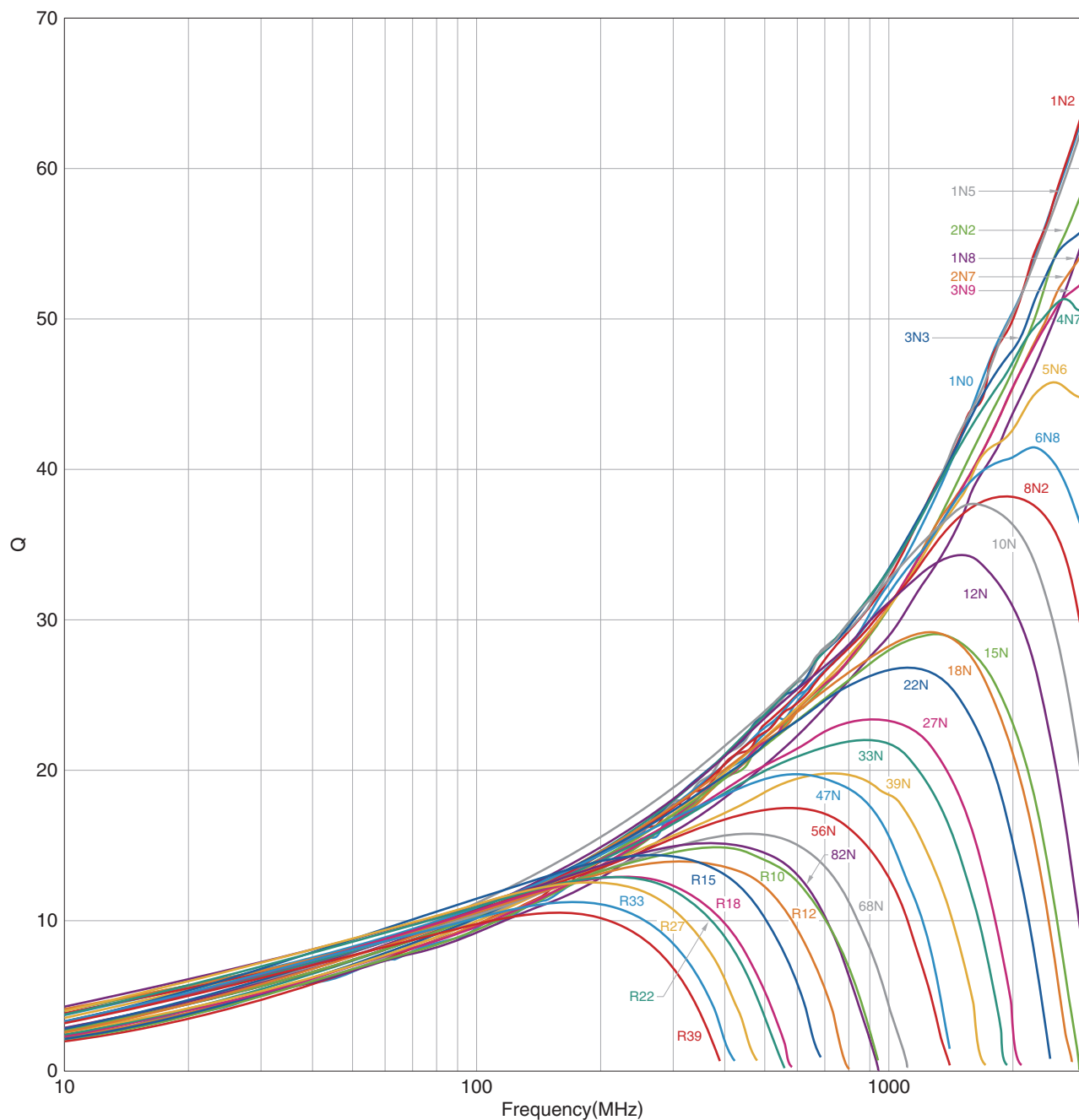

Measurement equipment

| Product No. | Manufacturer |
|----------------|-----------------------|
| E4991A +16193A | Keysight Technologies |

* Equivalent measurement equipment may be used.

MLG1005S type

SHAPE & DIMENSIONS

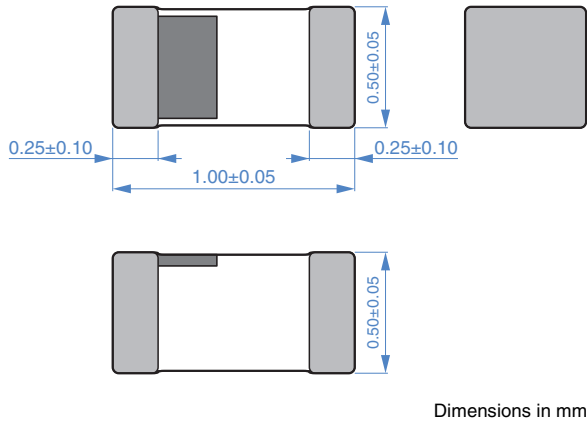

PACKAGING STYLE

REEL DIMENSIONS

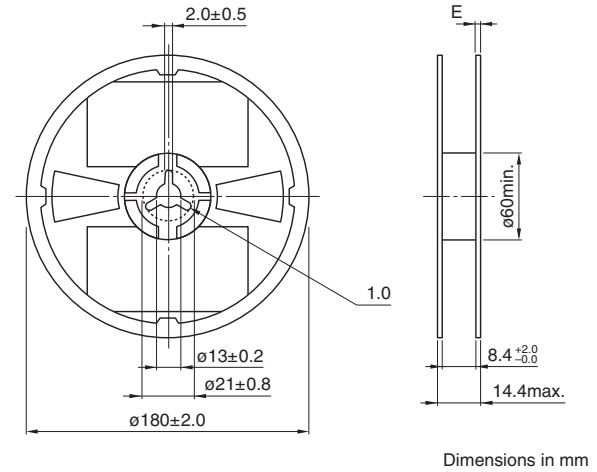

RECOMMENDED LAND PATTERN

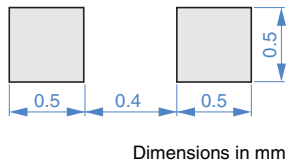

TAPE DIMENSIONS

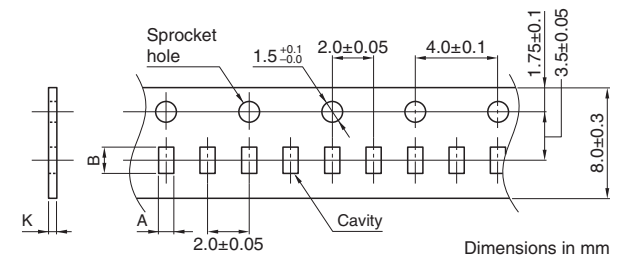

RECOMMENDED REFLOW PROFILE

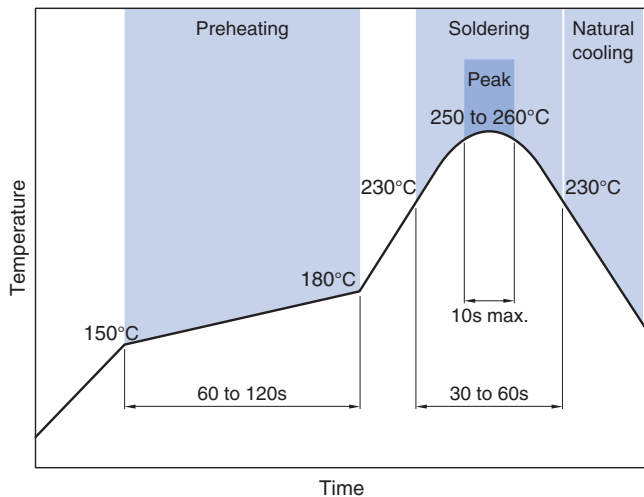

| Type | A | B | K |
|----------|----------|----------|----------|
| MLG1005S | 0.62±0.1 | 1.12±0.1 | 0.8 max. |

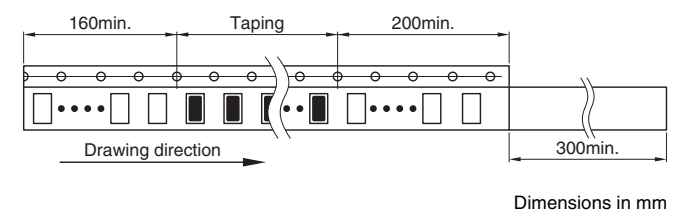

PACKAGE QUANTITY

| | |
|------------------|---------------|
| Package quantity | 10000pcs/reel |
|------------------|---------------|

TEMPERATURE RANGE, INDIVIDUAL WEIGHT

| Operating temperature range | Storage temperature range* | Individual weight |
|-----------------------------|----------------------------|-------------------|
| -55 to +125 °C | -55 to +125 °C | 1 mg |

* The storage temperature range is for after the assembly.

REMINDERS FOR USING THESE PRODUCTS

Before using these products, be sure to request the delivery specifications.

SAFETY REMINDERS

Please pay sufficient attention to the warnings for safe designing when using this products.

REMINDERS

- The storage period is less than 12 months. Be sure to follow the storage conditions (temperature: 5 to 40°C, humidity: 10 to 75% RH or less).
If the storage period elapses, the soldering of the terminal electrodes may deteriorate.
- Do not use or store in locations where there are conditions such as gas corrosion (salt, acid, alkali, etc.).
- Before soldering, be sure to preheat components.
The preheating temperature should be set so that the temperature difference between the solder temperature and chip temperature does not exceed 150°C.
- Soldering corrections after mounting should be within the range of the conditions determined in the specifications.
If overheated, a short circuit, performance deterioration, or lifespan shortening may occur.
- When embedding a printed circuit board where a chip is mounted to a set, be sure that residual stress is not given to the chip due to the overall distortion of the printed circuit board and partial distortion such as at screw tightening portions.
- Self heating (temperature increase) occurs when the power is turned ON, so the tolerance should be sufficient for the set thermal design.
- Carefully lay out the coil for the circuit board design of the non-magnetic shield type.
A malfunction may occur due to magnetic interference.
- Use a wrist band to discharge static electricity in your body through the grounding wire.
- Do not expose the products to magnets or magnetic fields.
- Do not use for a purpose outside of the contents regulated in the delivery specifications.
- The products listed on this catalog are intended for use in general electronic equipment (AV equipment, telecommunications equipment, home appliances, amusement equipment, computer equipment, personal equipment, office equipment, measurement equipment, industrial robots) under a normal operation and use condition.
The products are not designed or warranted to meet the requirements of the applications listed below, whose performance and/or quality require a more stringent level of safety or reliability, or whose failure, malfunction or trouble could cause serious damage to society, person or property.
If you intend to use the products in the applications listed below or if you have special requirements exceeding the range or conditions set forth in the each catalog, please contact us.



- (1) Aerospace/aviation equipment
- (2) Transportation equipment (electric trains, ships, etc.)
- (3) Medical equipment
- (4) Power-generation control equipment
- (5) Atomic energy-related equipment
- (6) Seabed equipment
- (7) Transportation control equipment

- (8) Public information-processing equipment
- (9) Military equipment
- (10) Electric heating apparatus, burning equipment
- (11) Disaster prevention/crime prevention equipment
- (12) Safety equipment
- (13) Other applications that are not considered general-purpose applications







When designing your equipment even for general-purpose applications, you are kindly requested to take into consideration securing protection circuit/device or providing backup circuits in your equipment.

Looking for pricing, stock, or lifecycle information?

Click below to explore more details on WIN SOURCE:

-  [View MLG1005S0N5BTD25 on WIN SOURCE](#)
-  [TDK Corporation](#) Information

Optimize Your Supply Chain with WIN SOURCE Solutions

-  Global Sourcing Solution
-  Obsolete Management
-  Cost Control Management
-  Shortage Management
-  Alternative Solution
-  Excess Inventory Management