



**THE DATASHEET OF
MLG0402Q15NHT000**



Inductors for high frequency circuits
Multilayer ceramic
MLG-Q series



MLG0402Q type



FEATURES

- High Q type inductor for high-frequency circuits.
- Inductance range: from 0.2 to 33nH.
- 0.1n step inductance lineup.
- Compared with existing products, the size was greatly reduced, making it optimal for fine-pitch circuits.
- Optimal configuration that greatly improves the Q to 800MHz or higher.
- Advanced monolithic structure is formed using a multilayering and sintering process with ceramic and conductive materials for high-frequency.
- Operating temperature range: -55 to +125°C

APPLICATION

- Smart phones, tablet terminals, high frequency modules (PAs, VCOs, FEMs , etc.), Bluetooth, W-LAN, UWB, tuners and other high frequency circuits for the mobile communication industry
- Application guides: [Smart phones/tablets](#)

PART NUMBER CONSTRUCTION

MLG	0402	Q	0N2	B	T	000
Series name	L×W×H dimensions 0.4×0.2×0.2 mm	Characteristics	Inductance (nH)	Inductance tolerance	Packaging style	Internal code

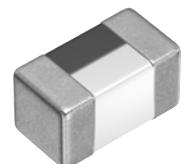

MLG0402Q type

CHARACTERISTICS SPECIFICATION TABLE

L (nH)	Q Tolerance	Q min.	L, Q measuring frequency (MHz)	Self-resonant frequency		DC resistance		Rated current (mA)max.	Part No.*
				(GHz)min.	(GHz)typ.	(Ω)max.	(Ω)typ.		
0.2	± 0.1 nH	—	100	10.0	20.0	0.10	0.03	350	MLG0402Q0N2BT000
0.2	± 0.2 nH	—	100	10.0	20.0	0.10	0.03	350	MLG0402Q0N2CT000
0.3	± 0.1 nH	—	100	10.0	18.5	0.20	0.07	350	MLG0402Q0N3BT000
0.3	± 0.2 nH	—	100	10.0	18.5	0.20	0.07	350	MLG0402Q0N3CT000
0.4	± 0.1 nH	—	100	10.0	20.0	0.20	0.08	350	MLG0402Q0N4BT000
0.4	± 0.2 nH	—	100	10.0	20.0	0.20	0.08	350	MLG0402Q0N4CT000
0.5	± 0.1 nH	—	100	10.0	20.0	0.20	0.11	350	MLG0402Q0N5BT000
0.5	± 0.2 nH	—	100	10.0	20.0	0.20	0.11	350	MLG0402Q0N5CT000
0.6	± 0.1 nH	—	100	10.0	20.0	0.30	0.13	320	MLG0402Q0N6BT000
0.6	± 0.2 nH	—	100	10.0	20.0	0.30	0.13	320	MLG0402Q0N6CT000
0.7	± 0.1 nH	—	100	10.0	20.0	0.40	0.19	320	MLG0402Q0N7BT000
0.7	± 0.2 nH	—	100	10.0	20.0	0.40	0.19	320	MLG0402Q0N7CT000
0.8	± 0.1 nH	—	100	10.0	19.5	0.40	0.11	320	MLG0402Q0N8BT000
0.8	± 0.2 nH	—	100	10.0	19.5	0.40	0.11	320	MLG0402Q0N8CT000
0.9	± 0.1 nH	—	100	10.0	20.0	0.40	0.15	320	MLG0402Q0N9BT000
0.9	± 0.2 nH	—	100	10.0	20.0	0.40	0.15	320	MLG0402Q0N9CT000
1.0	± 0.1 nH	2	100	10.0	16.8	0.40	0.20	250	MLG0402Q1N0BT000
1.0	± 0.2 nH	2	100	10.0	16.8	0.40	0.20	250	MLG0402Q1N0CT000
1.0	± 0.3 nH	2	100	10.0	16.8	0.40	0.20	250	MLG0402Q1N0ST000
1.1	± 0.1 nH	2	100	10.0	16.6	0.50	0.22	250	MLG0402Q1N1BT000
1.1	± 0.2 nH	2	100	10.0	16.6	0.50	0.22	250	MLG0402Q1N1CT000
1.1	± 0.3 nH	2	100	10.0	16.6	0.50	0.22	250	MLG0402Q1N1ST000
1.2	± 0.1 nH	2	100	10.0	16.2	0.50	0.25	250	MLG0402Q1N2BT000
1.2	± 0.2 nH	2	100	10.0	16.2	0.50	0.25	250	MLG0402Q1N2CT000
1.2	± 0.3 nH	2	100	10.0	16.2	0.50	0.25	250	MLG0402Q1N2ST000
1.3	± 0.1 nH	2	100	10.0	16.0	0.60	0.28	250	MLG0402Q1N3BT000
1.3	± 0.2 nH	2	100	10.0	16.0	0.60	0.28	250	MLG0402Q1N3CT000
1.3	± 0.3 nH	2	100	10.0	16.0	0.60	0.28	250	MLG0402Q1N3ST000
1.4	± 0.1 nH	2	100	10.0	15.8	0.60	0.30	250	MLG0402Q1N4BT000
1.4	± 0.2 nH	2	100	10.0	15.8	0.60	0.30	250	MLG0402Q1N4CT000
1.4	± 0.3 nH	2	100	10.0	15.8	0.60	0.30	250	MLG0402Q1N4ST000
1.5	± 0.1 nH	2	100	10.0	15.6	0.60	0.37	220	MLG0402Q1N5BT000
1.5	± 0.2 nH	2	100	10.0	15.6	0.60	0.37	220	MLG0402Q1N5CT000
1.5	± 0.3 nH	2	100	10.0	15.6	0.60	0.37	220	MLG0402Q1N5ST000
1.6	± 0.1 nH	2	100	10.0	14.4	0.60	0.25	220	MLG0402Q1N6BT000
1.6	± 0.2 nH	2	100	10.0	14.4	0.60	0.25	220	MLG0402Q1N6CT000
1.6	± 0.3 nH	2	100	10.0	14.4	0.60	0.25	220	MLG0402Q1N6ST000
1.7	± 0.1 nH	2	100	10.0	13.4	0.60	0.25	200	MLG0402Q1N7BT000
1.7	± 0.2 nH	2	100	10.0	13.4	0.60	0.25	200	MLG0402Q1N7CT000
1.7	± 0.3 nH	2	100	10.0	13.4	0.60	0.25	200	MLG0402Q1N7ST000
1.8	± 0.1 nH	2	100	10.0	13.9	0.60	0.28	200	MLG0402Q1N8BT000
1.8	± 0.2 nH	2	100	10.0	13.9	0.60	0.28	200	MLG0402Q1N8CT000
1.8	± 0.3 nH	2	100	10.0	13.9	0.60	0.28	200	MLG0402Q1N8ST000
1.9	± 0.1 nH	2	100	9.0	12.2	0.60	0.27	200	MLG0402Q1N9BT000
1.9	± 0.2 nH	2	100	9.0	12.2	0.60	0.27	200	MLG0402Q1N9CT000
1.9	± 0.3 nH	2	100	9.0	12.2	0.60	0.27	200	MLG0402Q1N9ST000

* Please contact us for information on inductance tolerance, G ($\pm 2\%$).

Measurement equipment

Measurement item	Product No.	Manufacturer
L, Q	4291B+16196D	Keysight Technologies
Self-resonant frequency	8720C	Keysight Technologies
DC resistance	4338A	Keysight Technologies

* Equivalent measurement equipment may be used.

MLG0402Q type

CHARACTERISTICS SPECIFICATION TABLE

L (nH)	Q Tolerance	Q min.	L, Q measuring frequency (MHz)	Self-resonant frequency		DC resistance		Rated current (mA)max.	Part No.*
				(GHz)min.	(GHz)typ.	(Ω)max.	(Ω)typ.		
2.0	± 0.1 nH	2	100	9.0	12.5	0.60	0.30	200	MLG0402Q2N0BT000
2.0	± 0.2 nH	2	100	9.0	12.5	0.60	0.30	200	MLG0402Q2N0CT000
2.0	± 0.3 nH	2	100	9.0	12.5	0.60	0.30	200	MLG0402Q2N0ST000
2.1	± 0.1 nH	2	100	8.0	11.8	0.70	0.36	200	MLG0402Q2N1BT000
2.1	± 0.2 nH	2	100	8.0	11.8	0.70	0.36	200	MLG0402Q2N1CT000
2.1	± 0.3 nH	2	100	8.0	11.8	0.70	0.36	200	MLG0402Q2N1ST000
2.2	± 0.1 nH	2	100	8.0	11.7	0.80	0.43	200	MLG0402Q2N2BT000
2.2	± 0.2 nH	2	100	8.0	11.7	0.80	0.43	200	MLG0402Q2N2CT000
2.2	± 0.3 nH	2	100	8.0	11.7	0.80	0.43	200	MLG0402Q2N2ST000
2.3	± 0.1 nH	2	100	7.0	11.0	0.80	0.46	200	MLG0402Q2N3BT000
2.3	± 0.2 nH	2	100	7.0	11.0	0.80	0.46	200	MLG0402Q2N3CT000
2.3	± 0.3 nH	2	100	7.0	11.0	0.80	0.46	200	MLG0402Q2N3ST000
2.4	± 0.1 nH	2	100	7.0	10.9	0.80	0.43	200	MLG0402Q2N4BT000
2.4	± 0.2 nH	2	100	7.0	10.9	0.80	0.43	200	MLG0402Q2N4CT000
2.4	± 0.3 nH	2	100	7.0	10.9	0.80	0.43	200	MLG0402Q2N4ST000
2.5	± 0.1 nH	2	100	7.0	10.5	0.80	0.54	200	MLG0402Q2N5BT000
2.5	± 0.2 nH	2	100	7.0	10.5	0.80	0.54	200	MLG0402Q2N5CT000
2.5	± 0.3 nH	2	100	7.0	10.5	0.80	0.54	200	MLG0402Q2N5ST000
2.6	± 0.1 nH	2	100	7.0	10.7	0.80	0.54	200	MLG0402Q2N6BT000
2.6	± 0.2 nH	2	100	7.0	10.7	0.80	0.54	200	MLG0402Q2N6CT000
2.6	± 0.3 nH	2	100	7.0	10.7	0.80	0.54	200	MLG0402Q2N6ST000
2.7	± 0.1 nH	2	100	7.0	10.7	0.80	0.54	200	MLG0402Q2N7BT000
2.7	± 0.2 nH	2	100	7.0	10.7	0.80	0.54	200	MLG0402Q2N7CT000
2.7	± 0.3 nH	2	100	7.0	10.7	0.80	0.54	200	MLG0402Q2N7ST000
2.8	± 0.1 nH	2	100	7.0	10.4	0.80	0.56	200	MLG0402Q2N8BT000
2.8	± 0.2 nH	2	100	7.0	10.4	0.80	0.56	200	MLG0402Q2N8CT000
2.8	± 0.3 nH	2	100	7.0	10.4	0.80	0.56	200	MLG0402Q2N8ST000
2.9	± 0.1 nH	2	100	7.0	10.0	0.80	0.52	200	MLG0402Q2N9BT000
2.9	± 0.2 nH	2	100	7.0	10.0	0.80	0.52	200	MLG0402Q2N9CT000
2.9	± 0.3 nH	2	100	7.0	10.0	0.80	0.52	200	MLG0402Q2N9ST000
3.0	± 0.1 nH	2	100	7.0	10.0	0.80	0.45	200	MLG0402Q3N0BT000
3.0	± 0.2 nH	2	100	7.0	10.0	0.80	0.45	200	MLG0402Q3N0CT000
3.0	± 0.3 nH	2	100	7.0	10.0	0.80	0.45	200	MLG0402Q3N0ST000
3.1	± 0.1 nH	2	100	7.0	9.7	0.90	0.58	200	MLG0402Q3N1BT000
3.1	± 0.2 nH	2	100	7.0	9.7	0.90	0.58	200	MLG0402Q3N1CT000
3.1	± 0.3 nH	2	100	7.0	9.7	0.90	0.58	200	MLG0402Q3N1ST000
3.2	± 0.1 nH	2	100	7.0	9.4	1.00	0.66	200	MLG0402Q3N2BT000
3.2	± 0.2 nH	2	100	7.0	9.4	1.00	0.66	200	MLG0402Q3N2CT000
3.2	± 0.3 nH	2	100	7.0	9.4	1.00	0.66	200	MLG0402Q3N2ST000
3.3	± 0.1 nH	2	100	7.0	10.0	1.10	0.73	180	MLG0402Q3N3BT000
3.3	± 0.2 nH	2	100	7.0	10.0	1.10	0.73	180	MLG0402Q3N3CT000
3.3	± 0.3 nH	2	100	7.0	10.0	1.10	0.73	180	MLG0402Q3N3ST000
3.4	± 0.1 nH	2	100	6.5	9.1	1.10	0.73	180	MLG0402Q3N4BT000
3.4	± 0.2 nH	2	100	6.5	9.1	1.10	0.73	180	MLG0402Q3N4CT000
3.4	± 0.3 nH	2	100	6.5	9.1	1.10	0.73	180	MLG0402Q3N4ST000
3.5	± 0.1 nH	2	100	6.0	9.0	1.10	0.74	180	MLG0402Q3N5BT000
3.5	± 0.2 nH	2	100	6.0	9.0	1.10	0.74	180	MLG0402Q3N5CT000
3.5	± 0.3 nH	2	100	6.0	9.0	1.10	0.74	180	MLG0402Q3N5ST000

* Please contact us for information on inductance tolerance, G ($\pm 2\%$).

Measurement equipment

Measurement item	Product No.	Manufacturer
L, Q	4291B+16196D	Keysight Technologies
Self-resonant frequency	8720C	Keysight Technologies
DC resistance	4338A	Keysight Technologies

* Equivalent measurement equipment may be used.

MLG0402Q type

CHARACTERISTICS SPECIFICATION TABLE

L (nH)	Q Tolerance	Q min.	L, Q measuring frequency (MHz)	Self-resonant frequency		DC resistance		Rated current (mA)max.	Part No.*
				(GHz)min.	(GHz)typ.	(Ω)max.	(Ω)typ.		
3.6	± 0.1 nH	2	100	6.0	9.0	1.10	0.75	180	MLG0402Q3N6BT000
3.6	± 0.2 nH	2	100	6.0	9.0	1.10	0.75	180	MLG0402Q3N6CT000
3.6	± 0.3 nH	2	100	6.0	9.0	1.10	0.75	180	MLG0402Q3N6ST000
3.7	± 0.1 nH	2	100	6.0	8.9	1.10	0.73	180	MLG0402Q3N7BT000
3.7	± 0.2 nH	2	100	6.0	8.9	1.10	0.73	180	MLG0402Q3N7CT000
3.7	± 0.3 nH	2	100	6.0	8.9	1.10	0.73	180	MLG0402Q3N7ST000
3.8	± 0.1 nH	2	100	6.0	8.4	1.10	0.70	180	MLG0402Q3N8BT000
3.8	± 0.2 nH	2	100	6.0	8.4	1.10	0.70	180	MLG0402Q3N8CT000
3.8	± 0.3 nH	2	100	6.0	8.4	1.10	0.70	180	MLG0402Q3N8ST000
3.9	± 0.1 nH	2	100	6.0	8.8	1.20	0.77	180	MLG0402Q3N9BT000
3.9	± 0.2 nH	2	100	6.0	8.8	1.20	0.77	180	MLG0402Q3N9CT000
3.9	± 0.3 nH	2	100	6.0	8.8	1.20	0.77	180	MLG0402Q3N9ST000
4.0	± 0.1 nH	2	100	6.0	8.4	1.20	0.71	180	MLG0402Q4N0BT000
4.0	± 0.2 nH	2	100	6.0	8.4	1.20	0.71	180	MLG0402Q4N0CT000
4.0	± 0.3 nH	2	100	6.0	8.4	1.20	0.71	180	MLG0402Q4N0ST000
4.3	± 0.3 nH	2	100	6.0	8.6	1.20	0.77	180	MLG0402Q4N3ST000
4.3	$\pm 3\%$	2	100	6.0	8.6	1.20	0.77	180	MLG0402Q4N3HT000
4.7	± 0.3 nH	2	100	6.0	8.1	1.30	0.88	160	MLG0402Q4N7ST000
4.7	$\pm 3\%$	2	100	6.0	8.1	1.30	0.88	160	MLG0402Q4N7HT000
5.1	± 0.3 nH	2	100	6.0	7.8	1.40	0.90	160	MLG0402Q5N1ST000
5.1	$\pm 3\%$	2	100	6.0	7.8	1.40	0.90	160	MLG0402Q5N1HT000
5.6	± 0.3 nH	2	100	6.0	7.8	1.50	1.02	140	MLG0402Q5N6ST000
5.6	$\pm 3\%$	2	100	6.0	7.8	1.50	1.02	140	MLG0402Q5N6HT000
6.2	± 0.3 nH	2	100	5.5	7.2	1.50	1.04	140	MLG0402Q6N2ST000
6.2	$\pm 3\%$	2	100	5.5	7.2	1.50	1.04	140	MLG0402Q6N2HT000
6.8	$\pm 3\%$	2	100	5.5	6.9	1.60	1.12	140	MLG0402Q6N8HT000
6.8	$\pm 5\%$	2	100	5.5	6.9	1.60	1.12	140	MLG0402Q6N8JT000
7.5	$\pm 3\%$	2	100	5.0	6.7	1.70	1.13	140	MLG0402Q7N5HT000
7.5	$\pm 5\%$	2	100	5.0	6.7	1.70	1.13	140	MLG0402Q7N5JT000
8.2	$\pm 3\%$	2	100	4.5	6.2	1.80	1.16	140	MLG0402Q8N2HT000
8.2	$\pm 5\%$	2	100	4.5	6.2	1.80	1.16	140	MLG0402Q8N2JT000
9.1	$\pm 3\%$	2	100	4.0	5.7	1.80	1.20	140	MLG0402Q9N1HT000
9.1	$\pm 5\%$	2	100	4.0	5.7	1.80	1.20	140	MLG0402Q9N1JT000
10.0	$\pm 3\%$	3	100	4.0	5.3	2.10	1.45	140	MLG0402Q10NHT000
10.0	$\pm 5\%$	3	100	4.0	5.3	2.10	1.45	140	MLG0402Q10NJT000
12.0	$\pm 3\%$	3	100	3.5	4.8	2.40	1.64	140	MLG0402Q12NHT000
12.0	$\pm 5\%$	3	100	3.5	4.8	2.40	1.64	140	MLG0402Q12NJT000
15.0	$\pm 3\%$	3	100	3.0	4.5	2.60	1.77	140	MLG0402Q15NHT000
15.0	$\pm 5\%$	3	100	3.0	4.5	2.60	1.77	140	MLG0402Q15NJT000
18.0	$\pm 3\%$	3	100	2.5	3.0	2.80	1.94	140	MLG0402Q18NHT000
18.0	$\pm 5\%$	3	100	2.5	3.0	2.80	1.94	140	MLG0402Q18NJT000
22.0	$\pm 3\%$	3	100	2.2	2.7	3.20	2.18	130	MLG0402Q22NHT000
22.0	$\pm 5\%$	3	100	2.2	2.7	3.20	2.18	130	MLG0402Q22NJT000
27.0	$\pm 3\%$	3	100	1.9	2.5	3.50	2.44	120	MLG0402Q27NHT000
27.0	$\pm 5\%$	3	100	1.9	2.5	3.50	2.44	120	MLG0402Q27NJT000
33.0	$\pm 3\%$	3	100	1.7	2.2	3.80	2.71	120	MLG0402Q33NHT000
33.0	$\pm 5\%$	3	100	1.7	2.2	3.80	2.71	120	MLG0402Q33NJT000

* Please contact us for information on inductance tolerance, G ($\pm 2\%$).

Measurement equipment

Measurement item	Product No.	Manufacturer
L, Q	4291B+16196D	Keysight Technologies
Self-resonant frequency	8720C	Keysight Technologies
DC resistance	4338A	Keysight Technologies

* Equivalent measurement equipment may be used.

MLG0402Q type

L, Q FREQUENCY CHARACTERISTICS TABLE

L(nH)typ.					Q typ.					Part No.*
500MHz	800MHz	1.8GHz	2.0GHz	2.4GHz	500MHz	800MHz	1.8GHz	2.0GHz	2.4GHz	
0.2	0.2	0.2	0.2	0.2	8	11	18	20	23	MLG0402Q0N2BT000
0.2	0.2	0.2	0.2	0.2	8	11	18	20	23	MLG0402Q0N2CT000
0.3	0.3	0.3	0.3	0.3	7	9	15	16	19	MLG0402Q0N3BT000
0.3	0.3	0.3	0.3	0.3	7	9	15	16	19	MLG0402Q0N3CT000
0.4	0.4	0.4	0.4	0.3	9	12	19	20	22	MLG0402Q0N4BT000
0.4	0.4	0.4	0.4	0.3	9	12	19	20	22	MLG0402Q0N4CT000
0.5	0.5	0.4	0.4	0.4	9	12	19	21	23	MLG0402Q0N5BT000
0.5	0.5	0.4	0.4	0.4	9	12	19	21	23	MLG0402Q0N5CT000
0.6	0.5	0.5	0.5	0.5	7	11	17	18	20	MLG0402Q0N6BT000
0.6	0.5	0.5	0.5	0.5	7	11	17	18	20	MLG0402Q0N6CT000
0.7	0.7	0.6	0.6	0.6	8	11	18	19	22	MLG0402Q0N7BT000
0.7	0.7	0.7	0.7	0.7	9	12	20	21	24	MLG0402Q0N8BT000
0.7	0.7	0.6	0.6	0.6	8	11	18	19	22	MLG0402Q0N7CT000
0.7	0.7	0.7	0.7	0.7	9	12	20	21	24	MLG0402Q0N8CT000
0.8	0.8	0.8	0.8	0.8	10	13	21	23	26	MLG0402Q0N9BT000
0.8	0.8	0.8	0.8	0.8	10	13	21	23	26	MLG0402Q0N9CT000
0.9	0.9	0.9	0.9	0.9	10	12	20	22	25	MLG0402Q1N0BT000
0.9	0.9	0.9	0.9	0.9	10	12	20	22	25	MLG0402Q1N0CT000
0.9	0.9	0.9	0.9	0.9	10	12	20	22	25	MLG0402Q1N0ST000
1.0	1.0	1.0	1.0	1.0	9	12	20	22	25	MLG0402Q1N1BT000
1.0	1.0	1.0	1.0	1.0	9	12	20	22	25	MLG0402Q1N1CT000
1.0	1.0	1.0	1.0	1.0	9	12	20	22	25	MLG0402Q1N1ST000
1.1	1.1	1.1	1.1	1.1	9	12	20	21	24	MLG0402Q1N2BT000
1.1	1.1	1.1	1.1	1.1	9	12	20	21	24	MLG0402Q1N2CT000
1.1	1.1	1.1	1.1	1.1	9	12	20	21	24	MLG0402Q1N2ST000
1.2	1.2	1.2	1.2	1.2	9	12	20	22	25	MLG0402Q1N3BT000
1.2	1.2	1.2	1.2	1.2	9	12	20	22	25	MLG0402Q1N3CT000
1.2	1.2	1.2	1.2	1.2	9	12	20	22	25	MLG0402Q1N3ST000
1.3	1.3	1.3	1.3	1.3	9	12	20	22	25	MLG0402Q1N4BT000
1.3	1.3	1.3	1.3	1.3	9	12	20	22	25	MLG0402Q1N4CT000
1.3	1.3	1.3	1.3	1.3	9	12	20	22	25	MLG0402Q1N4ST000
1.4	1.4	1.4	1.4	1.4	9	12	19	21	23	MLG0402Q1N5BT000
1.4	1.4	1.4	1.4	1.4	9	12	19	21	23	MLG0402Q1N5CT000
1.4	1.4	1.4	1.4	1.4	9	12	19	21	23	MLG0402Q1N5ST000
1.5	1.5	1.4	1.4	1.4	10	13	22	23	26	MLG0402Q1N6BT000
1.5	1.5	1.4	1.4	1.4	10	13	22	23	26	MLG0402Q1N6CT000
1.5	1.5	1.4	1.4	1.4	10	13	22	23	26	MLG0402Q1N6ST000
1.6	1.5	1.5	1.5	1.5	10	13	21	23	25	MLG0402Q1N7BT000
1.6	1.5	1.5	1.5	1.5	10	13	21	23	25	MLG0402Q1N7CT000
1.6	1.5	1.5	1.5	1.5	10	13	21	23	25	MLG0402Q1N7ST000
1.7	1.6	1.6	1.6	1.6	11	14	22	24	27	MLG0402Q1N8BT000
1.7	1.6	1.6	1.6	1.6	11	14	22	24	27	MLG0402Q1N8CT000
1.7	1.6	1.6	1.6	1.6	11	14	22	24	27	MLG0402Q1N8ST000

* Please contact us for information on inductance tolerance, G ($\pm 2\%$).

Measurement equipment

Product No.	Manufacturer
4291B+16196D	Keysight Technologies

* Equivalent measurement equipment may be used.

MLG0402Q type

■ L, Q FREQUENCY CHARACTERISTICS TABLE

L(nH)typ.					Q typ.					Part No.*
500MHz	800MHz	1.8GHz	2.0GHz	2.4GHz	500MHz	800MHz	1.8GHz	2.0GHz	2.4GHz	
1.8	1.8	1.7	1.7	1.7	10	14	22	24	27	MLG0402Q1N9BT000
1.8	1.8	1.7	1.7	1.7	10	14	22	24	27	MLG0402Q1N9CT000
1.8	1.8	1.7	1.7	1.7	10	14	22	24	27	MLG0402Q1N9ST000
1.9	1.8	1.8	1.8	1.8	10	13	21	23	26	MLG0402Q2N0BT000
1.9	1.8	1.8	1.8	1.8	10	13	21	23	26	MLG0402Q2N0CT000
1.9	1.8	1.8	1.8	1.8	10	13	21	23	26	MLG0402Q2N0ST000
2.0	2.0	1.9	1.9	1.9	10	14	22	24	27	MLG0402Q2N1BT000
2.0	2.0	1.9	1.9	1.9	10	14	22	24	27	MLG0402Q2N1CT000
2.0	2.0	1.9	1.9	1.9	10	14	22	24	27	MLG0402Q2N1ST000
2.1	2.1	2.0	2.0	2.0	10	14	22	24	27	MLG0402Q2N2BT000
2.1	2.1	2.0	2.0	2.0	10	14	22	24	27	MLG0402Q2N2CT000
2.1	2.1	2.0	2.0	2.0	10	14	22	24	27	MLG0402Q2N2ST000
2.2	2.2	2.1	2.1	2.2	10	13	21	23	25	MLG0402Q2N3BT000
2.2	2.2	2.1	2.1	2.2	10	13	21	23	25	MLG0402Q2N3CT000
2.2	2.2	2.1	2.1	2.2	10	13	21	23	25	MLG0402Q2N3ST000
2.3	2.3	2.2	2.2	2.2	9	13	21	22	25	MLG0402Q2N4BT000
2.3	2.3	2.2	2.2	2.2	9	13	21	22	25	MLG0402Q2N4CT000
2.3	2.3	2.2	2.2	2.2	9	13	21	22	25	MLG0402Q2N4ST000
2.4	2.4	2.3	2.3	2.4	10	13	21	22	25	MLG0402Q2N5BT000
2.4	2.4	2.3	2.3	2.4	10	13	21	22	25	MLG0402Q2N5CT000
2.4	2.4	2.3	2.3	2.4	10	13	21	22	25	MLG0402Q2N5ST000
2.5	2.5	2.4	2.4	2.4	10	13	20	22	24	MLG0402Q2N6BT000
2.5	2.5	2.4	2.4	2.4	10	13	20	22	24	MLG0402Q2N6CT000
2.5	2.5	2.4	2.4	2.4	10	13	20	22	24	MLG0402Q2N6ST000
2.5	2.5	2.5	2.5	2.5	10	13	21	23	25	MLG0402Q2N7BT000
2.5	2.5	2.5	2.5	2.5	10	13	21	23	25	MLG0402Q2N7CT000
2.5	2.5	2.5	2.5	2.5	10	13	21	23	25	MLG0402Q2N7ST000
2.6	2.6	2.6	2.6	2.6	10	13	20	22	24	MLG0402Q2N8BT000
2.6	2.6	2.6	2.6	2.6	10	13	20	22	24	MLG0402Q2N8CT000
2.6	2.6	2.6	2.6	2.6	10	13	20	22	24	MLG0402Q2N8ST000
2.7	2.7	2.7	2.7	2.7	10	13	20	21	23	MLG0402Q2N9BT000
2.7	2.7	2.7	2.7	2.7	10	13	20	21	23	MLG0402Q2N9CT000
2.7	2.7	2.7	2.7	2.7	10	13	20	21	23	MLG0402Q2N9ST000
2.8	2.8	2.7	2.7	2.8	10	13	20	21	23	MLG0402Q3N0BT000
2.8	2.8	2.7	2.7	2.8	10	13	20	21	23	MLG0402Q3N0CT000
2.8	2.8	2.7	2.7	2.8	10	13	20	21	23	MLG0402Q3N0ST000
2.9	2.9	2.9	2.9	2.9	9	12	19	21	23	MLG0402Q3N1BT000
2.9	2.9	2.9	2.9	2.9	9	12	19	21	23	MLG0402Q3N1CT000
2.9	2.9	2.9	2.9	2.9	9	12	19	21	23	MLG0402Q3N1ST000
3.0	3.0	3.0	3.0	3.0	9	12	19	20	22	MLG0402Q3N2BT000
3.0	3.0	3.0	3.0	3.0	9	12	19	20	22	MLG0402Q3N2CT000
3.0	3.0	3.0	3.0	3.0	9	12	19	20	22	MLG0402Q3N2ST000

* Please contact us for information on inductance tolerance, G ($\pm 2\%$).

Measurement equipment

Product No.	Manufacturer
4291B+16196D	Keysight Technologies

* Equivalent measurement equipment may be used.

MLG0402Q type

L, Q FREQUENCY CHARACTERISTICS TABLE

L(nH)typ.					Q typ.					Part No.*
500MHz	800MHz	1.8GHz	2.0GHz	2.4GHz	500MHz	800MHz	1.8GHz	2.0GHz	2.4GHz	
3.2	3.1	3.1	3.1	3.1	9	12	19	21	23	MLG0402Q3N3BT000
3.2	3.1	3.1	3.1	3.1	9	12	19	21	23	MLG0402Q3N3CT000
3.2	3.1	3.1	3.1	3.1	9	12	19	21	23	MLG0402Q3N3ST000
3.2	3.2	3.2	3.2	3.2	9	12	19	20	22	MLG0402Q3N4BT000
3.2	3.2	3.2	3.2	3.2	9	12	19	20	22	MLG0402Q3N4CT000
3.2	3.2	3.2	3.2	3.2	9	12	19	20	22	MLG0402Q3N4ST000
3.3	3.3	3.3	3.3	3.3	9	12	19	20	22	MLG0402Q3N5BT000
3.3	3.3	3.3	3.3	3.3	9	12	19	20	22	MLG0402Q3N5CT000
3.3	3.3	3.3	3.3	3.3	9	12	19	20	22	MLG0402Q3N5ST000
3.4	3.4	3.4	3.4	3.4	10	13	20	22	24	MLG0402Q3N6BT000
3.4	3.4	3.4	3.4	3.4	10	13	20	22	24	MLG0402Q3N6CT000
3.4	3.4	3.4	3.4	3.4	10	13	20	22	24	MLG0402Q3N6ST000
3.5	3.5	3.4	3.5	3.5	9	12	19	21	23	MLG0402Q3N7BT000
3.5	3.5	3.4	3.5	3.5	9	12	19	21	23	MLG0402Q3N7CT000
3.5	3.5	3.4	3.5	3.5	9	12	19	21	23	MLG0402Q3N7ST000
3.6	3.6	3.5	3.6	3.6	10	13	19	21	23	MLG0402Q3N8BT000
3.6	3.6	3.5	3.6	3.6	10	13	19	21	23	MLG0402Q3N8CT000
3.6	3.6	3.5	3.6	3.6	10	13	19	21	23	MLG0402Q3N8ST000
3.7	3.7	3.7	3.7	3.7	9	12	19	20	22	MLG0402Q3N9BT000
3.7	3.7	3.7	3.7	3.7	9	12	19	20	22	MLG0402Q3N9CT000
3.7	3.7	3.7	3.7	3.7	9	12	19	20	22	MLG0402Q3N9ST000
3.8	3.8	3.7	3.8	3.8	9	12	19	20	22	MLG0402Q4N0BT000
3.8	3.8	3.7	3.8	3.8	9	12	19	20	22	MLG0402Q4N0CT000
3.8	3.8	3.7	3.8	3.8	9	12	19	20	22	MLG0402Q4N0ST000
4.1	4.0	4.0	4.0	4.1	10	13	21	23	25	MLG0402Q4N3ST000
4.1	4.0	4.0	4.0	4.1	10	13	21	23	25	MLG0402Q4N3HT000
4.5	4.5	4.5	4.5	4.6	10	13	21	23	25	MLG0402Q4N7ST000
4.5	4.5	4.5	4.5	4.6	10	13	21	23	25	MLG0402Q4N7HT000
4.8	4.8	4.8	4.8	4.9	10	13	20	22	24	MLG0402Q5N1ST000
4.8	4.8	4.8	4.8	4.9	10	13	20	22	24	MLG0402Q5N1HT000
5.3	5.3	5.3	5.3	5.4	11	14	22	23	25	MLG0402Q5N6ST000
5.3	5.3	5.3	5.3	5.4	11	14	22	23	25	MLG0402Q5N6HT000
5.9	5.8	5.9	5.9	6.0	11	14	21	23	25	MLG0402Q6N2ST000
5.9	5.8	5.9	5.9	6.0	11	14	21	23	25	MLG0402Q6N2HT000
6.5	6.4	6.5	6.6	6.7	10	13	21	22	23	MLG0402Q6N8HT000
6.5	6.4	6.5	6.6	6.7	10	13	21	22	23	MLG0402Q6N8JT000
7.1	7.0	7.1	7.2	7.4	11	14	22	23	25	MLG0402Q7N5HT000
7.1	7.0	7.1	7.2	7.4	11	14	22	23	25	MLG0402Q7N5JT000
7.8	7.8	7.9	8.0	8.3	11	14	21	23	24	MLG0402Q8N2HT000
7.8	7.8	7.9	8.0	8.3	11	14	21	23	24	MLG0402Q8N2JT000
8.6	8.5	8.7	8.8	9.1	11	14	21	23	24	MLG0402Q9N1HT000
8.6	8.5	8.7	8.8	9.1	11	14	21	23	24	MLG0402Q9N1JT000

* Please contact us for information on inductance tolerance, G ($\pm 2\%$).

Measurement equipment

Product No.	Manufacturer
4291B+16196D	Keysight Technologies

* Equivalent measurement equipment may be used.

MLG0402Q type

L, Q FREQUENCY CHARACTERISTICS TABLE

L(nH)typ.					Q typ.					Part No.*
500MHz	800MHz	1.8GHz	2.0GHz	2.4GHz	500MHz	800MHz	1.8GHz	2.0GHz	2.4GHz	
9.5	9.5	9.8	9.9	10.3	11	14	21	22	23	MLG0402Q10NHT000
9.5	9.5	9.8	9.9	10.3	11	14	21	22	23	MLG0402Q10NJT000
11.4	11.4	11.9	12.2	12.8	11	13	20	21	21	MLG0402Q12NHT000
11.4	11.4	11.9	12.2	12.8	11	13	20	21	21	MLG0402Q12NJT000
14.1	14.0	14.8	15.2	16.2	11	14	20	21	21	MLG0402Q15NHT000
14.1	14.0	14.8	15.2	16.2	11	14	20	21	21	MLG0402Q15NJT000
17.0	17.2	21.3	23.3	29.2	11	13	16	16	13	MLG0402Q18NHT000
17.0	17.2	21.3	23.3	29.2	11	13	16	16	13	MLG0402Q18NJT000
20.7	21.1	28.1	32.0	45.2	10	12	13	12	9	MLG0402Q22NHT000
20.7	21.1	28.1	32.0	45.2	10	12	13	12	9	MLG0402Q22NJT000
25.3	25.7	34.1	38.9		10	12	12	11		MLG0402Q27NHT000
25.3	25.7	34.1	38.9		10	12	12	11		MLG0402Q27NJT000
31.0	32.2	52.2			10	12	10			MLG0402Q33NHT000
31.0	32.2	52.2			10	12	10			MLG0402Q33NJT000

* Please contact us for information on inductance tolerance, G ($\pm 2\%$).

Measurement equipment

Product No.	Manufacturer
4291B+16196D	Keysight Technologies

* Equivalent measurement equipment may be used.

MLG0402Q type

L FREQUENCY CHARACTERISTICS (EXAMPLE)

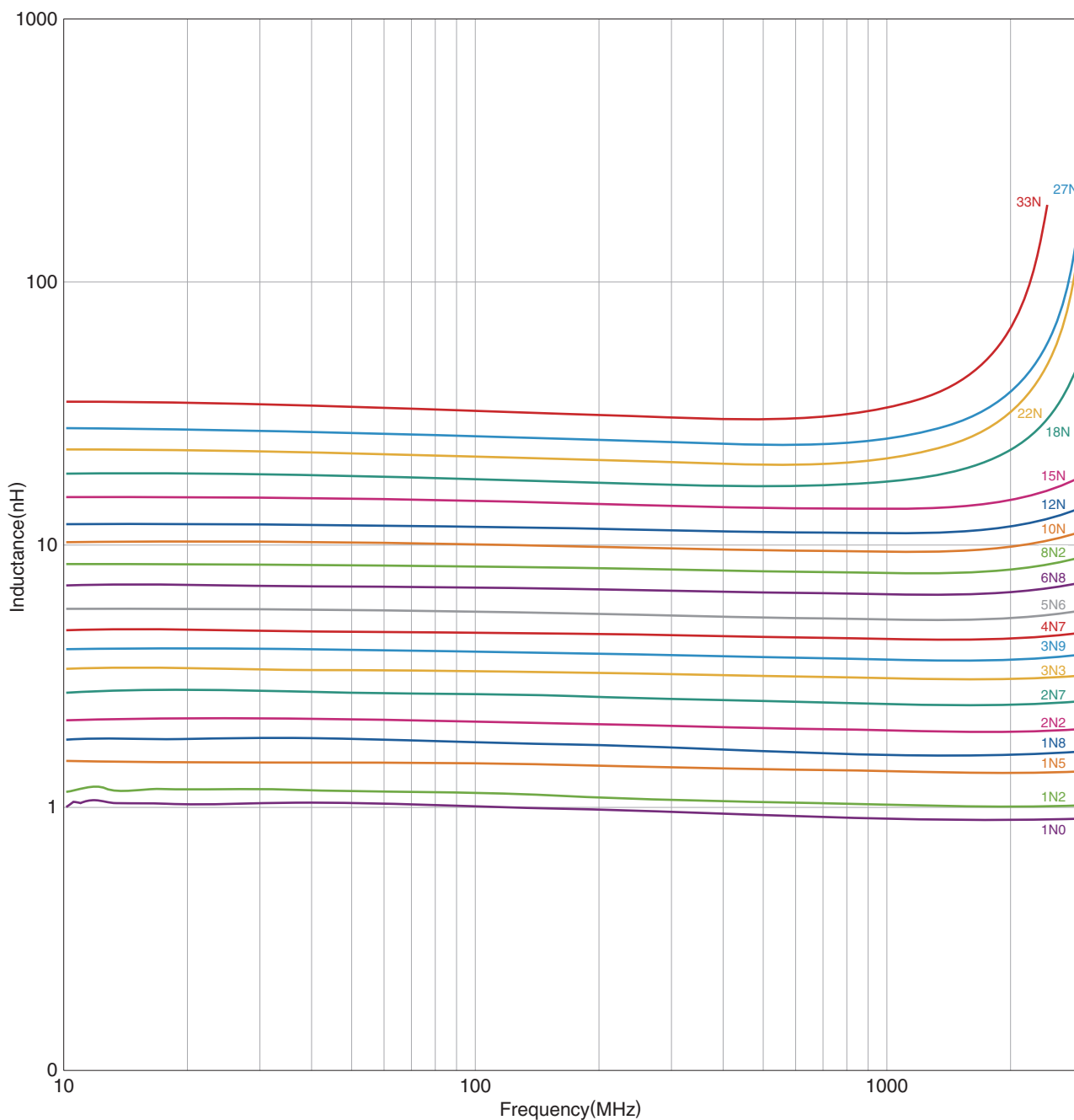

Measurement equipment

Product No.	Manufacturer
E4991A+16196D	Keysight Technologies

* Equivalent measurement equipment may be used.

MLG0402Q type

Q FREQUENCY CHARACTERISTICS (EXAMPLE)

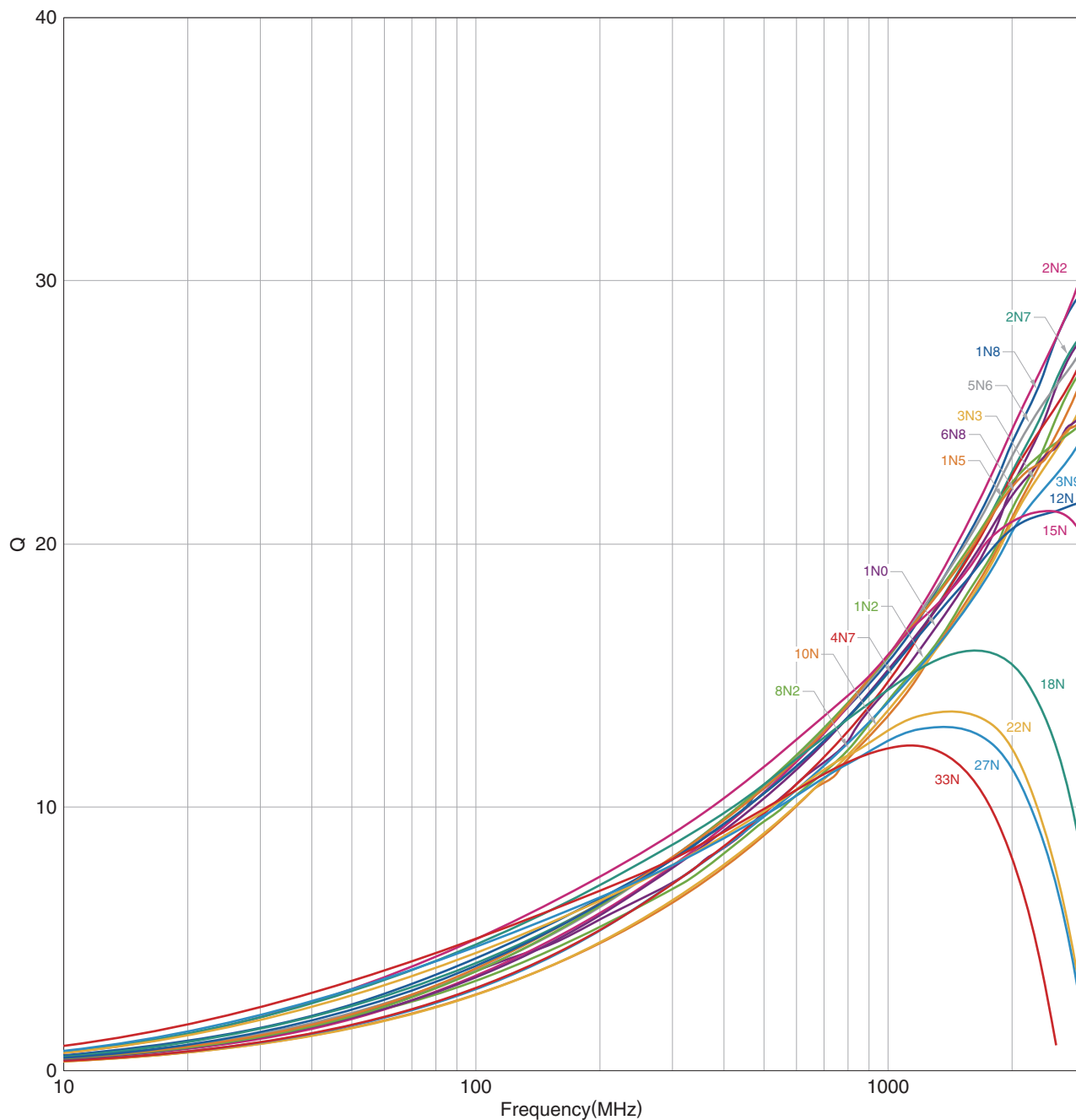

Measurement equipment

Product No.	Manufacturer
E4991A+16196D	Keysight Technologies

* Equivalent measurement equipment may be used.

MLG0402Q type

SHAPE & DIMENSIONS

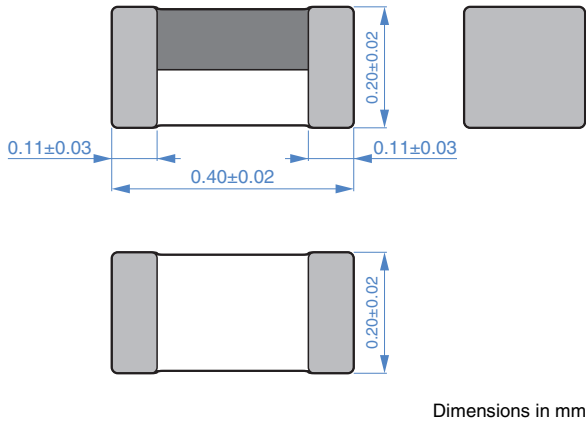

PACKAGING STYLE

REEL DIMENSIONS

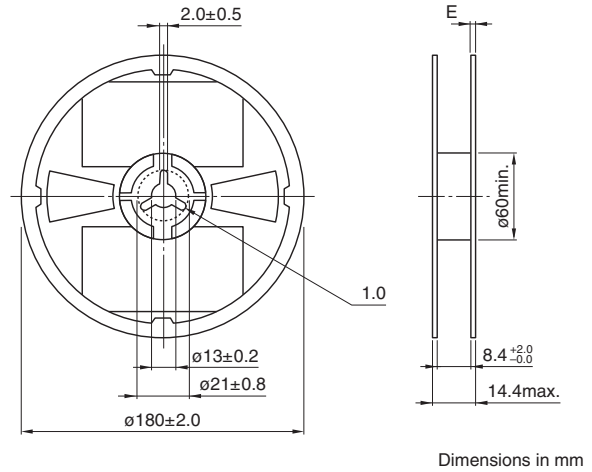

RECOMMENDED LAND PATTERN

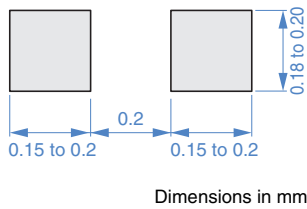

TAPE DIMENSIONS

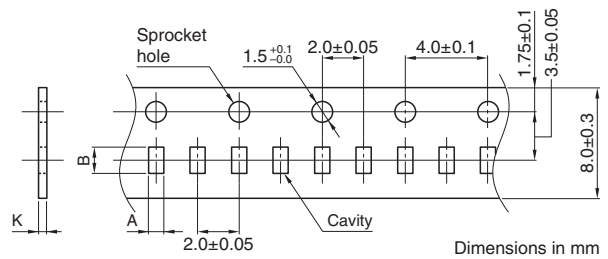

RECOMMENDED REFLOW PROFILE

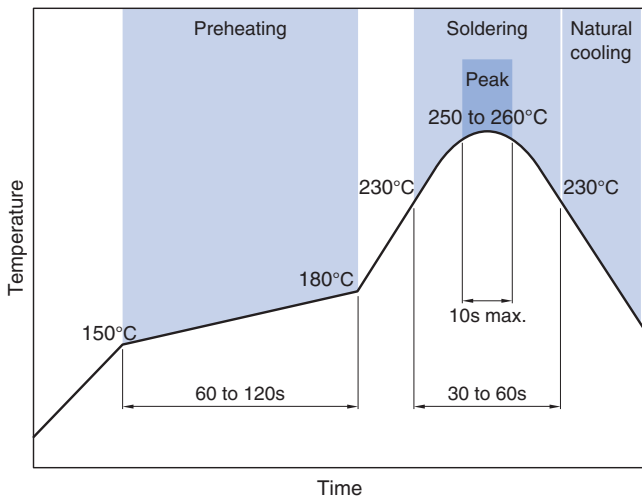

Type	A	B	K
MLG0402Q	0.26±0.04	0.46±0.04	0.4 max.

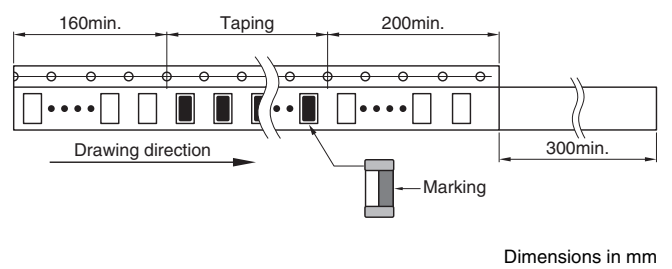

PACKAGE QUANTITY

Package quantity	20000 pcs/reel
------------------	----------------

TEMPERATURE RANGE, INDIVIDUAL WEIGHT

Operating temperature range	Storage temperature range*	Individual weight
-55 to +125 °C	-55 to +125 °C	0.07 mg

* The storage temperature range is for after the assembly.

REMINDERS FOR USING THESE PRODUCTS

Before using these products, be sure to request the delivery specifications.

SAFETY REMINDERS

Please pay sufficient attention to the warnings for safe designing when using this products.

REMINDERS

- The storage period is less than 12 months. Be sure to follow the storage conditions (temperature: 5 to 40°C, humidity: 10 to 75% RH or less).
If the storage period elapses, the soldering of the terminal electrodes may deteriorate.
- Do not use or store in locations where there are conditions such as gas corrosion (salt, acid, alkali, etc.).
- Before soldering, be sure to preheat components.
The preheating temperature should be set so that the temperature difference between the solder temperature and chip temperature does not exceed 150°C.
- Soldering corrections after mounting should be within the range of the conditions determined in the specifications.
If overheated, a short circuit, performance deterioration, or lifespan shortening may occur.
- When embedding a printed circuit board where a chip is mounted to a set, be sure that residual stress is not given to the chip due to the overall distortion of the printed circuit board and partial distortion such as at screw tightening portions.
- Self heating (temperature increase) occurs when the power is turned ON, so the tolerance should be sufficient for the set thermal design.
- Carefully lay out the coil for the circuit board design of the non-magnetic shield type.
A malfunction may occur due to magnetic interference.
- Use a wrist band to discharge static electricity in your body through the grounding wire.
- Do not expose the products to magnets or magnetic fields.
- Do not use for a purpose outside of the contents regulated in the delivery specifications.
- The products listed on this catalog are intended for use in general electronic equipment (AV equipment, telecommunications equipment, home appliances, amusement equipment, computer equipment, personal equipment, office equipment, measurement equipment, industrial robots) under a normal operation and use condition.
The products are not designed or warranted to meet the requirements of the applications listed below, whose performance and/or quality require a more stringent level of safety or reliability, or whose failure, malfunction or trouble could cause serious damage to society, person or property.
If you intend to use the products in the applications listed below or if you have special requirements exceeding the range or conditions set forth in the each catalog, please contact us.



- (1) Aerospace/aviation equipment
- (2) Transportation equipment (cars, electric trains, ships, etc.)
- (3) Medical equipment
- (4) Power-generation control equipment
- (5) Atomic energy-related equipment
- (6) Seabed equipment
- (7) Transportation control equipment

- (8) Public information-processing equipment
- (9) Military equipment
- (10) Electric heating apparatus, burning equipment
- (11) Disaster prevention/crime prevention equipment
- (12) Safety equipment
- (13) Other applications that are not considered general-purpose applications

When designing your equipment even for general-purpose applications, you are kindly requested to take into consideration securing protection circuit/device or providing backup circuits in your equipment.

Looking for pricing, stock, or lifecycle information?

Click below to explore more details on WIN SOURCE:

-  [View MLG0402Q15NHT000 on WIN SOURCE](#)
-  [TDK Corporation](#) Information

Optimize Your Supply Chain with WIN SOURCE Solutions

-  Global Sourcing Solution
-  Obsolete Management
-  Cost Control Management
-  Shortage Management
-  Alternative Solution
-  Excess Inventory Management