



## MIC94040/1/2/3

28mΩ R<sub>DS(on)</sub> 3A High Side Load Switch  
in 1.2mm x 1.2mm MLF<sup>®</sup> package

### General Description

The MIC94040/1/2/3 is a family of high-side load switches designed to operate from 1.7V to 5.5V input voltage. The load switch pass element is an internal 28mΩ R<sub>DS(on)</sub> P-channel MOSFET which enables the device to support up to 3A of continuous current. Additionally, the load switch supports 1.5V logic level control and shutdown features in a tiny 1.2mm x 1.2mm 4 pin MLF<sup>®</sup> package.

The MIC94040 and MIC94041 feature rapid turn on, while the MIC94042 and MIC94043 provide a slew rate controlled soft-start turn-on of 100μs. The soft-start feature is provided to prevent an in-rush current event from pulling down the input supply voltage.

The MIC94041 and MIC94043 feature an active load discharge circuit which switches in a 200Ω load when the switch is disabled to automatically discharge a capacitive load.

An active pull-down on the enable input keeps the MIC94040/1/2/3 in a default OFF state until the enable pin is pulled above 1.2V. Internal level shift circuitry allows low voltage logic signals to switch higher supply voltages. The enable voltage can be as high as 5.5V and is not limited by the input voltage.

The MIC94040/1/2/3 operating voltage range makes them ideal for Lithium ion and NiMH/NiCad/Alkaline battery powered systems, as well as non-battery powered applications. The devices provide low quiescent current and low shutdown current to maximize battery life.

Datasheets and support documentation can be found on Micrel's web site at: [www.micrel.com](http://www.micrel.com).

### Features

- 28mΩ R<sub>DS(on)</sub>
- 3A continuous operating current
- 1.2mm x 1.2mm space saving 4-pin MLF<sup>®</sup> package
- 1.7V to 5.5V input voltage range
- Internal level shift for CMOS/TTL control logic
- Ultra low quiescent current
- Micro-power shutdown current
- Soft-Start: MIC94042, MIC94043
- Load discharge circuit: MIC94041, MIC94043
- Ultra fast turn off time
- Junction operating temperature from -40°C to +125°C

### Applications

- Cellular phones
- Portable Navigation Devices (PND)
- Personal Media Players (PMP)
- Ultra Mobile PCs
- Portable instrumentation
- Other Portable applications
- PDAs
- Industrial and DataComm equipment

### Typical Application

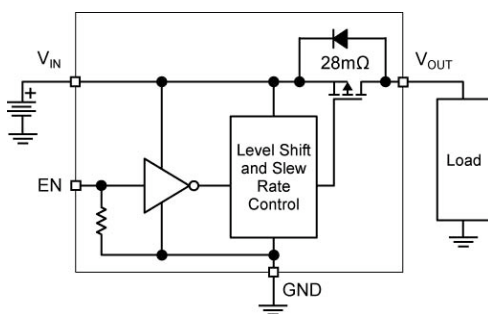

MIC94040 (ultra fast turn on)  
MIC94042 (soft-start)

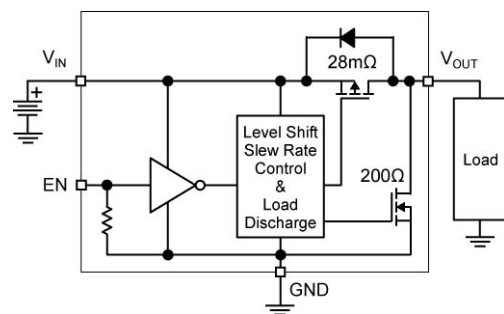

MIC94041 (ultra fast turn on with auto-discharge)  
MIC94043 (soft-start with auto-discharge)

MLF and MicroLeadFrame is a registered trademark of Amkor Technology, Inc.

Micrel Inc. • 2180 Fortune Drive • San Jose, CA 95131 • USA • tel +1 (408) 944-0800 • fax +1 (408) 474-1000 • <http://www.micrel.com>

## Ordering Information

Part Number	Part Marking <sup>(1)</sup>	Fast Turn On	Soft-Start	Load Discharge	Package <sup>(2)</sup>
MIC94040YFL	— P4	•			4-Pin (1.2mm x 1.2mm) MLF <sup>®</sup>
MIC94041YFL	— P1	•		•	4-Pin (1.2mm x 1.2mm) MLF <sup>®</sup>
MIC94042YFL	— P2		•		4-Pin (1.2mm x 1.2mm) MLF <sup>®</sup>
MIC94043YFL	— P3		•	•	4-Pin (1.2mm x 1.2mm) MLF <sup>®</sup>

### Notes:

1. MLF<sup>®</sup> Pin 1 Identifier symbol is “•”.
2. MLF<sup>®</sup> is a GREEN RoHS-compliant package. Lead finish is NiPdAu. Mold compound is Halogen Free.

## Pin Configuration

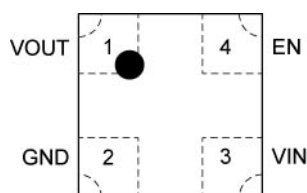

Top View

4-Pin (1.2mm x 1.2mm) MLF<sup>®</sup>

## Pin Description

Pin Number	Pin Name	Pin Function
1	V <sub>OUT</sub>	Drain of P-channel MOSFET.
2	GND	Ground should be connected to electrical ground.
3	V <sub>IN</sub>	Source of P-channel MOSFET.
4	EN	Enable (Input): Active-high CMOS/TTL control input for switch. Internal ~2MΩ Pull down resistor. Output will be off if this pin is left floating.

### Absolute Maximum Ratings<sup>(1)</sup>

Input Voltage ( $V_{IN}$ )	.....+6V
Enable Voltage ( $V_{EN}$ )	.....+6V
Continuous Drain Current ( $I_D$ ) <sup>(3)</sup>	
$T_A = 25^\circ\text{C}$	..... $\pm 3\text{A}$
$T_A = 85^\circ\text{C}$	..... $\pm 2\text{A}$
Pulsed Drain Current ( $I_{DP}$ ) <sup>(4)</sup>	..... $\pm 6.0\text{A}$
Continuous Diode Current ( $I_S$ ) <sup>(5)</sup>	..... $-50\text{mA}$
Storage Temperature ( $T_S$ )	..... $-55^\circ\text{C}$ to $+150^\circ\text{C}$
ESD Rating – HBM <sup>(6)</sup>	..... $3\text{kV}$

### Operating Ratings<sup>(2)</sup>

Input Voltage ( $V_{IN}$ )	.....+1.7 to +5.5V
Junction Temperature ( $T_J$ )	..... $-40^\circ\text{C}$ to $+125^\circ\text{C}$
Package Thermal Resistance	
MLF <sup>®</sup> ( $\theta_{JC}$ )	..... $90^\circ\text{C/W}$

### Electrical Characteristics

$T_A = 25^\circ\text{C}$ , bold values indicate  $-40^\circ\text{C} \leq T_A \leq +85^\circ\text{C}$ , unless noted.

Symbol	Parameter	Condition	Min	Typ	Max	Units
$V_{EN\_TH}$	Enable Threshold Voltage	$V_{IN} = 1.7\text{V}$ to $4.5\text{V}$ , $I_D = -250\mu\text{A}$	<b>0.4</b>		<b>1.2</b>	V
$I_Q$	Quiescent Current	$V_{IN} = V_{EN} = 5.5\text{V}$ , $I_D = \text{OPEN}$ Measured on $V_{IN}$ MIC94040, MIC94041		0.1	1	$\mu\text{A}$
		$V_{IN} = V_{EN} = 5.5\text{V}$ , $I_D = \text{OPEN}$ Measured on $V_{IN}$ MIC94042, MIC94043		7	10	
$I_{EN}$	Enable Input Current	$V_{IN} = V_{EN} = 5.5\text{V}$ , $I_D = \text{OPEN}$		2.5	4	$\mu\text{A}$
$I_{SHUT-Q}$	Quiescent Current (shutdown)	$V_{IN} = +5.5\text{V}$ , $V_{EN} = 0\text{V}$ , $I_D = \text{OPEN}$ Measured on $V_{IN}$		0.1	1	$\mu\text{A}$
$I_{SHUT-SWITCH}$	OFF State Leakage Current	$V_{IN} = +5.5\text{V}$ , $V_{EN} = 0\text{V}$ , $I_D = \text{SHORT}$ Measured on $V_{OUT}$ , <sup>(7)</sup>		0.1	1	$\mu\text{A}$
$R_{DS(ON)}$	P-Channel Drain to Source ON Resistance	$V_{IN} = +5.0\text{V}$ , $I_D = -100\text{mA}$ , $V_{EN} = 1.5\text{V}$		28	<b>55</b>	$\text{m}\Omega$
		$V_{IN} = +4.5\text{V}$ , $I_D = -100\text{mA}$ , $V_{EN} = 1.5\text{V}$		30	<b>60</b>	$\text{m}\Omega$
		$V_{IN} = +3.6\text{V}$ , $I_D = -100\text{mA}$ , $V_{EN} = 1.5\text{V}$		33	<b>65</b>	$\text{m}\Omega$
		$V_{IN} = +2.5\text{V}$ , $I_D = -100\text{mA}$ , $V_{EN} = 1.5\text{V}$		45	<b>90</b>	$\text{m}\Omega$
		$V_{IN} = +1.8\text{V}$ , $I_D = -100\text{mA}$ , $V_{EN} = 1.5\text{V}$		72	<b>145</b>	$\text{m}\Omega$
		$V_{IN} = +1.7\text{V}$ , $I_D = -100\text{mA}$ , $V_{EN} = 1.5\text{V}$		82	<b>160</b>	$\text{m}\Omega$
$R_{SHUTDOWN}$	Turn-Off Resistance (MIC94041, MIC94043)	$V_{IN} = +3.6\text{V}$ , $I_{TEST} = 1\text{mA}$ , $V_{EN} = 0\text{V}$		250	<b>400</b>	$\Omega$

**Notes:**

1. Exceeding the absolute maximum rating may damage the device.
2. The device is not guaranteed to function outside its operating rating.
3. With thermal contact to PCB. See thermal considerations section.
4. Pulse width  $< 300\mu\text{s}$  with  $< 2\%$  duty cycle.
5. Continuous body diode current conduction (reverse conduction, i.e.  $V_{OUT}$  to  $V_{IN}$ ) is not recommended.
6. Devices are ESD sensitive. Handling precautions recommended. HBM (Human body model),  $1.5\text{k}\Omega$  in series with  $100\text{pF}$ .
7. Measured on the MIC94040YFL and MIC94042YFL.

## Electrical Characteristics (Dynamic)

$T_A = 25^\circ\text{C}$ , bold values indicate  $-40^\circ\text{C} \leq T_A \leq +85^\circ\text{C}$ , unless noted.

Symbol	Parameter	Condition	Min	Typ	Max	Units
$t_{\text{ON\_DLY}}$	Turn-On Delay Time	$V_{\text{IN}} = +3.6\text{V}$ , $I_{\text{D}} = -100\text{mA}$ , $V_{\text{EN}} = 1.5\text{V}$ MIC94040, MIC94041		0.97	1.5	$\mu\text{s}$
		$V_{\text{IN}} = +3.6\text{V}$ , $I_{\text{D}} = -100\text{mA}$ , $V_{\text{EN}} = 1.5\text{V}$ MIC94042, MIC94043	50	106	185	$\mu\text{s}$
$t_{\text{ON\_RISE}}$	Turn-On Rise Time	$V_{\text{IN}} = +3.6\text{V}$ , $I_{\text{D}} = -100\text{mA}$ , $V_{\text{EN}} = 1.5\text{V}$ MIC94040, MIC94041	0.5	0.9	5	$\mu\text{s}$
		$V_{\text{IN}} = +3.6\text{V}$ , $I_{\text{D}} = -100\text{mA}$ , $V_{\text{EN}} = 1.5\text{V}$ MIC94042, MIC94043	50	116	200	$\mu\text{s}$
$t_{\text{OFF\_DLY}}$	Turn-Off Delay Time	$V_{\text{IN}} = +3.6\text{V}$ , $I_{\text{D}} = -100\text{mA}$ , $V_{\text{EN}} = 0\text{V}$		100	200	ns
$t_{\text{OFF\_FALL}}$	Turn-Off Fall Time	$V_{\text{IN}} = +3.6\text{V}$ , $I_{\text{D}} = -100\text{mA}$ , $V_{\text{EN}} = 0\text{V}$		20	100	ns

# Typical Characteristics

**MIC94040/1/2/3**

**$R_{DS(on)}$  Variance vs. Temperature**

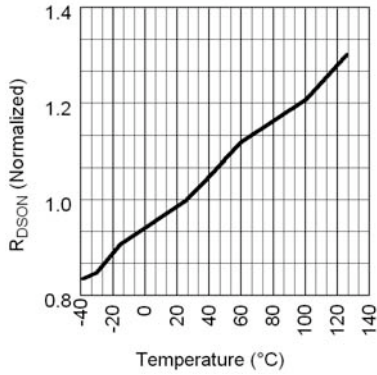

**MIC94040/1/2/3**

**Voltage Drop vs. Load Current**

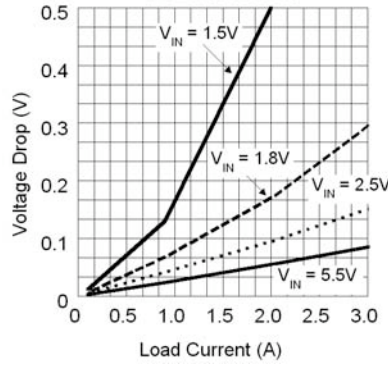

**MIC94040/1/2/3**

**On Resistance vs. Input Voltage**

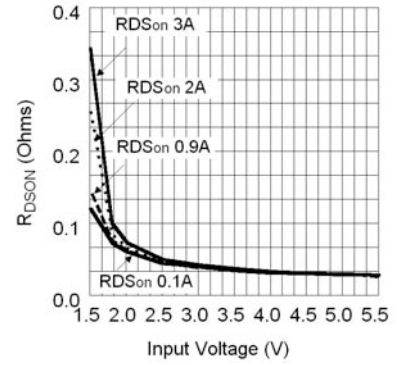

**MIC94040/1**

**Enable Threshold vs. Input Voltage**

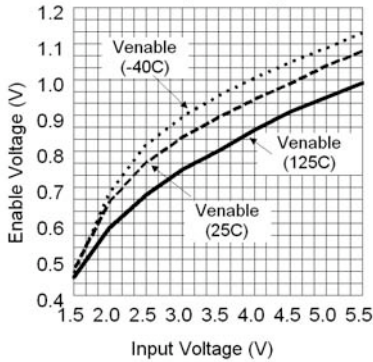

**MIC94042/3**

**Enable Threshold vs. Input Voltage**

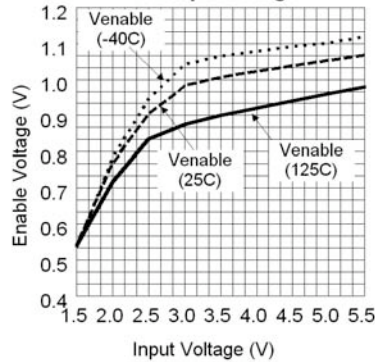

**MIC94040/41**

**Quiescent Current vs. Temperature**

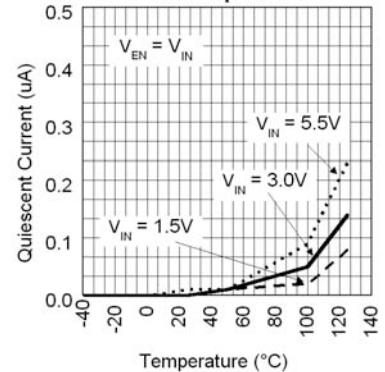

**MIC94042/3**

**Quiescent Current vs. Temperature**

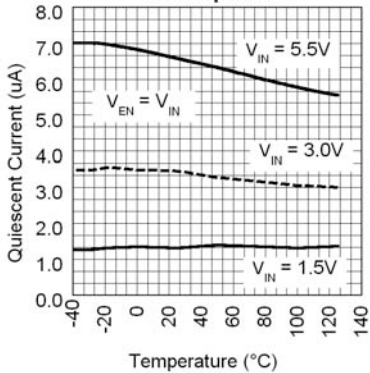

**MIC94042/3**

**Enable Current vs. Temperature**

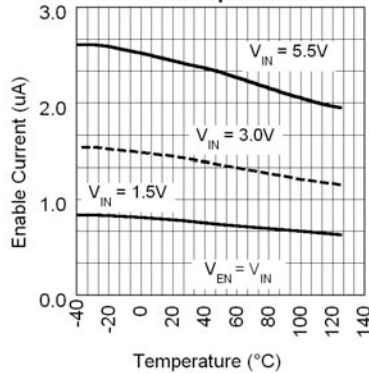

**MIC94040/1**

**T\_ON Delay vs. Input Voltage**

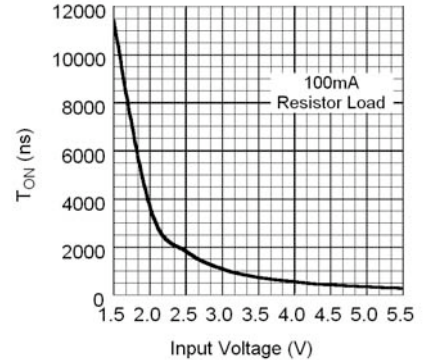

# Typical Characteristics

**MIC94042/3**

**$T_{ON}$  Delay vs. Input Voltage**

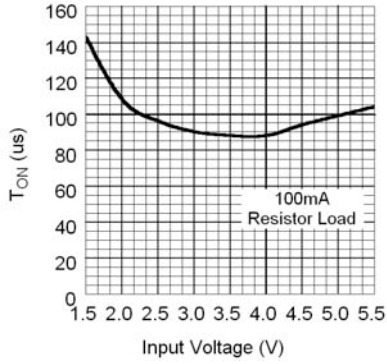

**MIC94040/1**

**Rise Time vs. Input Voltage**

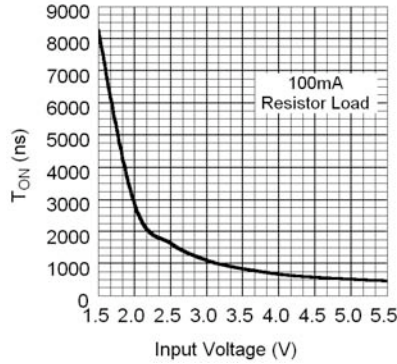

**MIC94042/3**

**Rise Time vs. Input Voltage**

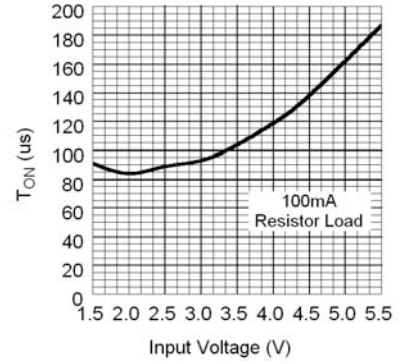

**MIC94040/1**

**Turn on Rise Time vs. Temperature**

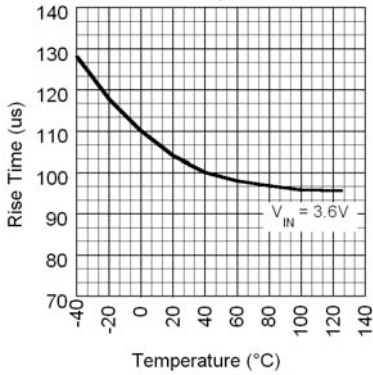

**MIC94042/3**

**$T_{OFF}$  Delay vs. Input Voltage**

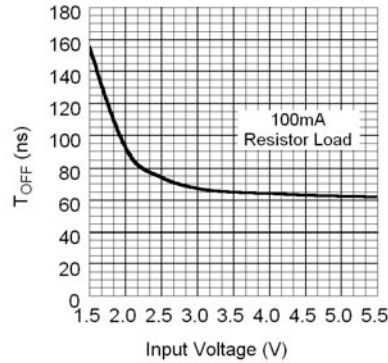

**MIC94040/1/2/3**

**$T_{OFF}$  Delay vs. Input Voltage**

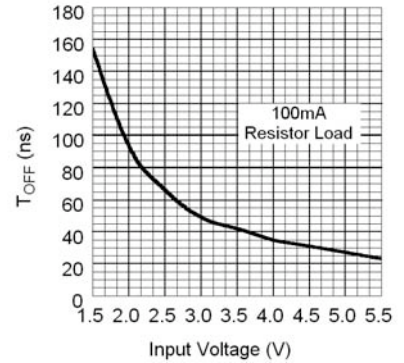

**MIC94042/3**

**Fall Time vs. Input Voltage**

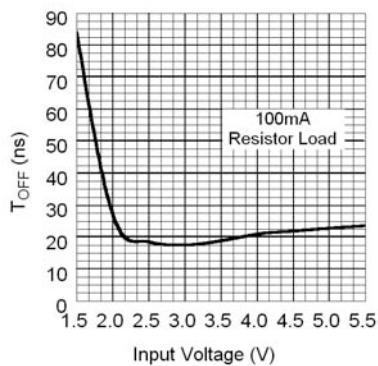

# Functional Characteristics

## MIC94040

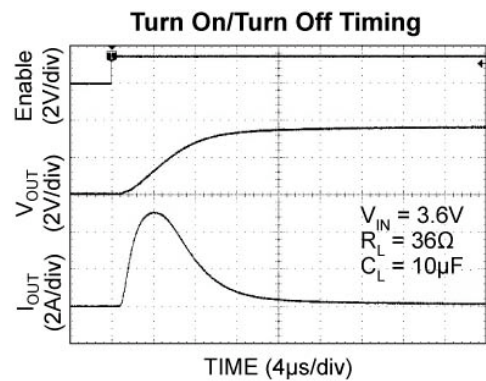
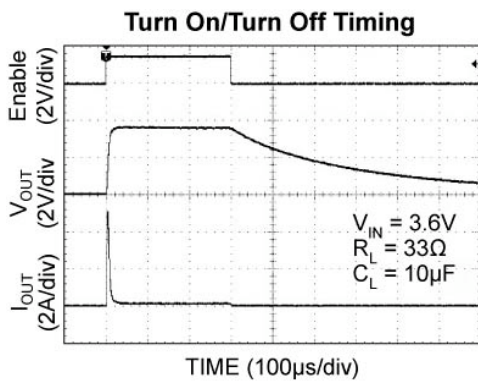
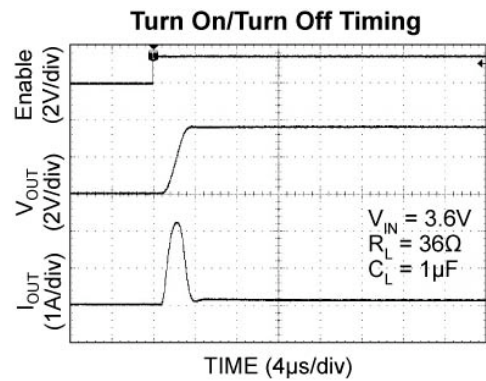
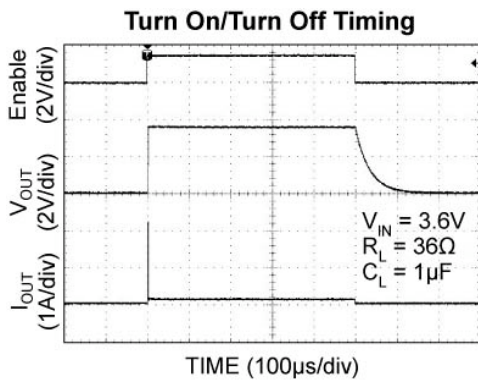
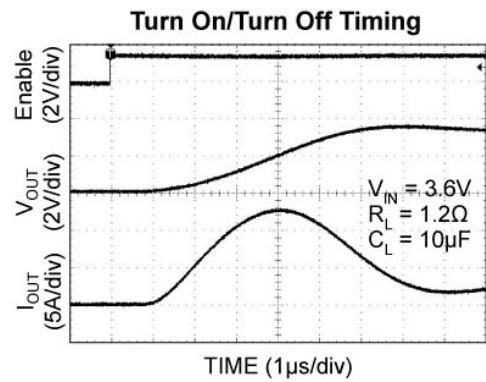
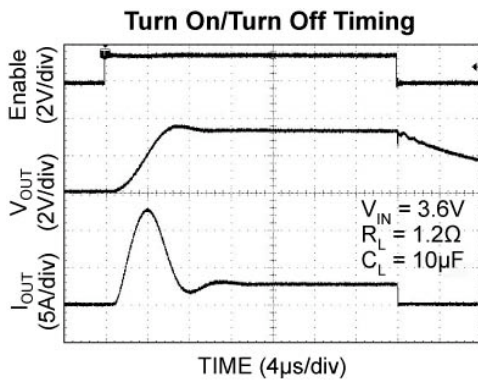
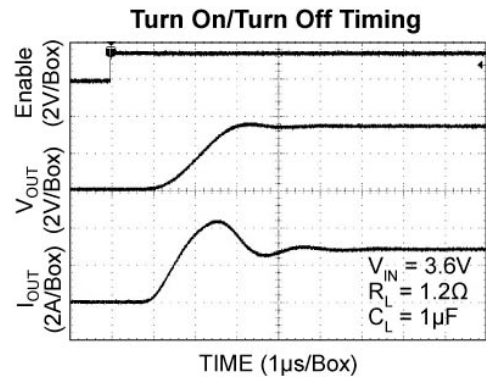
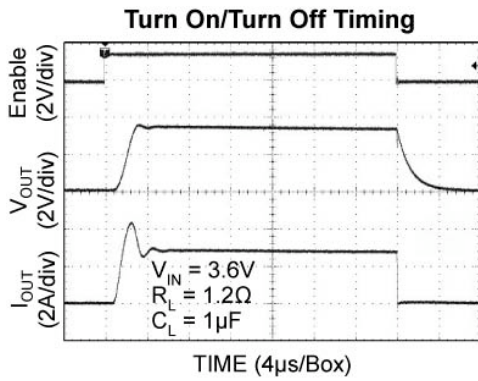

MIC94041

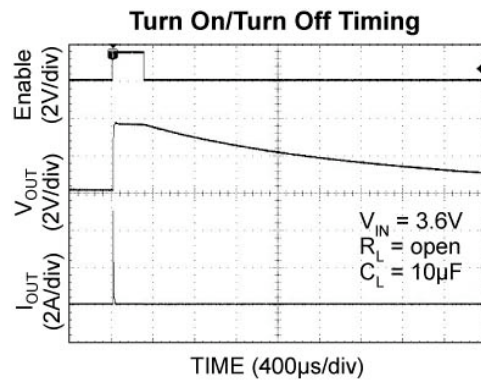
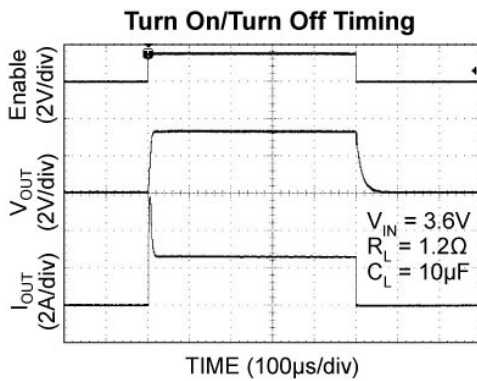
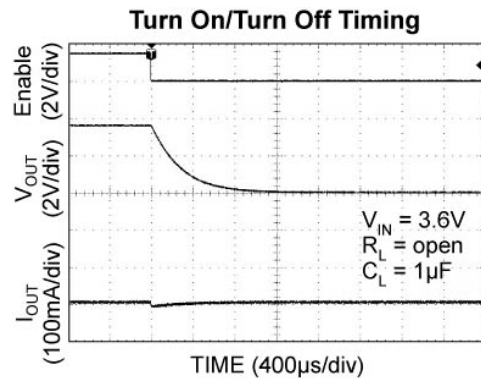
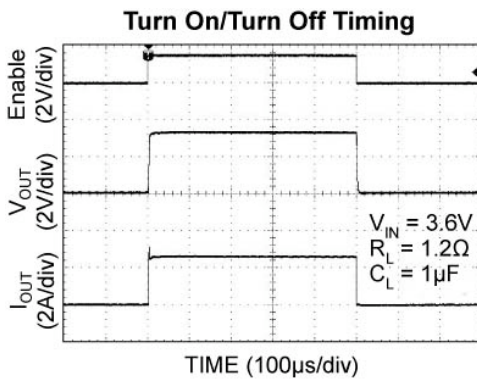
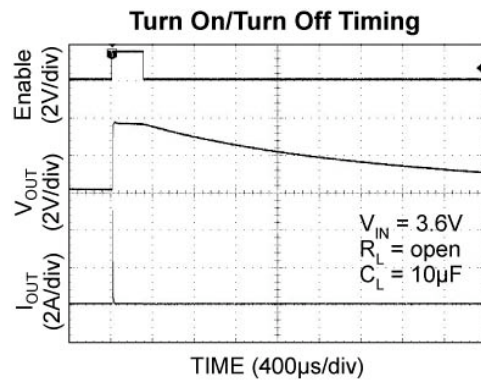
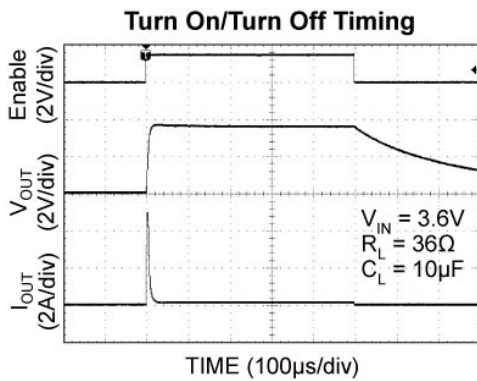
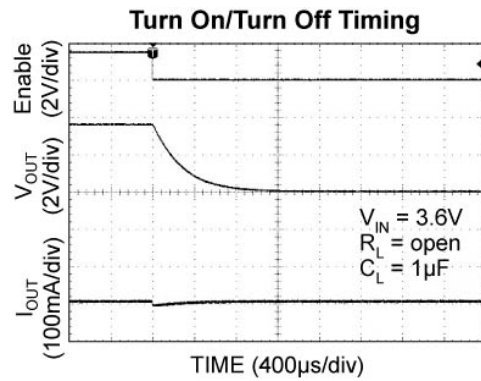
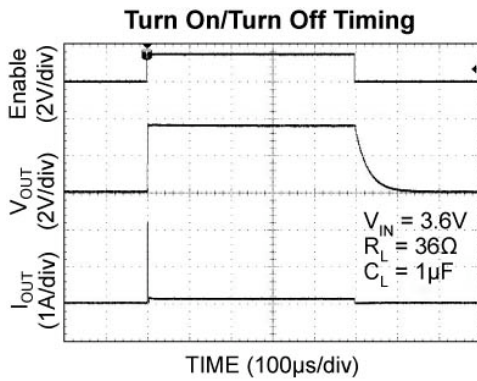

### MIC94042

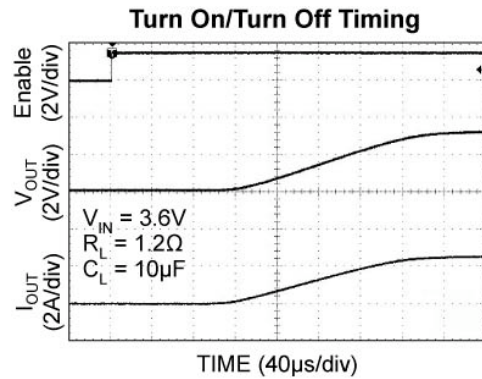
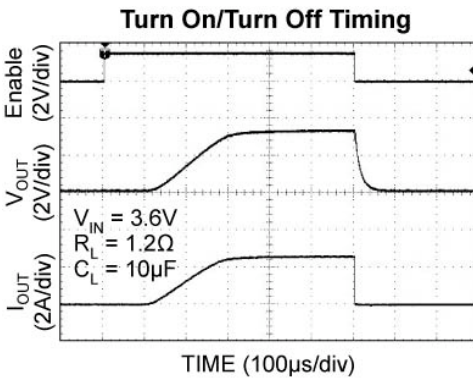
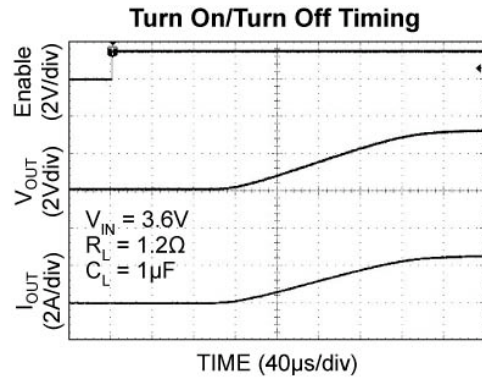
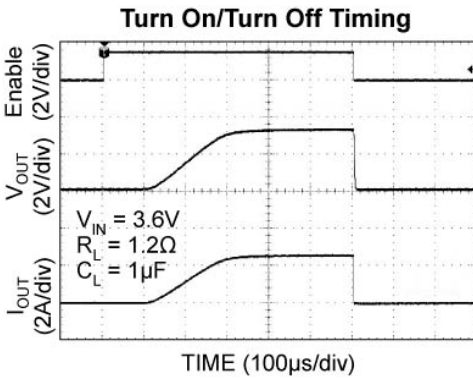
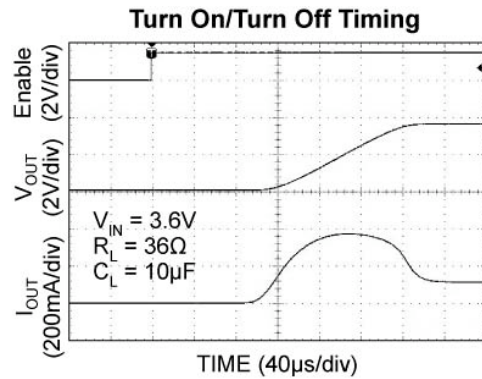
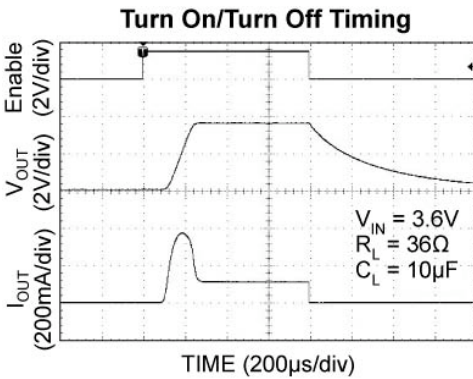
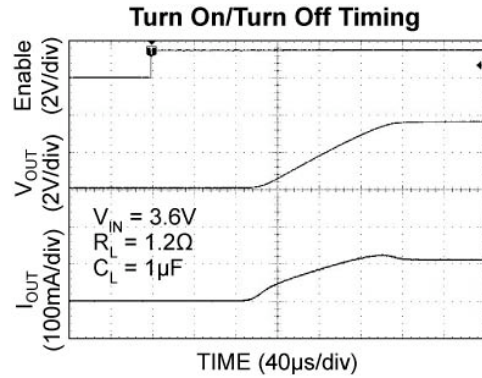
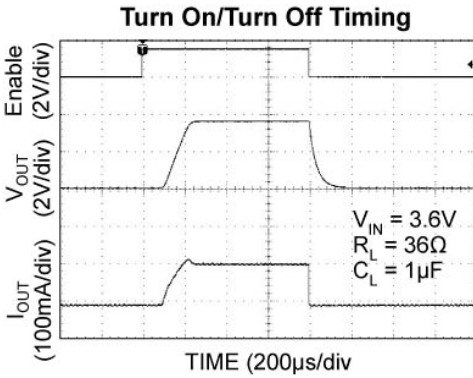

### MIC94043

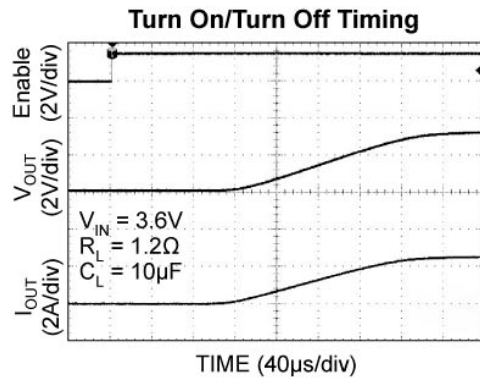
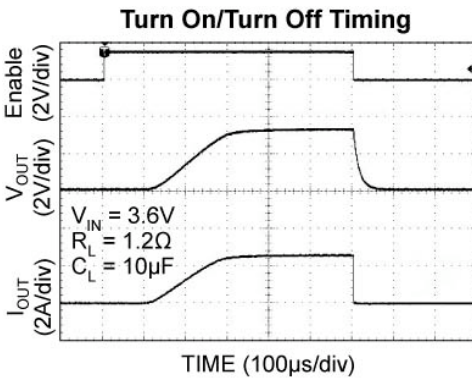
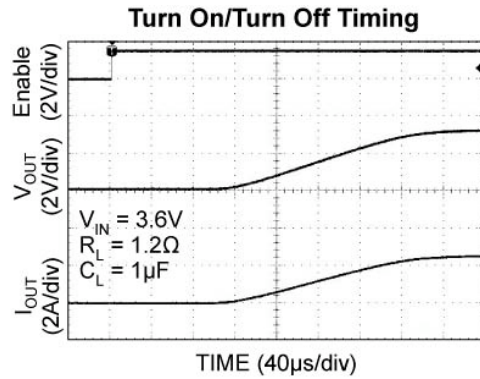
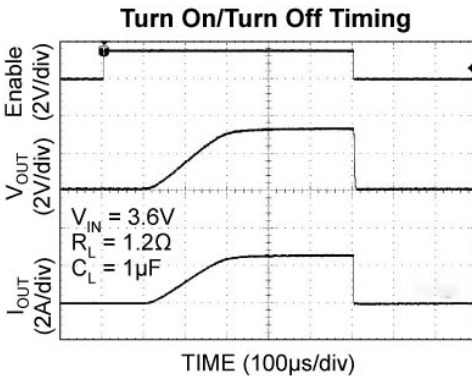
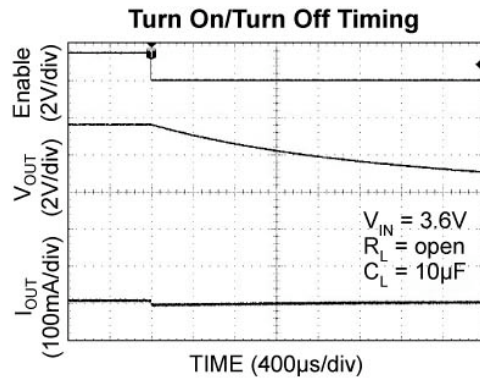
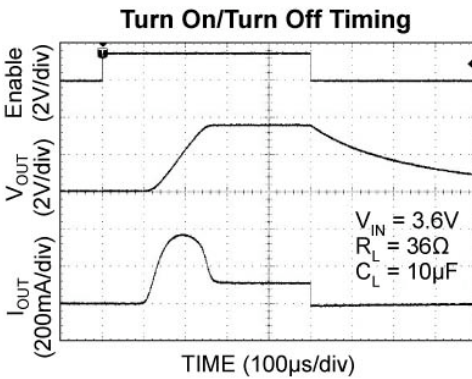
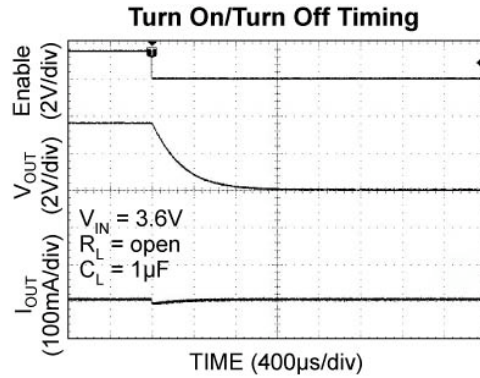
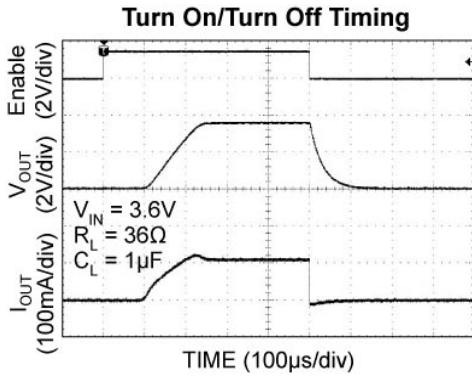

## Application Information

### Power Dissipation Considerations

As with all power switches, the current rating of the switch is limited mostly by the thermal properties of the package and the PCB it is mounted on. There is a simple ohms law type relationship between thermal resistance, power dissipation and temperature, which are analogous to an electrical circuit:

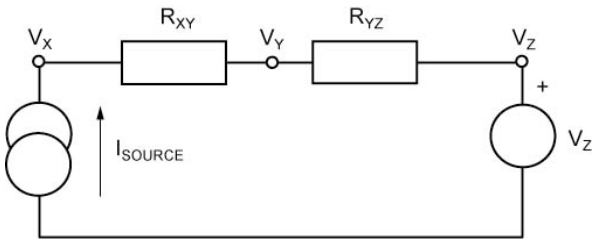

Figure 1. Simple Electrical Circuit

From this simple circuit we can calculate  $V_x$  if we know  $I_{source}$ ,  $V_z$  and the resistor values,  $R_{xy}$  and  $R_{yz}$  using the equation:

$$V_x = I_{source} \cdot (R_{xy} + R_{yz}) + V_z$$

Thermal circuits can be considered using these same rules and can be drawn similarly by replacing current sources with power dissipation (in Watts), resistance with thermal resistance (in  $^{\circ}C/W$ ) and voltage sources with temperature (in  $^{\circ}C$ ).

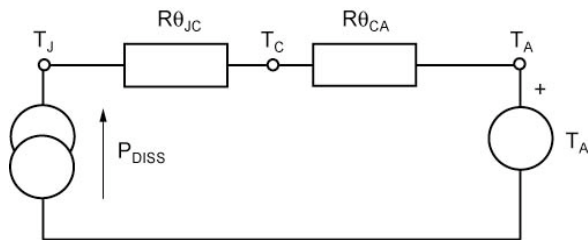

Figure 2. Simple Thermal Circuit

Now replacing the variables in the equation for  $V_x$ , we can find the junction temperature ( $T_j$ ) from power dissipation, ambient temperature and the known thermal resistance of the PCB ( $R_{\theta_{CA}}$ ) and the package ( $R_{\theta_{JC}}$ ).

$$T_j = P_{DISS} \times (R_{\theta_{JC}} + R_{\theta_{CA}}) + T_A$$

$P_{DISS}$  is calculated as  $I_{SWITCH}^2 \times R_{SWmax}$ .  $R_{\theta_{JC}}$  is found in the operating ratings section of the datasheet and  $R_{\theta_{CA}}$  (the PCB thermal resistance) values for various PCB copper areas is discussed in the document "Designing with Low Dropout Voltage Regulators" available from the Micrel website (LDO Application Hints).

### Example:

A switch is intended to drive a 2A load and is placed on a printed circuit board which has a ground plane area of at least 25mm by 25mm ( $625mm^2$ ). The Voltage source is a Li-ion battery with a lower operating threshold of 3V and the ambient temperature of the assembly can be up to  $50^{\circ}C$ .

Summary of variables:

$$I_{SW} = 2A$$

$$V_{IN} = 3V \text{ to } 4.2V$$

$$T_A = 50^{\circ}C$$

$$R_{\theta_{JC}} = 90^{\circ}C/W \text{ from Datasheet}$$

$$R_{\theta_{CA}} = 53^{\circ}C/W \text{ Read from Graph in Figure 3}$$

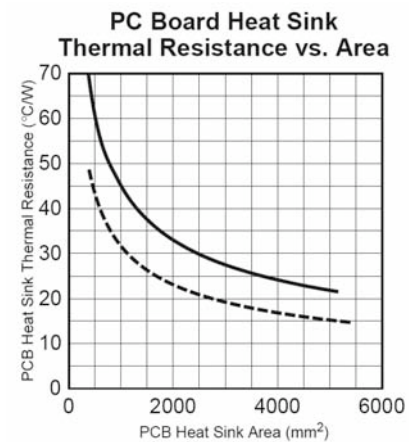

Figure 3. Excerpt from the LDO Book

$$P_{DISS} = I_{SW}^2 \times R_{SWmax}$$

The worst case switch resistance ( $R_{SWmax}$ ) at the lowest  $V_{IN}$  of 3V is not available in the datasheet, so the next lower value of  $V_{IN}$  is used.

$$R_{SWmax} @ 2.5v = 90m\Omega$$

If this were a figure for worst case  $R_{SWmax}$  for  $25^{\circ}C$ , an additional consideration is to allow for the maximum junction temperature of  $125^{\circ}C$ , the actual worst case resistance in this case can be 30% higher (See  $R_{DS(on)}$  variance vs. temperature graph). However,  $90m\Omega$  is the maximum over temperature.

Therefore:

$$T_j = 2^2 \times 0.090 \times (90+53) + 50$$

$$T_j = 101^{\circ}C$$

This is below the maximum  $125^{\circ}C$ .

## Package Information

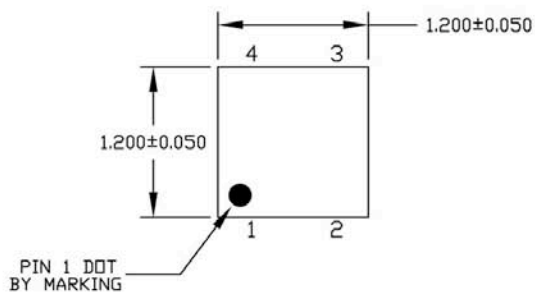

TOP VIEW

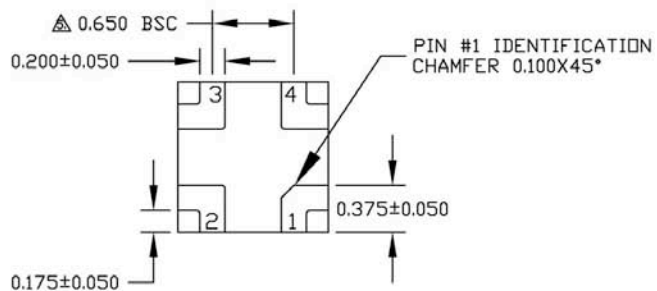

BOTTOM VIEW

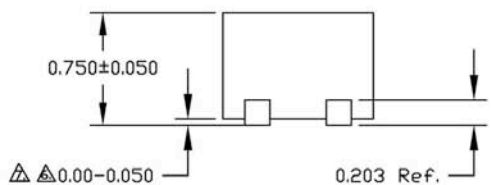

SIDE VIEW

**NOTE:**

1. ALL DIMENSIONS ARE IN MILLIMETERS.
  2. MAX. PACKAGE WARPAGE IS 0.05 mm.
  3. MAXIMUM ALLOWABLE BURRS IS 0.076 mm IN ALL DIRECTIONS.
  4. PIN #1 ID ON TOP WILL BE LASER/INK MARKED.
- DIMENSION APPLIES TO METALIZED TERMINAL AND IS MEASURED BETWEEN 0.20 AND 0.25 mm FROM TERMINAL TIP.  
 APPLIED ONLY FOR TERMINALS.  
 APPLIED FOR EXPOSED PAD AND TERMINALS.

**4-Pin (1.2mm x 1.2mm) MLF<sup>®</sup>**

All units are in mm  
Tolerance  $\pm 0.05$  if not noted

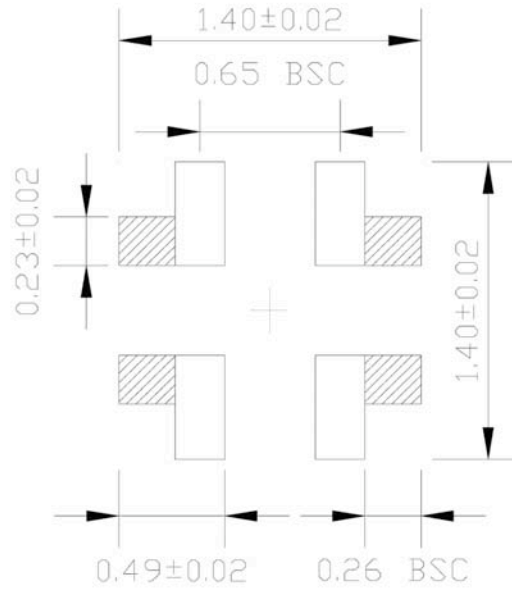

 Optional (For Thermal Improvement)

Disclaimer: This is only a recommendation based on information available to Micrel from its suppliers. Actual land pattern may have to be significantly different due to various materials and processes used in PCB assembly. Micrel makes no representation or warranty of performance based on the recommended land pattern."

**Suggested Landing Pattern for 4 Pin (1.2mm x 1.2mm) MLF<sup>®</sup>**

**MICREL, INC. 2180 FORTUNE DRIVE SAN JOSE, CA 95131 USA**  
TEL +1 (408) 944-0800 FAX +1 (408) 474-1000 WEB <http://www.micrel.com>

The information furnished by Micrel in this data sheet is believed to be accurate and reliable. However, no responsibility is assumed by Micrel for its use. Micrel reserves the right to change circuitry and specifications at any time without notification to the customer.

Micrel Products are not designed or authorized for use as components in life support appliances, devices or systems where malfunction of a product can reasonably be expected to result in personal injury. Life support devices or systems are devices or systems that (a) are intended for surgical implant into the body or (b) support or sustain life, and whose failure to perform can be reasonably expected to result in a significant injury to the user. A Purchaser's use or sale of Micrel Products for use in life support appliances, devices or systems is a Purchaser's own risk and Purchaser agrees to fully indemnify Micrel for any damages resulting from such use or sale.

© 2008 Micrel, Incorporated.

## Looking for pricing, stock, or lifecycle information?

Click below to explore more details on WIN SOURCE:

- ⊖ [View MIC94043YFL-TR on WIN SOURCE](#)
- ⊖ [Microchip Technology](#) Information

## Optimize Your Supply Chain with WIN SOURCE Solutions

- ✓ Global Sourcing Solution
- ✓ Obsolete Management
- ✓ Cost Control Management
- ✓ Shortage Management
- ✓ Alternative Solution
- ✓ Excess Inventory Management