



MIC861

Teeny™ Ultra-Low-Power Op Amp

General Description

The MIC861 is a rail-to-rail output, input common-mode to ground, operational amplifier in Teeny™ SC70 packaging. The MIC861 provides a 400kHz gain-bandwidth product while consuming an incredibly low 4.6µA supply current.

The SC70 packaging achieves significant board space savings over devices packaged in SOT-23 or MSOP-8 packaging. The SC70 occupies approximately half the board area of a SOT-23 package.

Datasheets and support documentation are available on Micrel's website at: www.micrel.com.

Features

- Teeny™ SC70 packaging
- 400kHz gain-bandwidth product
- 650kHz, -3dB bandwidth
- 4.6µA supply current
- Rail-to-rail output
- Ground sensing at input (common mode to GND)
- Drives large capacitive loads (1000pF)
- Unity gain stable

Applications

- Portable equipment
- PDAs
- Pagers
- Cordless phones
- Consumer electronics

Functional Pinout

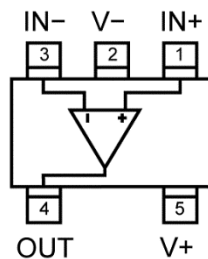

Teeny is a trademark of Micrel, Inc.

Micrel Inc. • 2180 Fortune Drive • San Jose, CA 95131 • USA • tel +1 (408) 944-0800 • fax + 1 (408) 474-1000 • <http://www.micrel.com>

Ordering Information

Part Number	Marking ⁽¹⁾	Ambient Temperature Range	Package
MIC861YC5	<u>A33</u>	-40° to +85°C	5-Pin SC70

Note:

- Underbar marking may not be to scale.

Pin Configuration

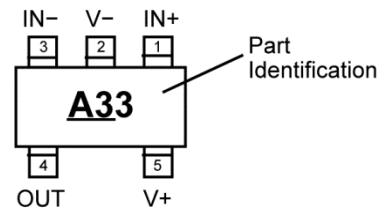

5-Pin SC70 (C5)
(Top View)

Pin Description

Pin Number	Pin Name	Pin Function
1	IN+	Non-inverting input.
2	V-	Negative power supply connection. Connect a 10 μ F and 0.1 μ F capacitor in parallel to this pin for power supply bypassing.
3	IN-	Inverting input.
4	OUT	Output of operational amplifier.
5	V+	Positive power supply input. Connect a 10 μ F and 0.1 μ F capacitor in parallel to this pin for power supply bypassing.

Absolute Maximum Ratings⁽²⁾

Supply Voltage ($V_{V+} - V_{V-}$).....	+6.0V
Differential Input Voltage $ V_{IN+} - V_{IN-} $	+6.0V
Input Voltage ($V_{IN+} - V_{IN-}$).....	$V_+ + 0.3V, V_- - 0.3V$
Lead Temperature (soldering, 5s).....	260°C
Output Short Circuit Current Duration.....	Indefinite
Storage Temperature (T_s).....	150°C
ESD Rating.....	Note 4

Operating Ratings⁽³⁾

Supply Voltage ($V_{V+} - V_{V-}$)	+2.43V to +5.25V
Ambient Temperature (T_A)	-40°C to +85°C
Junction Thermal Resistance	
5-Pin SC70 (Θ_{JA})	450°C/W

Electrical Characteristics⁽⁵⁾

$V_+ = +2.7V, V_- = 0V, V_{CM} = V_+/2; R_L = 500k\Omega$ to $V_+/2; T_A = 25^\circ C$, **bold** values indicate $-40^\circ C \leq T_A \leq +85^\circ C$, unless noted.

Symbol	Parameter	Condition	Min.	Typ.	Max.	Units
V_{OS}	Input Offset Voltage	Note 6	-10	2	10	mV
	Input Offset Voltage Temperature Coefficient			15		$\mu V/^\circ C$
I_B	Input Bias Current			20		pA
I_{OS}	Input Offset Current			10		pA
V_{CM}	Input Voltage Range	CMRR >60dB		1.8		V
CMRR	Common Mode Rejection Ratio	$0 < V_{CM} < 1.35V$	45	77		dB
PSRR	Power Supply Rejection Ratio	Supply voltage change of 3V	50	83		dB
A_{VOL}	Large Signal Voltage Gain	$R_L = 100k\Omega, V_{OUT} = 2V$ peak-to-peak	60	74		dB
		$R_L = 500k\Omega, V_{OUT} = 2V$ peak-to-peak	73	83		dB
V_{OUT}	Maximum Output Voltage Swing	$R_L = 500k\Omega$	V $\pm 2mV$	$\frac{V}{\pm 0.7mV}$		V
V_{OUT}	Minimum Output Voltage Swing	$R_L = 500k\Omega$		$\frac{V}{\pm 0.2mV}$	V $\pm 2mV$	V
GBW	Gain-Bandwidth Product	$R_L = 200k\Omega, C_L = 2pF, V_{OUT} = 0$		350		kHz
BW	-3dB Bandwidth	$A_V = 1, C_L = 2pF, R_L = 1M\Omega$		500		kHz
SR	Slew Rate	$A_V = 1, C_L = 2pF, R_L = 1M\Omega$		0.12		V/ μs
I_{SC}	Short-Circuit Output Current	Source		6		mA
		Sink		5		mA
I_S	Supply Current	No load		4.2	9	μA

Notes:

- Exceeding the absolute maximum ratings may damage the device.
- The device is not guaranteed to function outside its operating ratings.
- Devices are ESD sensitive. Handling precautions are recommended. Human body model, 1.5k Ω in series with 100pF. Pin 4 is ESD sensitive.
- Specification for packaged product only. Exceeding the maximum differential input voltage will damage the input stage and degrade performance (in particular, input bias will likely increase).
- The offset voltage distribution is centered around 0V. The typical offset number shown is equal to the standard deviation of the voltage offset distribution.

Electrical Characteristics⁽⁵⁾ (Continued)

V₊ = +5V, V₋ = 0V, V_{CM} = V₊/2; R_L = 500kΩ to V₊/2; T_A = 25°C, **bold** values indicate -40°C ≤ T_A ≤ +85°C, unless noted.

Symbol	Parameter	Condition	Min.	Typ.	Max.	Units
V _{OS}	Input Offset Voltage	Note 6	-10	2	10	mV
	Input Offset Voltage Temperature Coefficient			15		μV/°C
I _B	Input Bias Current			20		pA
I _{OS}	Input Offset Current			10		pA
V _{CM}	Input Voltage Range	CMRR >60dB		4.2		V
CMRR	Common Mode Rejection Ratio	0 < V _{CM} < 3.5V	60	80		dB
PSRR	Power Supply Rejection Ratio	Supply voltage change of 1V	45	85		dB
A _{VOL}	Large Signal Voltage Gain	R _L = 100kΩ, V _{OUT} = 4V peak-to-peak	60	76		dB
		R _L = 500kΩ, V _{OUT} = 4V peak-to-peak	68	83		dB
V _{OUT}	Maximum Output Voltage Swing	R _L = 500kΩ	V ±2mV	$\frac{V}{\pm 0.7mV}$		V
V _{OUT}	Minimum Output Voltage Swing	R _L = 500kΩ		$\frac{V}{\pm 0.7mV}$	V ±2mV	V
GBW	Gain-Bandwidth Product	R _L = 200kΩ, C _L = 2pF, V _{OUT} = 0		400		kHz
BW	-3dB Bandwidth	A _V = 1, C _L = 2pF, R _L = 1MΩ		650		kHz
SR	Slew Rate	A _V = 1, C _L = 2pF, R _L = 1MΩ		0.12		V/μs
I _{SC}	Short-Circuit Output Current	Source	10	24		mA
		Sink	10	24		mA
I _S	Supply Current	No load		4.6	9	μA

Test Circuits

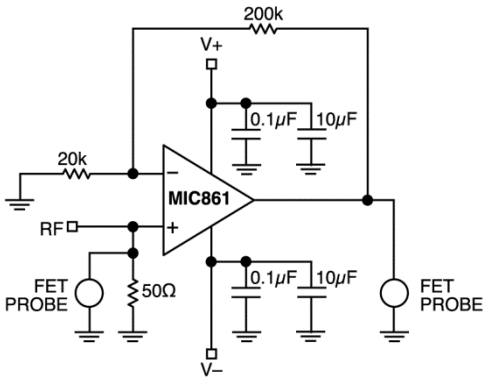

Test Circuit 1. $A_v = 11$

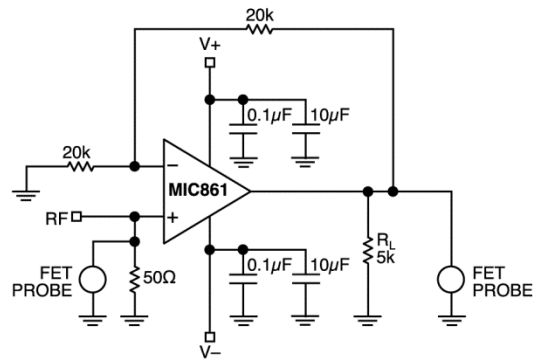

Test Circuit 2. $A_v = 2$

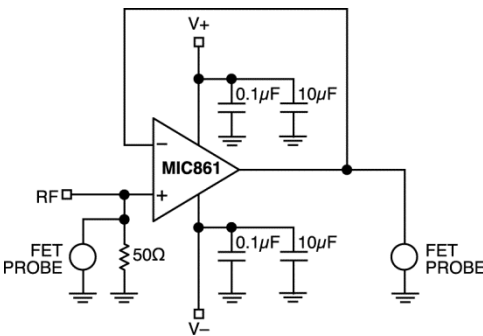

Test Circuit 3. $A_v = 1$

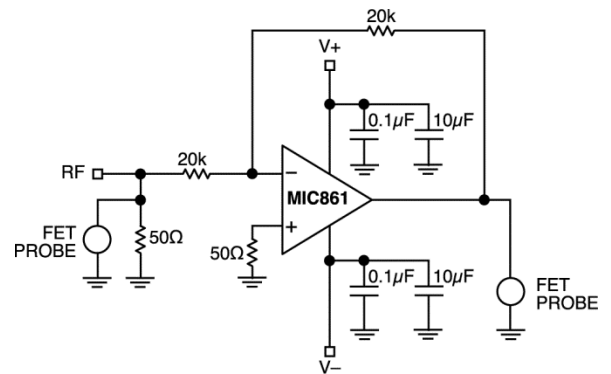

Test Circuit 4. $A_v = -1$

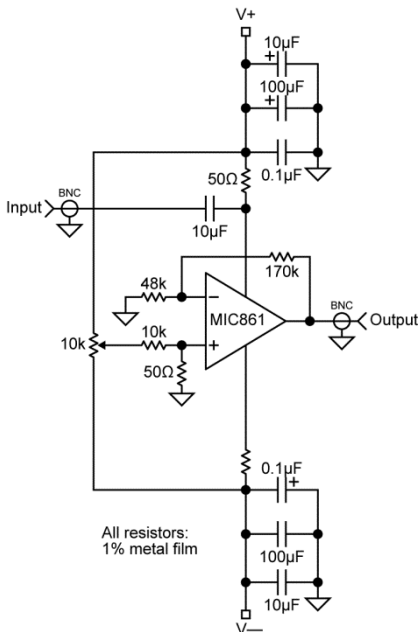

Test Circuit 5. Positive Power Supply Rejection Ratio Measurement

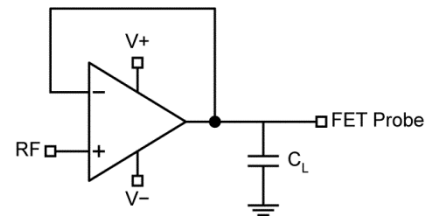

Test Circuit 6. Closed-Loop Unity Gain Frequency Response Measurement

DC Typical Characteristics

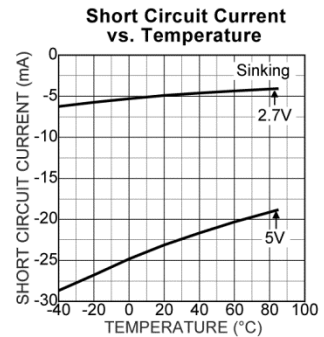
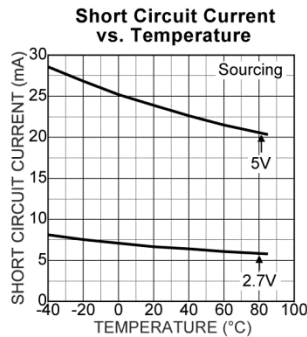
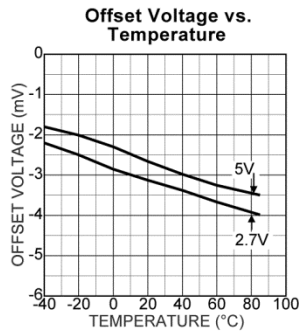
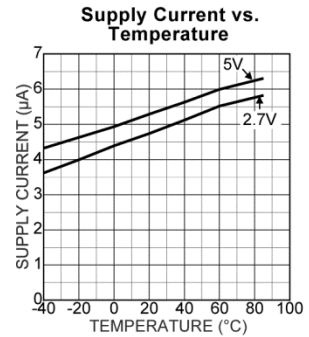
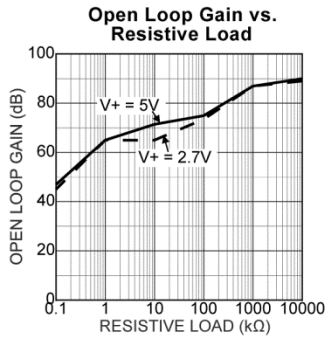
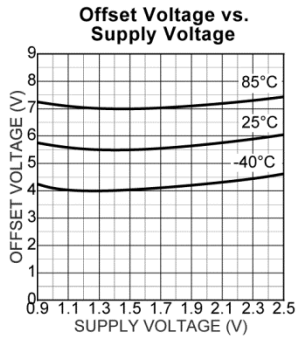
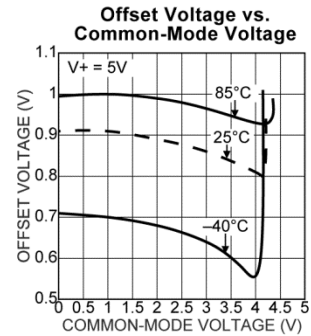
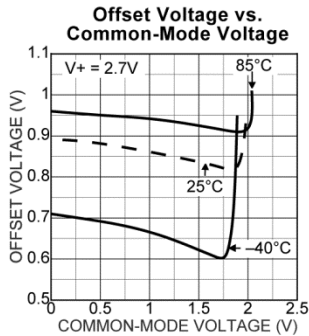
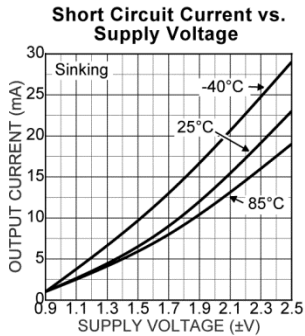
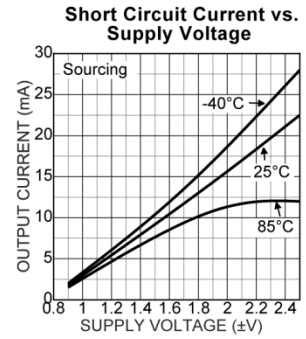
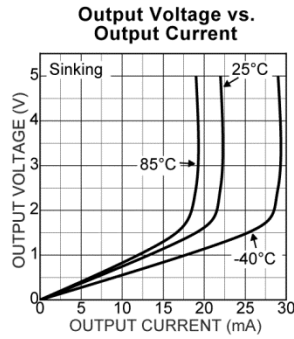
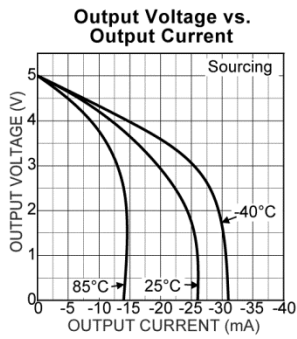

AC Typical Characteristics

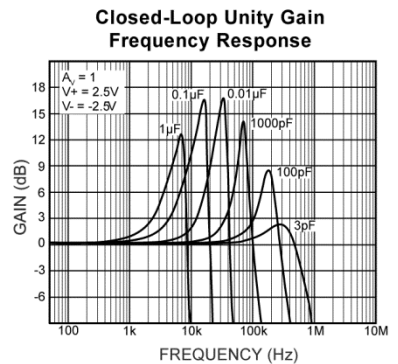
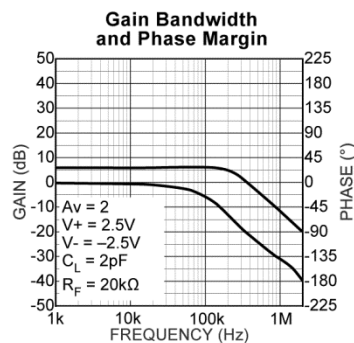
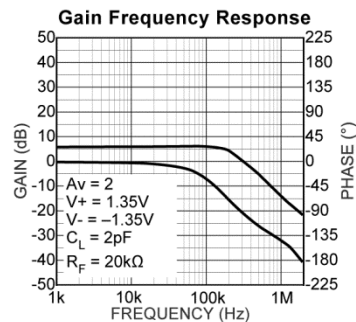
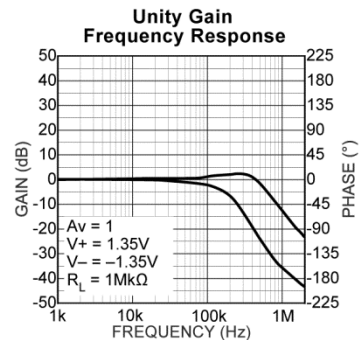
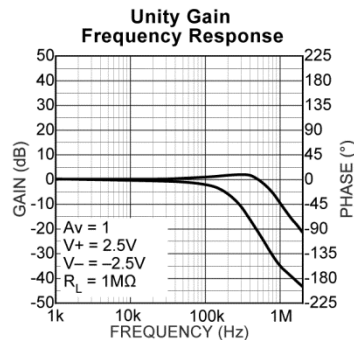
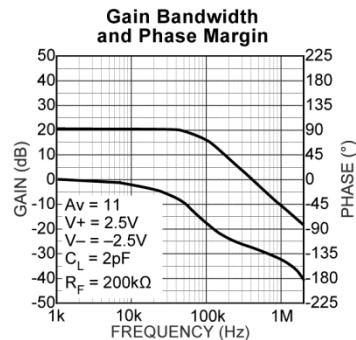
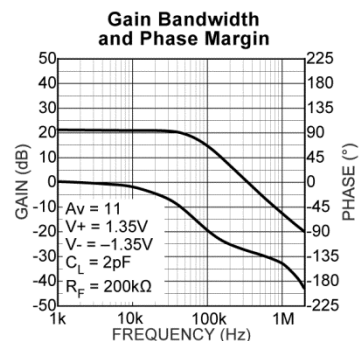
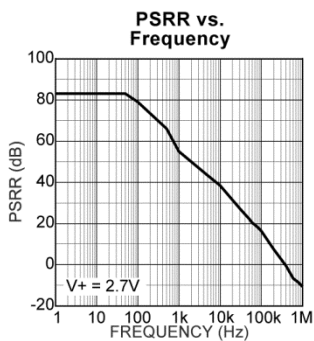
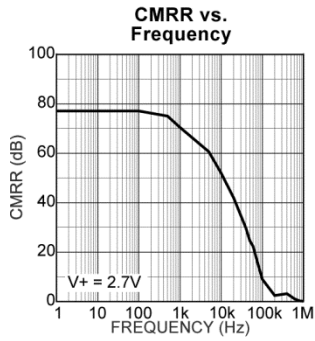
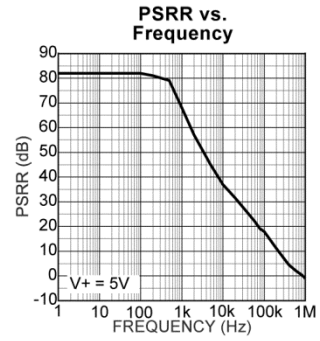
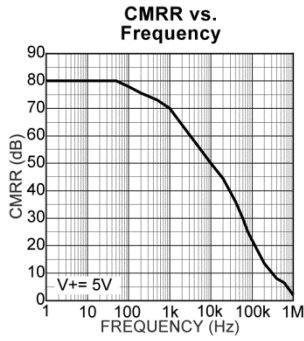
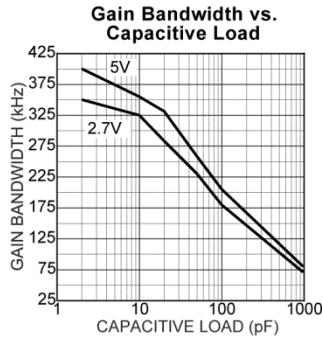

Functional Characteristics

Small Signal Pulse Response
Test Circuit 3: $A_V = 1$

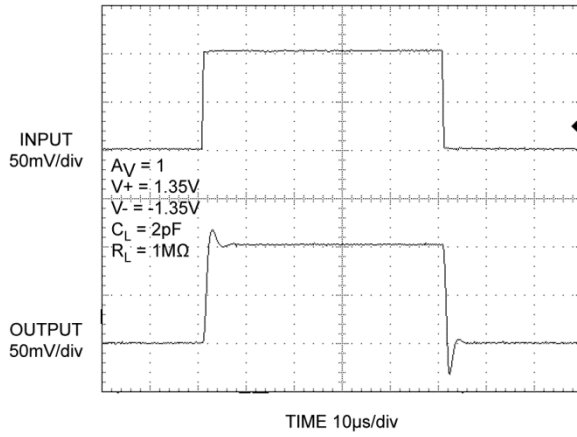

Small Signal Pulse Response
Test Circuit 3: $A_V = 1$

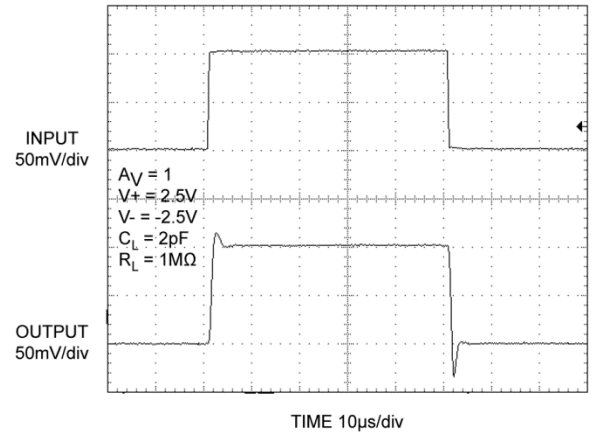

Small Signal Pulse Response
Test Circuit 3: $A_V = 1$

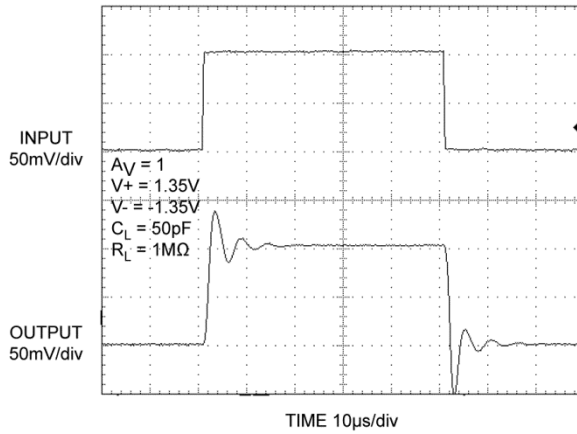

Small Signal Pulse Response
Test Circuit 3: $A_V = 1$

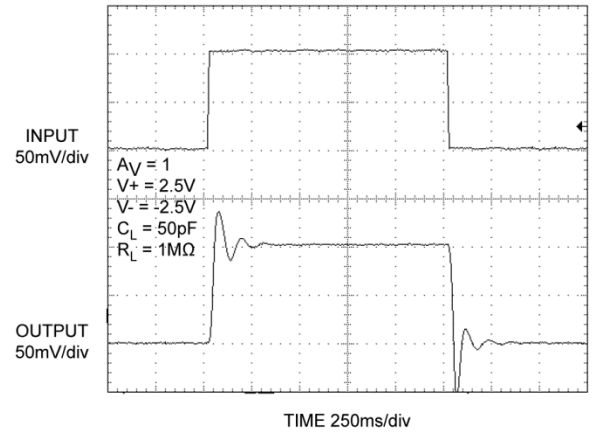

Small Signal Pulse Response
Test Circuit 4: $A_V = -1$

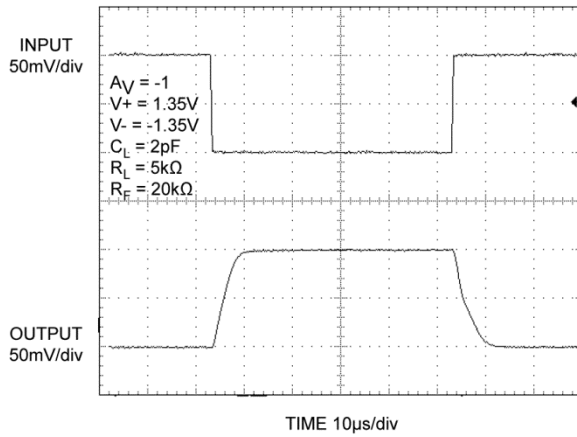

Small Signal Pulse Response
Test Circuit 4: $A_V = -1$

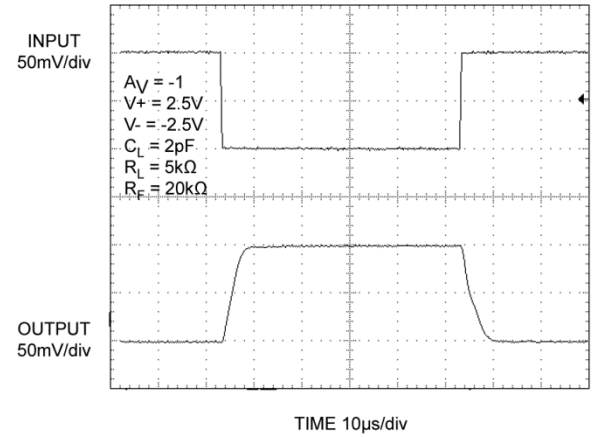

Functional Characteristics (Continued)

Small Signal Pulse Response
Test Circuit 4: $A_V = -1$

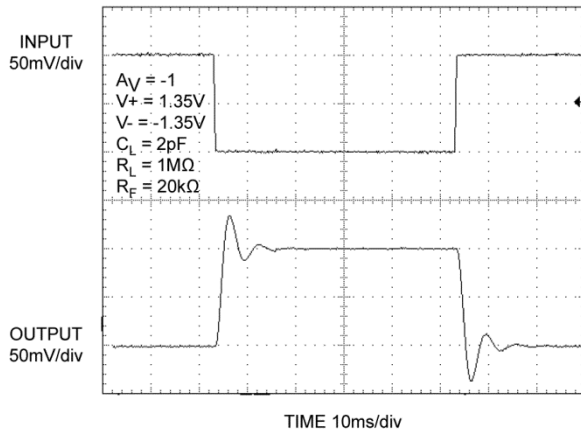

Small Signal Pulse Response
Test Circuit 4: $A_V = -1$

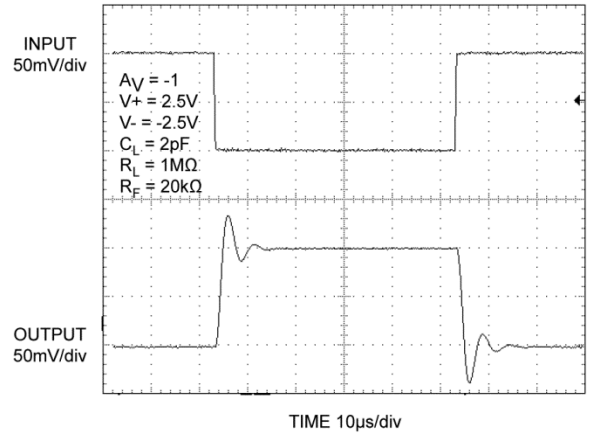

Rail to Rail Output Operation

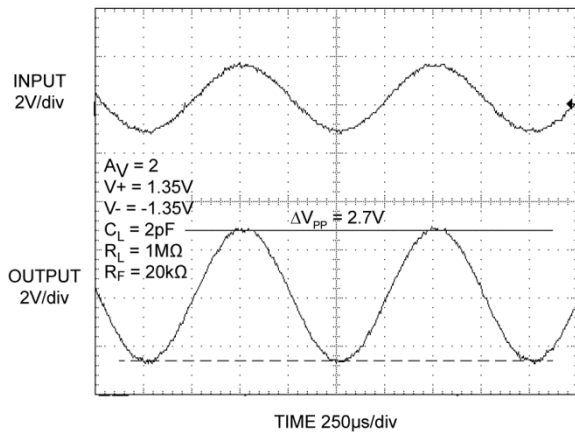

Rail to Rail Output Operation

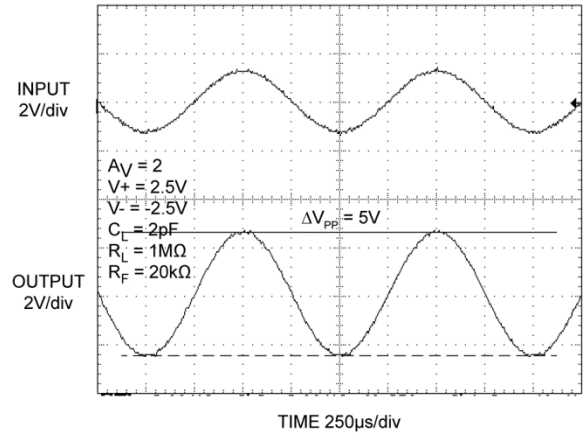

Rail to Rail Output Operation

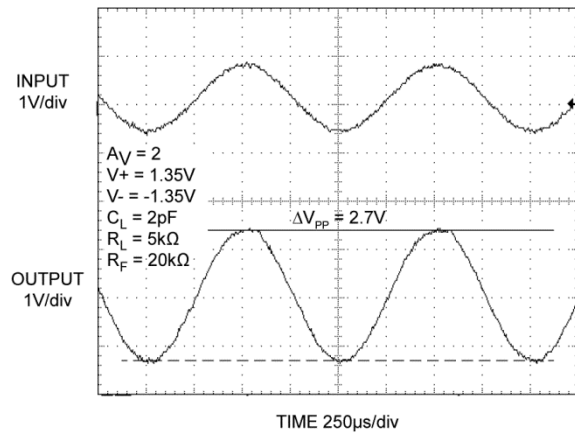

Rail to Rail Output Operation

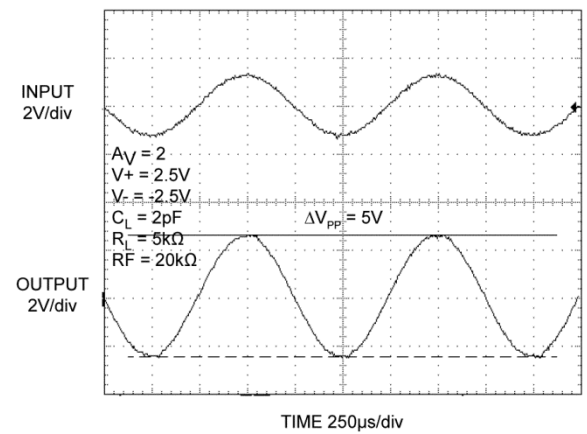

Functional Characteristics (Continued)

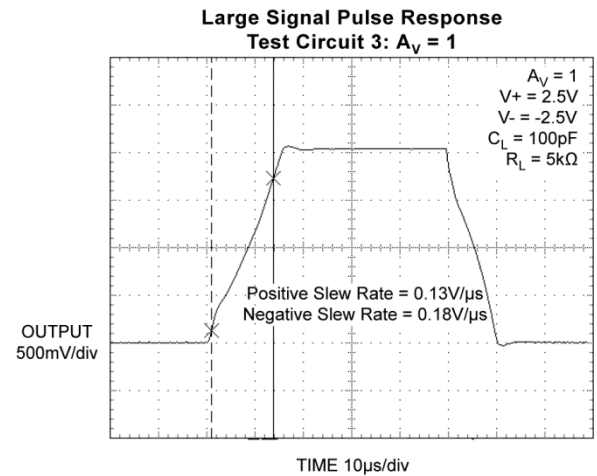
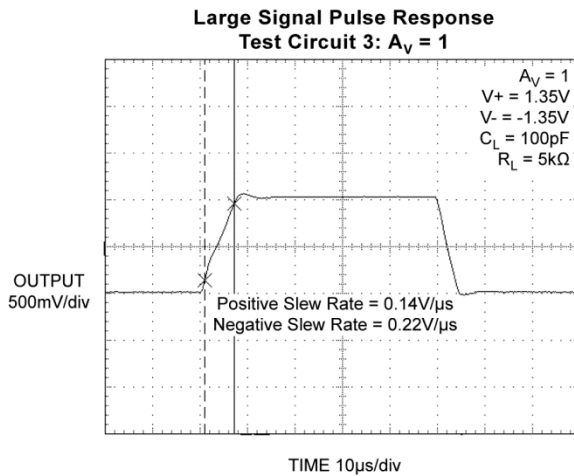

Applications Information

Regular supply bypassing techniques are recommended. A 10 μ F capacitor in parallel with a 0.1 μ F capacitor on both the positive and negative supplies is ideal. For best performance, all bypassing capacitors should be located

as close to the op amp as possible and all capacitors should be low equivalent series inductance (ESL) and equivalent series resistance (ESR). Surface-mount ceramic capacitors are ideal.

Package Information⁽⁷⁾

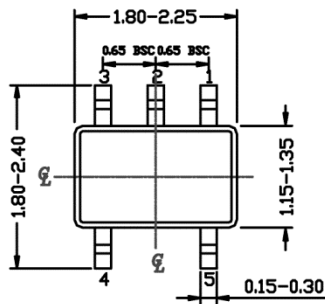

TOP VIEW

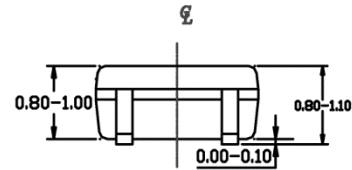

SIDE VIEW

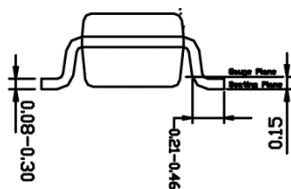

END VIEW

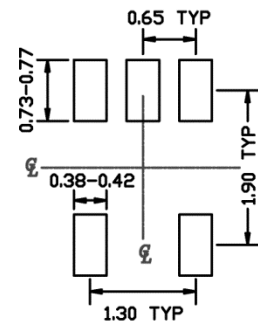

RECOMMENDED LAND PATTERN

NOTE:

1. ALL DIMENSIONS ARE IN MILLIMETERS.
2. DIMENSIONS ARE INCLUSIVE OF PLATING.
3. DIMENSIONS ARE EXCLUSIVE OF MOLD FLASH & METAL BURR.

5-Pin SC70 (C5)

Note:

7. Package information is correct as of the publication date. For updates and most current information, go to www.micrel.com.

MICREL, INC. 2180 FORTUNE DRIVE SAN JOSE, CA 95131 USA
 TEL +1 (408) 944-0800 FAX +1 (408) 474-1000 WEB <http://www.micrel.com>



Micrel makes no representations or warranties with respect to the accuracy or completeness of the information furnished in this data sheet. This information is not intended as a warranty and Micrel does not assume responsibility for its use. Micrel reserves the right to change circuitry, specifications and descriptions at any time without notice. No license, whether express, implied, arising by estoppel or otherwise, to any intellectual property rights is granted by this document. Except as provided in Micrel's terms and conditions of sale for such products, Micrel assumes no liability whatsoever, and Micrel disclaims any express or implied warranty relating to the sale and/or use of Micrel products including liability or warranties relating to fitness for a particular purpose, merchantability, or infringement of any patent, copyright or other intellectual property right.

Micrel Products are not designed or authorized for use as components in life support appliances, devices or systems where malfunction of a product can reasonably be expected to result in personal injury. Life support devices or systems are devices or systems that (a) are intended for surgical implant into the body or (b) support or sustain life, and whose failure to perform can be reasonably expected to result in a significant injury to the user. A Purchaser's use or sale of Micrel Products for use in life support appliances, devices or systems is a Purchaser's own risk and Purchaser agrees to fully indemnify Micrel for any damages resulting from such use or sale.

© 2014 Micrel, Incorporated.

Looking for pricing, stock, or lifecycle information?

Click below to explore more details on WIN SOURCE:

-  [View MIC861BC5 on WIN SOURCE](#)
-  [Microchip Technology](#) Information

Optimize Your Supply Chain with WIN SOURCE Solutions

-  Global Sourcing Solution
-  Obsolete Management
-  Cost Control Management
-  Shortage Management
-  Alternative Solution
-  Excess Inventory Management