



# MIC6270

## IttyBitty® Comparator

### General Description

The MIC6270 is a precision voltage comparator with an offset voltage specification of 5mV maximum.

The MIC6270 is designed to operate from a single 2V to 36V power supply. Operation from split power supplies is also possible. Its low supply current drain is independent of the magnitude of the supply voltage.

This comparator also features an input common-mode voltage range that includes ground. Inputs are protected against reverse polarity (input voltage less than  $V^-$ ) and ESD.

The MIC6270 has an open-collector output that directly interfaces with TTL, CMOS, and other types of logic. Several MIC6270 outputs can be connected together for wired-OR logic. The output also features an internal pull-up current source that can be used instead of an external load in some applications.

Data sheets and support documentation can be found on Micrel's web site at [www.micrel.com](http://www.micrel.com).

### Features

- 2V to 36V supply
- 300 $\mu$ A supply current independent of supply
- 25nA input bias current
- $\pm$ 5nA input offset current
- $\pm$ 3mV input offset voltage
- Input common-mode voltage range includes ground
- Differential input voltage range equal to the power supply voltage
- 250mV at 4mA output saturation voltage
- Output compatible with TTL, DTL, ECL, MOS, and CMOS logic

### Applications

- Limit comparators
- A/D converters
- Pulse, square wave, time delay generators
- Wide range VCO
- MOS clock timers
- Multi-vibrators and high-voltage digital logic gates

### Ordering Information

Part Number		Temperature Range	Package
Standard	Pb-Free		
MIC6270BM5	MIC6270YM5	-40° to +85°C	5-Pin SOT-23

### Pin Configuration

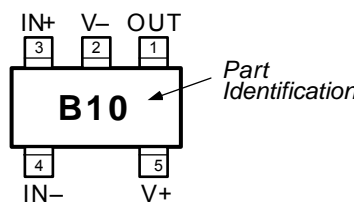

5-Pin SOT-23 (M5)

### Functional Configuration

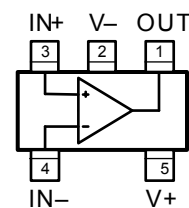

5-Pin SOT-23 (M5)

### Pin Description

Pin Number	Pin Name	Pin Function
1	OUT	Comparator Output
2	V-	Negative Supply: Negative supply for split supply application or ground for single supply application.
3	IN+	Non-inverting Input
4	IN-	Inverting Input
5	V+	Positive Supply

IttyBitty is a registered trademark of Micrel, Inc.

Micrel Inc. • 2180 Fortune Drive • San Jose, CA 95131 • USA • tel +1 (408) 944-0800 • fax + 1 (408) 474-1000 • <http://www.micrel.com>

## Absolute Maximum Ratings

Supply Voltage ( $V_{V+} - V_{V-}$ ).....	36V or $\pm 18V$
Differential Input Voltage ( $V_{IN+} - V_{IN-}$ ).....	$\pm 36V$
Input Voltage.....	$-0.3V$ to $+36V$
Input Current ( $V_{IN} < -0.3V$ ).....	50mA
Output Short-Circuit to GND, <b>Note 1</b> .....	$\infty$
Storage Temperature ( $T_s$ ).....	$-65^{\circ}C$ to $+150^{\circ}C$
Lead Temperature (soldering, 10sec.).....	$260^{\circ}C$

## Operating Ratings<sup>(2)</sup>

Supply Voltage.....	2V to $+36V$
Ambient Temperature ( $T_A$ ).....	$-40^{\circ}C$ to $+85^{\circ}C$
Thermal Resistance	
SOT-23-5 ( $\theta_{JA}$ ).....	$220^{\circ}C/W$
(mounted to printed circuit board)	

## Electrical Characteristics

$V+ = 5V$ ;  $T_A = 25^{\circ}C$ , **bold** values indicate  $-40^{\circ}C \leq T_A \leq +85^{\circ}C$ ,  $T_A = T_J$ ; unless noted.

Symbol	Parameter	Condition	Min	Typ	Max	Units
$V_{OS}$	Input Offset Voltage	<b>Note 2</b>		2	5 <b>9</b>	mV mV
$I_B$	Input Bias Current	$I_{IN(+)}$ or $I_{IN(-)}$ with output in linear range, $V_{CM} = 0V$ , <b>Note 3</b>		25	250 <b>400</b>	nA nA
$I_{OS}$	Input Offset Current	$I_{IN(+)} - I_{IN(-)}$ , $V_{CM} = 0V$		5	50 <b>150</b>	nA nA
$V_{CM}$	Input Voltage Range	$V+ = 30V$ , <b>Note 4</b>	0		$V+ - 1.5$ <b><math>V+ - 2</math></b>	V V
$I_S$	Supply Current	$R_L = \infty$ $R_L = \infty$ , $V+ = 36V$		0.3 0.4	0.9 1.2	mA mA
	Voltage Gain	$R_L \geq 15k\Omega$ , $V+ = 15V$ $V_O = 1V$ to $11V$	50	200		V/mV
	Large Signal Response Time	$V_{IN} =$ TTL logic swing, $V_{REF} = 1.4V$ $V_{RL} = 5V$ , $R_L = 5.1k\Omega$		300		ns
	Response Time	$V_{RL} = 5V$ , $R_L = 5.1k\Omega$ , <b>Note 5</b>		0.6		$\mu s$
	Output Sink Current	$V_{IN(-)} = 1V$ , $V_{IN(+)} = 0$ , $V_O \leq 1.5V$	10	20		mA
	Output Pull-Up Current			15	50	$\mu A$
	Saturation Voltage	$V_{IN(-)} = 1V$ , $V_{IN(+)} = 0$ , $I_{SINK} \leq 4mA$		250	400 <b>700</b>	mV mV
	Differential Input Voltage	$V_{IN(+)}$ , $V_{IN(-)} \geq 0V$ (or $V-$ , if used), <b>Note 6</b>			36	V

**General Note:** Devices are ESD protected; however, handling precautions are recommended.

1. A short circuit from OUT to  $V+$  can cause excessive heating and damage the device. The maximum short circuit output current (OUT to  $V-$ ) is approximately 20mA, independent of  $V_{V+}$ .
2. Measured at the output switch point where  $V_{OUT} \cong 1.4Vdc$  with  $R_S = 0\Omega$ ,  $V+ = 5Vdc$  to  $30Vdc$ , and over the full input common-mode range ( $0Vdc$  to  $V+ - 1.5Vdc$ ).
3. The direction of input current is out of the device due to its PNP input.
4. The input common-mode voltage,  $V_{IN+}$ , or  $V_{IN-}$  must not go below  $-0.3V$ . The upper end of the common-mode voltage range is  $V+ - 1.5V$  at  $25^{\circ}C$ , but either or both inputs can go to  $+36Vdc$  without damage, independent of  $V_{V+}$ .
5. The response time measured using a 100mV input step with 5mV overdrive. With greater overdrive, 300ns can be obtained. See "Typical Characteristics."
6. Positive excursions of input voltage may exceed the power supply level. As long as the other voltage remains within the common-mode range, the comparator will provide a proper output state. The low input voltage state must not be below  $-0.3Vdc$  (or  $0.3Vdc$  below  $V_{V-}$ ).

# Typical Characteristics

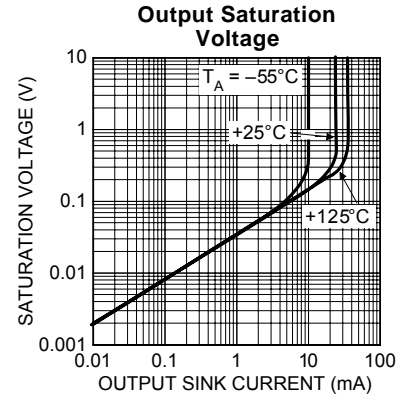
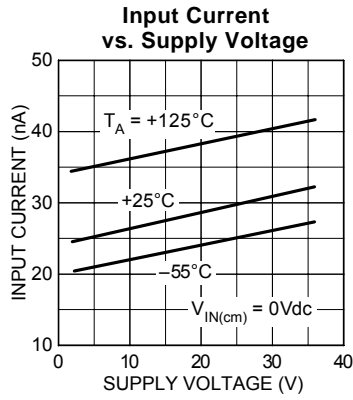
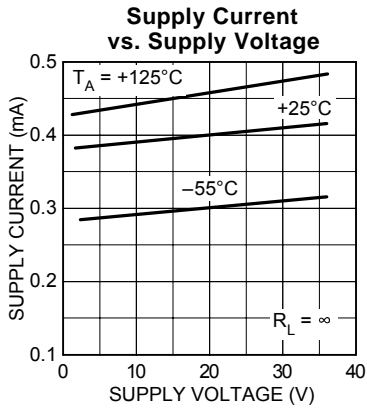

**Output Response Time vs. Overdrive (Test Circuit)**

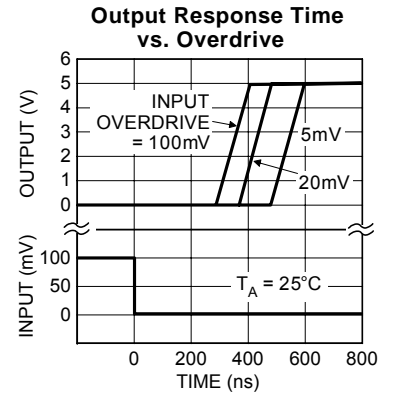
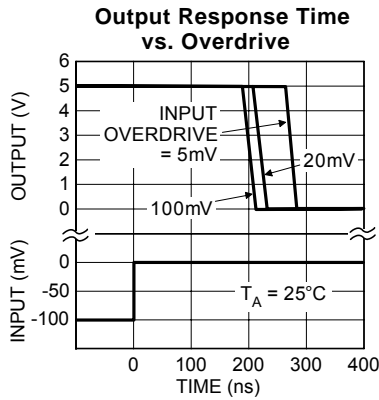
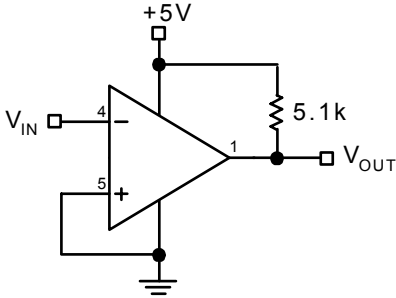

**Package Information**

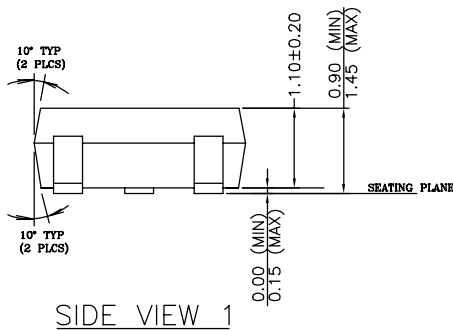
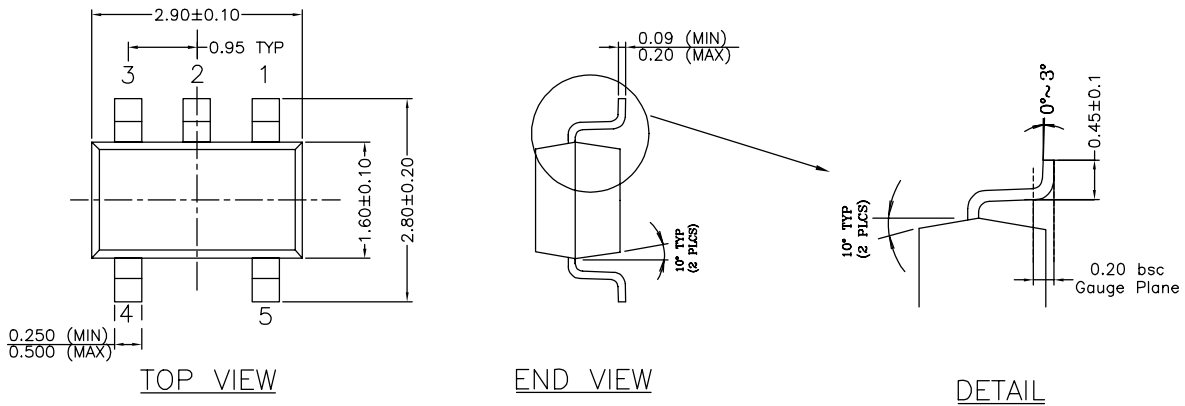

- NOTE:
1. PACKAGE OUTLINE EXCLUSIVE OF MOLD FLASH & BURR.
  2. PACKAGE OUTLINE INCLUSIVE OF SOLER PLATING.
  3. DIMENSION AND TOLERANCE PER ANSI Y14.5M, 1982.
  4. FOOT LENGTH MEASUREMENT BASED ON GAUGE PLANE METHOD.
  5. DIE FACES UP FOR MOLD, AND FACES DOWN FOR TRIM/FORM.
  6. ALL DIMENSIONS ARE IN MILLIMETERS.

**5-Pin SOT-23 (M5)**

**MICREL, INC. 2180 FORTUNE DRIVE SAN JOSE, CA 95131 USA**  
 TEL +1 (408) 944-0800 FAX +1 (408) 474-1000 WEB <http://www.micrel.com>

The information furnished by Micrel in this data sheet is believed to be accurate and reliable. However, no responsibility is assumed by Micrel for its use. Micrel reserves the right to change circuitry and specifications at any time without notification to the customer.

Micrel Products are not designed or authorized for use as components in life support appliances, devices or systems where malfunction of a product can reasonably be expected to result in personal injury. Life support devices or systems are devices or systems that (a) are intended for surgical implant into the body or (b) support or sustain life, and whose failure to perform can be reasonably expected to result in a significant injury to the user. A Purchaser's use or sale of Micrel Products for use in life support appliances, devices or systems is a Purchaser's own risk and Purchaser agrees to fully indemnify Micrel for any damages resulting from such use or sale.

© 1998 Micrel, Incorporated.

## Looking for pricing, stock, or lifecycle information?

Click below to explore more details on WIN SOURCE:

- ⊖ [View MIC6270YM5-TR on WIN SOURCE](#)
- ⊖ [Microchip Technology](#) Information

## Optimize Your Supply Chain with WIN SOURCE Solutions

- ✓ Global Sourcing Solution
- ✓ Obsolete Management
- ✓ Cost Control Management
- ✓ Shortage Management
- ✓ Alternative Solution
- ✓ Excess Inventory Management