



# THE DATASHEET OF MIC5014YM



### General Description

MIC5014 and MIC5015 MOSFET drivers are designed for gate control of N-channel, enhancement-mode, power MOSFETs used as high-side or low-side switches. The MIC5014/5 can sustain an on-state output indefinitely.

The MIC5014/5 operates from a 2.75V to 30V supply. In high-side configurations, the driver can control MOSFETs that switch loads of up to 30V. In low-side configurations, with separate supplies, the maximum switched voltage is limited only by the MOSFET.

The MIC5014/5 has a TTL compatible control input. The MIC5014 is noninverting while the MIC5015 is inverting.

The MIC5014/5 features an internal charge pump that can sustain a gate voltage greater than the available supply voltage. The driver is capable of turning on a logic-level MOSFET from a 2.75V supply or a standard MOSFET from a 5V supply. The gate-to-source output voltage is internally limited to approximately 15V.

The MIC5014/5 is protected against automotive load dump, reversed battery, and inductive load spikes of -20V. The driver's overvoltage shutdown feature turns off the external MOSFET at approximately 35V to protect the load against power supply excursions.

The MIC5014 is an improved pin-for-pin compatible replacement in many MIC5011 applications.

The MIC5014/5 is available in plastic 8-pin DIP and 8-pin SOIC packages.

### Features

- 2.75V to 30V operation
- 100 $\mu$ A maximum supply current (5V supply)
- 15 $\mu$ A typical off-state current
- Internal charge pump
- TTL compatible input
- Withstands 60V transient (load dump)
- Reverse battery protected to -20V
- Inductive spike protected to -20V
- Overvoltage shutdown at 35V
- Internal 15V gate protection
- Minimum external parts
- Operates in high-side or low-side configurations
- 1 $\mu$ A control input pull-off
- Inverting and noninverting versions

### Applications

- Automotive electrical load control
- Battery-powered computer power management
- Lamp control
- Heater control
- Motor control
- Power bus switching

### Typical Application

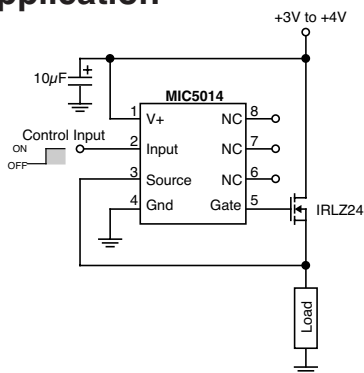
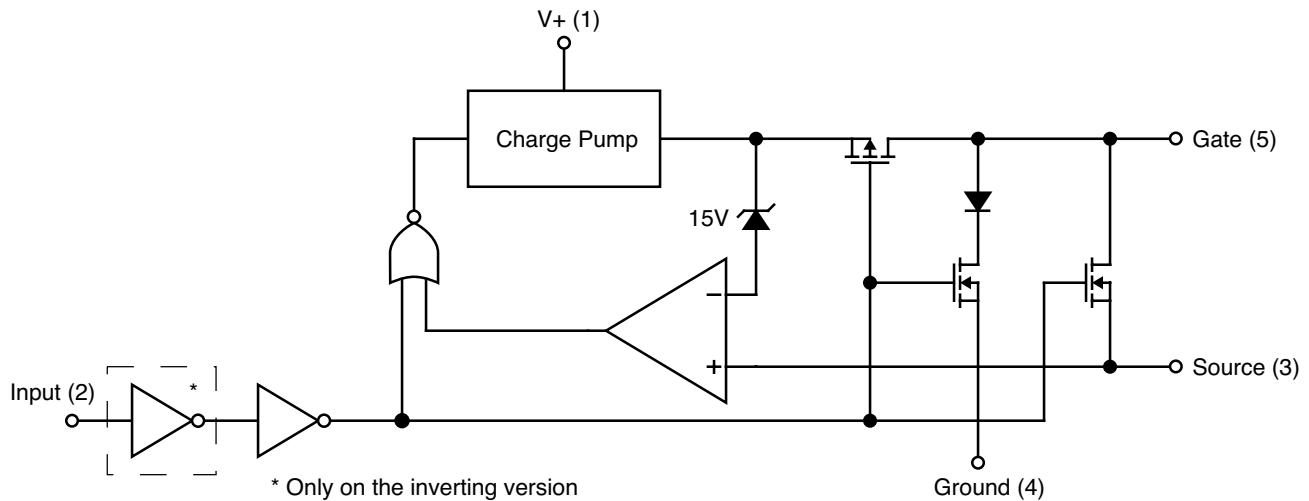

**Figure 1. 3V "Sleep-Mode" Switch with a Logic-Level MOSFET**

## Ordering Information

Part Number		Temperature Range	Configuration	Package
Standard	Pb-Free			
MIC5014BM	MIC5014YM	-40°C to +85°C	Non-Inverting	8-Pin SOIC
MIC5014BN	MIC5014YN	-40°C to +85°C	Non-Inverting	8-Pin PDIP
MIC5015BM	MIC5015YM	-40°C to +85°C	Inverting	8-Pin SOIC
MIC5015BN	MIC5015YN	-40°C to +85°C	Inverting	8-Pin PDIP

## Block Diagram



## Pin Description

Pin Number	Pin Name	Pin Function
1	V+	Supply. Must be decoupled to isolate from large transients caused by the power MOSFET drain. 10 $\mu$ F is recommended close to pins 1 and 4.
2	Input	Turns on power MOSFET when taken above (or below) threshold (1.0V typical). Pin 2 requires ~1 $\mu$ A to switch.
3	Source	Connects to source lead of power MOSFET and is the return for the gate clamp zener. Pin 3 can safely swing to -20V when turning off inductive loads.
4	Ground	
5	Gate	Drives and clamps the gate of the power MOSFET.
6, 7, 8	NC	Not internally connected.

**Absolute Maximum Ratings** (Notes 1,2)

Supply Voltage .....	-20V to 60V
Input Voltage .....	-20V to V <sup>+</sup>
Source Voltage .....	-20V to V <sup>+</sup>
Source Current .....	50mA
Gate Voltage .....	-20V to 50V
Junction Temperature .....	150°C

**Operating Ratings** (Notes 1,2)

$\theta_{JA}$ (Plastic DIP) .....	160°C/W
$\theta_{JA}$ (SOIC) .....	170°C/W
Ambient Temperature: .....	-40°C to +85°C
Storage Temperature .....	-65°C to +150°C
Lead Temperature .....	260°C
(max soldering time: 10 seconds)	
Supply Voltage (V <sup>+</sup> ) .....	2.75V to 30V

**Electrical Characteristics** (Note 3) T<sub>A</sub> = -40°C to +85°C unless otherwise specified

Parameter	Conditions		Min	Typ	Max	Units
Supply Current	V <sup>+</sup> = 30V	V <sub>IN</sub> De-Asserted (Note 5)		10	25	μA
		V <sub>IN</sub> Asserted (Note 5)		5.0	10	mA
	V <sup>+</sup> = 5V	V <sub>IN</sub> De-Asserted		10	25	μA
		V <sub>IN</sub> Asserted		60	100	
	V <sup>+</sup> = 3V	V <sub>IN</sub> De-Asserted		10	25	μA
		V <sub>IN</sub> Asserted		25	35	
Logic Input Voltage Threshold V <sub>IN</sub>	3.0V ≤ V <sup>+</sup> ≤ 30V T <sub>A</sub> = 25°C	Digital Low Level			0.8	V
		Digital High Level	2.0			
Logic Input Current MIC5014 (non-inverting)	3.0V ≤ V <sup>+</sup> ≤ 30V	V <sub>IN</sub> Low	-2.0	0		μA
		V <sub>IN</sub> High		1.0	2.0	
Logic Input Current MIC5015 (inverting)	3.0V ≤ V <sup>+</sup> ≤ 30V	V <sub>IN</sub> Low	-2.0	-1.0		μA
		V <sub>IN</sub> High		-1.0	2.0	
Input Capacitance				5.0		pF
Gate Enhancement V <sub>GATE</sub> - V <sub>SUPPLY</sub>	3.0V ≤ V <sup>+</sup> ≤ 30V	V <sub>IN</sub> Asserted	4.0		17	V
Zener Clamp V <sub>GATE</sub> - V <sub>SOURCE</sub>	8.0V ≤ V <sup>+</sup> ≤ 30V	V <sub>IN</sub> Asserted	13	15	17	V
Gate Turn-on Time, t <sub>ON</sub> (Note 4)	V <sup>+</sup> = 4.5V C <sub>L</sub> = 1000pF	V <sub>IN</sub> switched on, measure time for V <sub>GATE</sub> to reach V <sup>+</sup> + 4V		2.5	8.0	ms
	V <sup>+</sup> = 12V C <sub>L</sub> = 1000pF	As above, measure time for V <sub>GATE</sub> to reach V <sup>+</sup> + 4V		90	140	μs
Gate Turn-off Time, t <sub>OFF</sub> (Note 4)	V <sup>+</sup> = 4.5V C <sub>L</sub> = 1000pF	V <sub>IN</sub> switched off, measure time for V <sub>GATE</sub> to reach 1V		6.0	30	μs
	V <sup>+</sup> = 12V C <sub>L</sub> = 1000pF	As above, measure time for V <sub>GATE</sub> to reach 1V		6.0	30	μs
Overshoot Shutdown Threshold			35	37	41	V

**Note 1: Absolute Maximum Ratings** indicate limits beyond which damage to the device may occur. Electrical specifications do not apply when operating the device beyond its specified **Operating Ratings**.

**Note 2:** The MIC5014/5015 is ESD sensitive.

**Note 3:** Minimum and maximum **Electrical Characteristics** are 100% tested at T<sub>A</sub> = 25°C and T<sub>A</sub> = 85°C, and 100% guaranteed over the entire operating temperature range. Typicals are characterized at 25°C and represent the most likely parametric norm.

**Note 4:** Test conditions reflect worst case high-side driver performance. Low-side and bootstrapped topologies are significantly faster — see Applications Information.

**Note 5:** “Asserted” refers to a logic high on the MIC5014 and a logic low on the MIC5015.

**Typical Characteristics** All data measured using FET probe to minimize resistive loading

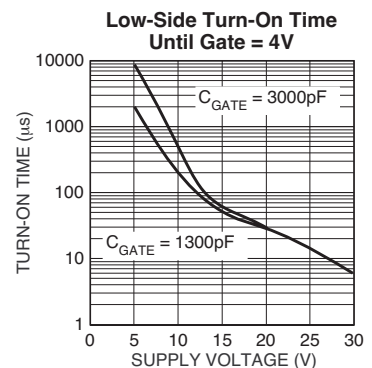
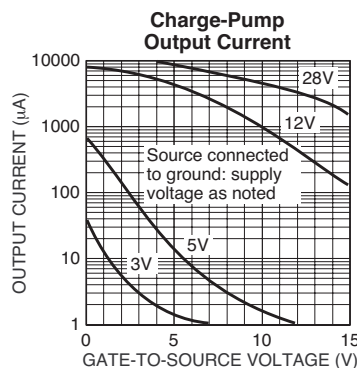
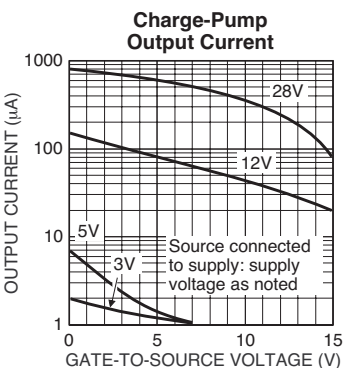
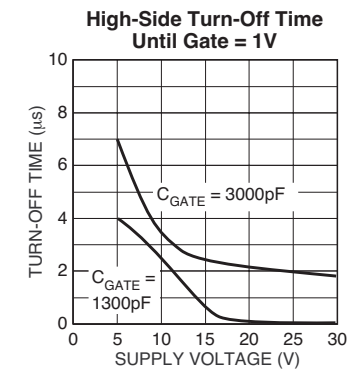
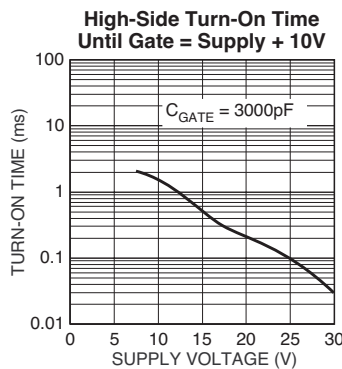
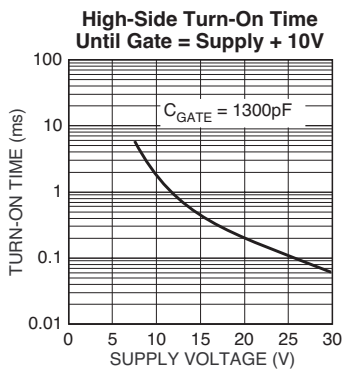
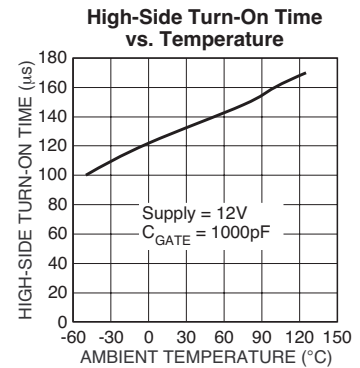
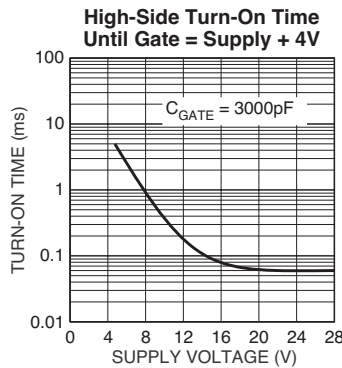
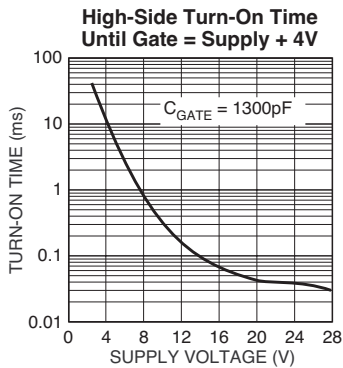
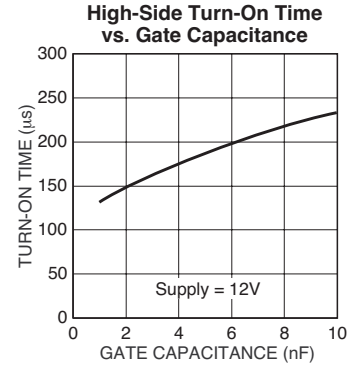
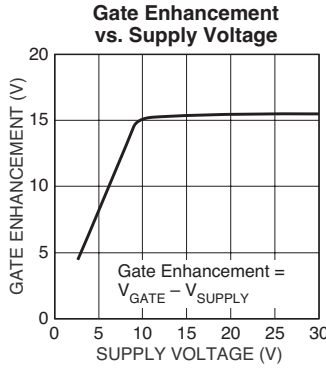
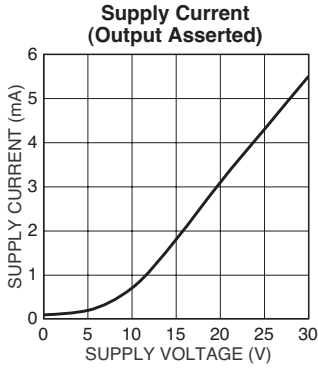

## Applications Information

### Functional Description

The MIC5014 is functionally and pin for pin compatible with the MIC5011, except for the omission of the optional speed-up capacitor pins, which are available on the MIC5011. The MIC5015 is an inverting configuration of the MIC5014.

The internal functions of these devices are controlled via a logic block (refer to block diagram) connected to the control input (pin 2). When the input is off (low for the MIC5014, and high for the MIC5015), all functions are turned off, and the gate of the external power MOSFET is held low via two N-channel switches. This results in a very low standby current; 15 $\mu$ A typical, which is necessary to power an internal bandgap. When the input is driven to the “ON” state, the N-channel switches are turned off, the charge pump is turned on, and the P-channel switch between the charge pump and the gate turns on, allowing the gate of the power FET to be charged. The op amp and internal zener form an active regulator which shuts off the charge pump when the gate voltage is high enough. This is a feature not found on the MIC5011.

The charge pump incorporates a 100kHz oscillator and on-chip pump capacitors capable of charging a 1,000pF load in 90 $\mu$ s typical. In addition to providing active regulation, the internal 15V zener is included to prevent exceeding the  $V_{GS}$  rating of the power MOSFET at high supply voltages.

The MIC5014/15 devices have been improved for greater ruggedness and durability. All pins can withstand being pulled 20V below ground without sustaining damage, and the supply pin can withstand an overvoltage transient of 60V for 1s. An overvoltage shutdown has also been included, which turns off the device when the supply exceeds 35V.

### Construction Hints

High current pulse circuits demand equipment and assembly techniques that are more stringent than normal, low current lab practices. The following are the sources of pitfalls most often encountered during prototyping: Supplies: Many bench power supplies have poor transient response. Circuits that are being pulse tested, or those that operate by pulse-width modulation will produce strange results when used with a supply that has poor ripple rejection, or a peaked transient response. Always monitor the power supply voltage that appears at the drain of a high side driver (or the supply side of the load for a low side driver) with an oscilloscope. It is not uncommon to find bench power supplies in the 1kW class that overshoot or undershoot by as much as 50% when pulse loaded. Not only will the load current and voltage measurements be affected, but it is possible to overstress various components, especially electrolytic capacitors, with possibly catastrophic results. A 10 $\mu$ F supply bypass capacitor at the chip is recommended. Residual resistances: Resistances in circuit connections may also cause confusing results. For example, a circuit may employ a 50m $\Omega$  power MOSFET for low voltage drop, but unless careful construction techniques are used, one could easily add 50 to 100m $\Omega$  resistance. Do

not use a socket for the MOSFET. If the MOSFET is a TO-220 type package, make high current connections to the drain tab. Wiring losses have a profound effect on high-current circuits. A floating milliohmeter can identify connections that are contributing excess drop under load.

### Low Voltage Testing

As the MIC5014/MIC5015 have relatively high output impedances, a normal oscilloscope probe will load the device. This is especially pronounced at low voltage operation. It is recommended that a FET probe or unity gain buffer be used for all testing.

### Circuit Topologies

The MIC5014 and MIC5015 are well suited for use with standard power MOSFETs in both low and high side driver configurations. In addition, the lowered supply voltage requirements of these devices make them ideal for use with logic level FETs in high side applications with a supply voltage of 3 to 4V. (If higher supply voltages [ $>4V$ ] are used with logic level FETs, an external zener clamp must be supplied to ensure that the maximum  $V_{GS}$  rating of the logic FET [10V] is not exceeded.) In addition, a standard IGBT can be driven using these devices.

Choice of one topology over another is usually based on speed vs. safety. The fastest topology is the low side driver, however, it is not usually considered as safe as high side driving as it is easier to accidentally short a load to ground than to  $V_{CC}$ . The slowest, but safest topology is the high side driver; with speed being inversely proportional to supply voltage. It is the preferred topology for most military and automotive applications. Speed can be improved considerably by bootstrapping from the supply.

All topologies implemented using these devices are well suited to driving inductive loads, as either the gate or the source pin can be pulled 20V below ground with no effect. External clamp diodes are unnecessary, except for the case in which a transient may exceed the overvoltage trip point.

**High Side Driver** (Figure 1) The high side topology shown here is an implementation of a “sleep-mode” switch for a laptop or notebook computer which uses a logic level FET. A standard power FET can easily be substituted when supply voltages above 4V are required.

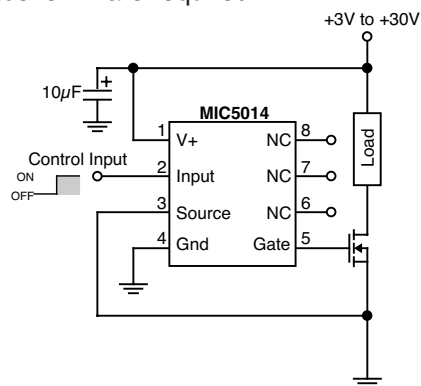

Figure 2. Low Side Driver



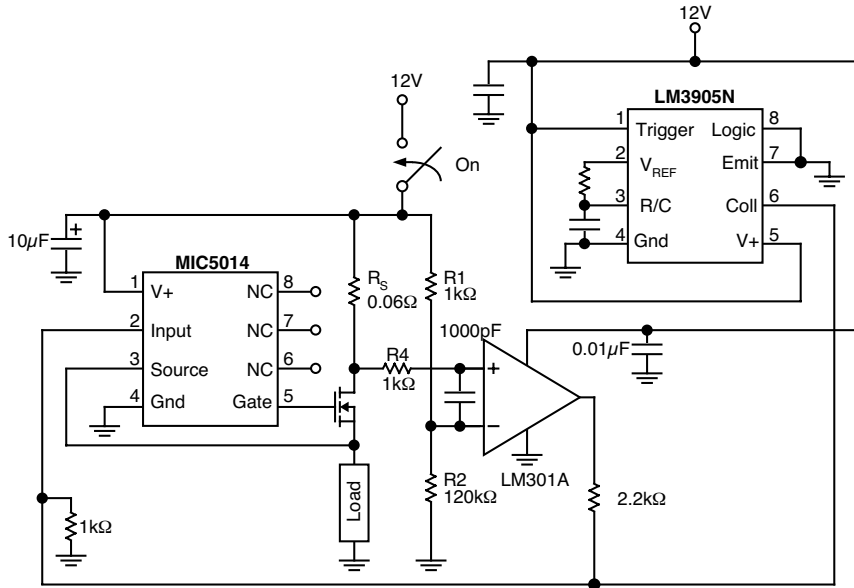

Figure 5. High Side Driver with Delayed Overcurrent Shutdown

**Typical Applications**

**Variable Supply Low Side Driver for Motor Speed Control** (Figure 6) The internal regulation in the MIC5014/15 allows a steady gate enhancement to be supplied while the MIC5014/15 supply varies from 5V to 30V, without damaging the internal gate to source zener clamp. This allows the speed of the DC motor shown to be varied by varying the supply voltage.

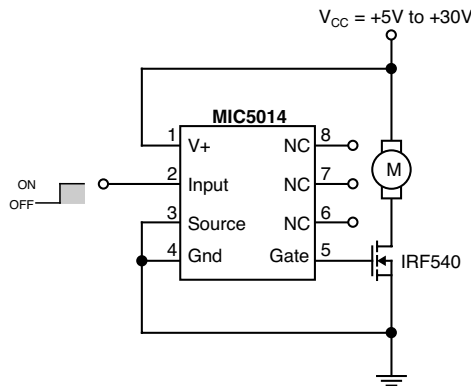

Figure 6: DC Motor Speed Control/Driver

**Solenoid Valve Driver** (Figure 7) High power solenoid valves are used in many industrial applications requiring the timed dispensing of chemicals or gases. When the solenoid is activated, the valve opens (or closes), releasing (or stopping) fluid flow. A solenoid valve, like all inductive loads, has a considerable “kickback” voltage when turned off, as current cannot change instantaneously through an inductor. In most

applications, it is acceptable to allow this voltage to momentarily turn the MOSFET back on as a way of dissipating the inductor’s current. However, if this occurs when driving a solenoid valve with a fast switching speed, chemicals or gases may be inadvertently be dispensed at the wrong time with possibly disastrous consequences. Also, too large of a kickback voltage (as is found in larger solenoids) can damage the MIC5014 or the power FET by forcing the Source node below ground (the MIC5014 can be driven up to 20V below ground before this happens). A catch diode has been included in this design to provide an alternate route for the inductive kickback current to flow. The 5kΩ resistor in series with this diode has been included to set the recovery time of the solenoid valve.

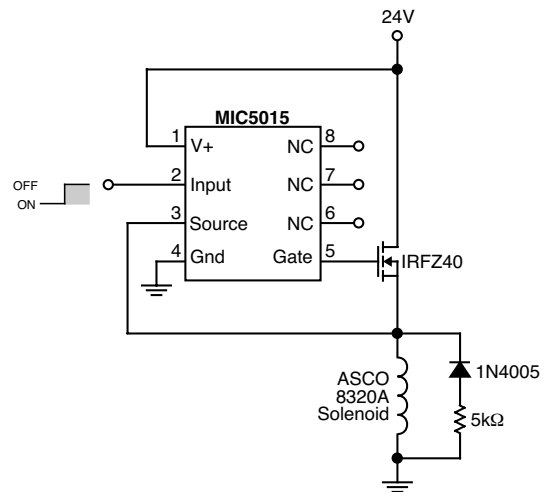

Figure 7: Solenoid Valve Driver

**Incandescent/Halogen Lamp Driver** (Figure 8) The combination of an MIC5014/5015 and a power FET makes an effective driver for a standard incandescent or halogen lamp load. Such loads often have high inrush currents, as the resistance of a cold filament is less than one-tenth as much as when it is hot. Power MOSFETs are well suited to this application as they have wider safe operating areas than do power bipolar transistors. It is important to check the SOA curve on the data sheet of the power FET to be used against the estimated or measured inrush current of the lamp in question prior to prototyping to prevent “explosive” results.

If overcurrent sense is to be used, first measure the duration of the inrush, then use the topology of Figure 5 with the RC of the timer chosen to accommodate the duration with suitable guardbanding.

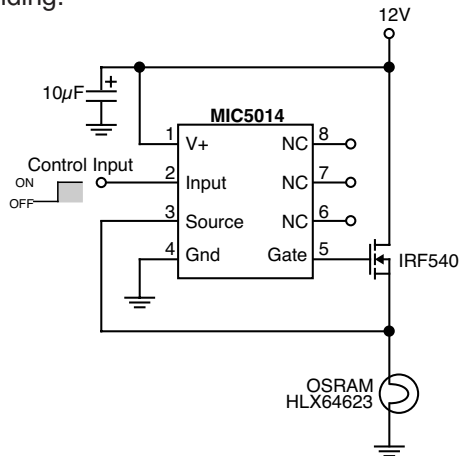

Figure 8. Halogen Lamp Driver

**Relay Driver** (Figure 9) Some power relay applications require the use of a separate switch or drive control, such as in the case of microprocessor control of banks of relays where a logic level control signal is used, or for drive of relays with high power requirements. The combination of an MIC5014/5015 and a power FET also provides an elegant solution to power relay drive.

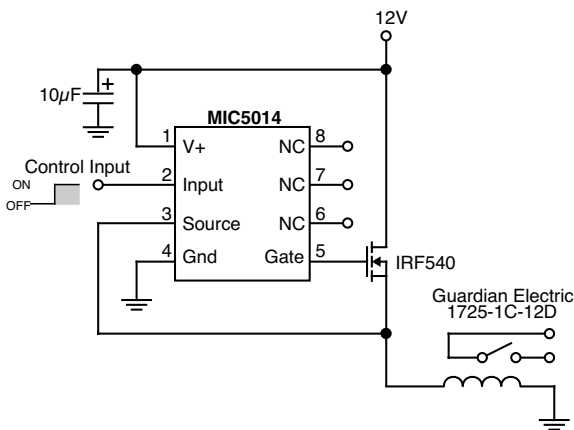

Figure 9: Relay Driver

**Motor Driver With Stall Shutdown** (Figure 10) Tachometer feedback can be used to shut down a motor driver circuit when a stall condition occurs. The control switch is a 3-way type; the “START” position is momentary and forces the driver ON. When released, the switch returns to the “RUN” position, and the tachometer’s output is used to hold the MIC5014 input ON. If the motor slows down, the tach output is reduced, and the MIC5014 switches OFF. Resistor “R” sets the shutdown threshold.

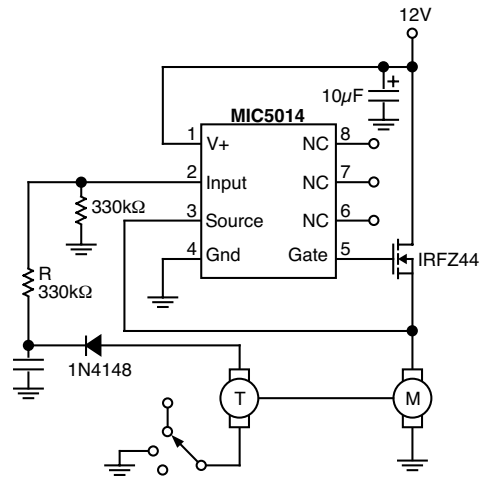

Figure 10. Motor Stall Shutdown

**Simple DC-DC Converter** (Figure 11) The simplest application for the MIC5014 is as a basic one-chip DC-DC converter. As the output (Gate) pin has a relatively high impedance, the output voltage shown will vary significantly with applied load.

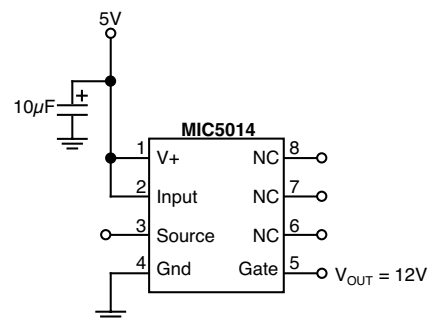
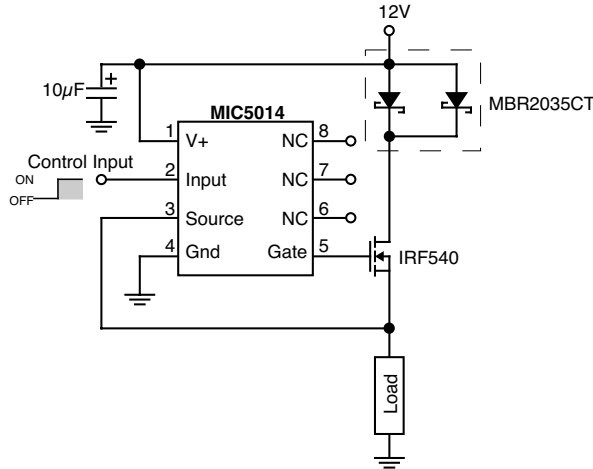

Figure 11. DC - DC Converter

**High Side Driver With Load Protection** (Figure 12) Although the MIC5014/15 devices are reverse battery protected, the load and power FET are not, in a typical high side configuration. In the event of a reverse battery condition, the internal body diode of the power FET will be forward biased. This allows the reversed supply access to the load.

The addition of a Schottky diode between the supply and the FET eliminates this problem. The MBR2035CT was chosen as it can withstand 20A continuous and 150A peak, and should survive the rigors of an automotive environment. The two diodes are paralleled to reduce switch loss (forward voltage drop).

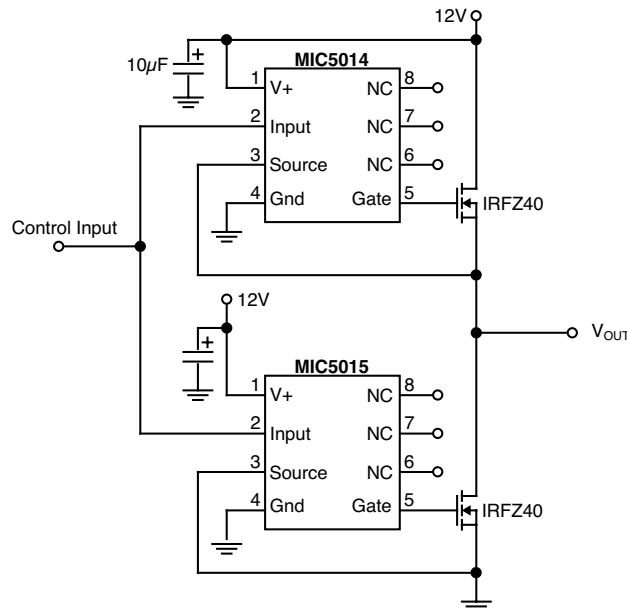

**Figure 12: High Side Driver With Load Protection**

**Push-Pull Driver With No Cross-Conduction** (Figure 13) As the turn-off time of the MIC5014/15 devices is much faster than the turn-on time, a simple push-pull driver with no cross conduction can be made using one MIC5014 and one MIC5015. The same control signal is applied to both inputs; the MIC5014 turns on with the positive signal, and the MIC5015 turns on when it swings low. This scheme works with no additional components as the relative time difference between the rise and fall times of the MIC5014 is large. However, this does mean that there is

considerable deadtime (time when neither driver is turned on). If this circuit is used to drive an inductive load, catch diodes must be used on each half to provide an alternate path for the kickback current that will flow during this deadtime.

This circuit is also a simple half H-bridge which can be driven with a PWM signal on the input for SMPS or motor drive applications in which high switching frequencies are not desired.



**Figure 13: Push-Pull Driver**

Package Information

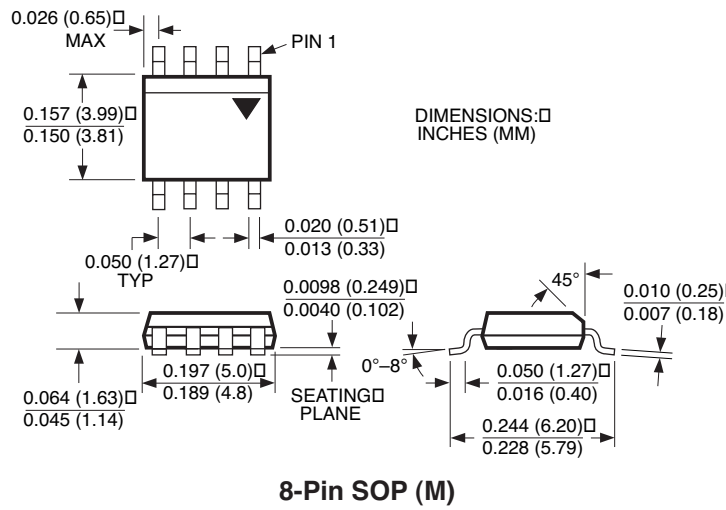
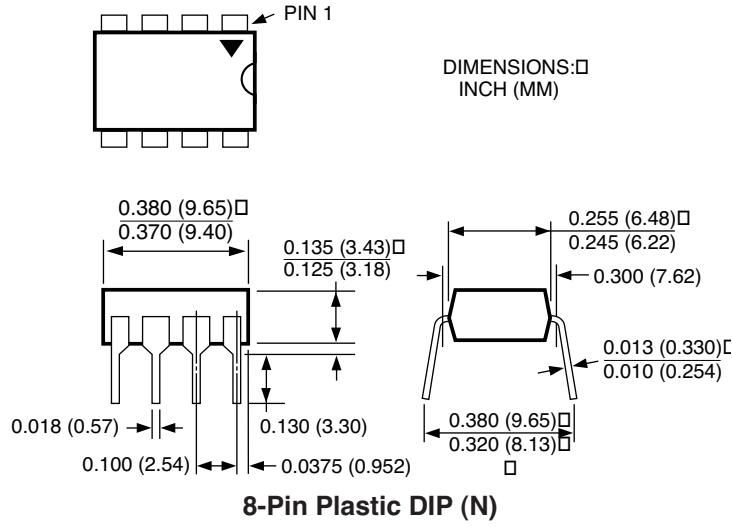



---

**MICREL INC. 2180 FORTUNE DRIVE SAN JOSE, CA 95131 USA**TEL + 1 (408) 944-0800 FAX + 1 (408) 474-1000 WEB <http://www.micrel.com>



This information furnished by Micrel in this data sheet is believed to be accurate and reliable. However no responsibility is assumed by Micrel for its use. Micrel reserves the right to change circuitry and specifications at any time without notification to the customer.

Micrel Products are not designed or authorized for use as components in life support appliances, devices or systems where malfunction of a product can reasonably be expected to result in personal injury. Life support devices or systems are devices or systems that (a) are intended for surgical implant into the body or (b) support or sustain life, and whose failure to perform can be reasonably expected to result in a significant injury to the user. A Purchaser's use or sale of Micrel Products for use in life support appliances, devices or systems is a Purchaser's own risk and Purchaser agrees to fully indemnify Micrel for any damages resulting from such use or sale.

© 1997 Micrel Incorporated

## Looking for pricing, stock, or lifecycle information?

Click below to explore more details on WIN SOURCE:

-  [View MIC5014YM on WIN SOURCE](#)
-  [Microchip Technology](#) Information

## Optimize Your Supply Chain with WIN SOURCE Solutions

-  Global Sourcing Solution
-  Obsolete Management
-  Cost Control Management
-  Shortage Management
-  Alternative Solution
-  Excess Inventory Management