

Dual 1.5A-Peak Low-Side MOSFET Drivers

Features

- Bipolar/CMOS/DMOS Construction
- Latch-Up Protected to >500 mA Reverse Current
- 1.5A-Peak Output Current
- 4.5V to 18V Operating Range
- Low Quiescent Supply Current
 - 4 mA at Logic 1 Input
 - 400 μ A at Logic 0 Input
- Switches 1000 pF in 25 ns
- Matched Rise and Fall Times
- 7 Ω Output Impedance
- <40 ns Typical Delay
- Logic-Input Threshold Independent of Supply Voltage
- Logic-Input Protection to -5V
- 6 pF Typical Equivalent Input Capacitance
- 25 mV Max. Output Offset from Supply or Ground
- Replaces MIC426/7/8 and MIC1426/7/8
- Dual inverting, dual non-inverting, and inverting/non-inverting configurations
- ESD Protection

Applications

- MOSFET Driver
- Clock Line Driver
- Coax Cable Driver
- Piezoelectric Transducer Driver

General Description

The MIC4426/4427/4428 family are highly reliable dual low-side MOSFET drivers fabricated on a BiCMOS/DMOS process for low power consumption and high efficiency. These drivers translate TTL or CMOS input logic levels to output voltage levels that swing within 25 mV of the positive supply or ground. Comparable bipolar devices are capable of swinging only to within 1V of the supply. The MIC4426/7/8 is available in three configurations: dual inverting, dual non-inverting, and one inverting plus one non-inverting output.

The MIC4426/4427/4428 are pin-compatible replacements for the MIC426/427/428 and MIC1426/1427/1428 with improved electrical performance and rugged design. They can withstand up to 500 mA of reverse current (either polarity) without latching and up to 5V noise spikes (either polarity) on ground pins.

Primarily intended for driving power MOSFETs, MIC4426/7/8 drivers are suitable for driving other loads (capacitive, resistive, or inductive) that require low-impedance, high peak current, and fast switching time. Other applications include driving heavily loaded clock lines, coaxial cables, or piezoelectric transducers. The only load limitation is that total driver power dissipation must not exceed the limits of the package.

See MIC4126/4127/4128 for high power and narrow pulse applications.

Package Types



MIC4426/7/8

Functional Block Diagram

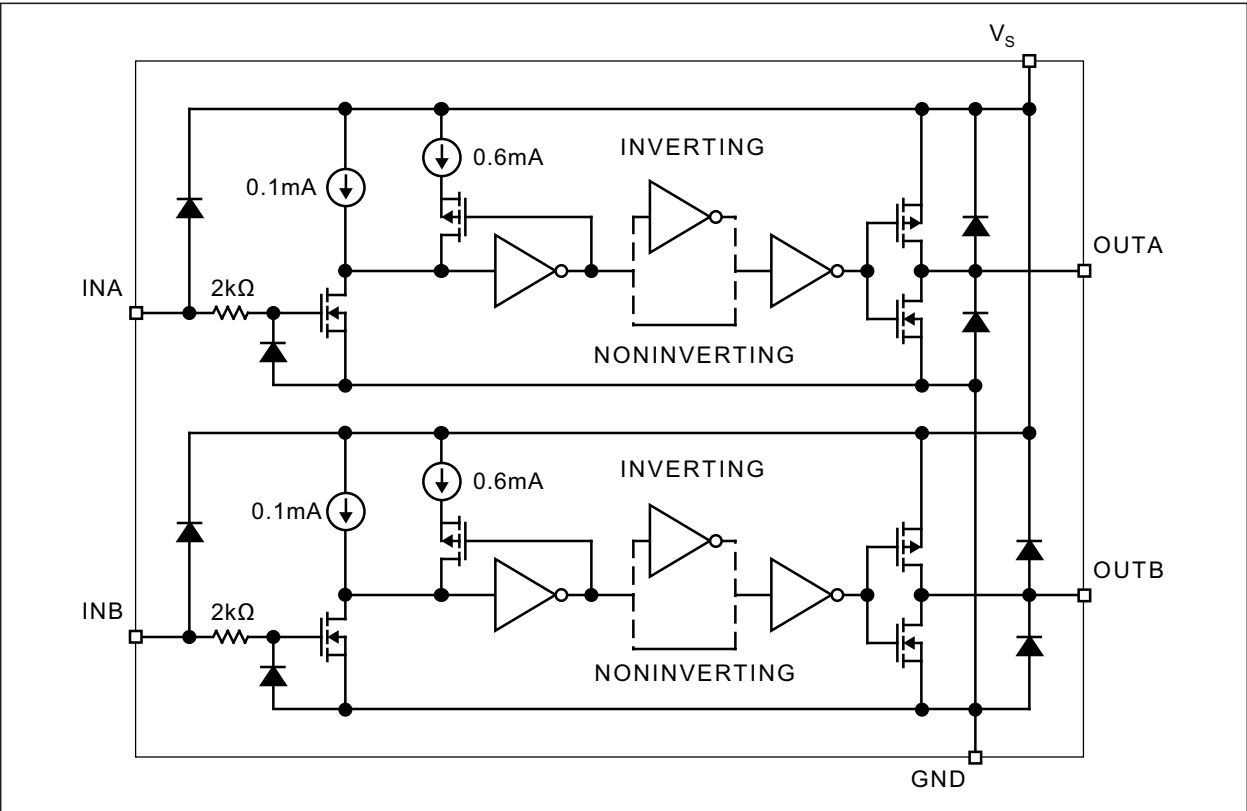

1.0 ELECTRICAL CHARACTERISTICS

Absolute Maximum Ratings †

Supply Voltage (V_S)	+22V
Input Voltage (V_{IN})	$V_S + 0.3V$ to GND – 5V
ESD Rating	(Note 1)

Operating Ratings ††

Supply Voltage (V_S)	+4.5V to +18V
--------------------------------	---------------

† **Notice:** Stresses above those listed under “Absolute Maximum Ratings” may cause permanent damage to the device. This is a stress rating only and functional operation of the device at those or any other conditions above those indicated in the operational sections of this specification is not intended. Exposure to maximum rating conditions for extended periods may affect device reliability.

†† **Notice:** The device is not guaranteed to function outside its operating ratings.

Note 1: Devices are ESD sensitive. Handling precautions are recommended.

ELECTRICAL CHARACTERISTICS

Electrical Characteristics: $4.5V \leq V_S \leq 18V$; $T_A = +25^\circ C$, **bold** values valid for full specified temperature range; unless noted. [Note 1](#)

Parameter	Sym.	Min.	Typ.	Max.	Units	Conditions
Input						
Logic 1 Input Voltage	V_{IH}	2.4	1.4	—	V	—
		2.4	1.5	—		
Logic 0 Input Voltage	V_{IL}	—	1.1	0.8	V	—
		—	1.0	0.8		
Input Current	I_{IN}	-1	—	1	μA	$0V \leq V_{IN} \leq V_S$
Output						
High Output Voltage	V_{OH}	$V_S -$ 0.025	—	—	V	—
Low Output Voltage	V_{OL}	—	—	0.025	V	—
Output Resistance	R_O	—	6	10	Ω	$I_{OUT} = 10\text{ mA}, V_S = 18V$
		—	8	12		
Peak Output Current	I_{PK}	—	1.5	—	A	—
Latch-Up Protection	I	>500	—	—	mA	Withstand Reverse Current
Switching Time						
Rise Time	t_r	—	18	30	ns	Test Figure 1-1
		—	20	40		—
Fall Time	t_f	—	15	20	ns	Test Figure 1-1
		—	29	40		—
Delay Time	t_{D1}	—	17	30	ns	Test Figure 1-1
		—	19	40		—
Delay Time	t_{D2}	—	23	50	ns	Test Figure 1-1
		—	27	60		—

Note 1: Specification for packaged product only.

MIC4426/7/8

ELECTRICAL CHARACTERISTICS (CONTINUED)

Electrical Characteristics: $4.5V \leq V_S \leq 18V$; $T_A = +25^\circ C$, **bold** values valid for full specified temperature range; unless noted. [Note 1](#)

Parameter	Sym.	Min.	Typ.	Max.	Units	Conditions
Pulse Width	t_{PW}	400	—	—	ns	Test Figure 1-1
Power Supply						
Power Supply Current	I_S	0.6	1.4	4.5	mA	$V_{INA} = V_{INB} = 3.0V$
		—	1.5	8		—
Power Supply Current	I_S	—	0.18	0.4	mA	$V_{INA} = V_{INB} = 0V$
		—	0.19	0.6		—

Note 1: Specification for packaged product only.

TEMPERATURE SPECIFICATIONS

Parameters	Sym.	Min.	Typ.	Max.	Units	Conditions
Temperature Ranges						
Maximum Junction Temperature	T_J	—	—	+150	$^\circ C$	—
Storage Temperature Range	T_S	-65	—	+150	$^\circ C$	—
Lead Temperature	—	—	—	+300	$^\circ C$	10 sec.
Junction Operating Temperature Range	T_J	0	—	+70	$^\circ C$	Z option
Junction Operating Temperature Range	T_J	-40	—	+85	$^\circ C$	Y option
Package Thermal Resistances						
Thermal Resistance, PDIP 8-Ld	θ_{JA}	—	130	—	$^\circ C/W$	—
Thermal Resistance, PDIP 8-Ld	θ_{JC}	—	42	—	$^\circ C/W$	—
Thermal Resistance, SOIC 8-Ld	θ_{JA}	—	120	—	$^\circ C/W$	—
Thermal Resistance, SOIC 8-Ld	θ_{JC}	—	75	—	$^\circ C/W$	—
Thermal Resistance, MSOP 8-Ld	θ_{JA}	—	250	—	$^\circ C/W$	—

Note 1: The maximum allowable power dissipation is a function of ambient temperature, the maximum allowable junction temperature and the thermal resistance from junction to air (i.e., T_A , T_J , θ_{JA}). Exceeding the maximum allowable power dissipation will cause the device operating junction temperature to exceed the maximum +125 $^\circ C$ rating. Sustained junction temperatures above +125 $^\circ C$ can impact the device reliability.

Test Circuits

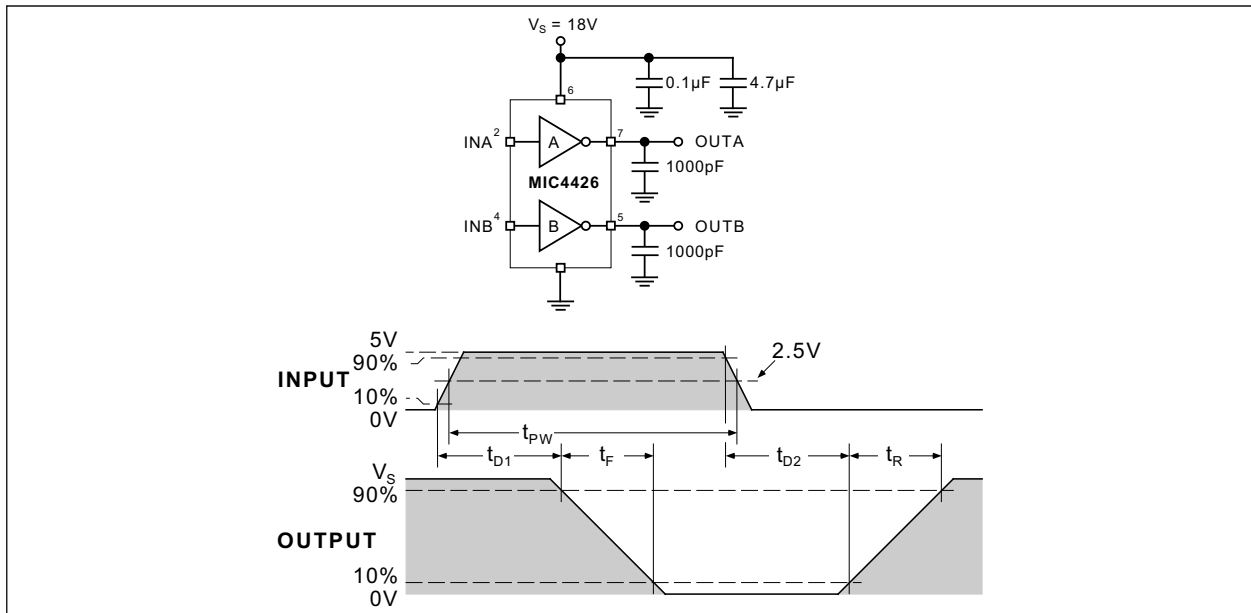

FIGURE 1-1: Inverting Driver Switching Time.

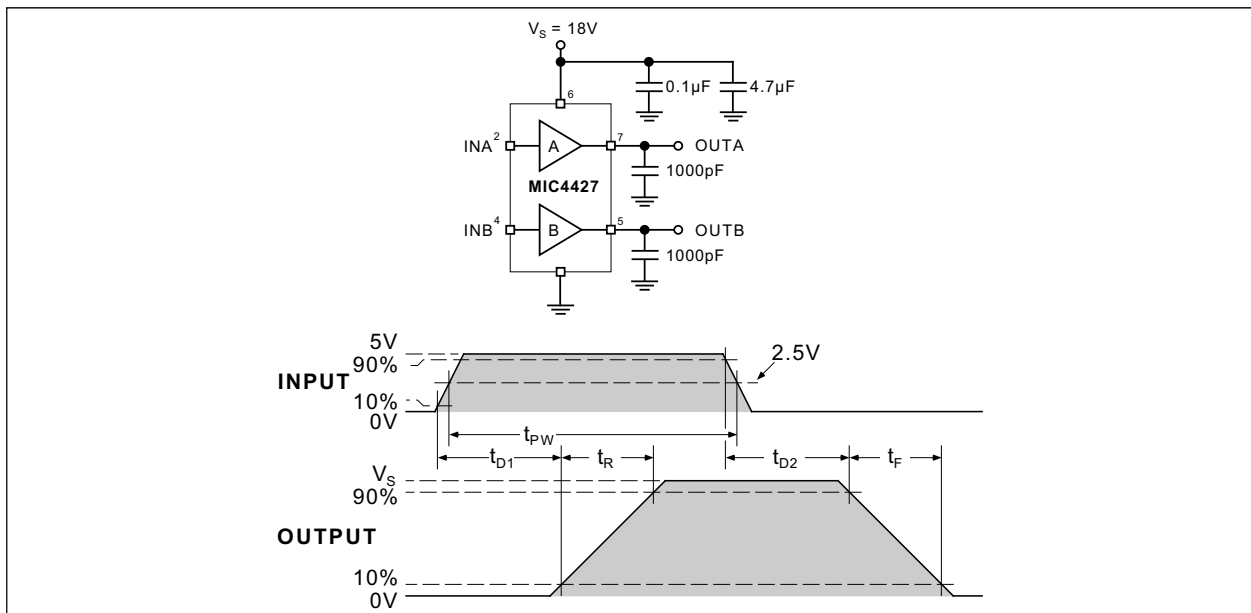

FIGURE 1-2: Non-Inverting Driver Switching Time.

MIC4426/7/8

2.0 TYPICAL PERFORMANCE CURVES

Note: The graphs and tables provided following this note are a statistical summary based on a limited number of samples and are provided for informational purposes only. The performance characteristics listed herein are not tested or guaranteed. In some graphs or tables, the data presented may be outside the specified operating range (e.g., outside specified power supply range) and therefore outside the warranted range.

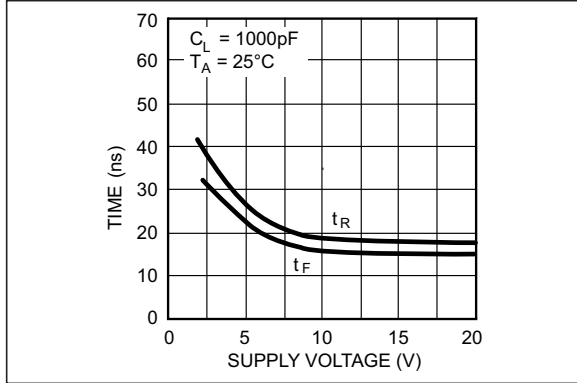

FIGURE 2-1: Rise and Fall Time vs. Supply Voltage.

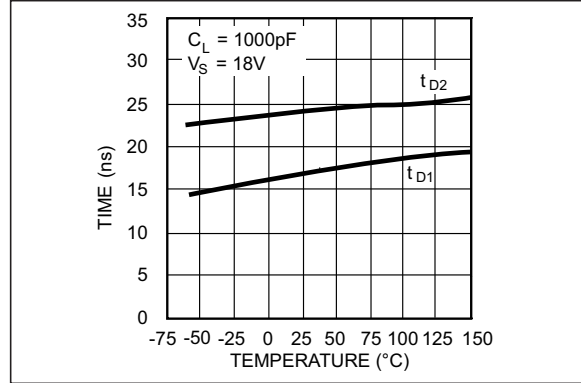

FIGURE 2-4: Delay Time vs. Temperature.

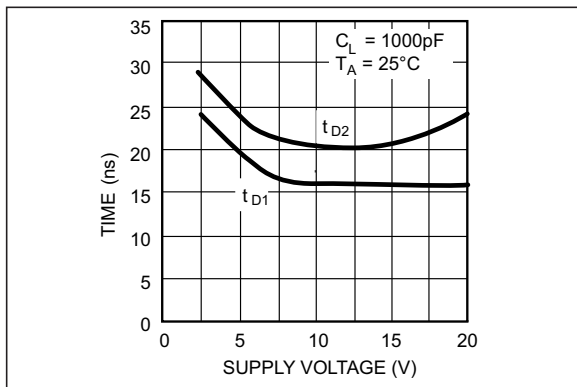

FIGURE 2-2: Delay Time vs. Supply Voltage.

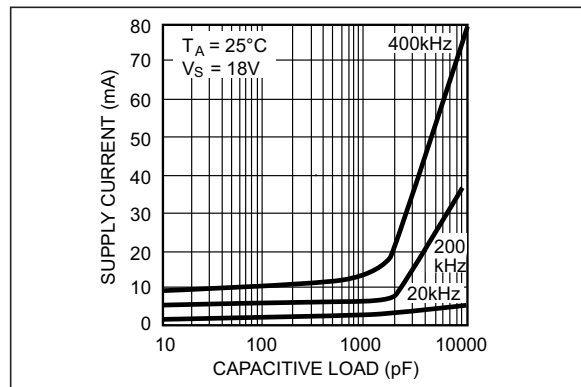

FIGURE 2-5: Supply Current vs. Capacitive Load.

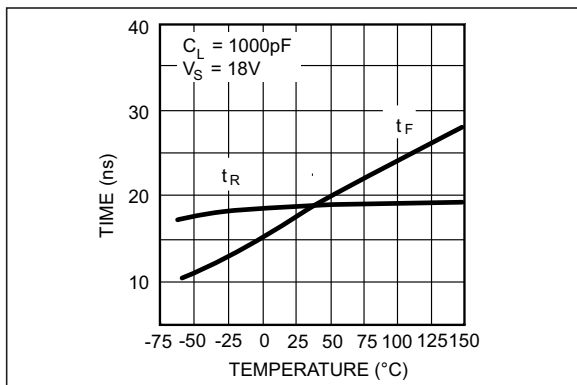

FIGURE 2-3: Rise and Fall Time vs. Temperature.

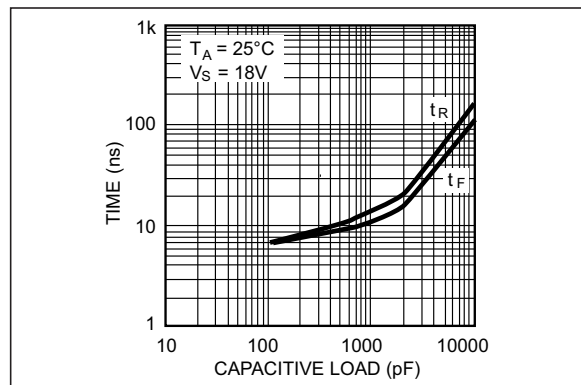

FIGURE 2-6: Rise and Fall Time vs. Capacitive Load.



FIGURE 2-7: Supply Current vs. Frequency.



FIGURE 2-10: Quiescent Power Supply Current vs. Supply Voltage.



FIGURE 2-8: High Output vs. Current.



FIGURE 2-11: Quiescent Power Supply Current vs. Supply Voltage.



FIGURE 2-9: Low Output vs. Current.



FIGURE 2-12: Package Power Dissipation.

MIC4426/7/8

3.0 PIN DESCRIPTIONS

The descriptions of the pins are listed in [Table 3-1](#).

TABLE 3-1: PIN FUNCTION TABLE

Pin Number	Pin Name	Description
1, 8	NC	Not internally connected.
2	INA	Control Input A: TTL/CMOS compatible logic input.
3	GND	Ground.
4	INB	Control Input B: TTL/CMOS compatible logic input.
5	OUTB	Output B: CMOS totem-pole output.
6	VS	Supply Input: +4.5V to +18V.
7	OUTA	Output A: CMOS totem-pole output.

4.0 APPLICATION INFORMATION

4.1 Supply Bypassing

Large currents are required to charge and discharge large capacitive loads quickly. For example, changing a 1000 pF load by 16V in 25 ns requires 0.8A from the supply input.

To guarantee low supply impedance over a wide frequency range, parallel capacitors are recommended for power supply bypassing. Low-inductance ceramic MLC capacitors with short lead lengths (< 0.5") should be used. A 1.0 μF film capacitor in parallel with one or two 0.1 μF ceramic MLC capacitors normally provides adequate bypassing.

4.2 Grounding

When using the inverting drivers in the MIC4426 or MIC4428, individual ground returns for the input and output circuits or a ground plane are recommended for optimum switching speed. The voltage drop that occurs between the driver's ground and the input signal ground, during normal high-current switching, will behave as negative feedback and degrade switching speed.

4.3 Control Input

Unused driver inputs must be connected to logic high (which can be VS) or ground. For the lowest quiescent current (<500 μA), connect unused inputs to ground. A logic high signal will cause the driver to draw up to 9 mA.

The drivers are designed with 100 mV of control input hysteresis. This provides clean transitions and minimizes output stage current spikes when changing states. The control input voltage threshold is approximately 1.5V. The control input recognizes 1.5V up to VS as a logic high and draws less than 1 μA within this range.

The MIC4426/7/8 drives the TL494, SG1526/7, MIC38C42, TSC170, and similar switch-mode power supply integrated circuits.

4.4 Power Dissipation

Power dissipation should be calculated to make sure that the driver is not operated beyond its thermal ratings. Quiescent power dissipation is negligible. A practical value for total power dissipation is the sum of the dissipation caused by the load and the transition power dissipation ($P_L + P_T$).

4.5 Load Dissipation

Power dissipation caused by continuous load current (when driving a resistive load) through the driver's output resistance is:

EQUATION 4-1:

$$P_L = I_L^2 \times R_O$$

For capacitive loads, the dissipation in the driver is:

EQUATION 4-2:

$$P_L = f \times C_L \times V_S^2$$

4.6 Power Dissipation

In applications switching at a high frequency, transition power dissipation can be significant. This occurs during switching transitions when the P-channel and N-channel output FETs are both conducting for the brief moment when one is turning on and the other is turning off.

EQUATION 4-3:

$$P_T = 2 \times f \times V_S \times Q$$

Charge (Q) is read from the following graph:

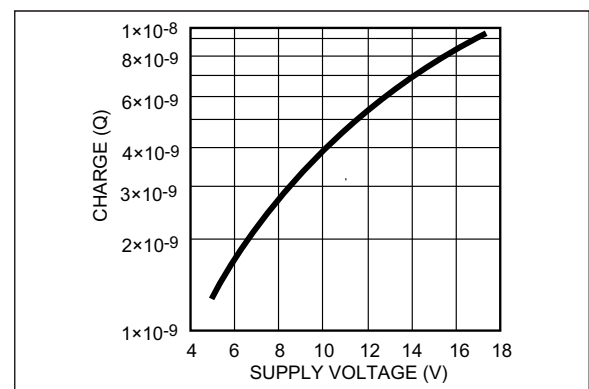

FIGURE 4-1: Crossover Energy Loss per Transition.

MIC4426/7/8

5.0 PACKAGING INFORMATION

5.1 Package Marking Information

8-Lead SOIC*



Example

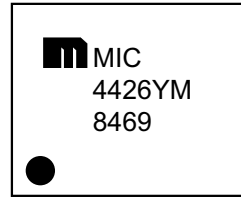

8-Lead PDIP*



Example

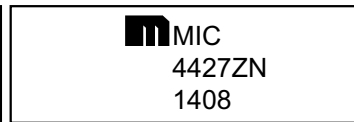

8-Lead MSOP*



Example

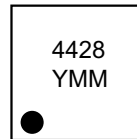

Legend:	XX...X	Product code or customer-specific information
	Y	Year code (last digit of calendar year)
	YY	Year code (last 2 digits of calendar year)
	WW	Week code (week of January 1 is week '01')
	NNN	Alphanumeric traceability code
	(e3)	Pb-free JEDEC® designator for Matte Tin (Sn)
	*	This package is Pb-free. The Pb-free JEDEC designator (e3) can be found on the outer packaging for this package.
	•, ▲, ▼	Pin one index is identified by a dot, delta up, or delta down (triangle mark).
Note:	In the event the full Microchip part number cannot be marked on one line, it will be carried over to the next line, thus limiting the number of available characters for customer-specific information. Package may or may not include the corporate logo.	
	Underbar () and/or Overbar () symbol may not be to scale.	

8-Lead SOICN Package Outline & Recommended Land Pattern

TITLE

8 LEAD SOICN PACKAGE OUTLINE & RECOMMENDED LAND PATTERN

DRAWING #	SOICN-8LD-PL-1	UNIT	INCH [MM]
-----------	----------------	------	-----------



TOP VIEW



BOTTOM VIEW

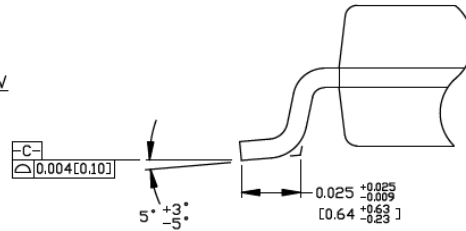

DETAIL "A"



END VIEW



RECOMMENDED LAND PATTERN

NOTES:

1. DIMENSIONS ARE IN INCHES[MM].
2. CONTROLLING DIMENSION: INCHES.
3. DIMENSION DOES NOT INCLUDE MOLD FLASH OR PROTRUSIONS, EITHER OF WHICH SHALL NOT EXCEED 0.010[0.25] PER SIDE.

Note: For the most current package drawings, please see the Microchip Packaging Specification located at <http://www.microchip.com/packaging>.

MIC4426/7/8

8-Lead PDIP Package Outline and Recommended Land Pattern

TITLE

8 LEAD PDIP PACKAGE OUTLINE & RECOMMENDED LAND PATTERN

DRAWING #	PDIP-8LD-PL-1	UNIT	INCH
Lead Frame	Copper	Lead Finish	Matte Tin



TOP VIEW



END VIEW

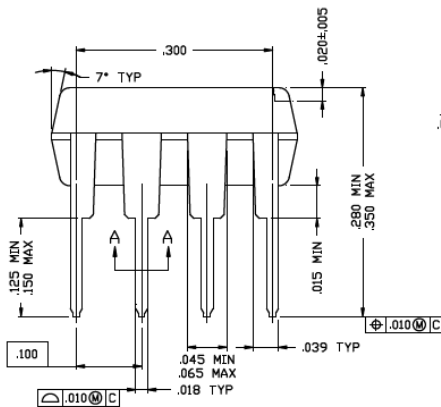

SIDE VIEW



SECTION A-A

Note: For the most current package drawings, please see the Microchip Packaging Specification located at <http://www.microchip.com/packaging>.

8-Lead MSOP Package Outline and Recommended Land Pattern

TITLE

8 LEAD MSOP PACKAGE OUTLINE & RECOMMENDED LAND PATTERN

DRAWING #	MSOP-8LD-PL-1	UNIT	INCH [MM]
-----------	---------------	------	-----------

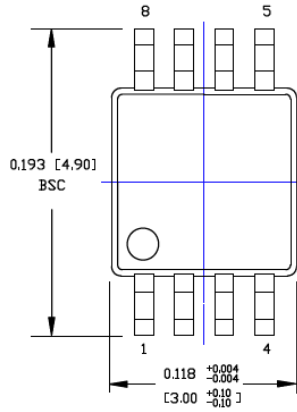

TOP VIEW



BOTTOM VIEW



DETAIL A

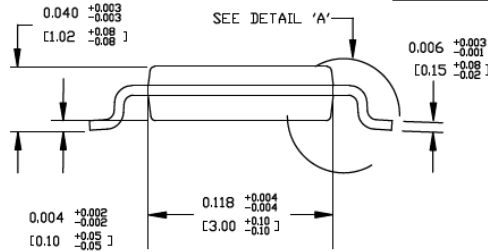

SIDE VIEW

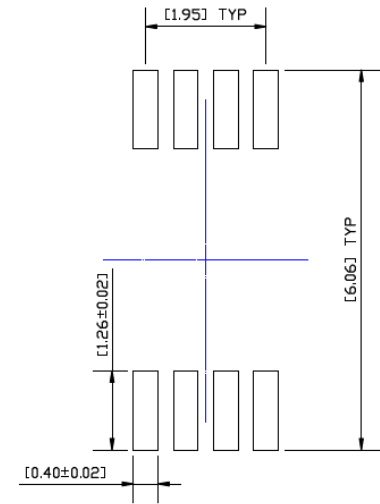

RECOMMENDED LAND PATTERN

NOTES:

1. DIMENSIONS ARE IN INCHES [MM].
2. CONTROLLING DIMENSION: MM.
3. DIMENSION DOES NOT INCLUDE MOLD FLASH OR PROTRUSIONS, EITHER OF WHICH SHALL NOT EXCEED 0.008 [0.20] PER SIDE.

Note: For the most current package drawings, please see the Microchip Packaging Specification located at <http://www.microchip.com/packaging>.

MIC4426/7/8

NOTES:

APPENDIX A: REVISION HISTORY

Revision A (May 2019)

- Converted Micrel document MIC4426/7/8 to Microchip data sheet template DS20006202A.
- Minor grammatical text changes throughout.

MIC4426/7/8

NOTES:

PRODUCT IDENTIFICATION SYSTEM

To order or obtain information, e.g., on pricing or delivery, contact your local Microchip representative or sales office.

Device	X	XX	-XX
Part No.	Junction Temp. Range	Package	Media Type
Device:	MIC4426:	Dual Inverting, Dual 1.5A-Peak Low-Side MOSFET Driver	
	MIC4427:	Dual Non-Inverting, Dual 1.5A-Peak Low-Side MOSFET Driver	
	MIC4428:	Inverting and Non-Inverting, Dual 1.5A-Peak Low-Side MOSFET Driver	
Junction Temperature Range:	Y =	-40°C to +85°C, RoHS-Compliant	
	Z =	0°C to +70°C, RoHS-Compliant	
Package:	N =	8-Lead PDIP	
	M =	8-Lead SOIC	
	MM =	8-Lead MSOP	
Media Type:	<blank>=	95/Tube (SOIC only)	
	<blank>=	100/Tube (MSOP only)	
	<blank>=	50/Tube (PDIP only)	
	TR =	2,500/Reel (SOIC only)	

Examples:		
a) MIC4426: Dual Inverting, Dual 1.5A-Peak Low-Side MOSFET Driver, -40°C to +85°C Temp. Range		
MIC4426YM	8-Lead SOIC	95/Tube
MIC4426YM-TR	8-Lead SOIC	2,500/Reel
MIC4426YN	8-Lead PDIP	50/Tube
MIC4426YMM	8-Lead MSOP	100/Tube
MIC4426YMM-TR	8-Lead MSOP	2,500/Reel
b) MIC4426: Dual Inverting, Dual 1.5A-Peak Low-Side MOSFET Driver, 0°C to +70°C Temp. Range		
MIC4426ZN	8-Lead PDIP	50/Tube
MIC4426ZM	8-Lead SOIC	95/Tube
MIC4426ZM-TR	8-Lead SOIC	2,500/Reel
c) MIC4427: Dual Non-Inverting, Dual 1.5A-Peak Low-Side MOSFET Driver, -40°C to +85°C Temp. Range		
MIC4427YM	8-Lead SOIC	95/Tube
MIC4427YM-TR	8-Lead SOIC	2,500/Reel
MIC4427YN	8-Lead PDIP	50/Tube
MIC4427YMM	8-Lead MSOP	100/Tube
MIC4427YMM-TR	8-Lead MSOP	2,500/Reel
d) MIC4427: Dual Non-Inverting, Dual 1.5A-Peak Low-Side MOSFET Driver, 0°C to +70°C Temp. Range		
MIC4427ZN	8-Lead PDIP	50/Tube
MIC4427ZM	8-Lead SOIC	95/Tube
MIC4427ZM-TR	8-Lead SOIC	2,500/Reel
e) MIC4428: Inverting + Non-Inverting, Dual 1.5A-Peak Low-Side MOSFET Driver, -40°C to +85°C Temp. Range		
MIC4428YM	8-Lead SOIC	95/Tube
MIC4428YM-TR	8-Lead SOIC	2,500/Reel
MIC4428YN	8-Lead PDIP	50/Tube
MIC4428YMM	8-Lead MSOP	100/Tube
MIC4428YMM-TR	8-Lead MSOP	2,500/Reel
f) MIC4428: Inverting + Non-Inverting, Dual 1.5A-Peak Low-Side MOSFET Driver, 0°C to +70°C Temp. Range		
MIC4428ZN	8-Lead PDIP	50/Tube
MIC4428ZM	8-Lead SOIC	95/Tube
MIC4428ZM-TR	8-Lead SOIC	2,500/Reel
Note 1:	Tape and Reel identifier only appears in the catalog part number description. This identifier is used for ordering purposes and is not printed on the device package. Check with your Microchip Sales Office for package availability with the Tape and Reel option.	

MIC4426/7/8

NOTES:

Note the following details of the code protection feature on Microchip devices:

- Microchip products meet the specification contained in their particular Microchip Data Sheet.
- Microchip believes that its family of products is one of the most secure families of its kind on the market today, when used in the intended manner and under normal conditions.
- There are dishonest and possibly illegal methods used to breach the code protection feature. All of these methods, to our knowledge, require using the Microchip products in a manner outside the operating specifications contained in Microchip's Data Sheets. Most likely, the person doing so is engaged in theft of intellectual property.
- Microchip is willing to work with the customer who is concerned about the integrity of their code.
- Neither Microchip nor any other semiconductor manufacturer can guarantee the security of their code. Code protection does not mean that we are guaranteeing the product as “unbreakable.”

Code protection is constantly evolving. We at Microchip are committed to continuously improving the code protection features of our products. Attempts to break Microchip's code protection feature may be a violation of the Digital Millennium Copyright Act. If such acts allow unauthorized access to your software or other copyrighted work, you may have a right to sue for relief under that Act.

Information contained in this publication regarding device applications and the like is provided only for your convenience and may be superseded by updates. It is your responsibility to ensure that your application meets with your specifications. MICROCHIP MAKES NO REPRESENTATIONS OR WARRANTIES OF ANY KIND WHETHER EXPRESS OR IMPLIED, WRITTEN OR ORAL, STATUTORY OR OTHERWISE, RELATED TO THE INFORMATION, INCLUDING BUT NOT LIMITED TO ITS CONDITION, QUALITY, PERFORMANCE, MERCHANTABILITY OR FITNESS FOR PURPOSE. Microchip disclaims all liability arising from this information and its use. Use of Microchip devices in life support and/or safety applications is entirely at the buyer's risk, and the buyer agrees to defend, indemnify and hold harmless Microchip from any and all damages, claims, suits, or expenses resulting from such use. No licenses are conveyed, implicitly or otherwise, under any Microchip intellectual property rights unless otherwise stated.

Microchip received ISO/TS-16949:2009 certification for its worldwide headquarters, design and wafer fabrication facilities in Chandler and Tempe, Arizona; Gresham, Oregon and design centers in California and India. The Company's quality system processes and procedures are for its PIC® MCUs and dsPIC® DSCs, KEELoq® code hopping devices, Serial EEPROMs, microperipherals, nonvolatile memory and analog products. In addition, Microchip's quality system for the design and manufacture of development systems is ISO 9001:2000 certified.

**QUALITY MANAGEMENT SYSTEM
CERTIFIED BY DNV
= ISO/TS 16949 =**

Trademarks

The Microchip name and logo, the Microchip logo, AnyRate, AVR, AVR logo, AVR Freaks, BitCloud, chipKIT, chipKIT logo, CryptoMemory, CryptoRF, dsPIC, FlashFlex, flexPWR, Helder, JukeBlox, KeeLoq, Kleer, LANCheck, LINK MD, maXStylus, maXTouch, MediaLB, megaAVR, MOST, MOST logo, MPLAB, OptoLyzer, PIC, picoPower, PICSTART, PIC32 logo, Prochip Designer, QTouch, SAM-BA, SpyNIC, SST, SST Logo, SuperFlash, tinyAVR, UNI/O, and XMEGA are registered trademarks of Microchip Technology Incorporated in the U.S.A. and other countries.

ClockWorks, The Embedded Control Solutions Company, EtherSynch, Hyper Speed Control, HyperLight Load, IntellIMOS, mTouch, Precision Edge, and Quiet-Wire are registered trademarks of Microchip Technology Incorporated in the U.S.A.

Adjacent Key Suppression, AKS, Analog-for-the-Digital Age, Any Capacitor, AnyIn, AnyOut, BodyCom, CodeGuard, CryptoAuthentication, CryptoAutomotive, CryptoCompanion, CryptoController, dsPICDEM, dsPICDEM.net, Dynamic Average Matching, DAM, ECAN, EtherGREEN, In-Circuit Serial Programming, ICSP, INICnet, Inter-Chip Connectivity, JitterBlocker, KleerNet, KleerNet logo, memBrain, Mindi, MiWi, motorBench, MPASM, MPF, MPLAB Certified logo, MPLIB, MPLINK, MultiTRAK, NetDetach, Omniscient Code Generation, PICDEM, PICDEM.net, PICKit, PICtail, PowerSmart, PureSilicon, QMatrix, REAL ICE, Ripple Blocker, SAM-ICE, Serial Quad I/O, SMART-I.S., SQI, SuperSwitcher, SuperSwitcher II, Total Endurance, TSHARC, USBCheck, VariSense, ViewSpan, WiperLock, Wireless DNA, and ZENA are trademarks of Microchip Technology Incorporated in the U.S.A. and other countries.

SQTP is a service mark of Microchip Technology Incorporated in the U.S.A.

Silicon Storage Technology is a registered trademark of Microchip Technology Inc. in other countries.

GestIC is a registered trademark of Microchip Technology Germany II GmbH & Co. KG, a subsidiary of Microchip Technology Inc., in other countries.

All other trademarks mentioned herein are property of their respective companies.

© 2019, Microchip Technology Incorporated, All Rights Reserved.
ISBN: 978-1-5224-4570-8



MICROCHIP

Worldwide Sales and Service

AMERICAS

Corporate Office
2355 West Chandler Blvd.
Chandler, AZ 85224-6199
Tel: 480-792-7200
Fax: 480-792-7277
Technical Support:
<http://www.microchip.com/support>
Web Address:
www.microchip.com

Atlanta

Duluth, GA
Tel: 678-957-9614
Fax: 678-957-1455

Austin, TX

Tel: 512-257-3370

Boston

Westborough, MA
Tel: 774-760-0087
Fax: 774-760-0088

Chicago

Itasca, IL
Tel: 630-285-0071
Fax: 630-285-0075

Dallas

Addison, TX
Tel: 972-818-7423
Fax: 972-818-2924

Detroit

Novi, MI
Tel: 248-848-4000

Houston, TX

Tel: 281-894-5983

Indianapolis

Noblesville, IN
Tel: 317-773-8323
Fax: 317-773-5453
Tel: 317-536-2380

Los Angeles

Mission Viejo, CA
Tel: 949-462-9523
Fax: 949-462-9608
Tel: 951-273-7800

Raleigh, NC

Tel: 919-844-7510

New York, NY

Tel: 631-435-6000

San Jose, CA

Tel: 408-735-9110
Tel: 408-436-4270

Canada - Toronto

Tel: 905-695-1980
Fax: 905-695-2078

ASIA/PACIFIC

Australia - Sydney
Tel: 61-2-9868-6733

China - Beijing
Tel: 86-10-8569-7000

China - Chengdu
Tel: 86-28-8665-5511

China - Chongqing
Tel: 86-23-8980-9588

China - Dongguan
Tel: 86-769-8702-9880

China - Guangzhou
Tel: 86-20-8755-8029

China - Hangzhou
Tel: 86-571-8792-8115

China - Hong Kong SAR
Tel: 852-2943-5100

China - Nanjing
Tel: 86-25-8473-2460

China - Qingdao
Tel: 86-532-8502-7355

China - Shanghai
Tel: 86-21-3326-8000

China - Shenyang
Tel: 86-24-2334-2829

China - Shenzhen
Tel: 86-755-8864-2200

China - Suzhou
Tel: 86-186-6233-1526

China - Wuhan
Tel: 86-27-5980-5300

China - Xian
Tel: 86-29-8833-7252

China - Xiamen
Tel: 86-592-2388138

China - Zhuhai
Tel: 86-756-3210040

ASIA/PACIFIC

India - Bangalore
Tel: 91-80-3090-4444

India - New Delhi
Tel: 91-11-4160-8631

India - Pune
Tel: 91-20-4121-0141

Japan - Osaka
Tel: 81-6-6152-7160

Japan - Tokyo
Tel: 81-3-6880-3770

Korea - Daegu
Tel: 82-53-744-4301

Korea - Seoul
Tel: 82-2-554-7200

Malaysia - Kuala Lumpur
Tel: 60-3-7651-7906

Malaysia - Penang
Tel: 60-4-227-8870

Philippines - Manila
Tel: 63-2-634-9065

Singapore
Tel: 65-6334-8870

Taiwan - Hsin Chu
Tel: 886-3-577-8366

Taiwan - Kaohsiung
Tel: 886-7-213-7830

Taiwan - Taipei
Tel: 886-2-2508-8600

Thailand - Bangkok
Tel: 66-2-694-1351

Vietnam - Ho Chi Minh
Tel: 84-28-5448-2100

EUROPE

Austria - Wels
Tel: 43-7242-2244-39
Fax: 43-7242-2244-393

Denmark - Copenhagen
Tel: 45-4450-2828
Fax: 45-4485-2829

Finland - Espoo
Tel: 358-9-4520-820

France - Paris
Tel: 33-1-69-53-63-20
Fax: 33-1-69-30-90-79

Germany - Garching
Tel: 49-8931-9700

Germany - Haan
Tel: 49-2129-3766400

Germany - Heilbronn
Tel: 49-7131-72400

Germany - Karlsruhe
Tel: 49-721-625370

Germany - Munich
Tel: 49-89-627-144-0
Fax: 49-89-627-144-44

Germany - Rosenheim
Tel: 49-8031-354-560

Israel - Ra'anana
Tel: 972-9-744-7705

Italy - Milan
Tel: 39-0331-742611
Fax: 39-0331-466781

Italy - Padova
Tel: 39-049-7625286

Netherlands - Drunen
Tel: 31-416-690399
Fax: 31-416-690340

Norway - Trondheim
Tel: 47-7288-4388

Poland - Warsaw
Tel: 48-22-3325737

Romania - Bucharest
Tel: 40-21-407-87-50

Spain - Madrid
Tel: 34-91-708-08-90
Fax: 34-91-708-08-91

Sweden - Gothenberg
Tel: 46-31-704-60-40

Sweden - Stockholm
Tel: 46-8-5090-4654

UK - Wokingham
Tel: 44-118-921-5800
Fax: 44-118-921-5820

Looking for pricing, stock, or lifecycle information?

Click below to explore more details on WIN SOURCE:

- ⊖ [View MIC4427YMM on WIN SOURCE](#)
- ⊖ [Microchip Technology Information](#)

Optimize Your Supply Chain with WIN SOURCE Solutions

- ✓ Global Sourcing Solution
- ✓ Obsolete Management
- ✓ Cost Control Management
- ✓ Shortage Management
- ✓ Alternative Solution
- ✓ Excess Inventory Management