



MIC2774

Dual Micro-Power Low Voltage Supervisor

General Description

The MIC2774 is a dual power supply supervisor that provides undervoltage monitoring, manual reset capability, and power-on reset generation in a compact 5-pin SOT-23 package. Features include two undervoltage detectors, one fixed and one adjustable, and a choice of reset outputs. One undervoltage detector compares V_{DD} against a fixed threshold. Ten factory-programmed thresholds are available. The second, user-adjustable input is compared against a 300mV reference. This low reference voltage allows for the monitoring of voltages lower than those supported by previous supervisor ICs.

The reset outputs are asserted at power-on and at any time either voltage drops below the programmed threshold voltage and remains asserted for 140ms (min.) after they subsequently rise back above the threshold boundaries. Manual reset functionality can be provided by a switch connected between ground and the /MR input. A wide choice of voltage thresholds provides for a variety of supply voltages and tolerances. Hysteresis is included to prevent chattering due to noise. Typical supply current is a low 3.5 μ A.

Datasheets and support documentation are available on Micrel's website at: www.micrel.com.

Features

- Monitors two independent power supplies for undervoltage conditions
- One fixed and one user-adjustable input
- Choice of ten factory-programmed thresholds
- Adjustable input can monitor supplies as low as 0.3V
- Generates 140ms (min.) power-on reset pulse
- Manual reset input
- Choice of active-high, active-low, or open-drain active-low reset outputs
- Inputs may be pulled above V_{DD} (7V abs. max.)
- /RST output valid down to 1.2V
- Ultra-low supply current, 3.5 μ A typical
- Rejects brief input transients
- IttyBitty™ 5-pin SOT-23 package
- Pin-compatible upgrade for MAX6306/09/12

Applications

- Monitoring processor ASIC or FPGA core and I/O voltages
- PDAs, hand-held PCs
- Embedded controllers
- Telecommunications systems
- Power supplies
- Wireless/cellular systems
- Networking hardware

Typical Application

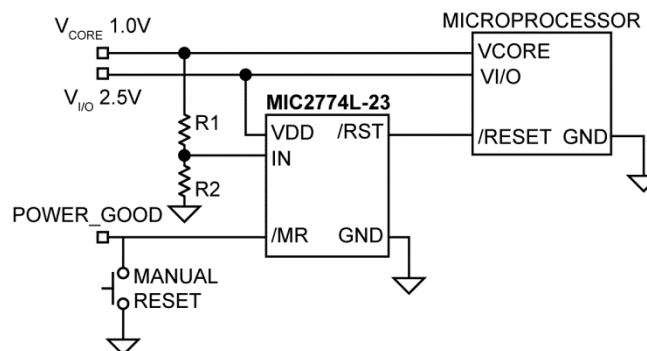

IttyBitty is a trademark of Micrel, Inc.

Micrel Inc. • 2180 Fortune Drive • San Jose, CA 95131 • USA • tel +1 (408) 944-0800 • fax + 1 (408) 474-1000 • <http://www.micrel.com>

Ordering Information

Part Number ^(1,2)	Marking ^(1,3)	Reset Output	Junction Temperature Range	Package ⁽⁴⁾
MIC2774N-XXYM5	<u>UG</u> XX	Open-Drain. Active-Low (/RST)	-40°C to +85°C	SOT-23-5
MIC2774H-XXYM5	<u>UH</u> XX	Active-High. Complementary (RST)	-40°C to +85°C	SOT-23-5
MIC2774L-XXYM5	<u>UL</u> XX	Active-Low. Complementary (/RST)	-40°C to +85°C	SOT-23-5

Note:

1. XX = voltage code, see table below.
2. Order entry part number, add " TR". Example: MIC2774N-22YM5 TR.
3. Underbar symbol () may not be to scale.
4. Standard reel SOT-23: Reel diameter is 7 inches, hub diameter is 2 inches, width is 8mm.

Standard Voltage Options⁽⁵⁾

Voltage Code	Typical Application (V _{DD})	Nominal Threshold Voltage (V _{TH})
46	5.0V ±5%	4.68V
44	5.0V ±10%	4.43V
31	3.3V ±5%	3.09V
29	3.3V ±10%	2.93V
28	3.0V ±5%	2.81V
26	2.85V ±5%	2.67V
25	2.7V ±5%	2.53V
23	2.5V ±5%	2.34V
22	2.4V ±5%	2.25V
17	1.8V ±5%	1.69V

Note:

5. There are ten standard versions available with an order increment of 3,000 pieces. Samples of standard versions are normally available from stock. Contact factory for information on non-standard versions. Available in tape-and-reel only.

Part Number Convention



Pin Configuration



SOT-23-5 (M5)
"H" Version



SOT-23-5 (M5)
"L" and "N" Version

Pin Description

Pin Number MIC2774H	Pin Number MIC2774L MIC2774N	Pin Name	Pin Function
1		RST	Digital (Output): Asserted high whenever V_{IN} or V_{DD} falls below the threshold voltage. It will remain asserted for no less than 140ms after V_{IN} and V_{DD} return above the threshold limits.
	1	/RST	Digital (Output): Asserted low whenever V_{IN} or V_{DD} falls below the threshold voltage. It will remain asserted for no less than 140ms after V_{IN} and V_{DD} return above the threshold limits. (Open-drain for "N" version, requires an external pull-up resistor).
2	2	GND	Ground
3	3	/MR	Digital (Input): Driving this pin low initiates immediate and unconditional reset. Assuming V_{IN} and V_{DD} are above the thresholds when /MR is released (returns high), the reset output will be de-asserted no less than 140ms later. /MR may be driven by a logic signal or a mechanical switch. /MR has an internal pull-up to V_{DD} and may be left open if unused.
4	4	IN	Analog (Input): The voltage on this pin is compared to the internal 300mV reference. An undervoltage condition will trigger a reset sequence.
5	5	VDD	Analog (Input): Power supply input for internal circuitry and input to the fixed voltage monitor. The voltage on this pin is compared against the internal reference. An undervoltage condition will trigger a reset sequence.

Absolute Maximum Ratings⁽⁶⁾

Supply Voltage (V_{DD})	-0.3V to +7.0V
Input Voltages (V_{IN} , V_{MR})	-0.3V to +7.0V
Output Voltages (V_{RST} , V_{RST})	-0.3V to +7.0V
RST, (/RST) Current	20mA
Storage Temperature (T_s)	-65°C to +150°C
ESD Rating ⁽⁸⁾	1.5kV

Operating Ratings⁽⁷⁾

Supply Voltage (V_{DD})	+1.5V to +5.5V
Input Voltages (V_{IN} , V_{MR})	-0.3V to +6.0V
Output Voltages	
V_{RST} (N version)	-0.3V to +6.0V
V_{RST} , V_{RST} (H and L versions)	-0.3V to V_{DD} to +0.3V
Ambient Temperature (T_A)	-40°C to +85°C
Package Thermal Resistance (θ_{JA})	256°C/W

Electrical Characteristics⁽⁹⁾

Note 10; $T_A = +25^\circ\text{C}$, **bold** values indicate $-40^\circ\text{C} \leq T_A \leq +85^\circ\text{C}$, unless noted.

Symbol	Parameter	Condition	Min.	Typ.	Max.	Units
I_{DD}	Supply Current	$V_{DD} = V_{IN} = V_{TH} + 1.6\%$; Note 10; /MR, RST, /RST open		3.5		μA
VDD Voltage Threshold						
	Undervoltage Threshold on V_{DD} (See Standard Voltage Options table)		V_{TH-} 1.5%	V_{TH}	V_{TH+} 1.5%	V
V_{HYST}	Hysteresis Voltage			1		%
IN, Undervoltage Detector Input						
V_{REF}	Undervoltage Threshold	Note 10	295	300	305	mV
V_{HYST}	Hysteresis Voltage			3		mV
I_{IN}	Input Current			5		pA
		$T_{MIN} \leq T_A \leq T_{MAX}$			10	nA
RST, /RST Outputs						
t_{PROP}	Propagation Delay	$V_{IN} = (V_{REF(MAX)} + 100\text{mV})$ to $V_{IN} = (V_{REF(MIN)} - 100\text{mV})$, /MR = open		20		μs
t_{RST}	Reset Pulse Width	$T_{MIN} \leq T_A \leq T_{MAX}$	140		280	ms
V_{OL}	RST or /RST Output Voltage Low	$I_{SINK} = 1.6\text{mA}$; $V_{DD} \geq 1.6\text{V}$			0.3	V
		$I_{SINK} = 100\mu\text{A}$; $V_{DD} \geq 1.2\text{V}$; Note 11			0.3	V
V_{OH}	RST or /RST Output Voltage High (H and L versions)	$I_{SOURCE} = 500\mu\text{A}$; $V_{DD} \geq 1.5\text{V}$	$0.8 \times V_{DD}$			V
		$I_{SOURCE} = 10\mu\text{A}$; $V_{DD} \geq 1.2\text{V}$; Note 11	$0.8 \times V_{DD}$			V

Notes:

- Exceeding the absolute maximum ratings may damage the device.
- The device is not guaranteed to function outside its operating ratings.
- Devices are ESD sensitive. Handling precautions are recommended. Human body model, 1.5k Ω in series with 100pF.
- Specification for packaged product only
- V_{DD} equals nominal "Typical Application (V_{DD})" as shown in the [Standard Voltage Options](#) table.
- V_{DD} operating range is 1.5V to 5.5V. Output is guaranteed to be asserted down to $V_{DD} = 1.2\text{V}$.

Electrical Characteristics⁽⁹⁾

Note 10; $T_A = +25^\circ\text{C}$, **bold** values indicate $-40^\circ\text{C} \leq T_A \leq +85^\circ\text{C}$, unless noted.

Symbol	Parameter	Condition	Min.	Typ.	Max.	Units
/MR Inputs						
V_{IH}	Input High Voltage	Note 10	$0.7 \times V_{DD}$			V
V_{IL}	Input Low Voltage	Note 10			$0.3 \times V_{DD}$	%
t_{PROP}	Propagation Delay	$V_{MR} < (V_{IL} - 100\text{mV})$; Note 10		5		μs
t_{MIN}	Minimum Input Pulse Width	Reset occurs, $V_{MR} < V_{IL}$		33		ns
I_{PU}	Internal Pull-Up Current			100	250	nA
I_{IN}	Input Current, /MR	$V_{MR} < V_{IL}$		100	250	nA

Timing Diagram



Notes:

- 12. Propagation delays not shown for clarity.
- 13. The MIC2774 ignores very brief transients. See the [Application Information](#) section for details.

Functional Diagram

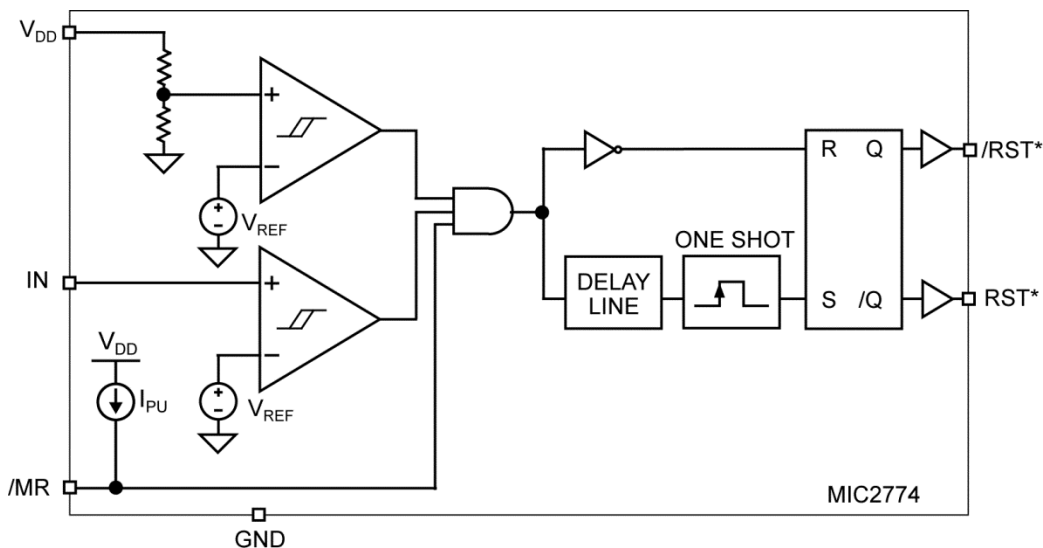

Note: *Pinout and polarity vary by device type. See the [Ordering Information](#) table.

Functional Description

IN, Undervoltage Detector Input

The voltage present at the IN pin is compared to the internal 300mV reference voltage. A reset is triggered if and when V_{IN} falls below V_{REF} . Typically, a resistor divider is used to scale the input voltage to be monitored such that V_{IN} will fall below V_{REF} as the voltage being monitored falls below the desired trip-point. Hysteresis is employed to prevent chattering due to noise. The comparator on the IN pin is relatively immune to very brief negative-going transients.

VDD Input

The VDD pin is both the power supply terminal and a monitored input voltage. The voltage at this pin is continually compared against the internal reference. The trip-point at which a reset occurs is factory-programmed. A reset is triggered if and when V_{DD} falls below the trip-point. Hysteresis is employed to prevent chattering due to noise. The comparator on the VDD input is relatively immune to very brief negative-going transients.

RST, /RST Reset Output

Typically, the MIC2774 is used to monitor the power supplies of intelligent circuits such as microcontrollers and microprocessors. By connecting the appropriate reset output of an MIC2774 to the reset input of a μC or μP , the processor will be properly reset at power-on, power-down, and during brown-out conditions. In addition, asserting /MR, the manual reset input, will activate the reset function.

The reset output is asserted any time /MR is asserted if V_{IN} or V_{DD} drops below the corresponding threshold voltage. The reset output remains asserted for $t_{RST(min)}$ after V_{IN} and/or V_{DD} subsequently return above the threshold boundaries and/or /MR is released. A reset pulse is also generated at power-on. Hysteresis is included in the comparators to prevent chattering of the output due to noise.

/MR, Manual Reset Input

The ability to initiate a reset via external logic or a manual switch is provided in addition to the MIC2774's automatic supervisory functions. Driving the /MR input to a logic low causes an immediate and unconditional reset to occur. Assuming V_{IN} and V_{DD} are within tolerance when /MR is released (returns high), the reset output will be de-asserted no less than t_{RST} later. /MR may be driven by a logic signal or mechanical switch. Typically, a momentary push-button switch is connected such that /MR is shorted to ground when the switch contacts close. Switch debouncing is performed internally; the switch may be connected directly between /MR and GND. /MR is internally pulled-up to V_{DD} and may be left open if unused.

Application Information

Programming the Voltage Threshold

Referring to the *Typical Application* circuit, the voltage threshold on the IN pin is calculated as follows:

$$V_{IH} = V_{REF} \times \frac{(R1+R2)}{R2}$$

where $V_{REF} = 0.300V$

In order to provide the additional criteria needed to solve for the resistor values, the resistors can be selected such that the two resistors have a given total value; that is, $R1 + R2 = R_{TOTAL}$. Imposing this condition on the resistor values provides two equations that can be solved for the two unknown resistor values. A value such as $1M\Omega$ for R_{TOTAL} is a reasonable choice because it keeps quiescent current to a generally acceptable level while not causing any measurable errors due to input bias currents. The larger the resistors, the larger the potential errors due to input bias current (I_{IN}). The maximum recommended value of R_{TOTAL} is $3M\Omega$.

Applying this criteria and rearranging the V_{IH} expression to solve for the resistor values gives:

$$R2 = \frac{(R_{TOTAL})(V_{REF})}{V_{IH}}$$

$$R1 = R_{TOTAL} - R2$$

Application Example

Figure 1 illustrates a hypothetical MIC2774L-23 application in which the MIC2774L-23 is used to monitor the core and I/O supplies of a high-performance CPU or DSP. The core supply, V_{CORE} , in the example is $1.0V \pm 5\%$. The main power rail and I/O voltage, $V_{I/O}$, is $2.5V \pm 5\%$. As shown in Figure 1, the MIC2774 is powered by $V_{I/O}$. The minimum value of $V_{I/O}$ is $2.5V - 5\% = 2.375V$; the maximum is $2.5V + 5\% = 2.625V$. This is well within the device's supply range of $1.5V$ to $5.5V$.

Resistors R1 and R2 must be selected to correspond to the V_{CORE} supply of $1.0V$. The goal is to ensure that the core supply voltage is adequate to ensure proper operation; i.e., $V_{CORE} \geq (1.0V - 5\%) = 0.950V$. Because there is always a small degree of uncertainty due to the accuracy of the resistors, variations in the device's voltage reference, etc., the threshold will be set slightly below this value. The potential variation in the MIC2774's voltage reference (V_{REF}) is specified as $\pm 1.5\%$. The resistors chosen will have their own tolerance specifications. This example assumes the use of 1% accurate resistors. The potential worst-case error contribution due to input bias current can be calculated once the resistor values are chosen. If the guidelines

above regarding the maximum total value of $R1 + R2$ are followed, this error contribution will be very small thanks to the MIC2774's very low input bias current.

To summarize, the various potential error sources are:

- Variation in V_{REF} : specified at $\pm 1.5\%$
- Resistor tolerance: chosen by designer (typically $\leq \pm 1\%$)
- Input bias current, I_{IN} : calculated once resistor values are known, typically very small

Taking the various potential error sources into account, the threshold voltage will be set slight below the minimum V_{CORE} specification of $0.950V$ so that when the actual threshold voltage is at its maximum, it will not intrude into the normal operating range of V_{CORE} . The target threshold voltage will be set as follows:

Given that the total tolerance on V_{TH} for the IN pin is [V_{REF} tolerance] + [resistor tolerance]

$$= \pm 1.5\% + \pm 1\% = \pm 2.5\%,$$

$$\text{and } V_{TH(max)} = V_{CORE(min)},$$

$$\text{then } V_{CORE(min)} = V_{TH} + 2.5\% V_{TH} = 1.025 V_{TH},$$

therefore, solving for V_{TH} results in

$$V_{TH} = \frac{V_{CORE(min)}}{1.025} = \frac{0.950}{1.025} = 0.9268V$$

Solving for R1 and R2 using this value for V_{TH} and the equations above yields:

$$R1 = 676.3k\Omega \approx 673k\Omega$$

$$R2 = 323.7k\Omega \approx 324k\Omega$$

The resulting circuit is shown in Figure 1.

Input Bias Current Effects

Now that the resistor values are known, it is possible to calculate the maximum potential error due to input bias current, I_{IN} . As shown in the *Electrical Characteristics* table, the maximum value of I_{IN} is $10nA$. Note that the typical value is a much smaller $5pA$. The magnitude of the offset caused by I_{IN} is given by:

$$V_{ERROR} = I_{IN(max)} \times (R1 || R2) =$$

$$V_{ERROR} = \pm 1 \times 10^{-8} A \times 2.189 \times 10^5 \Omega =$$

$$V_{ERROR} = \pm 2.189 \times 10^{-3} V =$$

$$V_{ERROR} = \pm 2.189mV$$

The typical error is about three orders of magnitude lower than this—close to one microvolt. Generally, the error due to input bias can be discounted. If it is to be taken into account, simply adjust the target threshold voltage downward by this amount and recalculate R1 and R2. The resulting value will be very close to optimum. If accuracy is more important than the quiescent current in

the resistors, simply reduce the value of R_{TOTAL} to minimize offset errors.



Figure 1. MIC2774 Example Design

Interfacing to Processors with Bidirectional Reset Pins

Some microprocessors have reset signal pins that are bidirectional, rather than input-only. The Motorola 68HC11 family is one example. Because the MIC2774N's output is open-drain, it can be connected directly to the processor's reset pin using only the pull-up resistor normally required. See Figure 2.



Figure 2. Interfacing to Bidirectional Reset Pin

Transient Response

The MIC2774 is inherently immune to very short negative-going glitches. Very brief transients may exceed the voltage thresholds without tripping the output.

In general, as shown in Figure 3 and Figure 4, the narrower the transient, the deeper the threshold overdrive that the MIC2774 will ignore. The graphs represent the typical allowable transient duration for a given amount of threshold overdrive that will not generate a reset.

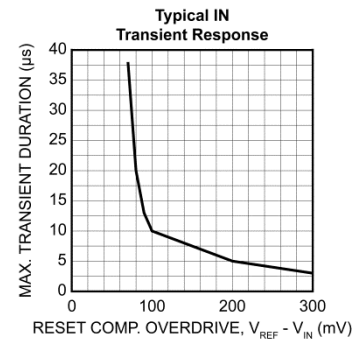

Figure 3. Typical Input Transient Response



Figure 4. Typical V_{DD} Transient Response

Ensuring Proper Operation at Low Supply

At V_{DD} levels below 1.2V, the MIC2774's reset output cannot turn on sufficiently to produce a valid logic-low on /RST. In this situation, circuits driven by /RST could be allowed to float, causing undesired operation. In most cases, however, it is expected that the circuits driven by the MIC2774L will be similarly inoperative at $V_{DD} \leq 1.2V$.

If a given application requires that /RST be valid below $V_{DD} = 1.2V$, this can be accomplished by adding a pull-down resistor to the /RST output. A value of 100kΩ is recommended because this is usually an acceptable compromise of quiescent current and pull-down current. The resistor's value is not critical, however. See Figure 5.

These statements also apply to the MIC2774H's RST output. That is, to ensure valid RST signal levels at $V_{DD} < 1.2V$, a pull-up resistor (as opposed to a pull-down) should be added to the RST output. A value of $100k\Omega$ is typical for this application, as well. See Figure 6.

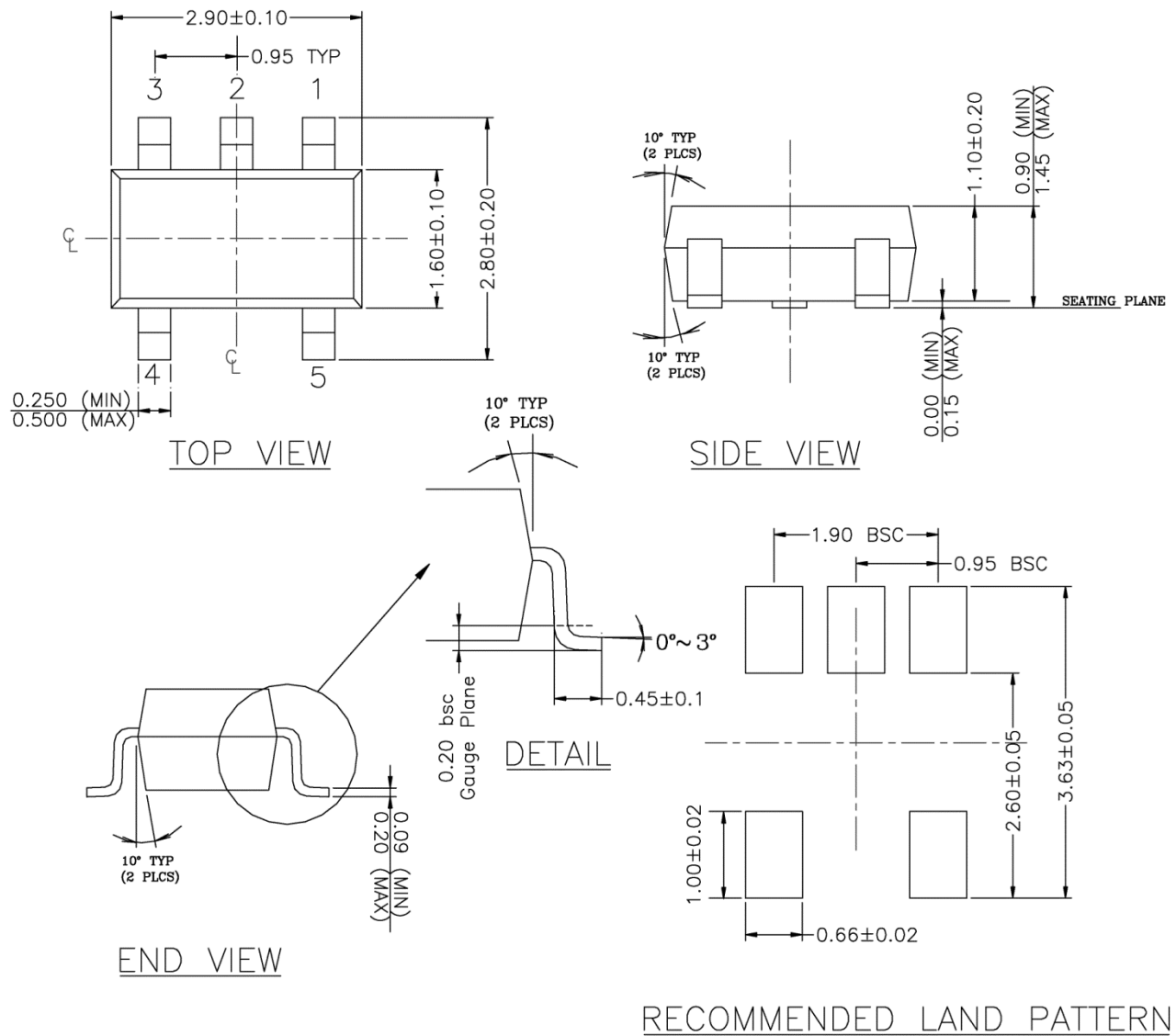

Figure 5. MIC2774L Valid /RST Below 1.2V



Figure 6. MIC2774H Valid RST Below 1.2V

Package Information and Recommended Landing Pattern⁽¹⁴⁾



- NOTE:
1. PACKAGE OUTLINE EXCLUSIVE OF MOLD FLASH & BURR.
 2. PACKAGE OUTLINE INCLUSIVE OF SOLER PLATING.
 3. DIMENSION AND TOLERANCE PER ANSI Y14.5M, 1982.
 4. FOOT LENGTH MEASUREMENT BASED ON GAUGE PLANE METHOD.
 5. DIE FACES UP FOR MOLD, AND FACES DOWN FOR TRIM/FORM.
 6. ALL DIMENSIONS ARE IN MILLIMETERS.

SOT-23-5 (M5)

Note:

14. Package information is correct as of the publication date. For updates and most current information, go to www.micrel.com.

MICREL, INC. 2180 FORTUNE DRIVE SAN JOSE, CA 95131 USA
TEL +1 (408) 944-0800 FAX +1 (408) 474-1000 WEB <http://www.micrel.com>

Micrel, Inc. is a leading global manufacturer of IC solutions for the worldwide high performance linear and power, LAN, and timing & communications markets. The Company's products include advanced mixed-signal, analog & power semiconductors; high-performance communication, clock management, MEMs-based clock oscillators & crystal-less clock generators, Ethernet switches, and physical layer transceiver ICs. Company customers include leading manufacturers of enterprise, consumer, industrial, mobile, telecommunications, automotive, and computer products. Corporation headquarters and state-of-the-art wafer fabrication facilities are located in San Jose, CA, with regional sales and support offices and advanced technology design centers situated throughout the Americas, Europe, and Asia. Additionally, the Company maintains an extensive network of distributors and reps worldwide.

Micrel makes no representations or warranties with respect to the accuracy or completeness of the information furnished in this datasheet. This information is not intended as a warranty and Micrel does not assume responsibility for its use. Micrel reserves the right to change circuitry, specifications and descriptions at any time without notice. No license, whether express, implied, arising by estoppel or otherwise, to any intellectual property rights is granted by this document. Except as provided in Micrel's terms and conditions of sale for such products, Micrel assumes no liability whatsoever, and Micrel disclaims any express or implied warranty relating to the sale and/or use of Micrel products including liability or warranties relating to fitness for a particular purpose, merchantability, or infringement of any patent, copyright, or other intellectual property right.

Micrel Products are not designed or authorized for use as components in life support appliances, devices or systems where malfunction of a product can reasonably be expected to result in personal injury. Life support devices or systems are devices or systems that (a) are intended for surgical implant into the body or (b) support or sustain life, and whose failure to perform can be reasonably expected to result in a significant injury to the user. A Purchaser's use or sale of Micrel Products for use in life support appliances, devices or systems is a Purchaser's own risk and Purchaser agrees to fully indemnify Micrel for any damages resulting from such use or sale.

© 2004 Micrel, Incorporated.

Looking for pricing, stock, or lifecycle information?

Click below to explore more details on WIN SOURCE:

- ⊖ [View MIC2774N-28BM5 on WIN SOURCE](#)
- ⊖ [Microchip Technology](#) Information

Optimize Your Supply Chain with WIN SOURCE Solutions

- ✓ Global Sourcing Solution
- ✓ Obsolete Management
- ✓ Cost Control Management
- ✓ Shortage Management
- ✓ Alternative Solution
- ✓ Excess Inventory Management