



**THE DATASHEET OF
MIC2293-34YML-TR**



General Description

The MIC2292 and MIC2293 are high frequency, Pulse Width Modulator (PWM) boost regulators optimized for constant-current, white LED driver applications. Because of their constant PWM switching frequencies of 1.6MHz and 2MHz, respectively, the MIC2292/93 can use the smallest external components, allowing designers to avoid sensitive IF bands in their RF applications.

The products feature an internal Schottky diode and two levels of output overvoltage protection allowing a small size and efficient DC/DC solution that requires only four external components.

The 2.5V to 10V input voltage range of MIC2292/3 allows direct operation from 1- and 2-cell Li Ion as well as 3- to 4-cell NiCad/NiMH/Alkaline batteries. The MIC2292/3 products are available in a small size 2mm × 2mm 8-lead MLF[®] package and have a junction temperature range of -40°C to +125°C.

All support documentation can be found on Micrel's web site at [www: micrel.com](http://www.micrel.com).

Features

- 2.5V to 10V input voltage
- Output voltage up to 34V
- Internal Schottky diode
- 1.6MHz PWM operation (MIC2292)
- 2.0MHz PWM operation (MIC2293)
- Stable with ceramic capacitors
- 15V and 34V output overvoltage protection options
- 500mA switch current rating
- 95mV feedback voltage
- <1% line and load regulation
- <1µA shutdown current
- Over-temperature protection
- UVLO
- 8-lead (2mm × 2mm) MLF[®] package
- -40°C to +125°C junction temperature range

Applications

- White LED driver for backlighting
 - Cell phones
 - PDAs
 - GPS systems
 - Digital cameras
 - MP3 players
 - IP phones
- Constant current power supplies

Typical Application

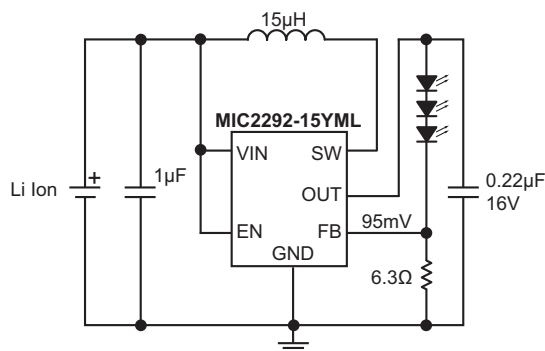

1.6MHz PWM White LED Driver with 15V OVP

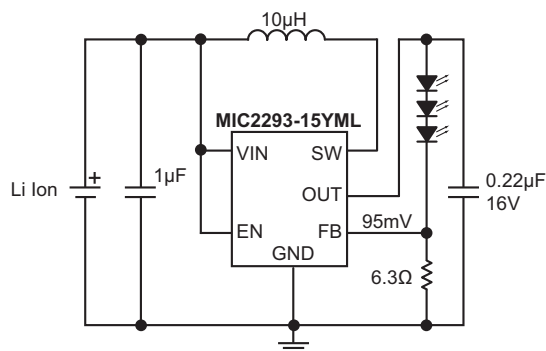

2MHz PWM White LED Driver with 15V OVP

Ordering Information

Part Number	Marking Code	Oversvoltage Protection	Frequency	Junction Temp. Range	Package	Lead Finish
MIC2292-15BML	SWA	15V	1.6MHz	-40°C to +125°C	8-lead MLF [®]	Standard
MIC2292-15YML	\bar{S} WA	15V	1.6MHz	-40°C to +125°C	8-lead MLF [®]	Pb-Free
MIC2292-34BML	SWC	34V	1.6MHz	-40°C to +125°C	8-lead MLF [®]	Standard
MIC2292-34YML	\bar{S} WC	34V	1.6MHz	-40°C to +125°C	8-lead MLF [®]	Pb-Free
MIC2293-15BML	SZA	15V	2MHz	-40°C to +125°C	8-lead MLF [®]	Standard
MIC2293-15YML	\bar{S} ZA	15V	2MHz	-40°C to +125°C	8-lead MLF [®]	Pb-Free
MIC2293-34BML	SZC	34V	2MHz	-40°C to +125°C	8-lead MLF [®]	Standard
MIC2293-34YML	\bar{S} ZC	34V	2MHz	-40°C to +125°C	8-lead MLF [®]	Pb-Free

Pin Configuration

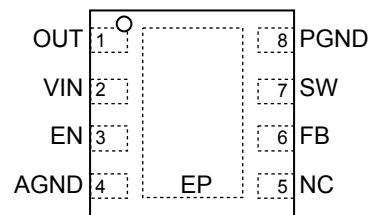

**8-lead MLF[®] (YML)
(Top View)**

Fused Lead Frame

Pin Description

Pin Number	Pin Name	Pin Function
1	OUT	Output pin and overvoltage protection (Output): Connect to the output capacitor and LEDs.
2	VIN	Supply (Input): Input voltage.
3	EN	Enable (Input): Logic high enables regulator. Logic low shuts down regulator.
5	NC	No connect (no internal connection to die).
6	FB	Feedback (Input): Output voltage sense node. Connect the cathode of the LED to this pin. A resistor from this pin to ground sets the LED current.
7	SW	Switch node (Input): Internal power transistor collector.
4,8	GND	Ground (Return): Ground.
EP	GND	Ground (Return): Exposed backside pad.

Absolute Maximum Ratings⁽¹⁾

Supply Voltage (V_{IN})	12V
Switch Voltage (V_{SW})	-0.3V to 34V
Enable Pin Voltage (V_{EN})	-0.3 to V_{IN}
FB Voltage (V_{FB})	6V
Switch Current (I_{SW})	2A
Ambient Storage Temperature (T_S)	-65°C to +150°C
Schottky Reverse Voltage (V_{DA})	34V
ESD Rating ⁽³⁾	2kV

Operating Ratings⁽²⁾

Supply Voltage (V_{IN})	2.5V to 10V
Output Voltage (V_{OUT})	V_{IN} to V_{OVP}
Junction Temperature Range (T_J)	-40°C to +125°C
Package Thermal Impedance	
8-lead MLF [®] (θ_{JA})	93°C/W

Electrical Characteristics⁽⁴⁾

$T_A = 25^\circ\text{C}$, $V_{IN} = V_{EN} = 3.6\text{V}$, $V_{OUT} = 15\text{V}$, $I_{OUT} = 20\text{mA}$, unless otherwise noted. **Bold** values indicate $-40^\circ\text{C} \leq T_J \leq +125^\circ\text{C}$.

Symbol	Parameter	Condition	Min	Typ	Max	Units
V_{IN}	Supply Voltage Range		2.5		10	V
V_{ULVO}	Under Voltage Lockout		1.8	2.1	2.4	V
I_{VIN}	Quiescent Current	$V_{FB} > 200\text{mV}$, (not switching)		2.5	5	mA
I_{SD}	Shutdown Current	$V_{EN} = 0\text{V}^{(5)}$		0.1	1	μA
V_{FB}	Feedback Voltage	($\pm 5\%$)	90	95	100	mV
I_{FB}	Feedback Input Current	$V_{FB} = 95\text{mV}$		-450		nA
	Line Regulation ⁽⁶⁾	$3\text{V} \leq V_{IN} \leq 5\text{V}$		0.5	1	%
	Load Regulation ⁽⁶⁾	$5\text{mA} \leq I_{OUT} \leq 20\text{mA}$		0.5	2	%
D_{MAX}	Maximum Duty Cycle		85	90		%
I_{SW}	Switch Current Limit			750		mA
V_{SW}	Switch Saturation Voltage	$I_{SW} = 0.5\text{A}$		450		mV
I_{SW}	Switch Leakage Current	$V_{EN} = 0\text{V}$, $V_{SW} = 10\text{V}$		0.01	5	μA
V_{EN}	Enable Threshold	TURN ON TURN OFF	1.5		0.4	V V
I_{EN}	Enable Pin Current	$V_{EN} = 10\text{V}$		20	40	μA
f_{SW}	Oscillator Frequency	MIC2292 MIC2293	1.4 1.75	1.6 2.0	1.8 2.25	MHz MHz
V_D	Schottky Forward Drop	$I_D = 150\text{mA}$		0.8	1	V
I_{RD}	Schottky Leakage Current	$V_R = 30\text{V}$			4	μA
V_{OVP}	Overvoltage Protection	MIC2292/93-15 MIC2292/93-34	13 30	14 32	16 34	V V
T_J	Overtemperature Threshold Shutdown	Hysteresis		150 10		$^\circ\text{C}$ $^\circ\text{C}$

Notes:

1. Absolute maximum ratings indicate limits beyond which damage to the component may occur. Electrical specifications do not apply when operating the device outside of its operating ratings. The maximum allowable power dissipation is a function of the maximum junction temperature, $T_J(\text{max})$, the junction-to-ambient thermal resistance, θ_{JA} , and the ambient temperature, T_A . The maximum allowable power dissipation will result in excessive die temperature, and the regulator will go into thermal shutdown.
2. This device is not guaranteed to operate beyond its specified operating ratings.
3. Devices are inherently ESD sensitive. Handling precautions required. Human body model.
4. Specification for packaged product only.
5. $I_{SD} = I_{VIN}$.
6. Guaranteed by design.

Typical Characteristics

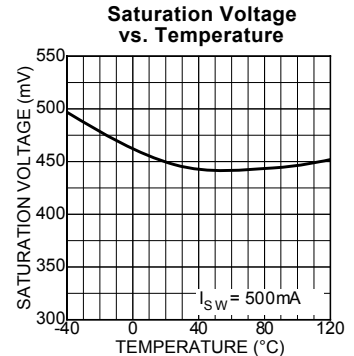
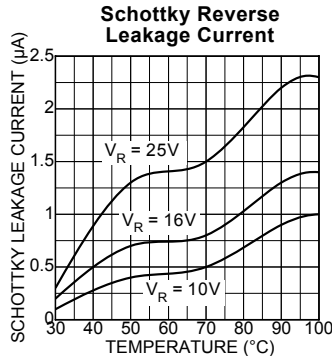
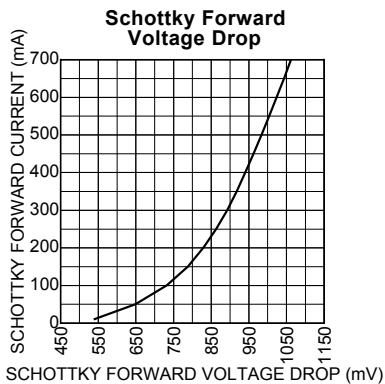
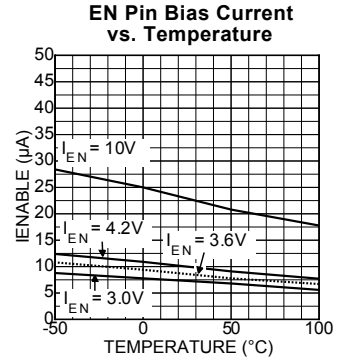
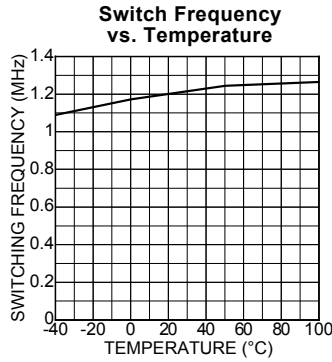
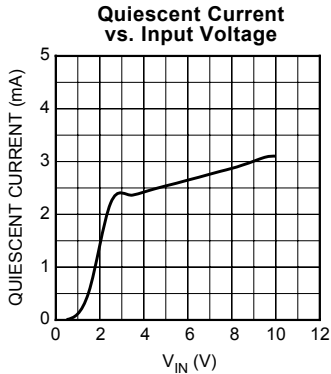
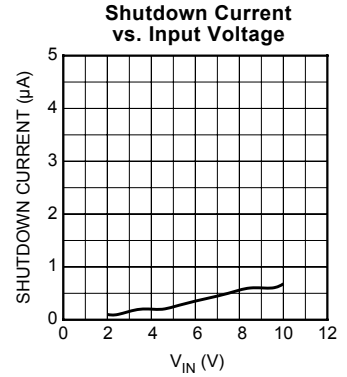
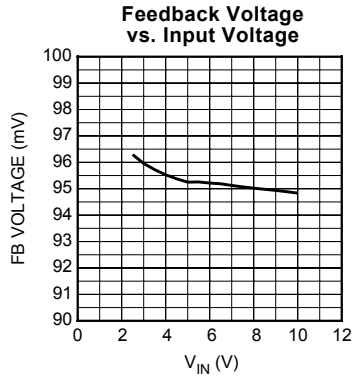
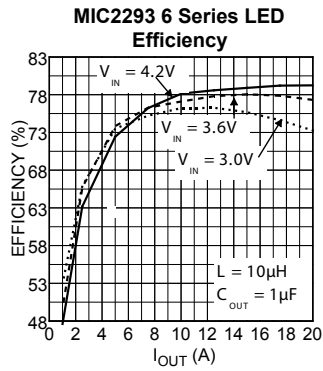
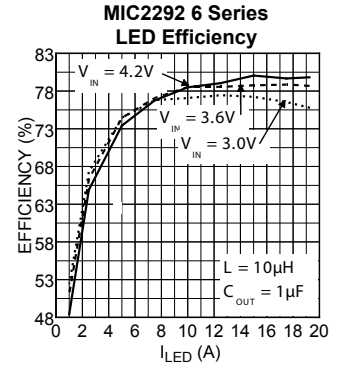
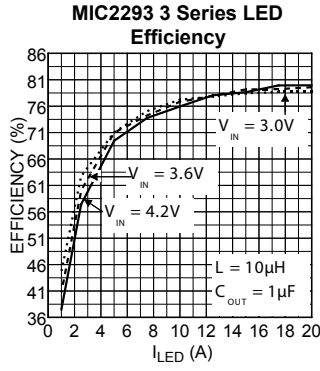
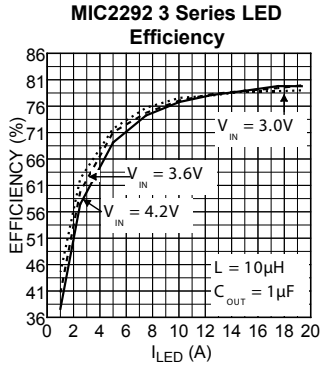

Switch Frequency vs. Temperature

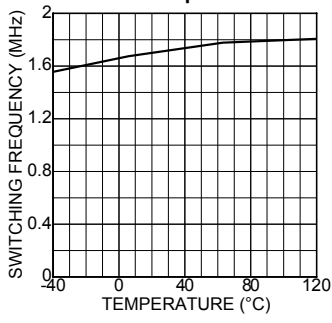

Switch Saturation Voltage vs. Current

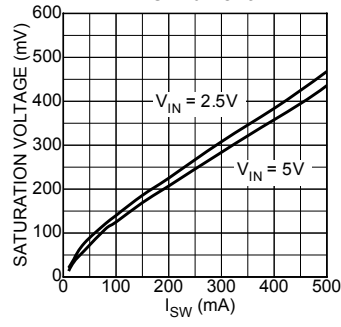

Current Limit vs. Temperature

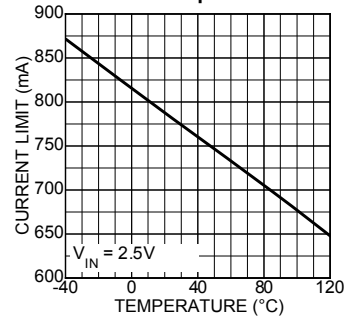

Functional Diagram

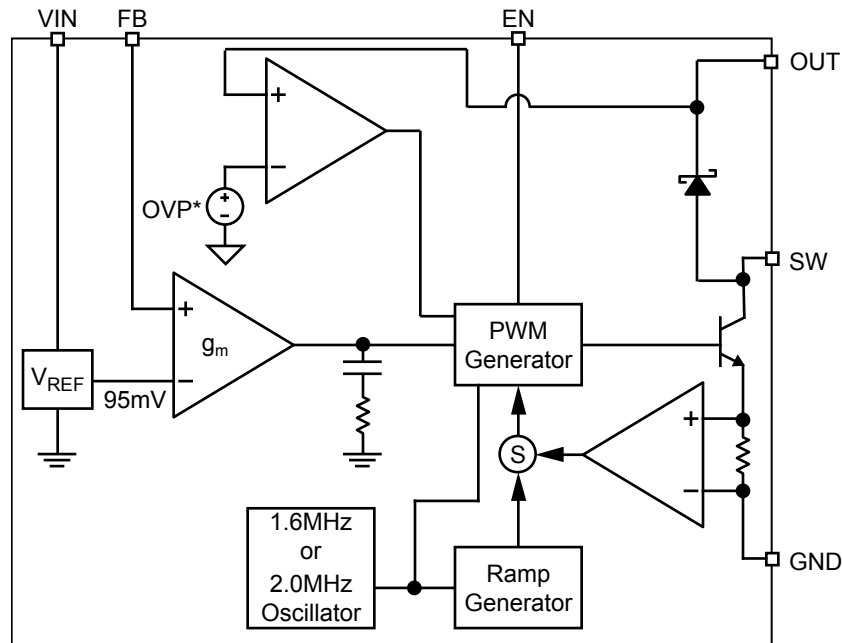

MIC2292/93 Block Diagram

Functional Description

The MIC2292/93 is a constant frequency, PWM current mode boost regulator. The block diagram is shown above. The MIC2292/93 is composed of an oscillator, slope compensation ramp generator, current amplifier, g_m error amplifier, PWM generator, 500mA bipolar output transistor, and Schottky rectifier diode. The oscillator generates a 1.6MHz clock for the MIC2292 and a 2.0MHz clock for the MIC2293. The clocks' two functions are to trigger the PWM generator that turns on the output transistor and to reset the slope compensation ramp generator. The current amplifier is used to measure the switch current by amplifying the voltage signal from the internal sense resistor. The output of the current amplifier is summed with the output of the slope compensation ramp generator. This summed current-loop signal is fed to one of the inputs of the PWM generator.

The g_m error amplifier measures the LED current through the external sense resistor and amplifies the error between the detected signal and the 95mV reference voltage. The output of the g_m error amplifier provides the voltage-loop signal that is fed to the other input of the PWM generator. When the current-loop signal exceeds the voltage-loop signal, the PWM generator turns off the bipolar output transistor. The next clock period initiates the next switching cycle, maintaining the constant frequency current-mode PWM control. The LED is set by the feedback resistor:

$$I_{LED} = \frac{95\text{mV}}{R_{FB}}$$

The Enable pin shuts down the output switching and disables control circuitry to reduce input current to leakage levels. Enable pin input current is zero at zero volts.

External Component Selection

The MIC2292/93 can be used across a wide range of applica-

tions. The table below shows recommended inductor and output capacitor values for various series-LED applications:

Series LEDs	L	Manufacturer	Min C _{OUT}	Manufacturer
2	22 μ H	LQH32CN220K21 (Murata) NLC453232T-220K(TDK)	2.2 μ F	0805ZD225KAT(AVX) GRM40X5R225K10(Murata)
	15 μ H	LQH32CN150K21 (Murata) NLC453232T-150K(TDK)	1 μ F	0805ZD105KAT(AVX) GRM40X5R105K10(Murata)
	10 μ H	LQH32CN100K21 (Murata) NLC453232T-100K(TDK)	0.22 μ F	0805ZD224KAT(AVX) GRM40X5R224K10(Murata)
	6.8 μ H	LQH32CN6R8K21 (Murata) NLC453232T-6R8K(TDK)	0.22 μ F	0805ZD225KAT(AVX) GRM40X5R225K10(Murata)
	4.7 μ H	LQH32CN4R7K21 (Murata) NLC453232T-4R7K(TDK)	0.22 μ F	0805ZD224KAT(AVX) GRM40X5R224K10(Murata)
3	22 μ H	LQH43MN220K21 (Murata) NLC453232T-220K(TDK)	2.2 μ F	0805YD225MAT(AVX) GRM40X5R225K16(Murata)
	15 μ H	LQH43MN 150K21 (Murata) NLC453232T-150K(TDK)	1 μ F	0805YD105MAT(AVX) GRM40X5R105K16(Murata)
	10 μ H	LQH43MN 100K21 (Murata) NLC453232T-100K(TDK)	0.22 μ F	0805YD224MAT(AVX) GRM40X5R224K16(Murata)
	6.8 μ H	LQH43MN 6R8K21 (Murata) NLC453232T-6R8K(TDK)	0.22 μ F	0805YD224MAT(AVX) GRM40X5R224K16(Murata)
	4.7 μ H	LQH43MN 4R7K21 (Murata) NLC453232T-4R7K(TDK)	0.27 μ F	0805YD274MAT(AVX) GRM40X5R224K16(Murata)
4	22 μ H	LQH43MN220K21 (Murata) NLC453232T-220K(TDK)	1 μ F	0805YD105MAT(AVX) GRM40X5R105K25(Murata)
	15 μ H	LQH43MN 150K21 (Murata) NLC453232T-150K(TDK)	1 μ F	0805YD105MAT(AVX) GRM40X5R105K25(Murata)
	10 μ H	LQH43MN 100K21 (Murata) NLC453232T-100K(TDK)	0.27 μ F	0805YD274MAT(AVX) GRM40X5R274K25(Murata)
	6.8 μ H	LQH43MN 6R8K21 (Murata) NLC453232T-6R8K(TDK)	0.27 μ F	0805YD274MAT(AVX) GRM40X5R274K25(Murata)
	4.7 μ H	LQH43MN 4R7K21 (Murata) NLC453232T-4R7K(TDK)	0.27 μ F	0805YD274MAT(AVX) GRM40X5R274K25(Murata)
5, 6	22 μ H	LQH43MN220K21 (Murata) NLC453232T-220K(TDK)	0.22 μ F	08053D224MAT(AVX) GRM40X5R224K25(Murata)
	15 μ H	LQH43MN 150K21 (Murata) NLC453232T-150K(TDK)	0.22 μ F	08053D224MAT(AVX) GRM40X5R224K25(Murata)
	10 μ H	LQH43MN 100K21 (Murata) NLC453232T-100K(TDK)	0.27 μ F	08053D274MAT(AVX) GRM40X5R274K25(Murata)
	6.8 μ H	LQH43MN 6R8K21 (Murata) NLC453232T-6R8K(TDK)	0.27 μ F	08053D274MAT(AVX) GRM40X5R274K25(Murata)
	4.7 μ H	LQH43MN 4R7K21 (Murata) NLC453232T-4R7K(TDK)	0.27 μ F	08053D274MAT(AVX) GRM40X5R274K25(Murata)
7, 8	22 μ H	LQH43MN220K21 (Murata) NLC453232T-220K(TDK)	0.22 μ F	08053D224MAT(AVX) GRM40X5R224K25(Murata)
	15 μ H	LQH43MN 150K21 (Murata) NLC453232T-150K(TDK)	0.22 μ F	08053D224MAT(AVX) GRM40X5R224K25(Murata)
	10 μ H	LQH43MN 100K21 (Murata) NLC453232T-100K(TDK)	0.27 μ F	08053D274MAT(AVX) GRM40X5R274K25(Murata)
	6.8 μ H	LQH43MN 6R8K21 (Murata) NLC453232T-6R8K(TDK)	0.27 μ F	08053D274MAT(AVX) GRM40X5R274K25(Murata)
	4.7 μ H	LQH43MN 4R7K21 (Murata) NLC453232T-4R7K(TDK)	0.27 μ F	08053D274MAT(AVX) GRM40X5R274K25(Murata)

Dimming Control

There are two techniques for dimming control. One is PWM dimming and the other is continuous dimming.

1. PWM dimming control is implemented by applying a PWM signal on EN pin as shown in Figure 1. The MIC2292/93 is turned on and off by the PWM signal. With this method, the LEDs operate with either zero or full current. The average LED current is increased proportionally to the duty-cycle of the PWM signal. This technique has high-efficiency because the IC and the LEDs consume no current during the off cycle of the PWM signal. Typical frequency should be between 100Hz and 10kHz.
2. Continuous dimming control is implemented by applying a DC control voltage to the FB pin of the MIC2292/93 through a series resistor as shown in Figure 2. The LED current is decreased proportionally with the amplitude of the control voltage. The LED intensity (current) can be dynamically varied applying a DC voltage to the FB pin. The DC voltage can come from a DAC signal or a filtered PWM signal. The advantage of this approach is that a high frequency PWM signal (>10kHz) can be used to control LED intensity.

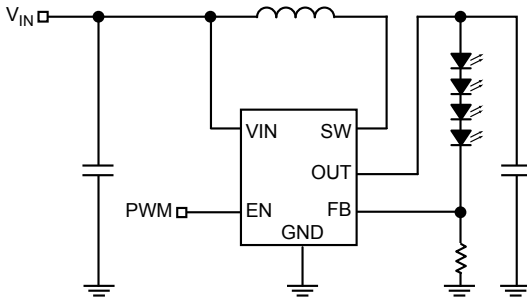

Figure 1. PWM Dimming Method

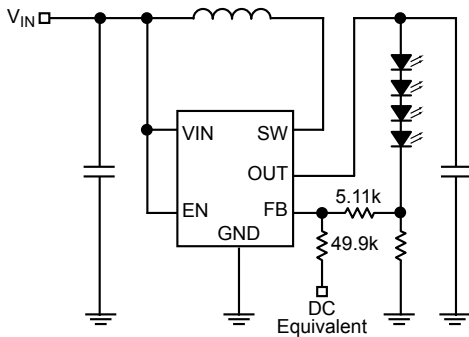

Figure 2. Continuous Dimming

Open-Circuit Protection

If the LEDs are disconnected from the circuit, or in case an LED fails open, the sense resistor will pull the FB pin to ground. This will cause the MIC2292/93 to switch with a high duty-cycle resulting in output overvoltage. This may cause the SW pin voltage to exceed its maximum voltage rating, possibly damaging the IC and the external components. To ensure the highest level of protection, the MIC2292/93 has two product options in the 8-lead MLF[®] with overvoltage protection, OVP. The extra pins of the 8-lead MLF[®] package allow the use of a dedicated OVP monitor with options for 15V or 34V (see Figure 3). The reason for the two OVP levels is to let users choose the suitable level of OVP for their application. For example, a 4-LED application would typically see an output voltage of no more than 12V, so a 15V OVP option would offer a suitable level of protection. This allows the user to select the output diode and capacitor with the lowest voltage ratings, and accordingly, smallest size and lowest cost. The OVP will clamp the output voltage to within the specified limits.

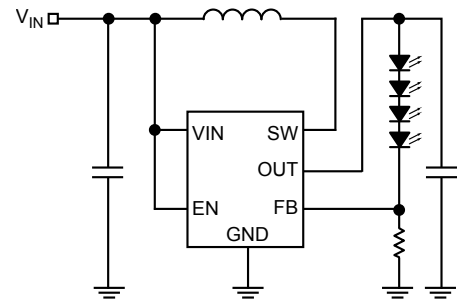

Figure 3. MLF[®] Package OVP Circuit

Start-Up and Inrush Current

During start-up, inrush current of approximately double the nominal current flows to set up the inductor current and the voltage on the output capacitor. If the inrush current needs to be limited, a soft-start circuit similar to Figure 4 could be implemented. The soft-start capacitor, C_{SS}, provides overdrive to the FB pin at start-up, resulting in gradual increase of switch duty cycle and limited inrush current.

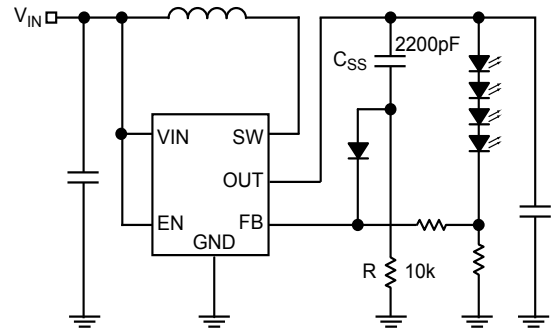
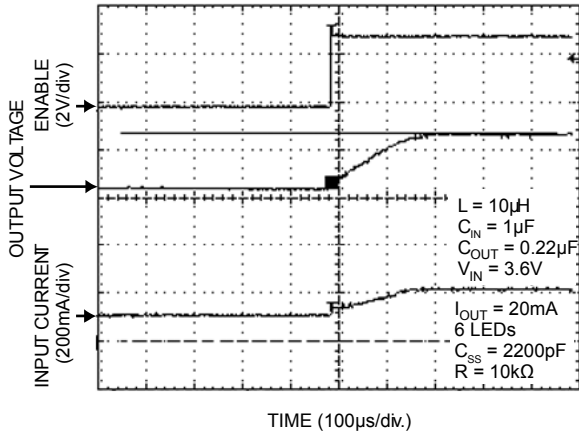

Figure 4. Soft-Start Circuit

Functional Characteristics

6-Series LED Circuit with External Soft-Start



6-Series LED Circuit without External Soft-Start

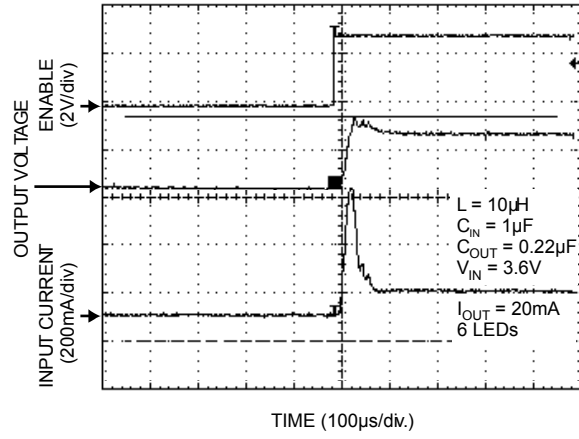

Package Information

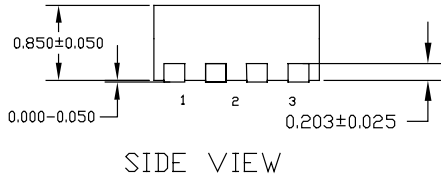
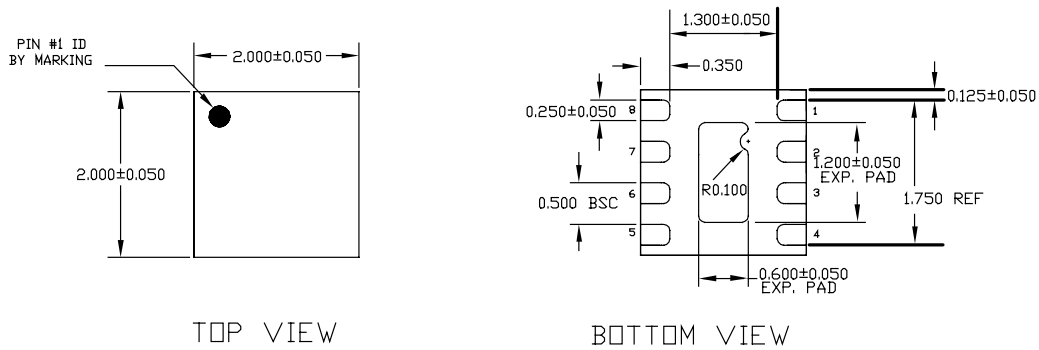

- NOTE:
1. ALL DIMENSIONS ARE IN MILLIMETERS.
 2. MAX. PACKAGE WARPAGE IS 0.05 mm.
 3. MAXIMUM ALLOWABLE BURRS IS 0.076 mm IN ALL DIRECTIONS.
 4. PIN #1 ID ON TOP WILL BE LASER/INK MARKED.

8-lead MLF® (YML)

MICREL INC. 2180 FORTUNE DRIVE SAN JOSE, CA 95131 USA
 TEL + 1 (408) 944-0800 FAX + 1 (408) 474-1000 WEB <http://www.micrel.com>

This information furnished by Micrel in this data sheet is believed to be accurate and reliable. However no responsibility is assumed by Micrel for its use. Micrel reserves the right to change circuitry and specifications at any time without notification to the customer.

Micrel Products are not designed or authorized for use as components in life support appliances, devices or systems where malfunction of a product can reasonably be expected to result in personal injury. Life support devices or systems are devices or systems that (a) are intended for surgical implant into the body or (b) support or sustain life, and whose failure to perform can be reasonably expected to result in a significant injury to the user. A Purchaser's use or sale of Micrel Products for use in life support appliances, devices or systems is a Purchaser's own risk and Purchaser agrees to fully indemnify Micrel for any damages resulting from such use or sale.

Looking for pricing, stock, or lifecycle information?

Click below to explore more details on WIN SOURCE:

- ⊖ [View MIC2293-34YML-TR on WIN SOURCE](#)
- ⊖ [Microchip Technology](#) Information

Optimize Your Supply Chain with WIN SOURCE Solutions

- ✓ Global Sourcing Solution
- ✓ Obsolete Management
- ✓ Cost Control Management
- ✓ Shortage Management
- ✓ Alternative Solution
- ✓ Excess Inventory Management