



**THE DATASHEET OF
MHVIC915NR2**



RF LDMOS Wideband Integrated Power Amplifier

The MHVIC915NR2 wideband integrated circuit is designed with on-chip matching that makes it usable from 750 to 1000 MHz. This multi-stage structure is rated for 26 to 28 Volt operation and covers all typical cellular base station modulation formats.

Final Application

- Typical Single-Carrier N-CDMA Performance: $V_{DD} = 27$ Volts, $I_{DQ1} = 80$ mA, $I_{DQ2} = 120$ mA, $P_{out} = 34$ dBm, Full Frequency Band (746 to 960 MHz), IS-95 CDMA (Pilot, Sync, Paging, Traffic Codes 8 Through 13)
Power Gain — 31 dB
Power Added Efficiency — 21%
ACPR @ 750 kHz Offset — -50 dBc in 30 kHz Bandwidth

Driver Applications

- Typical Single-Carrier N-CDMA Performance: $V_{DD} = 27$ Volts, $I_{DQ1} = 80$ mA, $I_{DQ2} = 120$ mA, $P_{out} = 23$ dBm, Full Frequency Band (869-894 MHz), IS-95 CDMA (Pilot, Sync, Paging, Traffic Codes 8 Through 13), Channel Bandwidth = 1.2288 MHz. PAR = 9.8 dB @ 0.01% Probability on CCDF.
Power Gain — 31 dB
Power Added Efficiency — 21%
ACPR @ 750 kHz Offset — -60 dBc in 30 kHz Bandwidth
ACPR @ 1.98 MHz Offset — -66 dBc in 30 kHz Bandwidth
- Typical GSM Performance: $V_{DD} = 26$ Volts, $P_{out} = 15$ W P1dB, Full Frequency Band (921-960 MHz)
Power Gain — 30 dB @ P1dB
Power Added Efficiency = 56% @ P1dB
- Capable of Handling 3:1 VSWR, @ 27 Vdc, 880 MHz, 15 Watts CW Output Power
- Characterized with Series Equivalent Large-Signal Impedance Parameters
- On-Chip Matching (50 Ohm Input, DC Blocked, >9 Ohm Output)
- Integrated Quiescent Current Temperature Compensation with Enable/Disable Function
- On-Chip Current Mirror g_m Reference FET for Self Biasing Application (1)
- Integrated ESD Protection
- RoHS Compliant
- In Tape and Reel. R2 Suffix = 1,500 Units per 16 mm, 13 inch Reel.

MHVIC915NR2

**746-960 MHz, 15 W, 27 V
SINGLE N-CDMA, GSM/GSM EDGE
RF LDMOS WIDEBAND
INTEGRATED POWER AMPLIFIER**

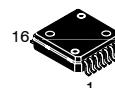

**CASE 978-03
PFP-16
PLASTIC**

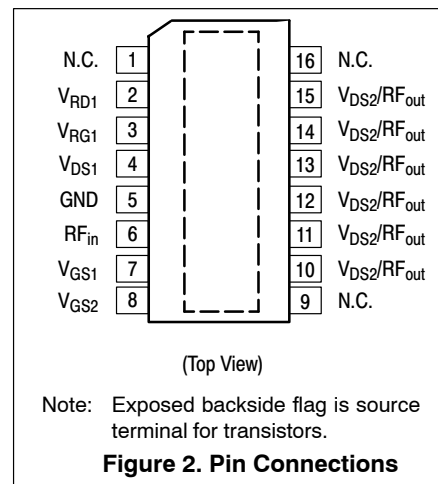
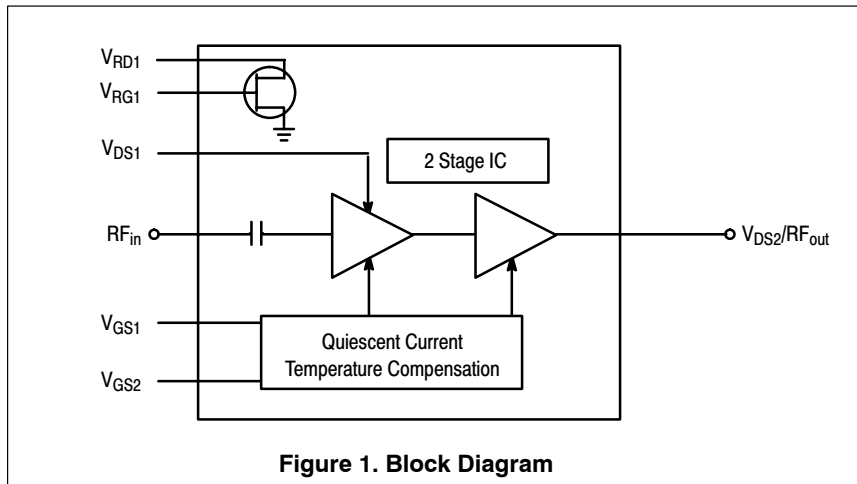

1. Refer to AN1987, *Quiescent Current Control for the RF Integrated Circuit Device Family*. Go to <http://www.freescale.com/rf>. Select Documentation/Application Notes - AN1987.

Table 1. Maximum Ratings

Rating	Symbol	Value	Unit
Drain-Source Voltage	V_{DSS}	-0.5, +65	Vdc
Gate-Source Voltage	V_{GS}	-0.5, +15	Vdc
Storage Temperature Range	T_{stg}	-65 to +150	°C
Operating Junction Temperature	T_J	150	°C

Table 2. Thermal Characteristics

Characteristic	Symbol	Value ⁽¹⁾	Unit
Thermal Resistance, Junction to Case	$R_{\theta JC}$		°C/W
Driver Application ($P_{out} = 0.2$ W CW)	Stage 1, 27 Vdc, $I_{DQ} = 80$ mA Stage 2, 27 Vdc, $I_{DQ} = 120$ mA	15.1 5.1	
Output Application ($P_{out} = 2.5$ W CW)	Stage 1, 27 Vdc, $I_{DQ} = 80$ mA Stage 2, 27 Vdc, $I_{DQ} = 120$ mA	15.8 5.0	
GSM Application ($P_{out} = 15$ W CW)	Stage 1, 26 Vdc, $I_{DQ} = 50$ mA Stage 2, 26 Vdc, $I_{DQ} = 140$ mA	13.8 4.5	

Table 3. ESD Protection Characteristics

Test Methodology	Class
Human Body Model (per JESD22-A114)	0 (Minimum)
Machine Model (per EIA/JESD22-A115)	A (Minimum)
Charge Device Model (per JESD22-C101)	II (Minimum)

Table 4. Moisture Sensitivity Level

Test Methodology	Rating	Package Peak Temperature	Unit
Per JESD 22-A113, IPC/JEDEC J-STD-020	3	260	°C

Table 5. Electrical Characteristics ($T_C = 25^\circ\text{C}$ unless otherwise noted)

Characteristic	Symbol	Min	Typ	Max	Unit
Power Gain ($P_{out} = 23$ dBm)	G_{ps}	29	31	—	dB
Power Added Efficiency ($P_{out} = 34$ dBm)	PAE	—	21	—	%
Input Return Loss ($P_{out} = 23$ dBm)	IRL	—	-12	-9	dB
Adjacent Channel Power Ratio ($P_{out} = 23$ dBm)	ACPR	—	-60	-55	dBc
Adjacent Channel Power Ratio ($P_{out} = 34$ dBm)	ACPR	—	-50	—	dBc
Gain Flatness @ $P_{out} = 23$ dBm (865 MHz to 895 MHz)	G_F	—	0.2	0.4	dB
Bias Sense FET Drain Current $V_{BSD} = 27$ V $V_{BIAS\ BSG} = V_{BIAS2\ Q2}$ @ $I_{DQ2} = 120$ mA	I_{BSD}	0.8	1.2	1.6	mA

1. Refer to AN1955, *Thermal Measurement Methodology of RF Power Amplifiers*. Go to <http://www.freescale.com/rf>. Select Documentation/Application Notes - AN1955.

(continued)

Table 5. Electrical Characteristics ($T_C = 25^\circ\text{C}$ unless otherwise noted) (continued)

Characteristic	Symbol	Min	Typ	Max	Unit
Typical Performances (In Freescale Test Fixture, 50 ohm system) $V_{DD} = 27\text{ Vdc}$, $I_{DQ1} = 80\text{ mA}$, $I_{DQ2} = 120\text{ mA}$, 865-895 MHz					
Quiescent Current Accuracy over Temperature (-10 to 85°C) at Nominal Value (1)	ΔI_{QT}	—	± 5	—	%
Gain Flatness in 30 MHz Bandwidth @ $P_{out} = 23\text{ dBm}$ (800 MHz to 960 MHz)	G_F	—	0.20	—	dB
Deviation from Linear Phase in 30 MHz Bandwidth @ $P_{out} = 23\text{ dBm}$	Φ	—	± 0.2	—	°
Group Delay @ $P_{out} = 23\text{ dBm}$ Including Output Matching	Delay	—	2.2	—	ns
Part to Part Phase Variation @ $P_{out} = 23\text{ dBm}$	$\Phi\Delta$	—	± 10	—	°

Typical GSM Performances (In Freescale GSM Test Fixture, 50 ohm system) $V_{DD} = 26\text{ Vdc}$, $I_{DQ1} = 50\text{ mA}$, $I_{DQ2} = 140\text{ mA}$, 921-960 MHz, CW

Output Power, 1 dB Compression Point	P1dB	—	15	—	W
Power Gain @ P1dB	G_{ps}	—	30	—	dB
Power Added Efficiency @ P1dB	PAE	—	56	—	%
Input Return Loss @ P1dB	IRL	—	-16	—	dB
Error Vector Magnitude @ 5 W	—	—	0.9	—	%
Intermodulation Distortion (15 W PEP, 2-Tone, 100 kHz Tone Spacing)	IMD	—	-30	—	dBc
Power Added Efficiency (15 W PEP, 2-Tone, 100 kHz Tone Spacing)	PAE	—	35	—	%

1. Refer to AN1977, *Quiescent Current Thermal Tracking Circuit in the RF Integrated Circuit Family*. Go to <http://www.freescale.com/rf>. Select Documentation/Application Notes - AN1977.

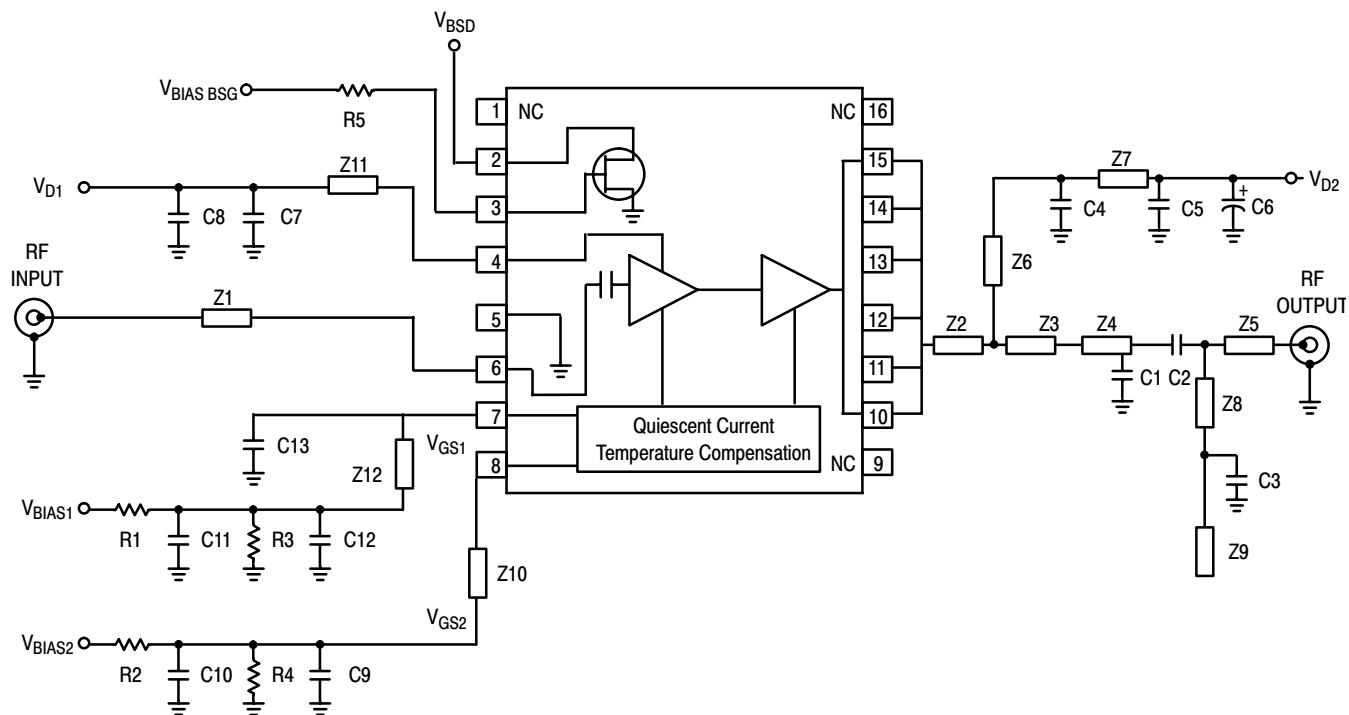

Z1	0.0438" x 0.400" 50 Ω Microstrip	Z7	0.0504" x 0.480" Microstrip
Z2	0.1709" x 0.1004" Microstrip (not including IC pad length)	Z8	0.0252" x 0.843" Microstrip
Z3	0.1222" x 0.1944" Microstrip	Z9	0.0252" x 0.167" Microstrip
Z4	0.0836" x 0.3561" Microstrip	Z10	0.040" x 0.850" Microstrip
Z5	0.0438" x 0.2725" Microstrip	Z11	0.025" x 0.400" Microstrip
Z6	0.0504" x 0.3378" Microstrip	Z12	0.020" x 0.710" Microstrip
		PCB	Rogers 4350, 0.020", $\epsilon_r = 3.50$

Figure 3. MHVIC915NR2 Test Circuit Schematic

Table 6. MHVIC915NR2 Test Circuit Component Designations and Values

Part	Description	Part Number	Manufacturer
C1, C2	4.7 pF High Q Capacitors (0603)	ATC600S4R7CW	ATC
C3, C4	47 pF NPO Capacitors (0805)	GRM40-001COG470J050BD	Murata
C5, C8, C10, C11	1 μF X7R Chip Capacitors (1214)	GRM42-2X7R105K050AL	Murata
C6	10 μF, 50 V Electrolytic Capacitor	ECEV1HA100SP	Panasonic
C7, C9, C12	0.01 μF X7R Chip Capacitors (0805)	GRM40X7R103J050BD	Murata
C13	8.2 pF NPO Chip Capacitor (0805)	GRM40-001COG8R2C050BD	Murata
R1, R2, R5	1 kΩ Chip Resistors (0603)	RM73B2AT102J	KOA Speer
R3, R4	100 kΩ Chip Resistors (0603)	RM73B2AT104J	KOA Speer

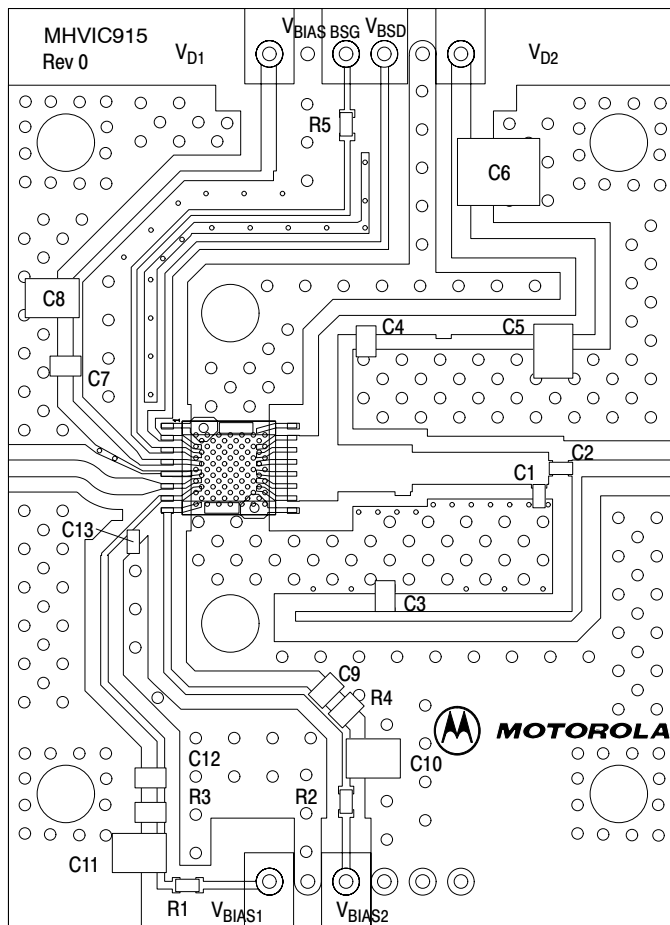

Freescale has begun the transition of marking Printed Circuit Boards (PCBs) with the Freescale Semiconductor signature/logo. PCBs may have either Motorola or Freescale markings during the transition period. These changes will have no impact on form, fit or function of the current product.

Figure 4. MHVIC915NR2 Test Circuit Component Layout

TYPICAL CHARACTERISTICS (FREESCALE TEST FIXTURE, 50 OHM SYSTEM)

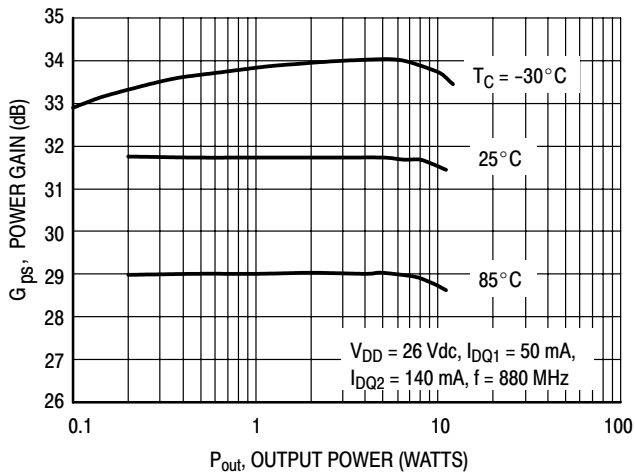

Figure 5. Power Gain versus Output Power

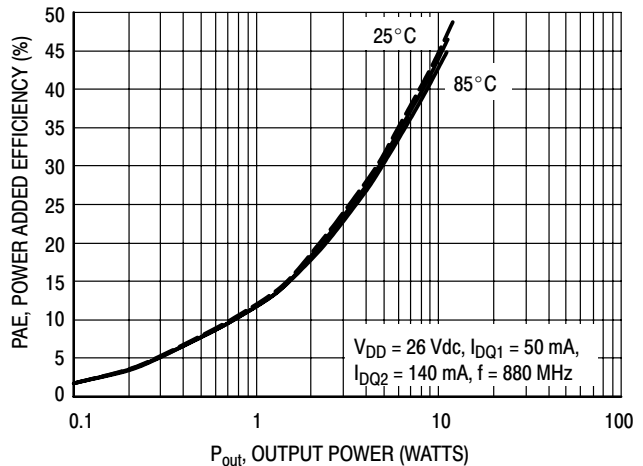

Figure 6. Power Added Efficiency versus Output Power

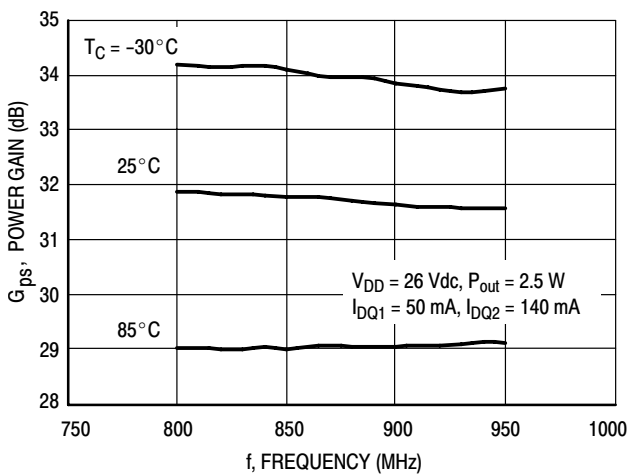

Figure 7. Power Gain versus Frequency

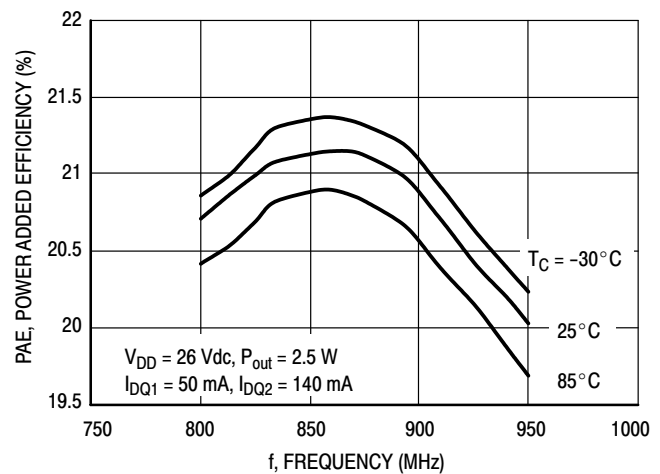

Figure 8. Power Added Efficiency versus Frequency

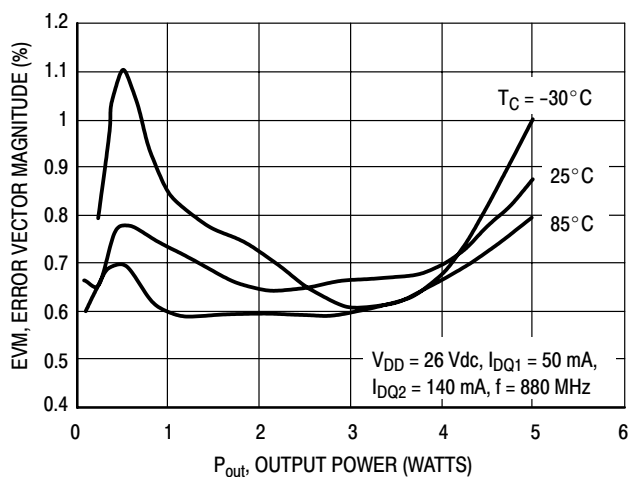

Figure 9. Error Vector Magnitude versus Output Power

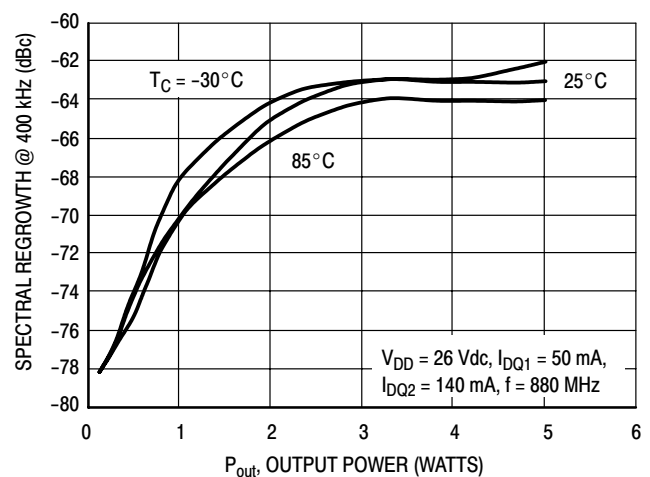

Figure 10. Spectral Regrowth @ 400 kHz versus Output Power

TYPICAL CHARACTERISTICS (FREESCALE TEST FIXTURE, 50 OHM SYSTEM)

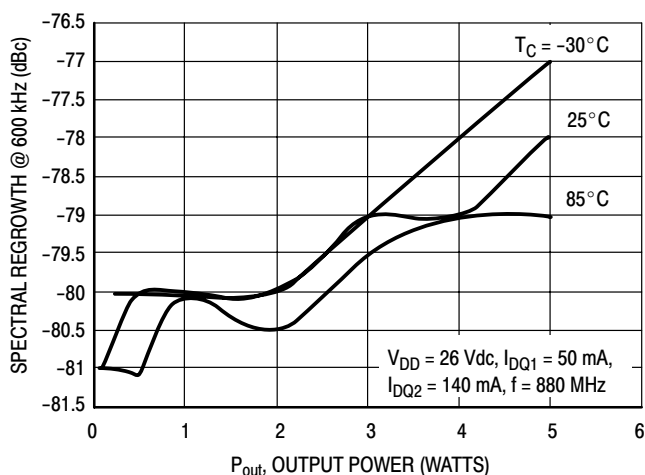

Figure 11. Spectral Regrowth @ 600 kHz versus Output Power

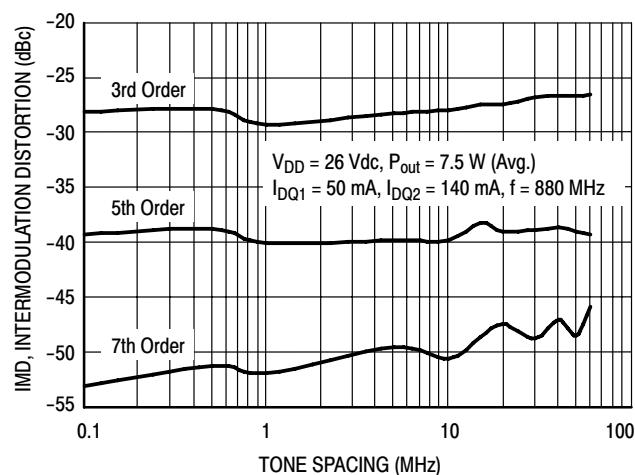

Figure 12. Two-Tone Broadband Performance

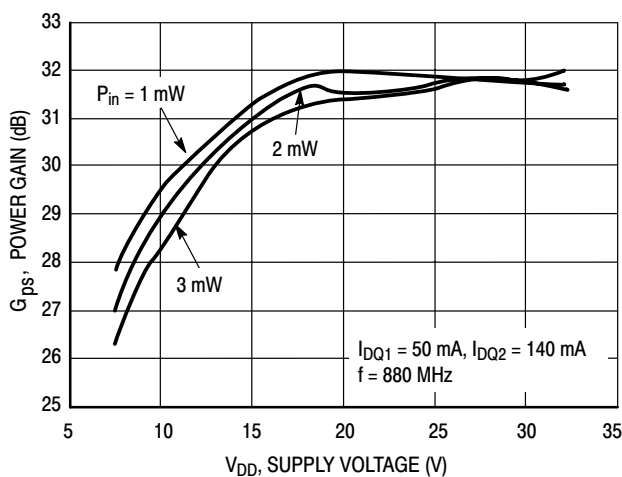

Figure 13. Power Gain versus Supply Voltage

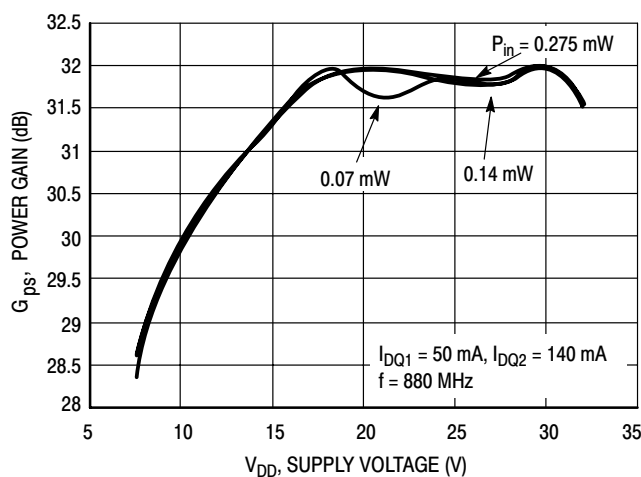

Figure 14. Power Gain versus Supply Voltage

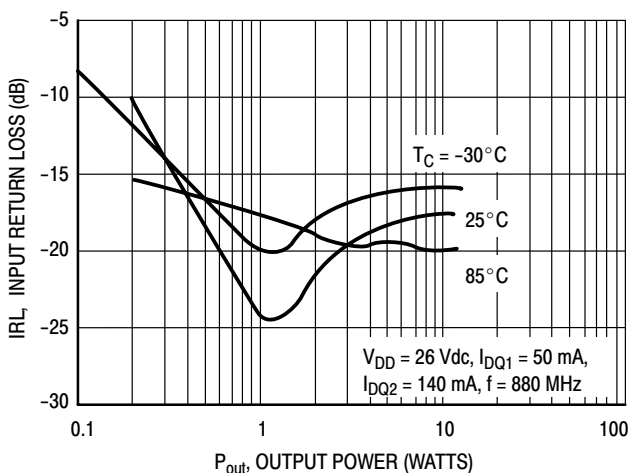

Figure 15. Input Return Loss versus Output Power

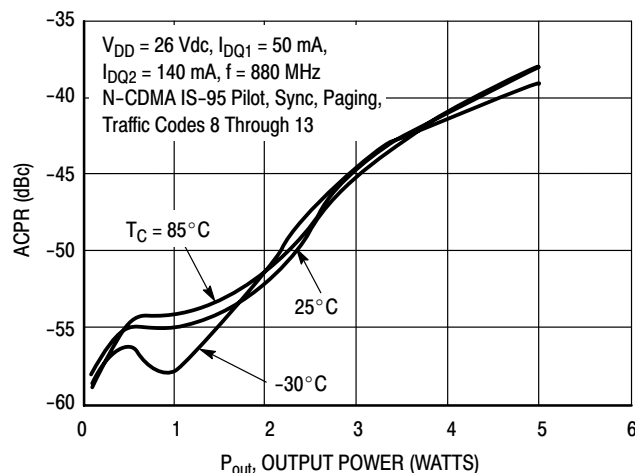
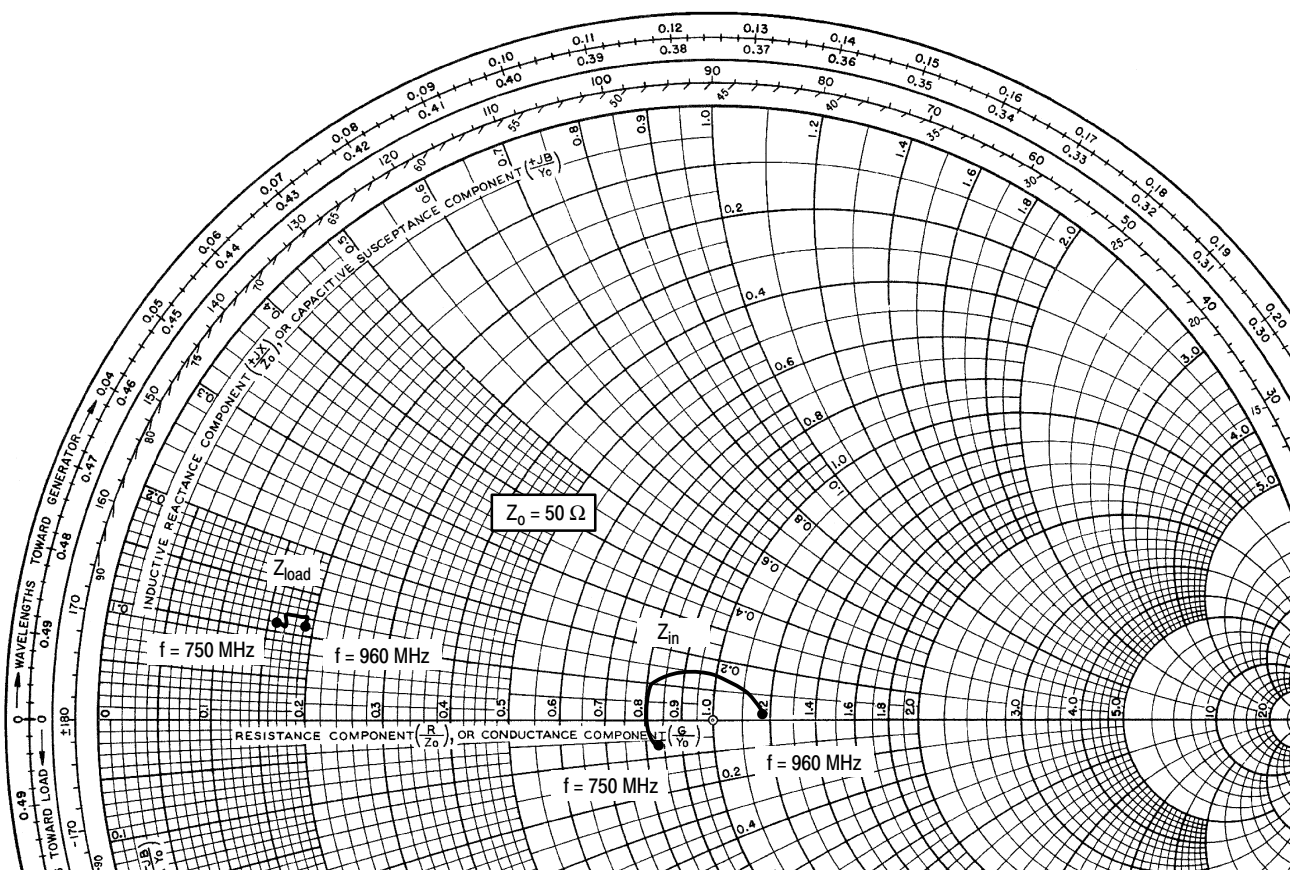

Figure 16. Adjacent Channel Power Ratio versus Output Power



$V_{DD} = 26 \text{ Vdc}$, $I_{DQ1} = 50 \text{ mA}$, $I_{DQ2} = 140 \text{ mA}$, $P_{out} = 1.25 \text{ W CW}$

f MHz	Z_{in} Ω	Z_{load} Ω
750	$42.11 - j2.79$	$8.24 + j5.33$
765	$40.86 - j1.37$	$8.31 + j5.56$
780	$40.09 + j0.06$	$8.39 + j5.82$
795	$39.77 + j1.52$	$8.50 + j5.95$
810	$39.89 + j3.01$	$8.62 + j6.02$
825	$40.49 + j4.39$	$8.82 + j6.12$
840	$41.48 + j5.70$	$8.94 + j6.19$
855	$42.89 + j6.73$	$9.12 + j6.17$
870	$43.51 + j7.03$	$9.16 + j6.12$
885	$46.81 + j7.87$	$9.33 + j6.09$
900	$49.21 + j7.74$	$9.38 + j5.95$
915	$51.79 + j7.02$	$9.50 + j5.85$
930	$54.48 + j5.65$	$9.47 + j5.73$
945	$57.05 + j3.61$	$9.54 + j5.63$
960	$59.16 + j0.75$	$9.42 + j5.45$

Z_{in} = Device input impedance as measured from RF input to ground.

Z_{load} = Test circuit impedance as measured from drain to ground.

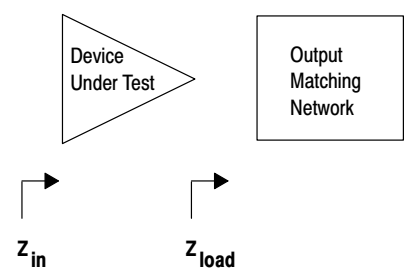
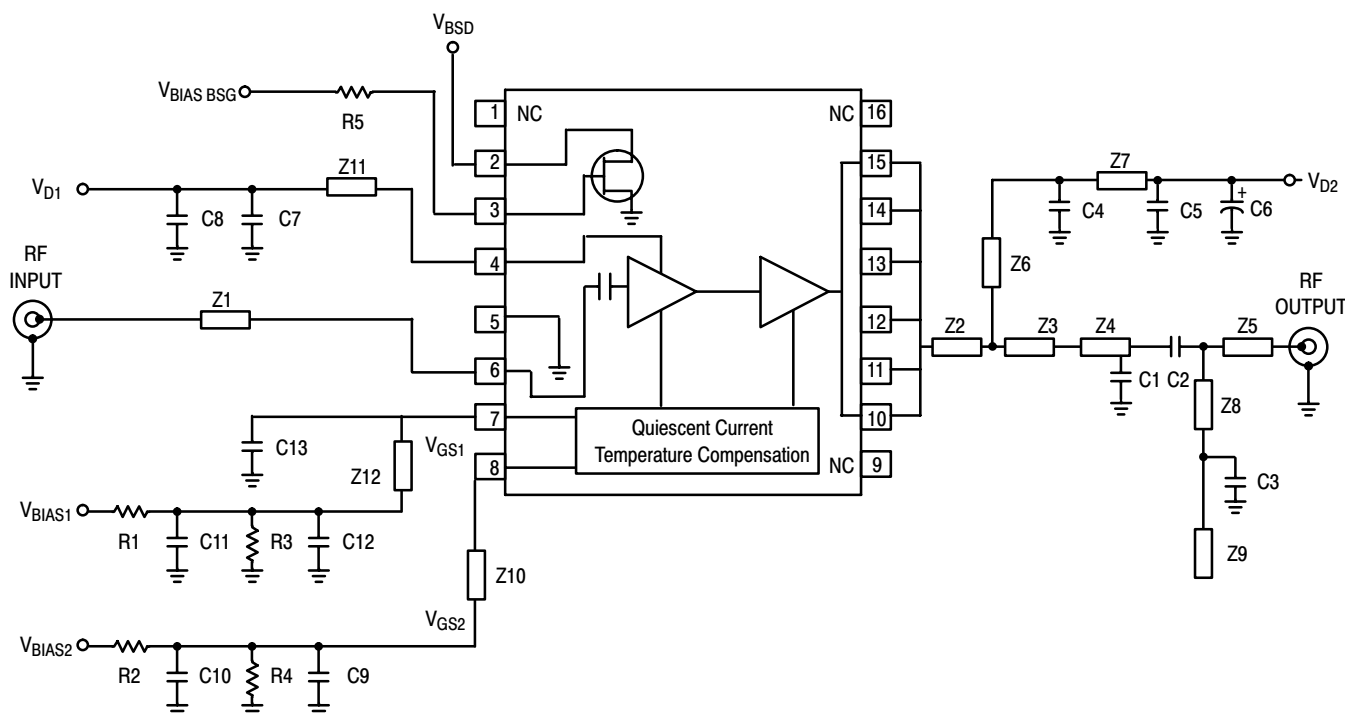

Figure 17. Series Equivalent Input and Load Impedance

DRIVER/PRE-DRIVER PERFORMANCE



Z1	0.0438" x 0.400" 50 Ω Microstrip	Z7	0.0504" x 0.480" Microstrip
Z2	0.1709" x 0.1004" Microstrip (not including IC pad length)	Z8	0.0252" x 0.843" Microstrip
Z3	0.1222" x 0.1944" Microstrip	Z9	0.0252" x 0.167" Microstrip
Z4	0.0836" x 0.3561" Microstrip	Z10	0.040" x 0.850" Microstrip
Z5	0.0438" x 0.2725" Microstrip	Z11	0.025" x 0.400" Microstrip
Z6	0.0504" x 0.3378" Microstrip	Z12	0.020" x 0.710" Microstrip
		PCB	Rogers 4350, 0.020", ε _r = 3.50

**Figure 18. MHVIC915NR2 Test Fixture Schematic—
Alternate Characterization for Driver/Pre-Driver Performance**

**Table 7. MHVIC915NR2 Test Fixture Component Designations and Values —
Alternate Characterization for Driver/Pre-Driver Performance**

Part	Description	Part Number	Manufacturer
C1, C2	2.4 pF High Q Capacitors (0603)	ATC600S4R7CW	ATC
C3, C4	47 pF NPO Capacitors (0805)	GRM40-001COG470J050BD	Murata
C5, C8, C10, C11	1 μF X7R Chip Capacitors (1214)	GRM42-2X7R105K050AL	Murata
C6	10 μF, 50 V Electrolytic Capacitor	ECEV1HA100SP	Panasonic
C7, C9, C12	0.01 μF X7R Chip Capacitors (0805)	GRM40X7R103J050BD	Murata
C13	8.2 pF NPO Chip Capacitor (0805)	GRM40-001COG8R2C050BD	Murata
R1, R2, R5	1 kΩ Chip Resistors (0603)	RM73B2AT102J	KOA Speer
R3, R4	100 kΩ Chip Resistors (0603)	RM73B2AT104J	KOA Speer

DRIVER/PRE-DRIVER PERFORMANCE

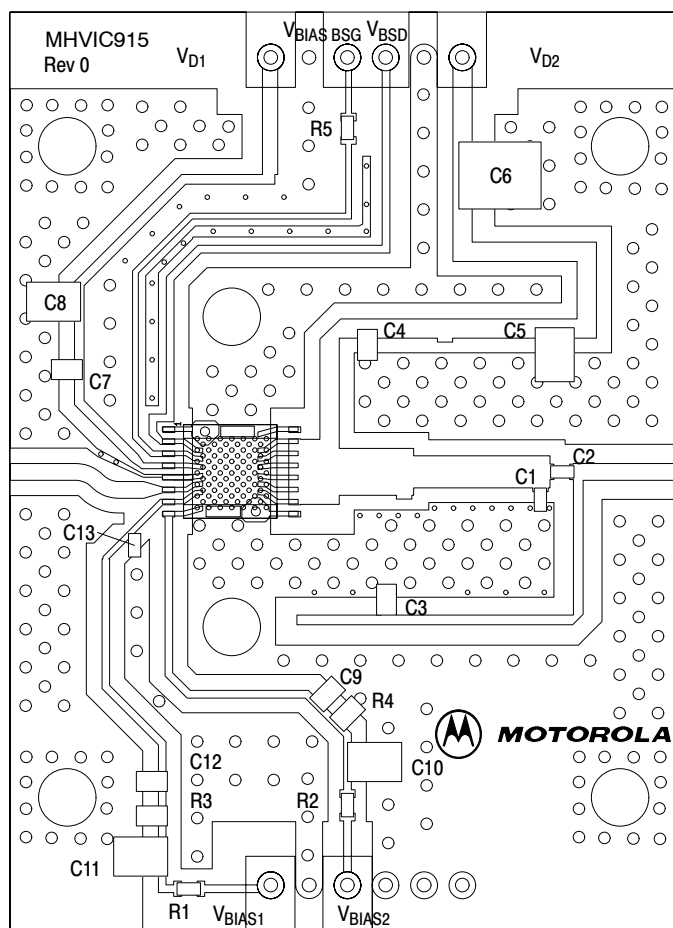

Freescale has begun the transition of marking Printed Circuit Boards (PCBs) with the Freescale Semiconductor signature/logo. PCBs may have either Motorola or Freescale markings during the transition period. These changes will have no impact on form, fit or function of the current product.

**Figure 19. MHVIC915NR2 Test Circuit Component Layout—
Alternate Characterization for Driver/Pre-Driver Performance**

**TYPICAL CHARACTERISTICS
DRIVER/PRE-DRIVER PERFORMANCE**

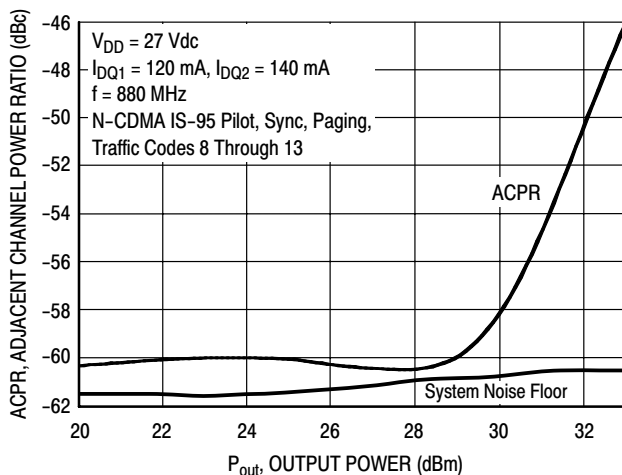

**Figure 20. Single-Carrier N-CDMA ACPR
versus Output Power**

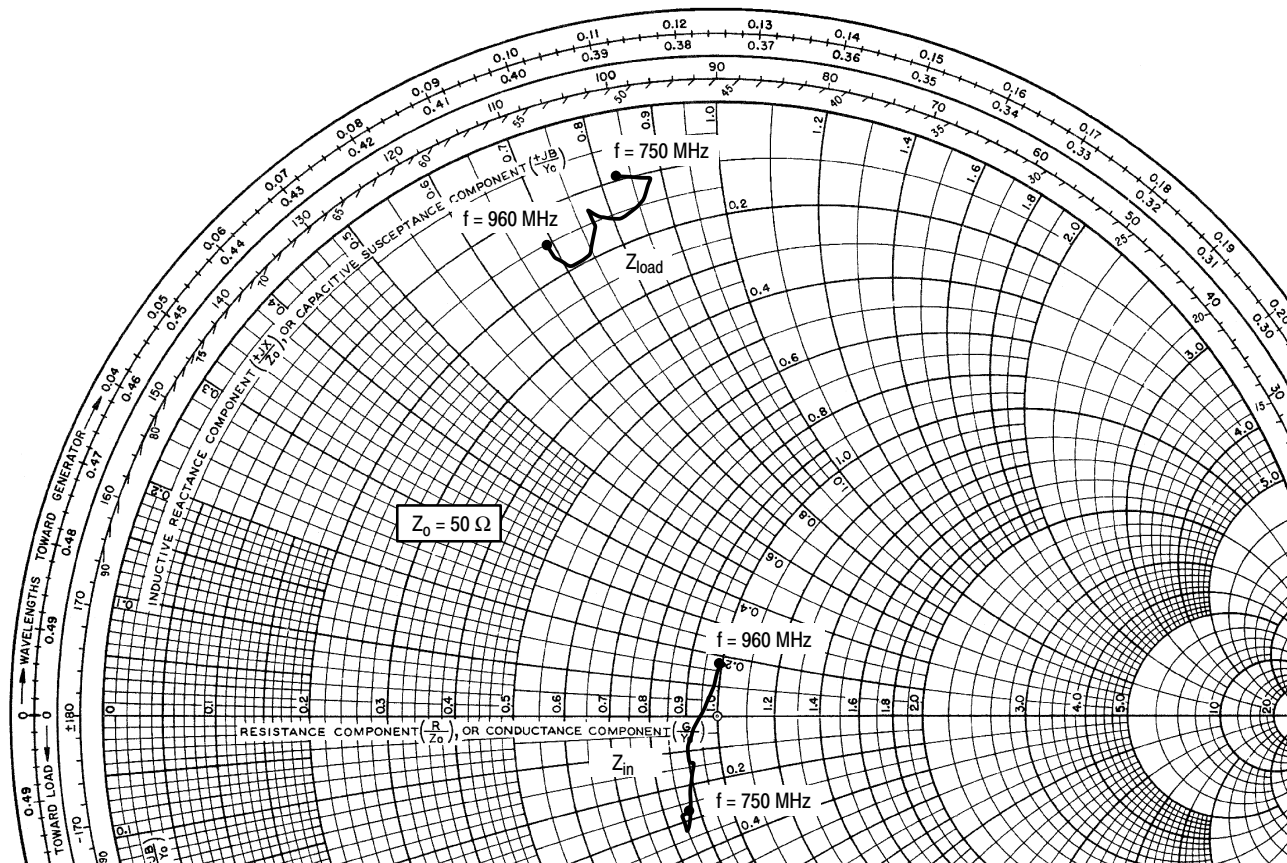

$V_{DD} = 27 \text{ Vdc}$, $I_{DQ1} = 120 \text{ mA}$, $I_{DQ2} = 140 \text{ mA}$, $P_{out} = 0.5 \text{ W CW}$

f MHz	Z_{in} Ω	Z_{load} Ω
750	43.5 - j13.4	4.7 + j41.5
765	42.9 - j13.9	5.5 + j43.8
780	42.7 - j14.2	6.0 + j43.7
795	42.3 - j15.9	6.8 + j42.8
810	42.7 - j16.0	7.5 + j42.2
825	44.5 - j10.5	7.8 + j40.5
840	45.5 - j7.0	7.2 + j39.2
855	45.0 - j6.5	6.3 + j38.4
870	45.0 - j4.5	6.4 + j38.7
885	46.0 - j1.5	7.9 + j38.5
900	48.3 + j2.4	9.3 + j36.8
915	49.5 + j7.3	9.4 + j35.3
930	49.6 + j7.8	8.6 + j34.5
945	49.8 + j8.4	7.8 + j34.3
960	49.5 + j8.6	7.6 + j34.3

Z_{in} = Device input impedance as measured from RF input to ground.

Z_{load} = Test circuit impedance as measured from drain to ground.

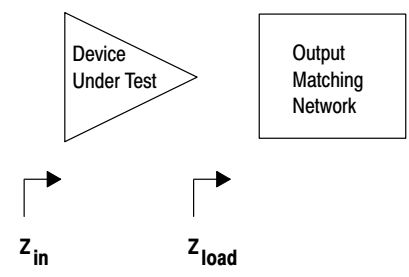
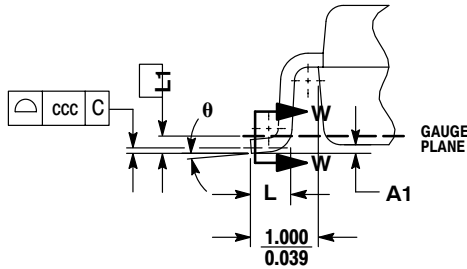
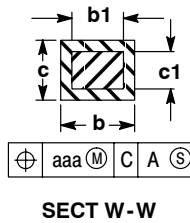
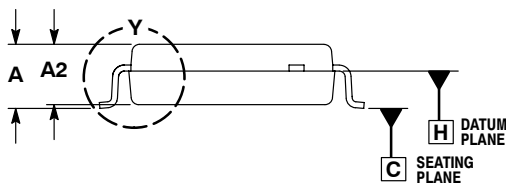
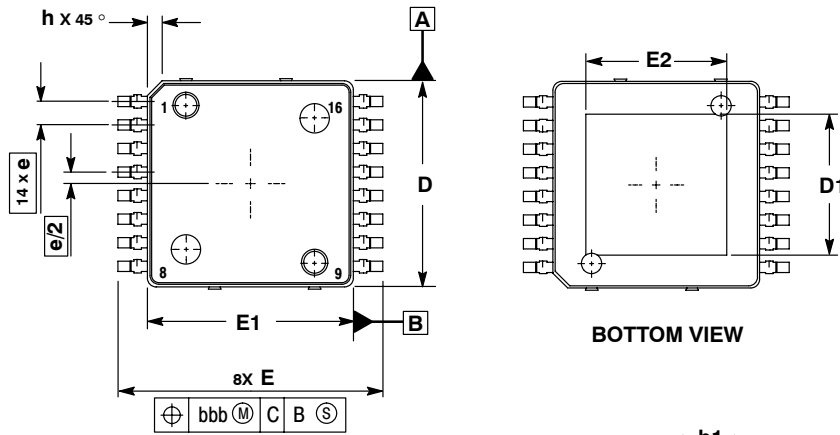

Figure 21. Series Equivalent Input and Load Impedance — Alternate Characterization for Driver/Pre-Driver Performance

NOTES

NOTES

PACKAGE DIMENSIONS



DETAIL Y

NOTES:

1. CONTROLLING DIMENSION: MILLIMETER.
2. DIMENSIONS AND TOLERANCES PER ASME Y14.5M, 1994.
3. DATUM PLANE -H- IS LOCATED AT BOTTOM OF LEAD AND IS COINCIDENT WITH THE LEAD WHERE THE LEAD EXITS THE PLASTIC BODY AT THE BOTTOM OF THE PARTING LINE.
4. DIMENSIONS D AND E1 DO NOT INCLUDE MOLD PROTRUSION. ALLOWABLE PROTRUSION IS 0.250 PER SIDE. DIMENSIONS D AND E1 DO INCLUDE MOLD MISMATCH AND ARE DETERMINED AT DATUM PLANE -H-.
5. DIMENSION b DOES NOT INCLUDE DAMBAR PROTRUSION. ALLOWABLE DAMBAR PROTRUSION IS 0.127 TOTAL IN EXCESS OF THE b DIMENSION AT MAXIMUM MATERIAL CONDITION.
6. DATUMS -A- AND -B- TO BE DETERMINED AT DATUM PLANE -H-.

DIM	MILLIMETERS	
	MIN	MAX
A	2.000	2.300
A1	0.025	0.100
A2	1.950	2.100
D	6.950	7.100
D1	4.372	5.180
E	8.850	9.150
E1	6.950	7.100
E2	4.372	5.180
L	0.466	0.720
L1	0.250	BSC
b	0.300	0.432
b1	0.300	0.375
c	0.180	0.279
c1	0.180	0.230
e	0.800	BSC
h	---	0.600
θ	0°	7°
aaa	0.200	
bbb	0.200	
ccc	0.100	

CASE 978-03
ISSUE C
PFP-16
PLASTIC

How to Reach Us:

Home Page:

www.freescale.com

E-mail:

support@freescale.com

USA/Europe or Locations Not Listed:

Freescale Semiconductor
Technical Information Center, CH370
1300 N. Alma School Road
Chandler, Arizona 85224
+1-800-521-6274 or +1-480-768-2130
support@freescale.com

Europe, Middle East, and Africa:

Freescale Halbleiter Deutschland GmbH
Technical Information Center
Schatzbogen 7
81829 Muenchen, Germany
+44 1296 380 456 (English)
+46 8 52200080 (English)
+49 89 92103 559 (German)
+33 1 69 35 48 48 (French)
support@freescale.com

Japan:

Freescale Semiconductor Japan Ltd.
Headquarters
ARCO Tower 15F
1-8-1, Shimo-Meguro, Meguro-ku,
Tokyo 153-0064
Japan
0120 191014 or +81 3 5437 9125
support.japan@freescale.com

Asia/Pacific:

Freescale Semiconductor Hong Kong Ltd.
Technical Information Center
2 Dai King Street
Tai Po Industrial Estate
Tai Po, N.T., Hong Kong
+800 2666 8080
support.asia@freescale.com

For Literature Requests Only:

Freescale Semiconductor Literature Distribution Center
P.O. Box 5405
Denver, Colorado 80217
1-800-441-2447 or 303-675-2140
Fax: 303-675-2150
LDCForFreescaleSemiconductor@hibbertgroup.com

Information in this document is provided solely to enable system and software implementers to use Freescale Semiconductor products. There are no express or implied copyright licenses granted hereunder to design or fabricate any integrated circuits or integrated circuits based on the information in this document.

Freescale Semiconductor reserves the right to make changes without further notice to any products herein. Freescale Semiconductor makes no warranty, representation or guarantee regarding the suitability of its products for any particular purpose, nor does Freescale Semiconductor assume any liability arising out of the application or use of any product or circuit, and specifically disclaims any and all liability, including without limitation consequential or incidental damages. "Typical" parameters that may be provided in Freescale Semiconductor data sheets and/or specifications can and do vary in different applications and actual performance may vary over time. All operating parameters, including "Typicals", must be validated for each customer application by customer's technical experts. Freescale Semiconductor does not convey any license under its patent rights nor the rights of others. Freescale Semiconductor products are not designed, intended, or authorized for use as components in systems intended for surgical implant into the body, or other applications intended to support or sustain life, or for any other application in which the failure of the Freescale Semiconductor product could create a situation where personal injury or death may occur. Should Buyer purchase or use Freescale Semiconductor products for any such unintended or unauthorized application, Buyer shall indemnify and hold Freescale Semiconductor and its officers, employees, subsidiaries, affiliates, and distributors harmless against all claims, costs, damages, and expenses, and reasonable attorney fees arising out of, directly or indirectly, any claim of personal injury or death associated with such unintended or unauthorized use, even if such claim alleges that Freescale Semiconductor was negligent regarding the design or manufacture of the part.

Freescale™ and the Freescale logo are trademarks of Freescale Semiconductor, Inc. All other product or service names are the property of their respective owners.
© Freescale Semiconductor, Inc. 2006. All rights reserved.

RoHS-compliant and/or Pb-free versions of Freescale products have the functionality and electrical characteristics of their non-RoHS-compliant and/or non-Pb-free counterparts. For further information, see <http://www.freescale.com> or contact your Freescale sales representative.

For information on Freescale's Environmental Products program, go to <http://www.freescale.com/epp>.

Looking for pricing, stock, or lifecycle information?

Click below to explore more details on WIN SOURCE:

- ⊖ [View MHVIC915NR2 on WIN SOURCE](#)
- ⊖ [Freescale Semiconductor - NXP Information](#)

Optimize Your Supply Chain with WIN SOURCE Solutions

- ✓ Global Sourcing Solution
- ✓ Obsolete Management
- ✓ Cost Control Management
- ✓ Shortage Management
- ✓ Alternative Solution
- ✓ Excess Inventory Management