



**THE DATASHEET OF
MEA3216P211RT301**



3-terminal Filters(SMD Array) For General Signal Line

Conformity to RoHS Directive

MEA Series MEA3216L Type

FEATURES

- Own unique 4-line multilayer L-type 3-terminal filter array.
- Tape packaging allows use by automatic assembly equipment.
- Entirely monolithic structure is almost unaffected by crosstalk.

APPLICATIONS

RGB and signal lines of data terminals, computing and communications devices, color liquid crystal displays, printers, DVDs, electronic games, portable audio-visual equipment, etc.

TEMPERATURE RANGES

Operating/Storage	-40 to +85°C
-------------------	--------------

PRODUCT IDENTIFICATION

MEA	3216	L	50R0	T
(1)	(2)	(3)	(4)	(5)

- (1)Series name (4)Cutoff frequency (MHz)
 (2)Dimensions L×W 50R0:fc=50MHz
 (3)L type circuit (5)Packaging style T:Taping

PACKAGING STYLE AND QUANTITIES

Packaging style	Quantity
Taping	2000 pieces/reel

SHAPES AND DIMENSIONS/CIRCUIT DIAGRAM/RECOMMENDED PC BOARD PATTERN

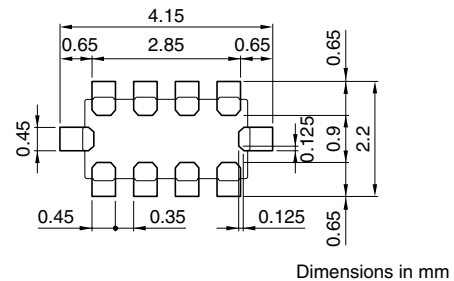
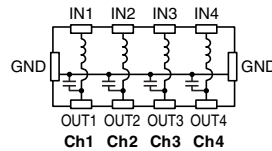
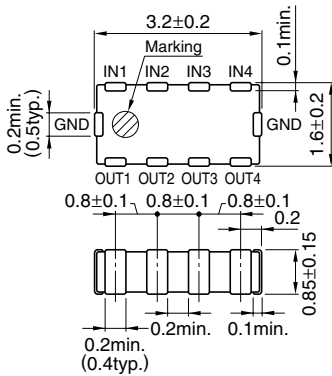

Weight: 26mg
 Dimensions in mm

ELECTRICAL CHARACTERISTICS

Part No.	Cutoff frequency (MHz)typ.	Attenuation 20dB frequency range (MHz)	Rated voltage (V)max.	Rated current (mA)max.
MEA3216L25R0	25	300 to 1000	10	100
MEA3216L50R0	50	500 to 1000	10	100
MEA3216L75R0	75	500 to 800	10	100
MEA3216L101R	100	500 to 600	10	100

TEST EQUIPMENT

- HP-8753B NETWORK ANALYZER, or equivalent
- HP-85046A S-PARAMETER TEST SET, or equivalent

TYPICAL ELECTRICAL CHARACTERISTICS

ATTENUATION vs. FREQUENCY CHARACTERISTICS

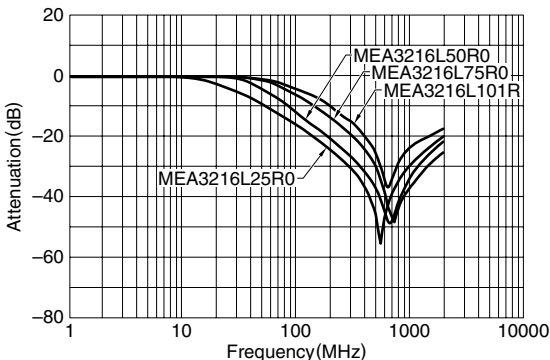

MEA3216L50R0: Crosstalk(50Ω System)

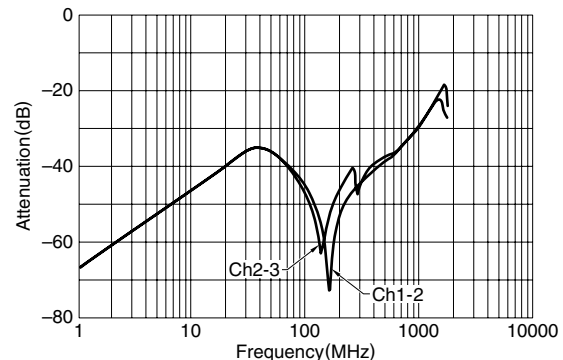

- Conformity to RoHS Directive: This means that, in conformity with EU Directive 2002/95/EC, lead, cadmium, mercury, hexavalent chromium, and specific bromine-based flame retardants, PBB and PBDE, have not been used, except for exempted applications.
- Please contact our Sales office when your application are considered the following:
 The device's failure or malfunction may directly endanger human life (e.g. application for automobile/aircraft/medical/nuclear power devices, etc.)

• All specifications are subject to change without notice.

RECOMMENDED SOLDERING CONDITION REFLOW SOLDERING

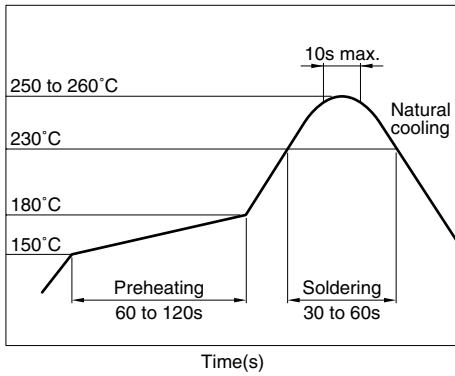

TYPICAL APPLICATIONS

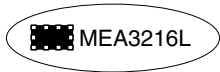

Multilayer chip bead

- MPZ2012 Large current type for power line
- MMZ1608 Large current type for signal line

EMC of RGB signal lines of
TFT color liquid crystal displays

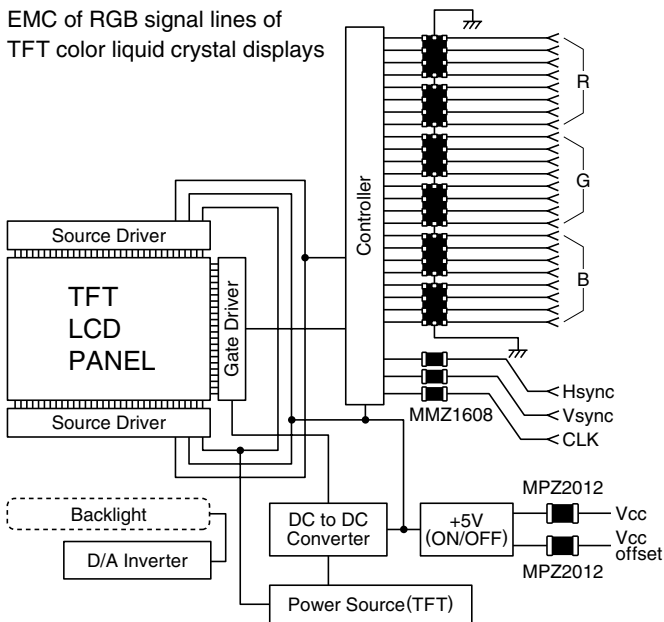

Looking for pricing, stock, or lifecycle information?

Click below to explore more details on WIN SOURCE:

- ⊖ [View MEA3216P211RT301 on WIN SOURCE](#)
- ⊖ [TDK Corporation Information](#)

Optimize Your Supply Chain with WIN SOURCE Solutions

- ✓ Global Sourcing Solution
- ✓ Obsolete Management
- ✓ Cost Control Management
- ✓ Shortage Management
- ✓ Alternative Solution
- ✓ Excess Inventory Management