

DiskOnChip 2000 DIP

From 16MByte to 1GByte

Data Sheet, September 2004

Highlights

DiskOnChip 2000 DIP is a member of M-Systems' family of DiskOnChip flash disk products. It is available in capacities of 16MByte to 1GByte.

DiskOnChip 2000 DIP features:

- Single-chip plug-n-play flash disk
- Low power, single 3.3V or 5V power supply
- 16MByte (MB) to 1GByte (GB) capacity
- Simple, easy-to-integrate interface
- 8KB sized memory window
- Boot OS capability
- Proprietary TrueFFS[®] technology for full hard-disk emulation, high data reliability and maximum flash lifetime
- Software tools for programming, duplicating, testing, and debugging

Reliability

- On-the-fly Reed-Solomon Error Detection Code/Error Correction Code (EDC/ECC)
- Guaranteed data integrity, even after power failure
- Transparent bad-block management
- Dynamic and static wear-leveling



TrueFFS Software

- Full hard-disk read/write emulation for transparent file system management
- Identical software for all DiskOnChip capacities
- Patented methods to extend flash lifetime, including:
 - Dynamic virtual mapping
 - Dynamic and static wear-leveling
- Support for all major OSs, including: VxWorks, Windows CE/.NET, Linux, Windows NT/XP, QNX and others.
- Operates with TrueFFS Software Development Kit (SDK) in OS-less environment.

Hardware Compatibility

- 32-pin DIP, JEDEC standard, EEPROM-compatible pinout
- Pinout compatible with DiskOnChip Millennium DIP 8MB
- Compatible with all major CPUs, including:
 - x86
 - StrongARM
 - XScale
 - Geode[®] SCxxxx
 - PowerPC[™] MPC8xx
 - MediaGX
 - 68K
 - MIPS
 - SuperH[™] SH-x
- 8-bit, 16-bit and 32-bit bus architecture support

Applications

- Embedded systems
- Internet access devices
- Internet set-top boxes/ITV, Web browsers
- WBT, thin clients, network computers
- Routers, networking
- Web phones, car PCs, DVD, HPC
- Point of sale, industrial PCs
- Telecom, medical

Capacities

- Low profile: 16, 24, 32, 48, 64, 96, 128, 192, 256, 384MB
- High profile: 576, 768, 1024MB
- Commercial (0°C to 70°C) and Extended Temperature Range (-40°C to +85°C) for all capacities

TABLE OF CONTENTS

1. Introduction	3
2. Product Overview	4
2.1 Product Description	4
2.2 I/O Operation	5
2.3 Pin Diagram.....	5
2.4 Signal Descriptions.....	6
3. Theory of Operation	7
3.1 Overview.....	7
3.2 System Interface.....	7
3.3 Boot Block	8
3.4 Error Detection Code/Error Correction Code (EDC/ECC)	8
3.5 Flash Control	8
4. Operating Modes	9
5. TrueFFS Technology.....	10
5.1 General Description.....	10
5.1.1 Built-In Operating System Support.....	11
5.1.2 TrueFFS Software Development Kit (SDK).....	11
5.1.3 File Management.....	11
5.1.4 Bad-Block Management	11
5.1.5 Wear-Leveling	11
5.2 Power Failure Management	12
5.2.1 Error Detection/Correction.....	12
5.2.2 Special Features through I/O Control (IOCTL) Mechanism	13
5.2.3 Compatibility	13
5.3 8KB Memory Window	14
6. Booting from DiskOnChip 2000	15
6.1 Introduction.....	15
6.2 Boot Procedure in PC-Compatible Platforms	15
7. Design Considerations	17
7.1 Design Environment	17
7.2 System Interface.....	17
7.3 Connecting Signals.....	18
7.4 Platform-Specific Issues	18

7.4.1	Wait State	18
7.4.2	Big and Little Endian Systems.....	18
7.4.3	Working with 8/16/32-Bit Systems.....	19
8.	Product Specifications	20
8.1	Environmental Specifications	20
8.1.1	Temperature Ranges	20
8.1.2	DiskOnChip Assembly.....	20
8.1.3	Humidity.....	20
8.1.4	Shock and Vibration	20
8.2	Electrical Specifications.....	20
8.2.1	Absolute Maximum Ratings.....	20
8.2.2	Capacitance.....	21
8.2.3	DC Electrical Characteristics over Operating Range	21
8.2.4	AC Operating Conditions.....	22
8.3	Timing Specifications.....	23
8.3.1	Read Cycle Timing	23
8.3.2	Write Cycle Timing	24
8.4	Mechanical Dimensions.....	25
9.	Ordering Information.....	26
	How to Contact Us	27

1. INTRODUCTION

This data sheet includes the following sections:

- Section 1:** Overview of data sheet contents
- Section 2:** Product overview, including brief product description, a pin diagram and signal descriptions
- Section 3:** Theory of operation for the major building blocks
- Section 4:** Modes of operation
- Section 5:** Description of TrueFFS technology
- Section 6:** Using DiskOnChip 2000 DIP as a boot device
- Section 7:** Design considerations for implementing popular applications and for maximizing built-in flexibility features
- Section 8:** Environmental, mechanical, electrical and production specifications

To contact M-Systems' worldwide offices for general information and technical support, please see the listing on the back page, or visit M-Systems' website (www.m-systems.com).

2. PRODUCT OVERVIEW

2.1 Product Description

The DiskOnChip 2000 product line is the second-generation of M-Systems' DiskOnChip series of products. The DiskOnChip 2000 series provides a small, single-chip, solid-state flash disk in a standard 32-pin DIP package. Combining a disk controller with flash memory on a single chip, DiskOnChip 2000 is *the* solution where minimal weight, space, and power consumption are essential. DiskOnChip 2000 is used in a wide range of products, such as information appliances, set-top boxes, thin clients, thin servers, network computers, and embedded, portable computers.

By placing DiskOnChip 2000 in a standard socket, physical space requirements are reduced. Unlike standard IDE drives, no cables or extra space are required. DiskOnChip 2000 has no moving parts, resulting in significantly decreased power consumption and increased reliability. It is easy to use and reduces integration overhead. DiskOnChip 2000 is therefore a very attractive alternative to conventional hard and floppy disk drives.

Using TrueFFS technology, DiskOnChip 2000 delivers full hard disk emulation. As such, the design and integration stages can be considerably reduced, thereby enabling very fast time-to-market and ease of production. Combined with its very attractive cost structure, DiskOnChip 2000 is a superior alternative to resident flash array (RFA).

DiskOnChip 2000 products are available in capacities ranging from 16MB to 1GB. DiskOnChip technology provides broad support for all major operating systems and processors in the market, enabling it to be readily integrated with any architecture.

DiskOnChip 2000 is shipped as a plug-and-play device that is fully tested and formatted, and programmed with a DOS driver. Future driver, software or content upgrades, or formatting, can be made on-board or off-board using DiskOnChip utilities and accessories provided by M-Systems.

2.2 I/O Operation

See Figure 1 for a simplified I/O diagram.

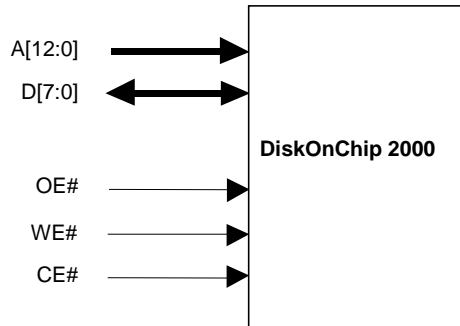

Figure 1: Simplified I/O Diagram

2.3 Pin Diagram

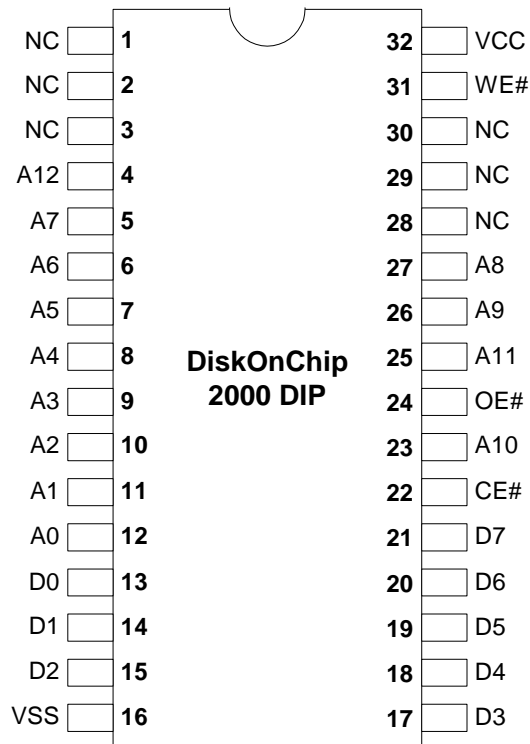

Figure 2: Package Description and Pinout

2.4 Signal Descriptions

Table 1: DiskOnChip 2000 Signal Descriptions

Signal	Pin Number	Input Type	Description	Signal Type
System Interface				
A[12:0]	4 to 12, 23, 25 to 27	ST	Address signals	Input
D[7:0]	13 to 15, 17 to 21	IN	Data signals	Input/Output
CE#	22	ST	Chip Enable, active low	Input
OE#	24	ST	Output Enable, active low	Input
WE#	31	ST	Write Enable, active low	Input
Power				
VCC	32	-	Device supply	Supply
VSS	16	-	Ground	Supply
Other				
NC	1, 2, 3, 28, 29, 30	-	Not Connected. These pins should be left floating. Absolute maximum ratings must be observed.	

The following abbreviations are used:

1. IN: Standard (non-Schmidt) input
2. ST: Schmidt Trigger input

3. THEORY OF OPERATION

3.1 Overview

DiskOnChip 2000 consists of the following major functional blocks, as shown in Figure 3:

- **System Interface** for host interface.
- **Boot Block** that contains IPL ROM required for recognition during BIOS expansion search in PC architectures.
- Reed-Solomon-based **Error Detection and Error Correction Code (EDC/ECC)** for on-the-fly error handling.
- **Flash Control block** that contains registers responsible for transferring the address, data and control information between the TrueFFS driver and the flash media.

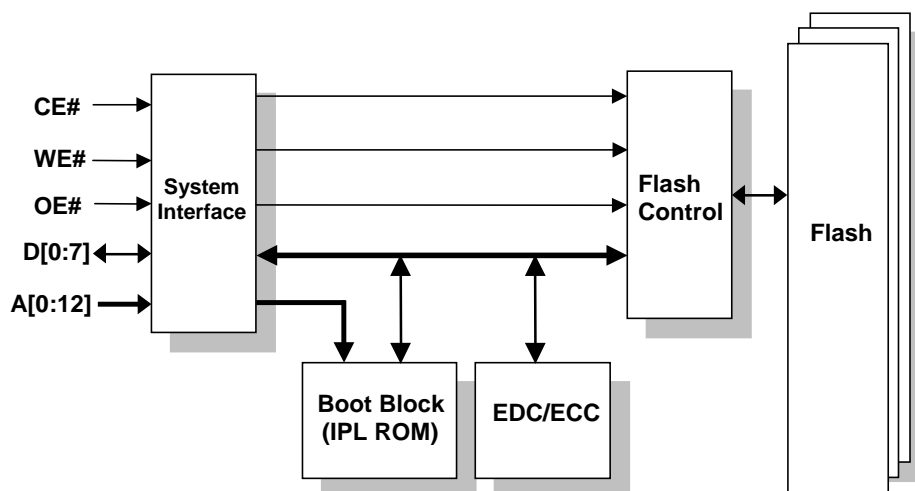

Figure 3: DiskOnChip 2000 Simplified Block Diagram

3.2 System Interface

The system interface block provides an easy-to-integrate SRAM-like (also EEPROM-like) interface to DiskOnChip 2000, enabling it to interface with various CPU interfaces, such as a local bus, ISA bus, SRAM interface, EEPROM interface or any other compatible interface.

A 13-bit wide address bus enables access to the DiskOnChip 8KB memory window (as shown in Figure 5). The Chip Enable (CE#), Write Enable (WE#) and Output Enable (OE#) signals trigger read and write cycles. A write cycle occurs while both the CE# and the WE# inputs are asserted. Similarly, a read cycle occurs while both the CE# and OE# inputs are asserted. Note that DiskOnChip 2000 does not require a clock signal. The CE#, WE# and OE# signals trigger the controller (e.g., system interface block, bus control and data pipeline) and flash access.

3.3 Boot Block

The boot block is responsible for answering the BIOS expansion search in PC architectures. After the BIOS identifies DiskOnChip 2000 as a valid BIOS expansion device, it executes the code stored in the boot block. The BIOS then loads the TrueFFS software from the flash memory into the host memory, delivering full disk capabilities to the operating system. This code is identical for all DiskOnChip 2000 capacities, since TrueFFS automatically detects the memory capacity of DiskOnChip 2000.

3.4 Error Detection Code/Error Correction Code (EDC/ECC)

NAND flash, being an imperfect memory, requires error handling. DiskOnChip 2000 implements Reed-Solomon Error Detection Code (EDC). A hardware-generated, 6-byte error detection signature is computed each time a page (512 bytes) is written to or read from DiskOnChip 2000.

The TrueFFS driver implements complementary Error Correction Code (ECC). Unlike error detection, which is required on every cycle, error correction is relatively seldom required, hence implemented in software. The combination of DiskOnChip's built-in EDC mechanism and the TrueFFS driver ensures highly reliable error detection and correction, while providing maximum performance.

The following detection and correction capability is provided for each 512 bytes:

- Corrects up to two 10-bit symbols, including two random bit errors.
- Corrects single bursts up to 11 bits.
- Detects single bursts up to 31 bits and double bursts up to 11 bits.
- Detects up to 4 random bit errors.

3.5 Flash Control

The Flash Control block contains registers responsible for transferring the address, data and control information between the DiskOnChip TrueFFS driver and the flash media. Additional registers are used to monitor the status of the flash media (ready/busy) and of the DiskOnChip controller.

4. OPERATING MODES

DiskOnChip 2000 can operate in two modes:

- Normal: The device responds to every valid hardware cycle. While in this mode, all sections respond to valid read and write cycles.
- Reset: The device ignores all write cycles (except for the “leave Reset mode” sequence), and returns predetermined values for all read cycles.

Mode changes can occur due to any of the following events:

- o A valid write sequence to the Control register
- o Triggering the Boot Detector circuit, which enables automatic driver loading in a PC environment.

5. TRUEFFS TECHNOLOGY

5.1 General Description

M-Systems' patented TrueFFS technology was designed to maximize the benefits of flash memory while overcoming inherent flash limitations that would otherwise reduce its performance, reliability and lifetime. TrueFFS emulates a hard disk, making it completely transparent to the OS. In addition, since it operates under the OS file system layer (see Figure 4), it is completely transparent to the application.

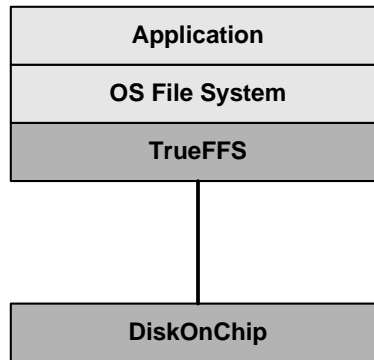

Figure 4: TrueFFS Location in System Hierarchy

TrueFFS technology support includes:

- Binary driver support for all major OSs
- TrueFFS Software Development Kit (SDK)
- Boot Software Development Kit (BDK)
- Support for all major CPUs, including 8-, 16- and 32-bit bus architectures

TrueFFS technology features:

- Block device API
- Flash file system management
- Bad-block management
- Dynamic virtual mapping
- Dynamic and static wear-leveling
- Power failure management
- Implementation of Reed-Solomon EDC/ECC
- Performance optimization
- Compatible with all DiskOnChip products

5.1.1 Built-In Operating System Support

The TrueFFS driver is integrated into all major OSs, including: Windows CE/NT/NT Embedded/XP, Linux (various kernels), VxWorks, Nucleus, QNX, DOS, Symbian, and others. For a complete listing of all available drivers, please refer to M-Systems' website www.m-systems.com. It is advised to use the latest driver versions that can be downloaded from the DiskOnChip 2000 web page on the M-Systems site.

5.1.2 TrueFFS Software Development Kit (SDK)

The basic *TrueFFS Software Development Kit (SDK)* provides the source code of the TrueFFS driver. It can be used in an OS-less environment or when special customization of the driver is required for proprietary OSs.

5.1.3 File Management

TrueFFS accesses the flash memory within DiskOnChip 2000 through an 8KB window in the CPU memory space. It provides block device API, by using standard file system calls, identical to those used by a mechanical hard disk, to enable reading from and writing to any sector on DiskOnChip 2000. This makes it compatible with any file system and file system utilities such as diagnostic tools and applications. When using the File Allocation Table (FAT) file system, the data stored on DiskOnChip 2000 uses FAT-16.

Note: DiskOnChip 2000 is shipped formatted, and contains the FAT file system.

5.1.4 Bad-Block Management

NAND flash, being an imperfect storage media, contains some bad blocks that cannot be used for storage because of their high error rates. TrueFFS automatically detects and maps bad blocks upon system initialization, ensuring that they are not used for storage. This management process is completely transparent to the user, who remains unaware of the existence and location of bad blocks, while remaining confident of the integrity of data stored. The Bad Block Table in DiskOnChip 2000 DIP is stored in a protected area for ensured reliability.

5.1.5 Wear-Leveling

Flash memory can be erased a limited number of times. This number is called the *erase cycle limit* or *write endurance limit* and is defined by the flash array vendor. The erase cycle limit applies to each individual erase block in the flash device. After reaching the cycle limit, as given by the flash vendor, the erase block begins to make storage errors at a rate significantly higher than the error rate that is typical to the flash.

In a typical application and especially if a file system is used, a specific page or pages are constantly updated (e.g., the page/s that contain the FAT, registry etc.). Without any special handling, these pages would wear out more rapidly than other pages, reducing the lifetime of the entire flash.

To overcome this inherent deficiency, TrueFFS uses M-Systems' patented wear-leveling algorithm. The wear-leveling algorithm ensures that consecutive writes of a specific sector are not written physically to the same page in the flash. This spreads flash media usage evenly across all pages, thereby maximizing flash lifetime. TrueFFS wear-leveling extends the flash lifetime 10 to 15 years beyond the lifetime of a typical application.

Dynamic Wear-Leveling

TrueFFS uses statistical allocation to perform dynamic wear-leveling on newly written data. This not only minimizes the number of erase cycles per block, it also minimizes the total number of erase cycles. Because a block erase is the most time-consuming operation, dynamic wear-leveling has a major impact on overall performance. This impact cannot be noticed during the first write to flash (since there is no need to erase blocks beforehand), but it is more and more noticeable as the flash media becomes full.

Static Wear-Leveling

Areas on the flash media may contain static files, characterized by blocks of data that remain unchanged for very long periods of time, or even for the whole device lifetime. If wear-leveling were only applied on newly written pages, static areas would never be cycled. This limited application of wear-leveling would lower life expectancy significantly in cases where flash memory contains large static areas. To overcome this problem, TrueFFS forces data transfer in static areas as well as in dynamic areas, thereby applying wear-leveling to the entire media.

5.2 Power Failure Management

TrueFFS uses algorithms based on “erase after write” instead of “erase before write” to ensure data integrity during normal operation and in the event of a power failure. Used areas are reclaimed for erasing and writing the flash management information into them only *after* an operation is complete. This procedure serves as a check on data integrity.

The “erase after write” algorithm is also used to update and store mapping information on the flash memory. This keeps the mapping information coherent even during power failures. The only mapping information held in RAM is a table pointing to the location of the actual mapping information. This table is reconstructed during power-up or after reset from the information stored in the flash memory.

To prevent data from being lost or corrupted, TrueFFS uses the following mechanisms:

- When writing, copying, or erasing the flash device, the data format remains valid at all intermediate stages. Previous data is never erased until the operation has been completed and the new data has been verified.
- A data sector cannot exist in a partially written state. Either the operation is successfully completed, in which case the new sector contents are valid, or the operation has not yet been completed or has failed, in which case the old sector contents remain valid.

5.2.1 Error Detection/Correction

TrueFFS implements a Reed-Solomon Error Correction Code (ECC) algorithm to ensure data reliability. Refer to Section 3.4 for further information on the EDC/ECC mechanism.

5.2.2 Special Features through I/O Control (IOCTL) Mechanism

In addition to standard storage device functionality, the TrueFFS driver provides extended functionality. This functionality goes beyond simple data storage capabilities to include features such as: format the media, binary partition(s) access, flash defragmentation, and other options. This unique functionality is available in all TrueFFS-based drivers through the standard I/O control command of the native file system.

For further information, please refer to application note AP-DOC-046, *Extended Functions of the TrueFFS Driver for DiskOnChip*.

5.2.3 Compatibility

The TrueFFS driver supports all released DiskOnChip products. Upgrading from one product to another requires no additional software integration.

When using different drivers (e.g. TrueFFS SDK, BDK, BIOS extension firmware, etc.) to access DiskOnChip, the user must verify that all software is based on the same code base version. It is also important to use only tools (e.g. DFORMAT, DINFO, GETIMAGE, etc.) derived from the same version as the firmware version and the TrueFFS drivers used in the application. Failure to do so may lead to unexpected results, such as lost or corrupted data. The driver and firmware version can be verified by the sign-on messages displayed, or by the version information stored in the driver or tool.

5.3 8KB Memory Window

The DiskOnChip 2000 memory map occupies a total address space of 8KB. This space consists of four 2KB sections, as shown in Figure 5 and described below.

- Section 0: Boot Block**
 This section includes data that is typically used for booting code from the CPU. The available size is 64 bytes, aliased 32 times in the 2KB section. The second half of the boot block is located in Section 2.
- Section 1: Boot Block**
 This section includes the second 64 bytes of the Boot Block. The first 64 bytes can be found in Section 0, aliased 32 times.
- Section 2: Control Registers**
 Used to control the behavior of DiskOnChip 2000 and the flash media.
- Section 3: Flash Area Window**
 Used as a window to the flash media for data to be written or read.

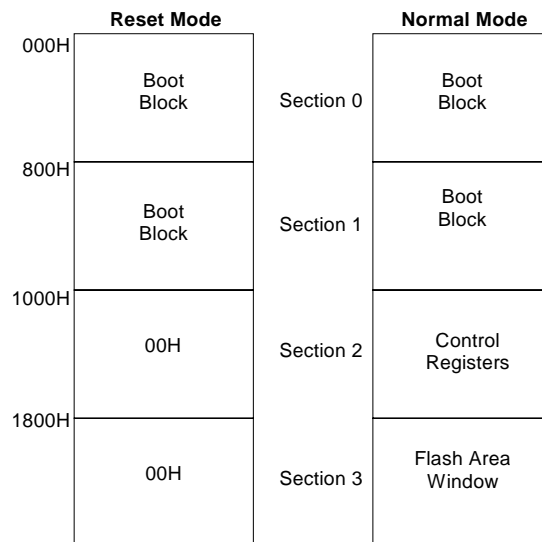

Figure 5: DiskOnChip 2000 Memory Map

6. BOOTING FROM DISKONCHIP 2000

6.1 Introduction

DiskOnChip 2000 can operate as the OS boot device. The DiskOnChip default firmware contains drivers to enable it to perform as the OS boot device under DOS. For other OSs, please refer to the TrueFFS driver *readme* file.

6.2 Boot Procedure in PC-Compatible Platforms

When used in PC-compatible platforms, DiskOnChip 2000 is connected to an 8KB memory window in the BIOS expansion memory range, typically located between 0C8000H to 0EFFFFH. During the boot process, the BIOS loads the TrueFFS firmware into the PC memory and installs DiskOnChip 2000 as a disk drive in the system. When the operating system is loaded, DiskOnChip 2000 is recognized as a standard disk. No external software is required to boot from DiskOnChip 2000. Figure 6 illustrates the location of the DiskOnChip 2000 memory window in the PC memory map.

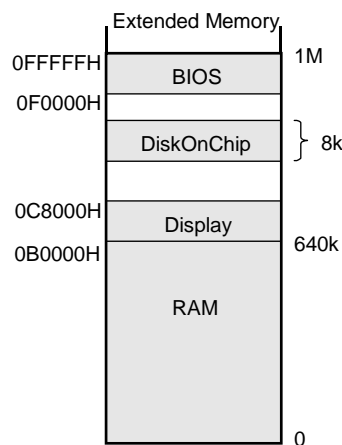

Figure 6: DiskOnChip 2000 Memory Window in the PC Memory Map

After reset, the BIOS code first executes the Power On Self-Test (POST) and then searches for all expansion ROM devices. When DiskOnChip 2000 is found, the BIOS code executes from it the IPL (Initial Program Loader) code, located in the boot block. This code loads the TrueFFS driver into system memory, installs DiskOnChip 2000 as a disk in the system, and then returns control to the BIOS code. The operating system subsequently identifies DiskOnChip 2000 as an available disk. TrueFFS responds by emulating a hard disk.

From this point onward, DiskOnChip 2000 appears as a standard disk drive. It is assigned a drive letter and can be used by any application, without any modifications to either the BIOS set-up or the autoexec.bat/config.sys files. DiskOnChip 2000 can be used as the only disk in the system, with or without a floppy drive, and with or without hard disks.

The drive letter assigned depends on how DiskOnChip 2000 is used in the system, as follows:

- If DiskOnChip 2000 is used as the only disk in the system, the system boots directly from it and assigns it drive C.
- If DiskOnChip 2000 is used with other disks in the system:
 - o DiskOnChip 2000 can be configured as the last drive (the default configuration). The system assigns drive C to the hard disk and drive D to DiskOnChip 2000.
 - o Alternatively, DiskOnChip 2000 can be configured as the system's first drive. The system assigns drive D to the hard disk and drive C to DiskOnChip 2000.
- If DiskOnChip 2000 is used as the OS boot device when configured as drive C, it must be formatted as a bootable device by copying the OS files onto it. This is done by using the SYS command when running DOS.

7. DESIGN CONSIDERATIONS

7.1 Design Environment

DiskOnChip 2000 provides a complete design environment consisting of:

- Evaluation Boards (EVBs) for enabling software integration and development with DiskOnChip 2000, even before the target platform is available. An EVB with an ISA standard connector and a PCI standard connector for immediate plug and play usage are available.
- Programming solutions:
 - o GANG programmer
 - o Programming house
 - o On-board programming
- TrueFFS Software Development Kit (SDK) and BDK
- DOS utilities:
- DFORMAT
- GETIMG/PUTIMG
- DINFO
- Documentation:
 - o Data Sheet
 - o Application Notes
 - o Technical Notes
 - o Articles
 - o White Papers

Please visit M-Systems' website (www.m-systems.com) for the most updated documentation, utilities and drivers.

7.2 System Interface

DiskOnChip 2000 uses an SRAM-like interface that can easily be connected to any microprocessor bus. With a standard interface, it requires 13 address lines, 8 data lines and basic memory control signals (CE#, OE#, WE#), as shown in Figure 7 below. Typically, DiskOnChip 2000 can be mapped to any free 8KB memory space. In a PC-compatible platform, it is usually mapped into the BIOS expansion area. If the allocated memory window is larger than 8KB, an automatic anti-aliasing mechanism prevents the firmware from being loaded more than once during the ROM expansion search.

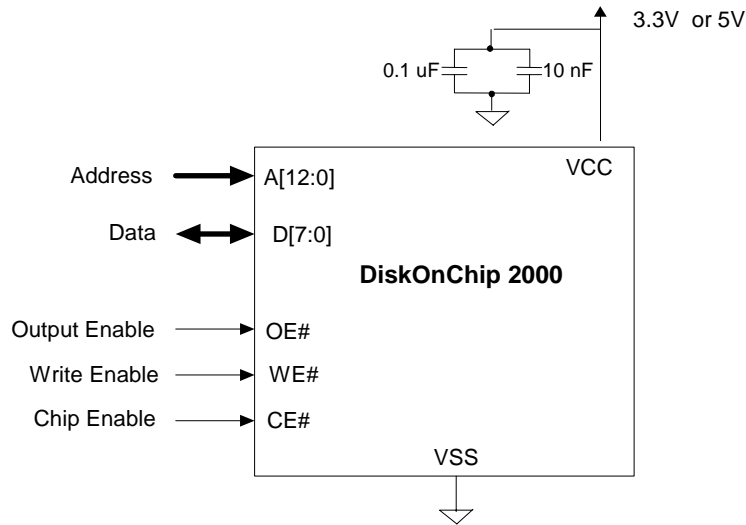

Figure 7: DiskOnChip 2000 System Interface

- Notes:
1. The 0.1 μF and the 10 nF low-inductance high-frequency capacitors must be attached to each of the device's VCC and VSS pins.
 2. DiskOnChip 2000 is an edge-sensitive device. CE#, OE# and WE# should be properly terminated (according to board layout, serial parallel, or both terminations) to avoid signal ringing.

7.3 Connecting Signals

DiskOnChip 2000 uses standard SRAM-like control signals, which should be connected as follows:

- Address (A[12:0]) – Connect these signals to the host address bus.
- Data (D[7:0]) – Connect these signals to the host data bus.
- Write (WE#) and Output Enable (OE#) – Connect these signals to the host WR# and RD# signals, respectively.
- Chip Enable (CE#) – Connect this signal to the memory address decoder.

7.4 Platform-Specific Issues

The following section describes hardware design issues.

7.4.1 Wait State

Wait states can be implemented only when DiskOnChip 2000 is designed in a bus that supports a Wait state insertion, and supplies a WAIT signal.

7.4.2 Big and Little Endian Systems

PowerPC, ARM, and other RISC processors can use either Big or Little Endian systems.

DiskOnChip 2000 uses the Little Endian system. Therefore, byte D[7:0] is its Least Significant Byte (LSB); bit D0 is the least significant bit within that byte. When connecting DiskOnChip 2000 to a

device that supports Big Endian systems, make sure to that the bytes of the CPU and DiskOnChip 2000 match.

Note: Processors, such as the PowerPC, also change the bit ordering within the bytes. Failing to follow these rules results in improper connection of DiskOnChip 2000, and prevents the TrueFFS driver from identifying DiskOnChip 2000.

7.4.3 Working with 8/16/32-Bit Systems

The TrueFFS driver supports 8-bit, 16-bit, and 32-bit bus architectures. Support for the 16-bit and 32-bit bus architectures, typically used in RISC processors, can be achieved by using the LSB of the data bus as follows:

- For 16-bit address boundary shifts, shift the address lines by *one*, so that the host address line A1 connects to DiskOnChip 2000 address line A0, the host address line A2 connects to DiskOnChip 2000 line A1, and so on.
- For 32-bit address boundary shifts, shift the address lines by *two*, so that the host address line A2 connects to DiskOnChip 2000 address line A0, the host address line A3 connects to DiskOnChip 2000 line A1, and so on.

8. PRODUCT SPECIFICATIONS

8.1 Environmental Specifications

8.1.1 Temperature Ranges

- Commercial operating temperature: 0°C to +70°C
- Extended operating temperature: -40°C to +85°C
- Storage temperature: -50°C to +85°C

8.1.2 DiskOnChip Assembly

The DiskOnChip 2000 DIP device is not hermetically sealed. Therefore, it must be assembled after the PCB goes through its final rinse. Assembling DiskOnChip 2000 prior to the rinse phase may cause it to absorb moisture. Failure to adhere to the above assembly instruction can lead to device failures not covered by M-Systems' warranty.

Note: DiskOnChip 2000 DIP requires a DIP socket on the target platform. Due to its plastic shell and molding material, it cannot be soldered directly to the platform.

8.1.3 Humidity

10% - 90% relative, non-condensing

8.1.4 Shock and Vibration

Table 2: Reliability Tests

Reliability Test	Test Conditions	Reference Standard
Vibration	100 ~ 2000 Hz, 15 G peak, 3 cycles per axis (1hr.), 3 axes	STD-202F, Method 204D
Mechanical Shock	Half-sine shock 50 G, 11 msec, ± 3 shocks per axis, 3 axes	STD-202F, Method 213B

8.2 Electrical Specifications

8.2.1 Absolute Maximum Ratings

Table 3: Maximum Ratings

Parameter	Symbol	3.3V Model Rating ¹	5V Model Rating ¹	Units	Notes
DC supply voltage	V_{CCS}	-0.5 to 4.6	-0.3 to 6.0	V	
Input pin voltage ²	V_{IN}	-0.5 to $V_{CC} + 0.3$	-0.3 to $V_{CC} + 0.3$	V	
Input pin current	I_{IN}	Not Specified	-10 to 10	mA	+25°C
Power Dissipation	PD	1.3	2.0	Watt	

1. The voltage on any pin may undershoot to -2.0V or overshoot to $V_{CC}+2.0V$ for periods <20 ns.
2. The unit shall be supplied from limited power source, which meets the requirements, detailed in clause 2.5 of UL 60950-1.
3. Permanent device damage may occur if absolute maximum ratings are exceeded. Exposure to absolute maximum rating conditions for extended periods may affect device reliability.

In order to protect DiskOnChip 2000 when it is exposed to overcurrent, a fuse may be added, or modifications to the power supply's overcurrent protection mechanism may be considered.

Figure 8 illustrates the suggested overcurrent protection for DiskOnChip 2000.

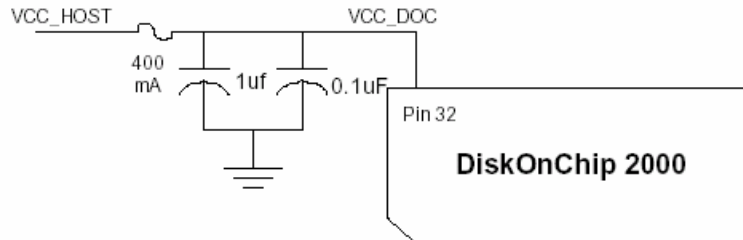

Figure 8: Protecting DiskOnChip 2000 from Overcurrent

8.2.2 Capacitance

Table 4: Input/Output Capacitance

Symbol	Parameter	Conditions	3.3V Model Rating	5V Model Rating	Unit
$C_{I/O}$	Input/Output Capacitance	MD2200/2, $V_{IN} = 0V$	12	15	pF
		MD2203, $V_{IN} = 0V$	36	45	pF

Note: Capacitance is not 100% tested.

8.2.3 DC Electrical Characteristics over Operating Range

Table 5: $V_{CC} = 5V$ Characteristics

Symbol	Parameter	Conditions	Min	Typ	Max	Unit
V_{CCS}	System Supply Voltage ¹		4.5	5.0	5.5	V
V_{ih}	High-level Input Voltage		2.0			V
V_{il}	Low-level Input Voltage				0.8	V
V_{oh}	High-level Output Voltage	$I_{OH} = -16 \text{ mA}$	2.4			V
V_{OL}	Low-level Output Voltage	$I_{OL} = 16 \text{ mA}$			0.4	V
I_{IL}	Input Leakage Current	MD2200, MD2202			± 10	μA
		MD2203			± 30	μA
I_{OZ}	Output Leakage Current	MD2200, MD2202			± 10	μA
		MD2203			± 30	μA
I_{VCC}	Supply Current	200 ns Cycle Time, outputs open		40	60	mA
I_{stdby}	Standby Current	MD2200, MD2202		60	400	μA
		MD2203		240	1200	μA

Note: The supply voltage of the extended temperature products listed below is $V_{CC} = 5V \pm 0.25V$:
MD2202-D192-X, MD2202-D256-X, MD2202-D384-X, MD2203-D576-X, MD2203-D768-X, MD2203-D1024-X

Table 6: $V_{CC} = 3.3V$ Characteristics

Symbol	Parameter	Conditions	Min	Typ	Max	Unit
V_{CCS}	System Supply Voltage ¹		3.0	3.3	3.6	V
V_{ih}	High-level Input Voltage		2.7			V
V_{il}	Low-level Input Voltage				0.6	V
V_{HYS}	Input Voltage Hysteresis		1.1		1.5	V
V_{oh}	High-level Output Voltage	$I_{OH} = -18\text{ mA}$	2.4			V
		$I_{OH} = 0\text{ mA}$	$V_{CC}-0.1$			V
V_{OL}	Low-level Output Voltage	$I_{OL} = 18\text{ mA}$			0.4	V
		$I_{OL} = 0\text{ mA}$			0.1	V
I_{IL}	Input Leakage Current	MD2200, MD2202			± 10	μA
		MD2203			± 30	μA
I_{OZ}	Output Leakage Current	MD2200, MD2202			± 10	μA
		MD2203			± 30	μA
I_{VCC}	Supply Current	150 ns Cycle Time, outputs open		30	60	mA
I_{stdby}	Standby Current	MD2200, MD2202		70	400	μA
		MD2203		300	1350	μA

Note: The supply voltage of the extended temperature products listed below is $V_{CC} = 3.3V \pm 0.15V$:
MD2202-D192-V3-X, MD2202-D256-V3-X, MD2202-D384-V3-X, MD2203-D576-V3-X, MD2203-D768-V3-X,
MD2203-D1024-V3-X

8.2.4 AC Operating Conditions

Timing specifications are based on the following conditions:

Table 7: AC Operating Conditions

Parameter	3.3V Model	5V Model
Supply Voltage ^{1,2}	$V_{CC} = 3.3V \pm 0.3V$	$V_{CC} = 5V \pm 0.5V$
Input Pulse Levels	0.2V to 2.9V	0.4V to 2.6V
Input Rise and Fall Times	1 ns	5 ns
Input and Output Timing Levels	1.5V	0.8V and 2.0V
Output Load	100 pF	50 pF

Notes: 1. The supply voltage of the extended temperature products listed below is $V_{CC} = 3.3V \pm 0.15V$: MD2202-D192-V3-X, MD2202-D256-V3-X, MD2202-D384-V3-X, MD2203-D576-V3-X, MD2203-D768-V3-X, MD2203-D1024-V3-X

2. The supply voltage of the extended temperature products listed below is $V_{CC} = 5V \pm 0.25V$: MD2202-D192-X, MD2202-D256-X, MD2202-D384-X, MD2203-D576-X, MD2203-D768-X, MD2203-D1024-X

8.3 Timing Specifications

8.3.1 Read Cycle Timing

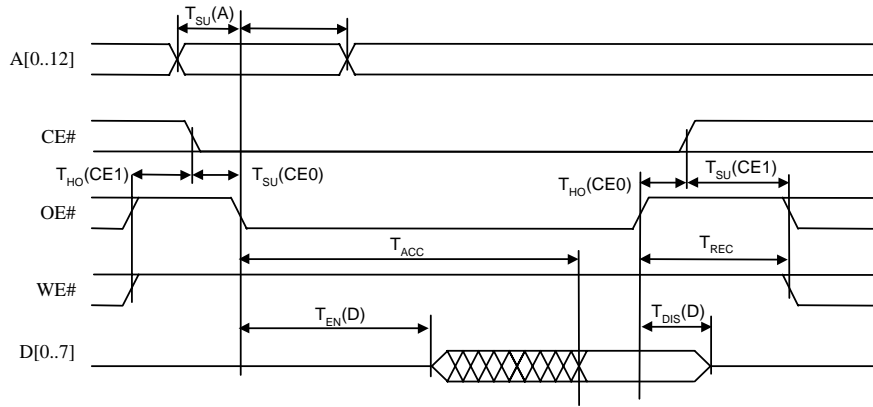

Figure 9: Read Cycle

Table 8: Read Cycle Timing

Symbol	Description	3.3V		5V		Notes
		Min (ns)	Max (ns)	Min (ns)	Max (ns)	
$T_{SU}(A)$	Address to OE# \downarrow setup	2		10		
$T_{HO}(A)$	OE# \downarrow to Address hold	35		56		
$T_{SU}(CE0)$	CE# \downarrow to OE# \downarrow setup	0		0		1
$T_{HO}(CE0)$	OE# \uparrow to CE# = 0 hold	0		0		2
$T_{HO}(CE1)$	OE# or WE# \uparrow to CE# = 1 hold	8		42		
$T_{SU}(CE1)$	CE# \uparrow to WE# or OE# \downarrow setup time	8		42		
T_{REC}	OE# \uparrow to start of next cycle	20		59		
T_{acc}	Read access time		110		130	
$T_{en}(D)$	OE# \downarrow to D active delay	15	75	7	91	
$T_{dis}(D)$	OE# \uparrow to D Hi-Z delay		13		44	

1. CE# may be asserted any time before or after OE# is asserted. If CE# is asserted after OE#, all timing relative to OE# asserted will be referenced instead to the time CE# was asserted.
2. CE# may be negated any time before or after OE# is negated. If CE# is negated before OE#, all timing relative to OE# negated will be referenced instead to the time CE# was negated.

8.3.2 Write Cycle Timing

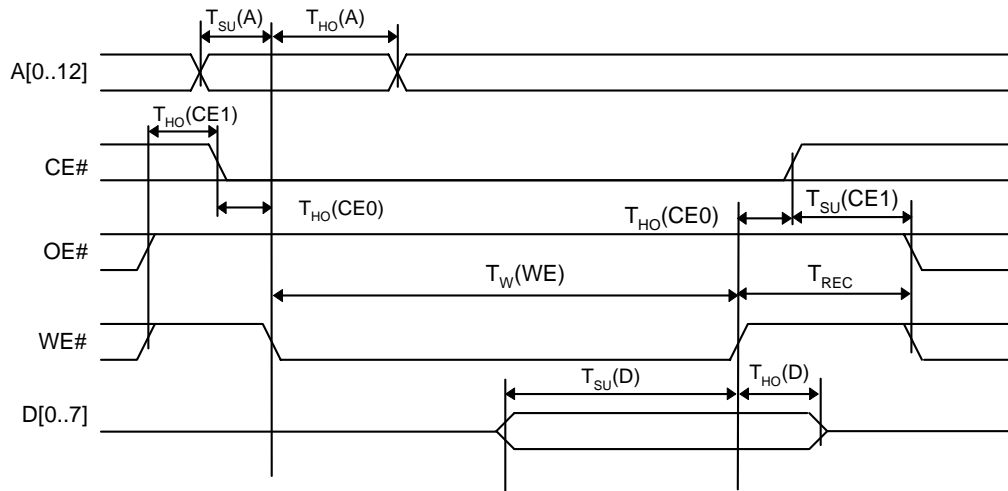

Figure 10: Write Cycle

Table 9: Write Cycle Timing

Symbol	Description	3.3V		5V		Notes
		Min (ns)	Max (ns)	Min (ns)	Max (ns)	
$T_{SU}(A)$	Address to WE# \downarrow setup time	0		10		
$T_{HO}(A)$	WE# \downarrow to Address hold time	35		56		
$T_W(WE)$	WE# asserted width	62		98		
$T_{SU}(CE0)$	CE# \downarrow to WE# \downarrow setup time	0		0		1
$T_{HO}(CE0)$	WE# \uparrow to CE# = 0 hold time	0		0		2
$T_{HO}(CE1)$	OE# or WE# \uparrow to CE# = 1 hold time	8		42		
$T_{SU}(CE1)$	CE# \uparrow to WE# or OE# \downarrow setup time	8		42		
T_{REC}	WE# \uparrow to start of next cycle	22		59		
$T_{SU}(D)$	D to WE# \uparrow setup time	50		48		
$T_{HO}(D)$	WE# \uparrow to D hold time	0		40		

1. CE# may be asserted any time before or after WE# is asserted. If CE# is asserted after WE#, all timing relative to WE# asserted will be referenced instead to the time CE# was asserted.
2. CE# may be negated any time before or after WE# is negated. If CE# is negated before WE#, all timing relative to WE# negated will be referenced instead to the time CE# was negated.

8.4 Mechanical Dimensions

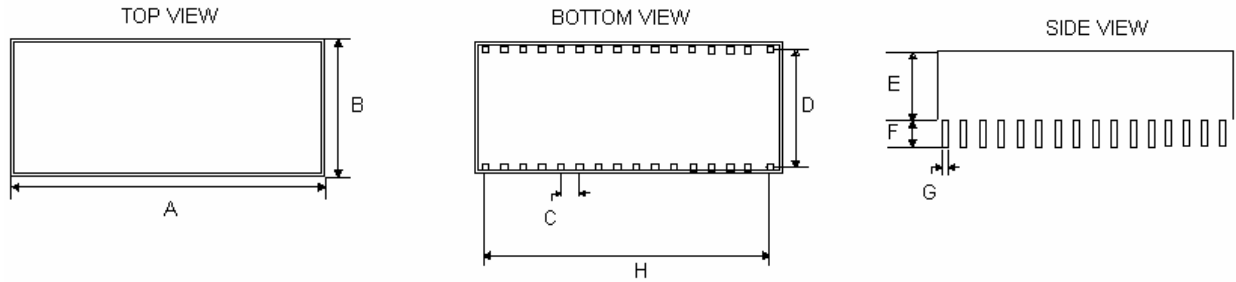

Figure 11: MD220x Mechanical Dimensions

Table 10: Low-Profile

	MD2200	MD2202
	Millimeters (max.)	Millimeters (max.)
A	41.9	43.95
B	18.05	18.3
C	2.54	2.54
D	15.24	15.24
E	5.7	6.0
F	4.0	4.0
G	0.51	0.51
H	38.2	38.2

Table 11: High-Profile

	MD2203
	Millimeters (max.)
A	45.6
B	18.8
C	2.54
D	15.24
E	13.5
F	4.0
G	0.51
H	38.2

Note: The above dimensions are maximum values.

9. ORDERING INFORMATION

MD2200-DCC-V-T (Low-Profile)

CC:	Capacity (MB)	24	
V:	Supply Voltage	Blank	5V
		V3	3.3V
T:	Temperature Range (optional)	Blank	Commercial: 0°C to +70°C
		X	Extended: -40°C to +85°C

MD2202-DCCC-V-T (Low-Profile)

CC:	Capacity (MB)	16, 32, 48, 64, 96, 128, 192, 256, 384	
V:	Supply Voltage	Blank	5V
		V3	3.3V
T:	Temperature Range (optional)	Blank	Commercial: 0°C to +70°C
		X	Extended: -40°C to +85°C

MD2203-DCCC-V-T (High-Profile)

CCC	Capacity (MB)	576, 768, 1024	
:			
V:	Supply Voltage	Blank	5V
		V3	3.3V
T:	Temperature Range (optional)	Blank	Commercial: 0°C to +70°C
		X	Extended: -40°C to +85°C

HOW TO CONTACT US

USA

M-Systems Inc.
8371 Central Ave, Suite A
Newark CA 94560
Phone: +1-510-494-2090
Fax: +1-510-494-5545

Japan

M-Systems Japan Inc.
Asahi Seimei Gotanda Bldg., 3F
5-25-16 Higashi-Gotanda
Shinagawa-ku Tokyo, 141-0022
Phone: +81-3-5423-8101
Fax: +81-3-5423-8102

Taiwan

M-Systems Asia Ltd.
14 F, No. 6, Sec. 3
Minqun East Road
Taipei, Taiwan, 104
Tel: +886-2-2515-2522
Fax: +886-2-2515-2295

China

M-Systems China Ltd.
Room 121-122
Bldg. 2, International Commerce & Exhibition Ctr.
Hong Hua Rd.
Futian Free Trade Zone
Shenzhen, China
Phone: +86-755-8348-5218
Fax: +86-755-8348-5418

Europe

M-Systems Ltd.
7 Atir Yeda St.
Kfar Saba 44425, Israel
Tel: +972-9-764-5000
Fax: +972-3-548-8666

Internet

www.m-systems.com

General Information

info@m-sys.com

Sales and Technical Information

techsupport@m-sys.com

This document is for information use only and is subject to change without prior notice. M-Systems Flash Disk Pioneers Ltd. assumes no responsibility for any errors that may appear in this document. No part of this document may be reproduced, transmitted, transcribed, stored in a retrievable manner or translated into any language or computer language, in any form or by any means, electronic, mechanical, magnetic, optical, chemical, manual or otherwise, without prior written consent of M-Systems.

M-Systems products are not warranted to operate without failure. Accordingly, in any use of the Product in life support systems or other applications where failure could cause injury or loss of life, the Product should only be incorporated in systems designed with appropriate and sufficient redundancy or backup features.

Contact your local M-Systems sales office or distributor, or visit our website at www.m-systems.com to obtain the latest specifications before placing your order.

© 2004 M-Systems Flash Disk Pioneers Ltd. All rights reserved.

M-Systems, DiskOnChip, DiskOnChip Millennium, DiskOnKey, DiskOnKey MyKey, FFD, Fly-By, iDiskOnChip, iDOC, mDiskOnChip, mDOC, Mobile DiskOnChip, Smart DiskOnKey, SmartCaps, SuperMAP, TrueFFS, uDiskOnChip, uDOC, and Xkey are trademarks or registered trademarks of M-Systems Flash Disk Pioneers, Ltd. Other product names or service marks mentioned herein may be trademarks or registered trademarks of their respective owners and are hereby acknowledged. All specifications are subject to change without prior notice.

Looking for pricing, stock, or lifecycle information?

Click below to explore more details on WIN SOURCE:

 [View MD2202-D96 on WIN SOURCE](#)

 [SanDisk Information](#)

Optimize Your Supply Chain with WIN SOURCE Solutions

-  Global Sourcing Solution
-  Obsolete Management
-  Cost Control Management
-  Shortage Management
-  Alternative Solution
-  Excess Inventory Management