

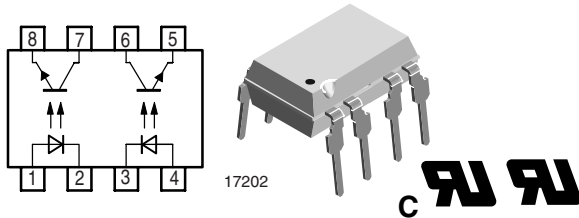

THE DATASHEET OF MCT6H



Optocoupler, Phototransistor Output, Dual Channel



FEATURES

- Current transfer ratio (CTR) of typical 100 %
- Isolation test voltage $V_{ISO} = 5300 V_{RMS}$
- Low temperature coefficient of CTR
- Low coupling capacitance of typical 0.3 pF
- Wide ambient temperature range
- Lead (Pb)-free component
- Component in accordance to RoHS 2002/95/EC and WEEE 2002/96/EC



RoHS
COMPLIANT

DESCRIPTION

The MCT6H and MCT62H consist of a phototransistor optically coupled to a gallium arsenide infrared emitting diode in a 6-lead plastic dual in line package.

The elements are mounted on one leadframe, providing a fixed distance between input and output for highest safety requirements.

APPLICATIONS

- Galvanically separated circuits
- Non-interacting switches

AGENCY APPROVALS

- UL1577, file no. E76222 system code U, double protection

ORDER INFORMATION

PART	REMARKS
MCT6H	CTR > 50 %, DIP-8
MCT62H	CTR > 100 %, DIP-8

Note

MCT6H and MCT62H are marked as MCT6 and MCT62 respectively.

ABSOLUTE MAXIMUM RATINGS ⁽¹⁾

PARAMETER	TEST CONDITION	PART	SYMBOL	VALUE	UNIT
INPUT					
Reverse voltage			V_R	6	V
Forward current			I_F	60	mA
Forward surge current	$t_p \leq 10 \mu s$		I_{FSM}	1.5	A
Power dissipation			P_{diss}	100	mW
Junction temperature			T_j	125	°C
OUTPUT					
Collector emitter voltage			V_{CEO}	70	V
Emitter collector voltage			V_{ECO}	7	V
Collector current			I_C	50	mA
Collector peak current	$t_p/T = 0.5, t_p \leq 10 ms$		I_{CM}	100	mA
Power dissipation			P_{diss}	150	mW
Junction temperature			T_j	125	°C
COUPLER					
AC isolation test voltage (RMS)	$t = 1.0 min$		V_{ISO}	5000	V_{RMS}
Total power dissipation			P_{tot}	250	mW
Ambient temperature range			T_{amb}	- 55 to + 100	°C
Storage temperature range			T_{stg}	- 55 to + 125	°C
Soldering temperature ⁽²⁾	2 mm from case, $t \leq 10 s$		T_{sld}	260	°C

Notes

⁽¹⁾ $T_{amb} = 25 \text{ }^\circ\text{C}$, unless otherwise specified.

Stresses in excess of the absolute maximum ratings can cause permanent damage to the device. Functional operation of the device is not implied at these or any other conditions in excess of those given in the operational sections of this document. Exposure to absolute maximum ratings for extended periods of the time can adversely affect reliability.

⁽²⁾ Refer to wave profile for soldering conditions for through hole devices.



ELECTRICAL CHARACTERISTICS (1)						
PARAMETER	TEST CONDITION	SYMBOL	MIN.	TYP.	MAX.	UNIT
INPUT						
Forward voltage	$I_F = 50 \text{ mA}$	V_F		1.25	1.6	V
OUTPUT						
Collector emitter voltage	$I_C = 1 \text{ mA}$	V_{CEO}	70			V
Emitter collector voltage	$I_E = 100 \mu\text{A}$	V_{ECO}	7			V
Collector dark current	$V_{CE} = 20 \text{ V}, I_F = 0, E = 0$	I_{CEO}			100	nA
COUPLER						
DC isolation test voltage	$t = 2 \text{ s}$	V_{ISO}	5000			V_{RMS}
Isolation resistance	$V_{IO} = 1000 \text{ V},$ 40 % relative humidity	R_{IO}		10^{12}		Ω
Collector emitter saturation voltage	$I_F = 10 \text{ mA}, I_C = 1 \text{ mA}$	V_{CEsat}			0.3	V
Cut off frequency	$I_F = 10 \text{ mA}, V_{CE} = 5 \text{ V},$ $R_L = 100 \Omega$	f_C		100		kHz
Coupling capacitance	$f = 1 \text{ MHz}$	C_k		0.3		pF

Note

(1) $T_{amb} = 25 \text{ }^\circ\text{C}$, unless otherwise specified.

Minimum and maximum values are testing requirements. Typical values are characteristics of the device and are the result of engineering evaluation. Typical values are for information only and are not part of the testing requirements.

CURRENT TRANSFER RATIO							
PARAMETER	TEST CONDITION	PART	SYMBOL	MIN.	TYP.	MAX.	UNIT
I_C/I_F	$V_{CE} = 5 \text{ V}, I_F = 5 \text{ mA}$	MCT6H	CTR	50	100		%
	$V_{CE} = 5 \text{ V}, I_F = 10 \text{ mA}$	MCT6H	CTR	60	120		%
	$V_{CE} = 5 \text{ V}, I_F = 5 \text{ mA}$	MCT62H	CTR	100	200		%

SWITCHING CHARACTERISTICS						
PARAMETER	TEST CONDITION	SYMBOL	MIN.	TYP.	MAX.	UNIT
Delay time	$V_S = 5 \text{ V}, I_C = 2 \text{ mA}, R_L = 100 \Omega$ (see figure 1)	t_d		3		μs
Rise time	$V_S = 5 \text{ V}, I_C = 2 \text{ mA}, R_L = 100 \Omega$ (see figure 1)	t_r		3		μs
Fall time	$V_S = 5 \text{ V}, I_C = 2 \text{ mA}, R_L = 100 \Omega$ (see figure 1)	t_f		4.7		μs
Storage time	$V_S = 5 \text{ V}, I_C = 2 \text{ mA}, R_L = 100 \Omega$ (see figure 1)	t_s		0.3		μs
Turn-on time	$V_S = 5 \text{ V}, I_C = 2 \text{ mA}, R_L = 100 \Omega$ (see figure 1)	t_{on}		6		μs
Turn-off time	$V_S = 5 \text{ V}, I_C = 2 \text{ mA}, R_L = 100 \Omega$ (see figure 1)	t_{off}		5		μs

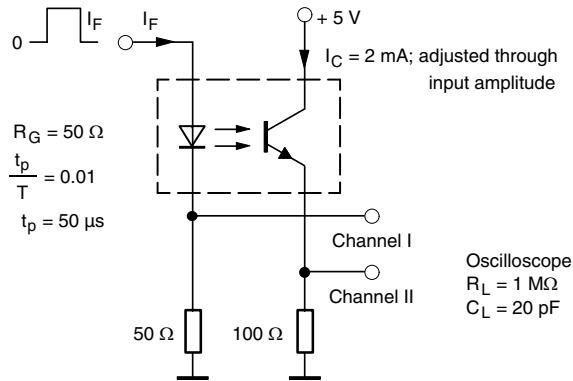

95 10804

Fig. 1 - Test Circuit, non Saturated Operation

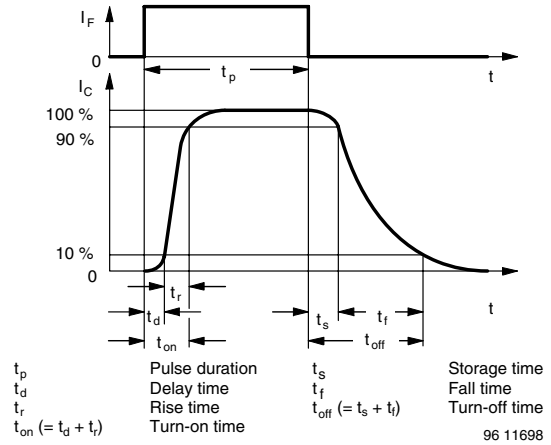

Fig. 2 - Switching Times

TYPICAL CHARACTERISTICS

$T_{amb} = 25 \text{ }^\circ\text{C}$, unless otherwise specified

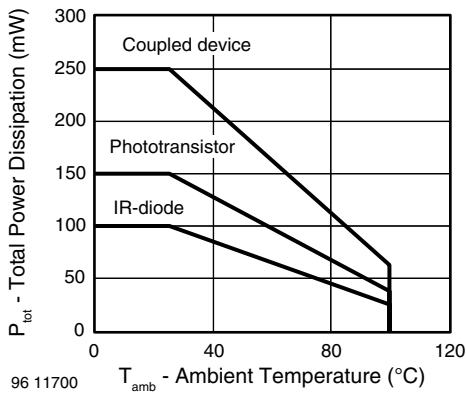

Fig. 3 - Total Power Dissipation vs. Ambient Temperature

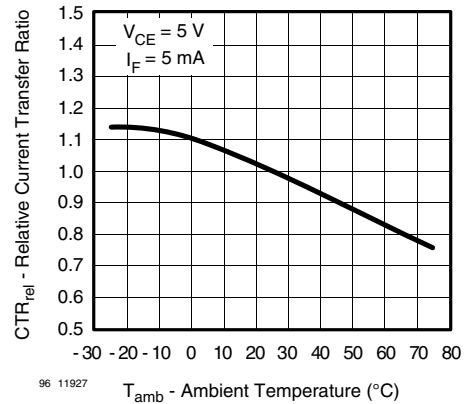

Fig. 5 - Relative Current Transfer Ratio vs. Ambient Temperature

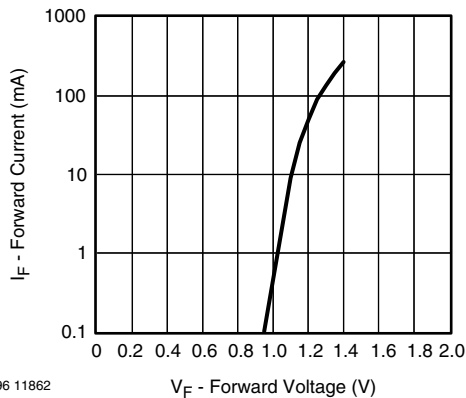

Fig. 4 - Forward Current vs. Forward Voltage

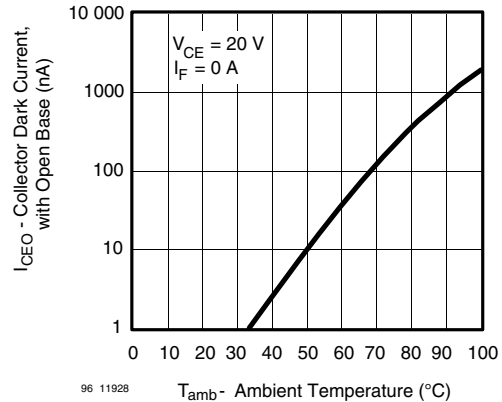

Fig. 6 - Collector Dark Current vs. Ambient Temperature

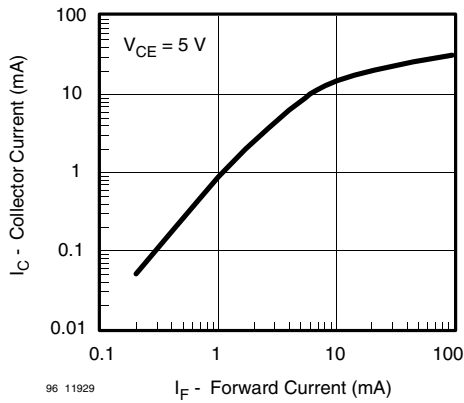

Fig. 7 - Collector Current vs. Forward Current

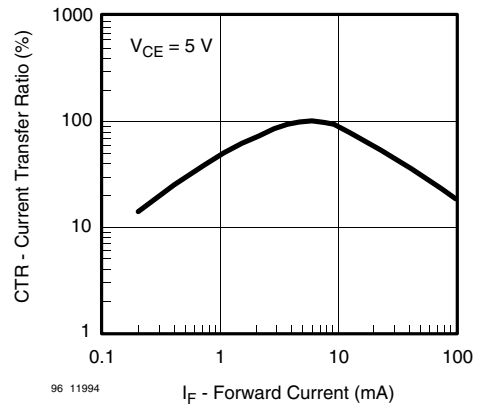

Fig. 10 - Current Transfer Ratio vs. Forward Current

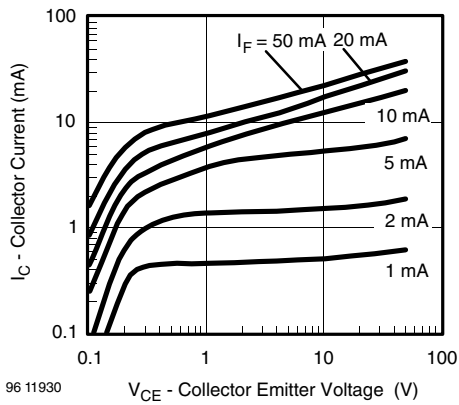

Fig. 8 - Collector Current vs. Collector Emitter Voltage

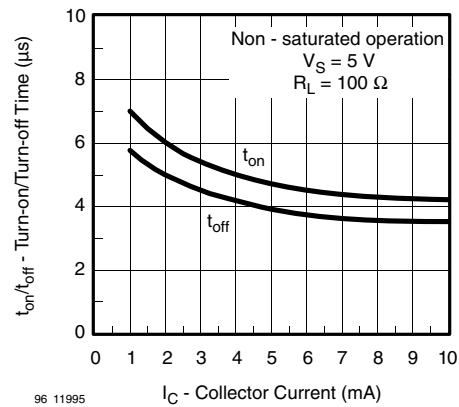

Fig. 11 - Turn-on/Turn-off Time vs. Collector Current

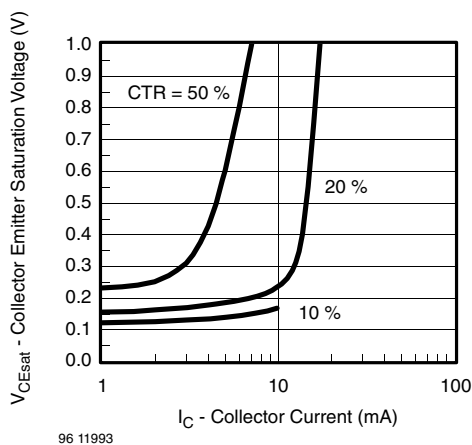

Fig. 9 - Collector Emitter Saturation Voltage vs. Collector Current

MCT6H, MCT62H

Vishay Semiconductors

Optocoupler, Phototransistor
Output, Dual Channel



PACKAGE DIMENSIONS in inches (millimeters)

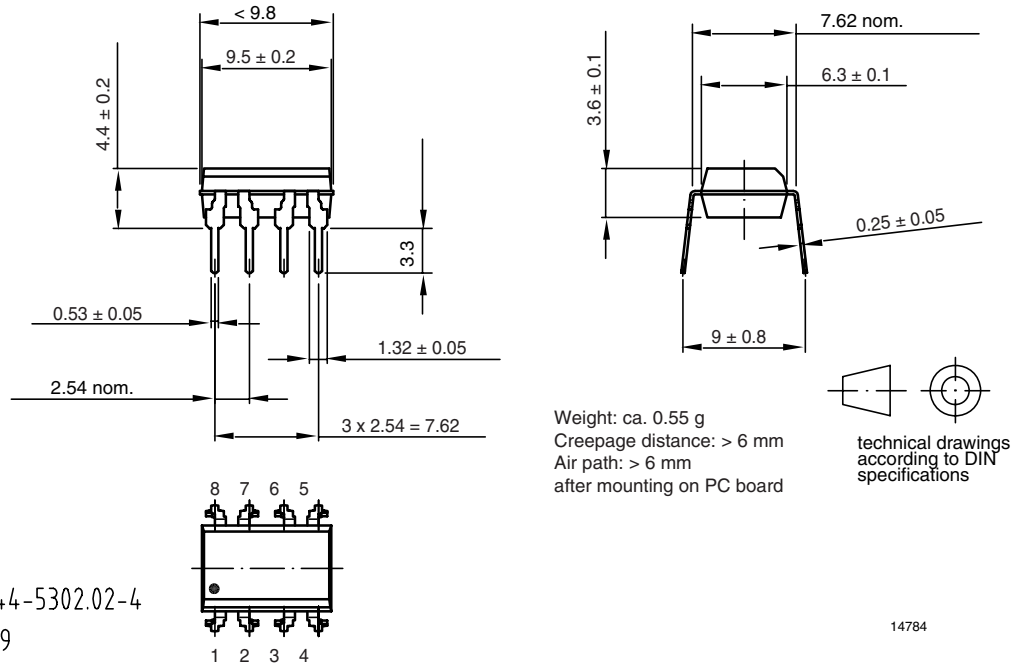

Drawing-No.: 6.544-5302.02-4
Issue: 4; 02.06.99

14784



OZONE DEPLETING SUBSTANCES POLICY STATEMENT

It is the policy of Vishay Semiconductor GmbH to

1. Meet all present and future national and international statutory requirements.
2. Regularly and continuously improve the performance of our products, processes, distribution and operating systems with respect to their impact on the health and safety of our employees and the public, as well as their impact on the environment.

It is particular concern to control or eliminate releases of those substances into the atmosphere which are known as ozone depleting substances (ODSs).

The Montreal Protocol (1987) and its London Amendments (1990) intend to severely restrict the use of ODSs and forbid their use within the next ten years. Various national and international initiatives are pressing for an earlier ban on these substances.

Vishay Semiconductor GmbH has been able to use its policy of continuous improvements to eliminate the use of ODSs listed in the following documents.

1. Annex A, B and list of transitional substances of the Montreal Protocol and the London Amendments respectively.
2. Class I and II ozone depleting substances in the Clean Air Act Amendments of 1990 by the Environmental Protection Agency (EPA) in the USA.
3. Council Decision 88/540/EEC and 91/690/EEC Annex A, B and C (transitional substances) respectively.

Vishay Semiconductor GmbH can certify that our semiconductors are not manufactured with ozone depleting substances and do not contain such substances.

We reserve the right to make changes to improve technical design
and may do so without further notice.

Parameters can vary in different applications. All operating parameters must be validated for each customer application by the customer. Should the buyer use Vishay Semiconductors products for any unintended or unauthorized application, the buyer shall indemnify Vishay Semiconductors against all claims, costs, damages, and expenses, arising out of, directly or indirectly, any claim of personal damage, injury or death associated with such unintended or unauthorized use.

Vishay Semiconductor GmbH, P.O.B. 3535, D-74025 Heilbronn, Germany



Disclaimer

All product specifications and data are subject to change without notice.

Vishay Intertechnology, Inc., its affiliates, agents, and employees, and all persons acting on its or their behalf (collectively, "Vishay"), disclaim any and all liability for any errors, inaccuracies or incompleteness contained herein or in any other disclosure relating to any product.

Vishay disclaims any and all liability arising out of the use or application of any product described herein or of any information provided herein to the maximum extent permitted by law. The product specifications do not expand or otherwise modify Vishay's terms and conditions of purchase, including but not limited to the warranty expressed therein, which apply to these products.

No license, express or implied, by estoppel or otherwise, to any intellectual property rights is granted by this document or by any conduct of Vishay.

The products shown herein are not designed for use in medical, life-saving, or life-sustaining applications unless otherwise expressly indicated. Customers using or selling Vishay products not expressly indicated for use in such applications do so entirely at their own risk and agree to fully indemnify Vishay for any damages arising or resulting from such use or sale. Please contact authorized Vishay personnel to obtain written terms and conditions regarding products designed for such applications.

Product names and markings noted herein may be trademarks of their respective owners.

Looking for pricing, stock, or lifecycle information?

Click below to explore more details on WIN SOURCE:

 [View MCT6H on WIN SOURCE](#)

 [Vishay Information](#)

Optimize Your Supply Chain with WIN SOURCE Solutions

-  Global Sourcing Solution
-  Obsolete Management
-  Cost Control Management
-  Shortage Management
-  Alternative Solution
-  Excess Inventory Management