

●Features

- 1) Full line up from ultra small size (01005) to 2512 with jumper type.
- 2) High reliability metal glazed thick film.
- 3) ROHM resistors have obtained ISO9001/ISO/TS16949 certification.



Part No.	Size		Type code	Packaging specifications	Quantity / Reel	Automotive Grade Available
	(mm)	(inch)				
MCR004	0402	01005	QLP	Paper tape(2mm Pitch)	20,000	—
MCR006	0603	0201	YLP	Paper tape(2mm Pitch)	15,000	Yes
MCR01	1005	0402	MZP	Paper tape(2mm Pitch)	10,000	Yes
MCR03	1608	0603	EZP	Paper tape(4mm Pitch)	5,000	Yes
MCR10	2012	0805	EZP	Paper tape(4mm Pitch)	5,000	Yes
MCR18	3216	1206	EZP	Paper tape(4mm Pitch)	5,000	Yes
MCR25	3225	1210	JZH	Embossed tape(4mm Pitch)	4,000	Yes
MCR50	5025	2010	JZH	Embossed tape(4mm Pitch)	4,000	Yes
MCR100	6432	2512	JZH	Embossed tape(4mm Pitch)	4,000	Yes

●Part number description

Part No.	Size (mm [inch])	Type code	Resistance tolerance	Nominal resistance						
MCR (Micro chip resistors)	004 (0402 [01005]) 006 (0603 [0201]) 01 (1005 [0402]) 03 (1608 [0603]) 10 (2012 [0805]) 18 (3216 [1206]) 25 (3225 [1210]) 50 (5025 [2010]) 100 (6432 [2512])	QLP	D (±0.5%) F (±1%) FX (±1%) *Only MCR03EZP J (±5%) (Including jumper type)	Resistance code, 3 or 4 digits. 000 denotes jumper type. <table border="1"> <thead> <tr> <th>Resistance tolerance</th> <th>Resistance code</th> </tr> </thead> <tbody> <tr> <td>D, F</td> <td>: 4 digits</td> </tr> <tr> <td>J</td> <td>: 3 digits</td> </tr> </tbody> </table>	Resistance tolerance	Resistance code	D, F	: 4 digits	J	: 3 digits
Resistance tolerance	Resistance code									
D, F	: 4 digits									
J	: 3 digits									
				EX.) 1Ω = 1R0 (±5%) 9.1Ω = 9R1 (±5%) 10Ω = 10R0 (±0.5%, ±1%) 100 (±5%) 2.2MΩ = 2204 (±0.5%, ±1%) 225 (±5%)						

● Products list

Part No.	Type code	Rated power (70°C) (W)	Limiting element voltage (V)	Temperature coefficient (ppm/°C)	Resistance tolerance (%)	Resistance range (Ω)	Operating temperature range (°C)
MCR004	QLP	0.031	15	±300	F (±1%)	10 ≤ R < 100 (E24/96 series)	-55 ~ +125
				±250	F (±1%)	100 ≤ R ≤ 3M (E24/96 series)	
				+600/-100	J (±5%)	1.0 ≤ R < 10 (E24 series)	
				±300	J (±5%)	10 ≤ R < 100 (E24 series)	
				±250	J (±5%)	100 ≤ R ≤ 3M (E24 series)	
Jumper type) Rmax : 50mΩMax., Imax : 0.5A							
MCR006	YLP	0.05	25	±200	D (±0.5%)	10 ≤ R < 1k (E24/96 series)	-55 ~ +125
				±100	D (±0.5%)	1k ≤ R ≤ 1M (E24/96 series)	
				±250	F (±1%)	10 ≤ R ≤ 10M (E24/96 series)	
				+600/-200	J (±5%)	1 ≤ R < 10 (E24 series)	
				±250	J (±5%)	10 ≤ R ≤ 10M (E24 series)	
Jumper type) Rmax : 50mΩMax., Imax : 0.5A							
MCR01	MZP	0.063	50	±100	D (±0.5%)	10 ≤ R < 100 (E24 series)	-55 ~ +155
				±50	D (±0.5%)	100 ≤ R ≤ 1M (E24 series)	
				±100	F (±1%)	10 ≤ R ≤ 2.2M (E24/96 series)	
				+500/-250	J (±5%)	1.0 ≤ R < 10 (E24 series)	
				±200	J (±5%)	10 ≤ R ≤ 10M (E24 series)	
Jumper type) Rmax : 50mΩMax., Imax : 1A							
MCR03	EZP	0.10	50	±100	D (±0.5%)	10 ≤ R < 100 (E24/96 series)	-55 ~ +155
				±50	D (±0.5%)	100 ≤ R ≤ 1M (E24/96 series)	
				±100	FX (±1%)	10 ≤ R ≤ 10M (E24/96 series)	
				±400	J (±5%)	1 ≤ R < 10 (E24 series)	
				±200	J (±5%)	10 ≤ R ≤ 10M (E24 series)	
Jumper type) Rmax : 50mΩMax., Imax : 1A							
MCR10	EZP	0.100	150	±100	D (±0.5%)	10 ≤ R < 100 (E24/96 series)	-55 ~ +155
				±50	D (±0.5%)	100 ≤ R ≤ 1M (E24/96 series)	
		0.125	150	±100	F (±1%)	10 ≤ R ≤ 2.2M (E24/96 series)	-55 ~ +155
				±400	J (±5%)	1.0 ≤ R < 10 (E24 series)	
				±200	J (±5%)	10 ≤ R ≤ 10M (E24 series)	
Jumper type) Rmax : 50mΩMax., Imax : 2A							
MCR18	EZP	0.125	200	±100	D (±0.5%)	10 ≤ R < 100 (E24/96 series)	-55 ~ +155
				±50	D (±0.5%)	100 ≤ R ≤ 1M (E24/96 series)	
		0.25	200	±100	F (±1%)	10 ≤ R ≤ 2.2M (E24/96 series)	-55 ~ +155
				±400	J (±5%)	1.0 ≤ R < 10 (E24 series)	
				±200	J (±5%)	10 ≤ R ≤ 10M (E24 series)	
Jumper type) Rmax : 50mΩMax., Imax : 2A							
MCR25	JZH	0.5 to 0.5*1	200	±100	F (±1%)	10 ≤ R ≤ 1M (E24/96 series)	-55 ~ +155
				500±350	J (±5%)	1.0 ≤ R < 2.2 (E24 series)	
				±500	J (±5%)	2.2 ≤ R < 5.6 (E24 series)	
				±200	J (±5%)	5.6 ≤ R ≤ 3.3M (E24 series)	
				Jumper type) Rmax : 50mΩMax., Imax : 2A			
MCR50	JZH	0.5	200	±100	F (±1%)	10 ≤ R ≤ 180k (E24/96 series)	-55 ~ +155
				500±350	J (±5%)	1.0 ≤ R < 2.2 (E24 series)	
				±500	J (±5%)	2.2 ≤ R < 10 (E24 series)	
				±200	J (±5%)	10 ≤ R ≤ 330k (E24 series)	
				±350	J (±5%)	330k < R ≤ 560k (E24 series)	
Jumper type) Rmax : 50mΩMax., Imax : 3A							
MCR100	JZH	1	200	±100	F (±1%)	10 ≤ R ≤ 82k (E24/96 series)	-55 ~ +125
				500±350	J (±5%)	1.0 ≤ R < 2.2 (E24 series)	
				±500	J (±5%)	2.2 ≤ R < 10 (E24 series)	
				±350	J (±5%)	10 ≤ R < 24 (E24 series)	
				±200	J (±5%)	24 ≤ R ≤ 100k (E24 series)	
Jumper type) Rmax : 50mΩMax., Imax : 4A							

* Design and specifications are subject to change without notice. Carefully check the specification sheet supplied with the product before using or ordering it.

* Rated voltage is determined from the following.

When rated voltage exceeds the limiting element voltage, the limiting element voltage shall be the rated voltage.

* Rated voltage = $\sqrt{\text{Rated power} \times \text{Resistance}}$

* E24 : Standard products, E96 : Custom products

*1. Rated power 1Ω~9.76Ω : 0.25W, 10Ω~9.76kΩ : 0.5W, 10kΩ~3.3MΩ : 0.33W

● Chip resistor dimensions and markings

■ MCR 004 / 006 / 01 / 03

■ MCR 10 / 18 / 25 / 50 / 100



<Marking method>

There are three or four digits used for the calculation number according to IEC code and Ris used for the decimal point.

(Unit:mm)

Part No.	Type code	(mm)	(inch)	L	W	t	a	b	Marking existence
MCR004	QLP	0402	01005	0.40±0.02	0.20±0.02	0.13±0.02	0.10±0.03	0.10±0.03	No
MCR006	YLP	0603	0201	0.60±0.03	0.30±0.03	0.23±0.03	0.10±0.05	0.15±0.05	No
MCR01	MZP	1005	0402	1.00±0.05	0.50±0.05	0.35±0.05	0.20±0.10	0.25 ^{+0.05} -0.10	No
MCR03	EZP	1608	0603	1.60±0.10	0.80±0.10	0.45±0.10	0.30±0.20	0.30±0.20	Yes*
MCR10	EZP	2012	0805	2.00±0.10	1.25±0.10	0.55±0.10	0.40±0.20	0.40±0.20	Yes
MCR18	EZP	3216	1206	3.20±0.15	1.60±0.15	0.55±0.10	0.50±0.25	0.50±0.25	Yes
MCR25	JZH	3225	1210	3.20±0.15	2.50±0.15	0.55±0.10	0.50±0.25	0.50±0.25	Yes
MCR50	JZH	5025	2010	5.00±0.15	2.50±0.15	0.55±0.15	0.60±0.25	0.60±0.25	Yes
MCR100	JZH	6432	2512	6.30±0.15	3.20±0.15	0.55±0.15	0.60±0.25	0.60±0.25	Yes

Marking method of jumper type

Jumper type	Marking existence
MCR 004 / 006 / 01 / 25 / 50 / 100	No
MCR 03 / 10 / 18	Yes

*Marking method of MCR25/50/100

Blueglass over coat is used for the jumper type.

There is no marking on the jumper type.

*Marking method of MCR03

For MCR03 series resistors, the printing process restricts the marking to three digits/characters.

Consequently, 1% tolerance resistors with values from the E24 series will be marked the same as 5% resistors with the same value, but 1% tolerance resistors with values from the E96 series will not be marked.

Examples:

MCR03EZPJ243	(5% tolerance, E24 / 24 kΩ)	Marking = 243
MCR03EZPF2402	(1% tolerance, E24 / 24 kΩ)	Marking = 243
MCR03EZPF2432	(1% tolerance, E96 / 24.3 kΩ)	No Marking
MCR18EZPJ243	(5% tolerance, E24 / 24 kΩ)	Marking = 243
MCR18EZPF2402	(1% tolerance, E24 / 24 kΩ)	Marking = 2402
MCR18EZPF2432	(1% tolerance, E96 / 24.3 kΩ)	Marking = 2432

●Land pattern example



(Unit:mm)

Dimensions Part No.	A	B	C	D
MCR004	0.12	0.48	0.22	0.18
MCR006	0.3	0.84	0.3	0.27
MCR01	0.5	1.3	0.5	0.4
MCR03	1.0	2.0	0.8	0.5
MCR10	1.2	2.6	1.15	0.7
MCR18	2.2	4.0	1.5	0.9
MCR25	2.2	4.0	2.3	0.9
MCR50	3.8	6.0	2.3	1.1
MCR100	5.1	8.1	3.0	1.5

●Derating curve

When the ambient temperature exceeds 70°C, power dissipation must be adjusted according to the derating curves below.

■MCR004 / 100



■MCR006 / 01 / 03 / 10 / 18 / 25 / 50



●Characteristics

Test items	Guaranteed value		Test conditions
	Resistor type	Jumper type	
Resistance	See "Products list"		20°C
Variation of resistance with temperature	See "Products list"		Measurement: +25/-55, +25/+125°C
Overload	±(2.0% + 0.1Ω)	MAX. 50mΩ	Test voltage is the smaller one of ① or ② ① Rated voltage(current)×2.5, 2s ② Maximum overload voltage ※
Solderability	A new uniform coating of minimum of 95% of the surface being immersed and no soldering damage.		Rosin-ethanol solution(25% w weight) Soldering condition: 245±5°C Duration of immersion: 2.0±0.5s
Resistance to soldering heat	±(1.0% + 0.05Ω) No remarkable abnormality on the appearance.	MAX. 50mΩ	Soldering condition: 260±5°C Duration of immersion: 10±1s
Rapid change of temperature	±(1.0% + 0.05Ω)	MAX. 50mΩ	Test temp. -55°C ~ +125°C 1000cycle(MCR01) -55°C ~ +125°C 100cycle(MCR004/006) -55°C ~ +125°C 5cycle(MCR03/10/18/25/50/100)
Damp heat, steady state	±(3.0% + 0.1Ω)	MAX. 100mΩ	40°C, 93%(Relative humidity) Test time: 1,000h
Endurance at 70°C	±(3.0% + 0.1Ω)	MAX. 100mΩ	Rated voltage(current), 70°C±3°C 1.5h:ON—0.5h:OFF Test time: 1,000h
Endurance	±(3.0% + 0.1Ω)	MAX. 100mΩ	125°C(MCR004/100) 155°C(MCR006/01/03/10/18/25/50) Test time: 1,000h
Resistance to solvent	±(1.0% + 0.05Ω)	MAX. 50mΩ	23±5°C, Immersion cleaning, 5±0.5min Solvent: 2-propanol
Bend strength of the end face plating	±(1.0% + 0.05Ω) Without mechanical damage such as breaks.	MAX. 50mΩ	-

※Maximum overload voltage (Test voltage)

Compliance Standard(s) : IEC60115-8

MCR004	MCR006	MCR01	MCR03	MCR10	MCR18	MCR25	MCR50	MCR100
30V	50V	100V	100V	200V	400V	400V	400V	400V

JISC 5201-8

●Tape dimensions

(Unit : mm)

■Paper tape



Part No.	Type code	W	F	E	A0	B0
MCR004	QLP	8.0±0.20	3.5±0.05	1.75±0.10	0.24±0.03	0.45±0.03
MCR006	YLP	8.0±0.20	3.5±0.05	1.75±0.10	0.38±0.03	0.68±0.03
MCR01	MZP	8.0±0.3	3.5±0.05	1.75±0.1	0.7±0.1	1.2±0.1
MCR03	EZP	8.0±0.3	3.5±0.05	1.75±0.1	1.1±0.1	1.9±0.1
MCR10	EZP	8.0±0.3	3.5±0.05	1.75±0.1	1.65 ^{+0.2} _{-0.1}	2.4 ^{+0.2} _{-0.1}
MCR18	EZP	8.0±0.3	3.5±0.05	1.75±0.1	1.95 ^{+0.1} _{-0.05}	3.5 ^{+0.15} _{-0.05}

Part No.	Type code	D0	P0	P1	P2	T2
MCR004	QLP	Φ1.5 ^{+0.10} ₀	4.0±0.10	2.0±0.05	2.0±0.05	MAX0.50
MCR006	YLP	Φ1.5 ^{+0.10} ₀	4.0±0.10	2.0±0.05	2.0±0.05	MAX0.50
MCR01	MZP	Φ1.5 ^{+0.1} ₀	4.0±0.1	2.0±0.05	2.0±0.05	MAX1.1
MCR03	EZP	Φ1.5 ^{+0.1} ₀	4.0±0.1	4.0±0.1	2.0±0.05	MAX1.1
MCR10	EZP	Φ1.5 ^{+0.1} ₀	4.0±0.1	4.0±0.1	2.0±0.05	MAX1.1
MCR18	EZP	Φ1.5 ^{+0.1} ₀	4.0±0.1	4.0±0.1	2.0±0.05	MAX1.1

■Embossed tape



(Unit : mm)

Part No.	Type code	W	F	E	A0	B0
MCR25	JZH	8.0±0.3	3.5±0.05	1.75±0.1	3.0±0.1	3.5±0.1
MCR50	JZH	12.0±0.3	5.5±0.05	1.75±0.1	3.4±0.2	5.6±0.2
MCR100	JZH	12.0±0.3	5.5±0.05	1.75±0.1	3.5±0.2	6.7±0.2

Part No.	Type code	W	F	E	A0	B0
MCR25	JZH	Φ1.5 ^{+0.1} ₀	4.0±0.1	4.0±0.1	2.0±0.05	MAX1.1
MCR50	JZH	Φ1.5 ^{+0.1} ₀	4.0±0.1	4.0±0.1	2.0±0.05	MAX1.1
MCR100	JZH	Φ1.5 ^{+0.1} ₀	4.0±0.1	4.0±0.1	2.0±0.05	MAX1.1

●Reel dimensions

①MCR 004/006/01/03/10/18/25/50/100

②MCR 004/006/01/03/10/18/25

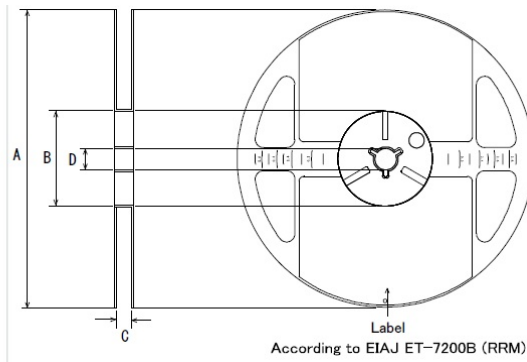

(Unit : mm)

Part No.	Type code	A	B	C	D
MCR004	QLP	$\Phi 180 \begin{matrix} 0 \\ -1.5 \end{matrix}$	$\Phi 60 \begin{matrix} +1.0 \\ 0 \end{matrix}$	$9 \begin{matrix} +1.0 \\ 0 \end{matrix}$	$\Phi 13 \pm 0.2$
MCR006	YLP				
MCR01	MZP				
MCR03	EZP				
MCR10	EZP				
MCR18	EZP				
MCR25	JZH				
MCR50	JZH			$13 \begin{matrix} +1.0 \\ 0 \end{matrix}$	
MCR100	JZH				

Notice

Precaution on using ROHM Products

1. If you intend to use our Products in devices requiring extremely high reliability (such as medical equipment ^(Note 1), aircraft/spacecraft, nuclear power controllers, etc.) and whose malfunction or failure may cause loss of human life, bodily injury or serious damage to property ("Specific Applications"), please consult with the ROHM sales representative in advance. Unless otherwise agreed in writing by ROHM in advance, ROHM shall not be in any way responsible or liable for any damages, expenses or losses incurred by you or third parties arising from the use of any ROHM's Products for Specific Applications.

(Note1) Medical Equipment Classification of the Specific Applications

JAPAN	USA	EU	CHINA
CLASS III	CLASS III	CLASS II b	CLASS III
CLASS IV		CLASS III	

2. ROHM designs and manufactures its Products subject to strict quality control system. However, semiconductor products can fail or malfunction at a certain rate. Please be sure to implement, at your own responsibilities, adequate safety measures including but not limited to fail-safe design against the physical injury, damage to any property, which a failure or malfunction of our Products may cause. The following are examples of safety measures:
 - [a] Installation of protection circuits or other protective devices to improve system safety
 - [b] Installation of redundant circuits to reduce the impact of single or multiple circuit failure
3. Our Products are not designed under any special or extraordinary environments or conditions, as exemplified below. Accordingly, ROHM shall not be in any way responsible or liable for any damages, expenses or losses arising from the use of any ROHM's Products under any special or extraordinary environments or conditions. If you intend to use our Products under any special or extraordinary environments or conditions (as exemplified below), your independent verification and confirmation of product performance, reliability, etc. prior to use, must be necessary:
 - [a] Use of our Products in any types of liquid, including water, oils, chemicals, and organic solvents
 - [b] Use of our Products outdoors or in places where the Products are exposed to direct sunlight or dust
 - [c] Use of our Products in places where the Products are exposed to sea wind or corrosive gases, including Cl₂, H₂S, NH₃, SO₂, and NO₂
 - [d] Use of our Products in places where the Products are exposed to static electricity or electromagnetic waves
 - [e] Use of our Products in proximity to heat-producing components, plastic cords, or other flammable items
 - [f] Sealing or coating our Products with resin or other coating materials
 - [g] Use of our Products without cleaning residue of flux (even if you use no-clean type fluxes, cleaning residue of flux is recommended); or Washing our Products by using water or water-soluble cleaning agents for cleaning residue after soldering
 - [h] Use of the Products in places subject to dew condensation
4. The Products are not subject to radiation-proof design.
5. Please verify and confirm characteristics of the final or mounted products in using the Products.
6. In particular, if a transient load (a large amount of load applied in a short period of time, such as pulse. is applied, confirmation of performance characteristics after on-board mounting is strongly recommended. Avoid applying power exceeding normal rated power; exceeding the power rating under steady-state loading condition may negatively affect product performance and reliability.
7. De-rate Power Dissipation depending on ambient temperature. When used in sealed area, confirm that it is the use in the range that does not exceed the maximum junction temperature.
8. Confirm that operation temperature is within the specified range described in the product specification.
9. ROHM shall not be in any way responsible or liable for failure induced under deviant condition from what is defined in this document.

Precaution for Mounting / Circuit board design

1. When a highly active halogenous (chlorine, bromine, etc.) flux is used, the residue of flux may negatively affect product performance and reliability.
2. In principle, the reflow soldering method must be used on a surface-mount products, the flow soldering method must be used on a through hole mount products. If the flow soldering method is preferred on a surface-mount products, please consult with the ROHM representative in advance.

For details, please refer to ROHM Mounting specification

Precautions Regarding Application Examples and External Circuits

1. If change is made to the constant of an external circuit, please allow a sufficient margin considering variations of the characteristics of the Products and external components, including transient characteristics, as well as static characteristics.
2. You agree that application notes, reference designs, and associated data and information contained in this document are presented only as guidance for Products use. Therefore, in case you use such information, you are solely responsible for it and you must exercise your own independent verification and judgment in the use of such information contained in this document. ROHM shall not be in any way responsible or liable for any damages, expenses or losses incurred by you or third parties arising from the use of such information.

Precaution for Electrostatic

This Product is electrostatic sensitive product, which may be damaged due to electrostatic discharge. Please take proper caution in your manufacturing process and storage so that voltage exceeding the Products maximum rating will not be applied to Products. Please take special care under dry condition (e.g. Grounding of human body / equipment / solder iron, isolation from charged objects, setting of Ionizer, friction prevention and temperature / humidity control).

Precaution for Storage / Transportation

1. Product performance and soldered connections may deteriorate if the Products are stored in the places where:
 - [a] the Products are exposed to sea winds or corrosive gases, including Cl₂, H₂S, NH₃, SO₂, and NO₂
 - [b] the temperature or humidity exceeds those recommended by ROHM
 - [c] the Products are exposed to direct sunshine or condensation
 - [d] the Products are exposed to high Electrostatic
2. Even under ROHM recommended storage condition, solderability of products out of recommended storage time period may be degraded. It is strongly recommended to confirm solderability before using Products of which storage time is exceeding the recommended storage time period.
3. Store / transport cartons in the correct direction, which is indicated on a carton with a symbol. Otherwise bent leads may occur due to excessive stress applied when dropping of a carton.
4. Use Products within the specified time after opening a humidity barrier bag. Baking is required before using Products of which storage time is exceeding the recommended storage time period.

Precaution for Product Label

A two-dimensional barcode printed on ROHM Products label is for ROHM's internal use only.

Precaution for Disposition

When disposing Products please dispose them properly using an authorized industry waste company.

Precaution for Foreign Exchange and Foreign Trade act

Since concerned goods might be fallen under listed items of export control prescribed by Foreign exchange and Foreign trade act, please consult with ROHM in case of export.

Precaution Regarding Intellectual Property Rights

1. All information and data including but not limited to application example contained in this document is for reference only. ROHM does not warrant that foregoing information or data will not infringe any intellectual property rights or any other rights of any third party regarding such information or data.
2. ROHM shall not have any obligations where the claims, actions or demands arising from the combination of the Products with other articles such as components, circuits, systems or external equipment (including software).
3. No license, expressly or implied, is granted hereby under any intellectual property rights or other rights of ROHM or any third parties with respect to the Products or the information contained in this document. Provided, however, that ROHM will not assert its intellectual property rights or other rights against you or your customers to the extent necessary to manufacture or sell products containing the Products, subject to the terms and conditions herein.

Other Precaution

1. This document may not be reprinted or reproduced, in whole or in part, without prior written consent of ROHM.
2. The Products may not be disassembled, converted, modified, reproduced or otherwise changed without prior written consent of ROHM.
3. In no event shall you use in any way whatsoever the Products and the related technical information contained in the Products or this document for any military purposes, including but not limited to, the development of mass-destruction weapons.
4. The proper names of companies or products described in this document are trademarks or registered trademarks of ROHM, its affiliated companies or third parties.

General Precaution

1. Before you use our Products, you are requested to carefully read this document and fully understand its contents. ROHM shall not be in any way responsible or liable for failure, malfunction or accident arising from the use of any ROHM's Products against warning, caution or note contained in this document.
2. All information contained in this document is current as of the issuing date and subject to change without any prior notice. Before purchasing or using ROHM's Products, please confirm the latest information with a ROHM sales representative.
3. The information contained in this document is provided on an "as is" basis and ROHM does not warrant that all information contained in this document is accurate and/or error-free. ROHM shall not be in any way responsible or liable for any damages, expenses or losses incurred by you or third parties resulting from inaccuracy or errors of or concerning such information.



MCR03EZPFX - Web Page

[Distribution Inventory](#)

Part Number	MCR03EZPFX
Package	
Unit Quantity	5000
Minimum Package Quantity	5000
Packing Type	Taping
Constitution Materials List	inquiry
RoHS	Yes

Looking for pricing, stock, or lifecycle information?

Click below to explore more details on WIN SOURCE:

- ⊖ [View MCR25JZHJ331](#) on WIN SOURCE
- ⊖ [Rohm Semiconductor](#) Information

Optimize Your Supply Chain with WIN SOURCE Solutions

- ✓ Global Sourcing Solution
- ✓ Obsolete Management
- ✓ Cost Control Management
- ✓ Shortage Management
- ✓ Alternative Solution
- ✓ Excess Inventory Management