



**THE DATASHEET OF  
MCP14E5-E/SN**



## DESCRIPTION

The MP62170/MP62171 Power Distribution Switch features internal current limiting to prevent damage to host devices due to faulty load conditions. The MP62170/MP62171 analog switch has 75mΩ on-resistance and operates from 2.7V to 5.5V input. It is available with guaranteed current limits, making it ideal for load switching applications. The MP62170/MP62171 has built-in protection for both over current and increased thermal stress. For over current, the device will limit the current by changing to a constant current mode.

As the temperature increases as a result of short circuit, then the device will shut off. The device will recover once the device temperature reduces to approx 120°C.

MP62170/MP62171 is available in 8-pin MSOP and SOIC package without exposed pad.

## FEATURES

- 1.5A Continuous Current
- Accurate Current Limit
- 2.7V to 5.5V Supply Range
- 90uA Quiescent Current
- 75mΩ MOSFET
- Thermal-Shutdown Protection
- Under-Voltage Lockout
- 8ms FLAG Deglitch Time
- No FLAG Glitch During Power Up
- Reverse Current Blocking
- Active High & Active Low Options
- SOIC8 & MSOP8 Packages

## APPLICATIONS

- Smartphone and PDA
- Portable GPS Device
- Notebook PC
- Set-top-box
- Telecom and Network Systems
- PC Card Hot Swap
- USB Power Distribution

"MPS" and "The Future of Analog IC Technology" are Trademarks of Monolithic Power Systems, Inc.

## TYPICAL APPLICATION

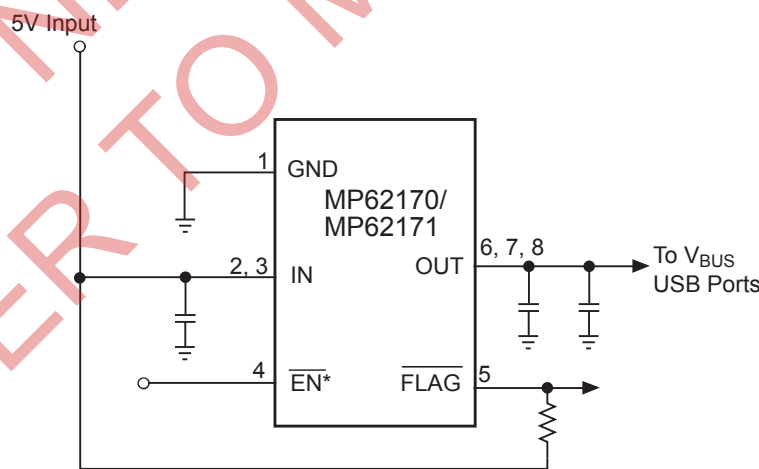

\* EN is active high for MP62171  
SINGLE-CHANNEL

### ORDERING INFORMATION

Part Number	Enable	Switch	Maximum Continuous Load Current	Typical Short-Circuit Current @ T <sub>A</sub> =25°C	Package	Top Marking	Free Air Temperature (T <sub>A</sub> )
MP62170ES	Active Low	Single	1.5A	2.3A	SOIC8	62170ES	-20°C to +85°C
MP62170EK					MSOP8	62170EK	
MP62171ES	Active High				SOIC8	62171ES	
MP62171EK					MSOP8	62171EK	

\* For Tape & Reel, add suffix -Z (g. MP62170ES-Z).

For RoHS compliant packaging, add suffix -LF (e.g. MP62171ES-LF-Z)

### PACKAGE REFERENCE

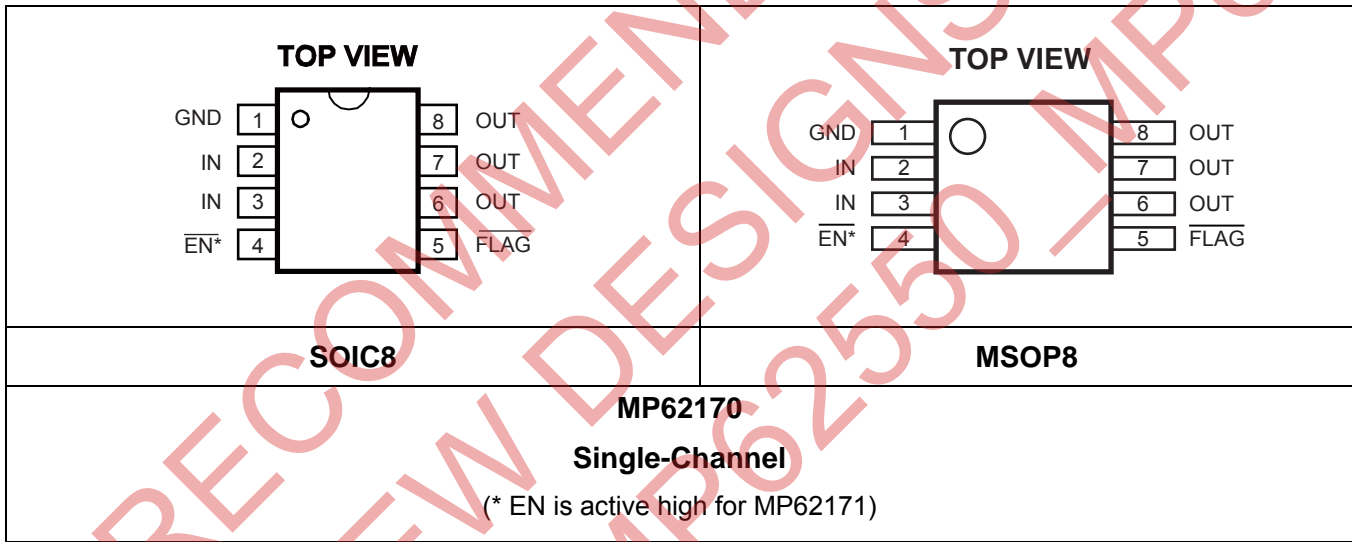

### ABSOLUTE MAXIMUM RATINGS <sup>(1)</sup>

IN .....	-0.3V to +6.0V
EN, FLAG, OUT to GND .....	-0.3V to +6.0V
Continuous Power Dissipation (T <sub>A</sub> = +25°C) <sup>(2)</sup>	
SOIC8.....	1.4W
MSOP8.....	0.8W
Junction Temperature .....	150°C
Lead Temperature .....	260°C
Storage Temperature.....	-65°C to +150°C
Operating Junct. Temp (T <sub>J</sub> ).....	-20°C to +125°C

### Thermal Resistance <sup>(3)</sup>

	$\theta_{JA}$	$\theta_{JC}$
SOIC8.....	90	42
MSOP8.....	150	65

**Notes:**

- Exceeding these ratings may damage the device.
- The maximum allowable power dissipation is a function of the maximum junction temperature T<sub>J</sub> (MAX), the junction-to-ambient thermal resistance  $\theta_{JA}$ , and the ambient temperature T<sub>A</sub>. The maximum allowable continuous power dissipation at any ambient temperature is calculated by P<sub>D</sub> (MAX) = (T<sub>J</sub> (MAX)-T<sub>A</sub>)/ $\theta_{JA}$ . Exceeding the maximum allowable power dissipation will cause excessive die temperature, and the regulator will go into thermal shutdown. Internal thermal shutdown circuitry protects the device from permanent damage.
- Measured on JESD51-7, 4-layer PCB.

**ELECTRICAL CHARACTERISTICS (4)**
 **$V_{IN}=5V$ ,  $T_A=+25^{\circ}C$ , unless otherwise noted.**

Parameter	Condition	Min	Typ	Max	Units
IN Voltage Range		2.7		5.5	V
Supply Current	EN Enabled, $I_{OUT}=0$		90	120	$\mu A$
Shutdown Current	Device Disable, $V_{OUT}=\text{float}$ , $V_{IN}=5.5V$		1		$\mu A$
Off Switch Leakage	Device Disable, $V_{IN}=5.5V$		1		$\mu A$
Current Limit		1.6	2.3	3	A
Trip Current	Current Ramp (slew rate $\leq 100A/s$ ) on Output		2.5	3.3	A
Under-voltage Lockout	Rising Edge	1.95		2.65	V
Under-voltage Hysteresis			250		mV
FET On Resistance	$I_{OUT}=100mA$ ( $-20^{\circ}C \leq T_A \leq +85^{\circ}C$ )		75	130	m $\Omega$
EN Input Logic High Voltage		2			V
EN Input Logic Low Voltage				0.8	V
FLAG Output Logic Low Voltage	$I_{SINK}=5mA$			0.4	V
FLAG Output High Leakage Current	$V_{IN}=V_{FLAG}=5.5V$			1	$\mu A$
Thermal Shutdown			140		$^{\circ}C$
Thermal Shutdown Hysteresis			20		$^{\circ}C$
$V_{OUT}$ Rising Time, $T_r$ (5)	$V_{IN}=5.5V$ , $C_L=1\mu F$ , $R_L=5.5\Omega$		0.9		ms
	$V_{IN}=2.7V$ , $C_L=1\mu F$ , $R_L=5.5\Omega$		1.7		ms
$V_{OUT}$ Falling Time, $T_f$ (6)	$V_{IN}=5.5V$ , $C_L=1\mu F$ , $R_L=5.5\Omega$			0.5	ms
	$V_{IN}=2.7V$ , $C_L=1\mu F$ , $R_L=5.5\Omega$			0.5	ms
Turn On Time, $T_{on}$ (7)	$C_L=100\mu F$ , $R_L=5.5\Omega$			3	ms
Turn Off Time, $T_{off}$ (8)	$C_L=100\mu F$ , $R_L=5.5\Omega$			10	ms
FLAG Deglitch Time		4	8	15	ms
EN Input Leakage			1		$\mu A$
Reverse Leakage Current	$V_{OUT}=5.5V$ , $V_{IN}=GND$		0.2		$\mu A$

**Notes:**

- 4) Production test at  $+25^{\circ}C$ . Specifications over the temperature range are guaranteed by design and characterization.
- 5) Measured from 10% to 90% output signal.
- 6) Measured from 90% to 10% output signal.
- 7) Measured from 50% EN signal to 90% output signal.
- 8) Measured from 50% EN signal to 10% output signal.

## PIN FUNCTIONS

SOIC8 MSOP8	Name	Description
1	GND	Ground.
2, 3	IN	Input Voltage. Accepts 2.7V to 5.5V input.
4	$\overline{\text{EN}}$	Active High: (MP62171), Active Low: (MP62170).
5	$\overline{\text{FLAG}}$	IN-to-OUT Over-current, active-low output flag. Open-Drain.
6, 7, 8	OUT	IN-to-OUT Power-Distribution Output (for all 3 output pins)

## TYPICAL PERFORMANCE CHARACTERISTICS

$T_A = +25^\circ\text{C}$ , unless otherwise noted.

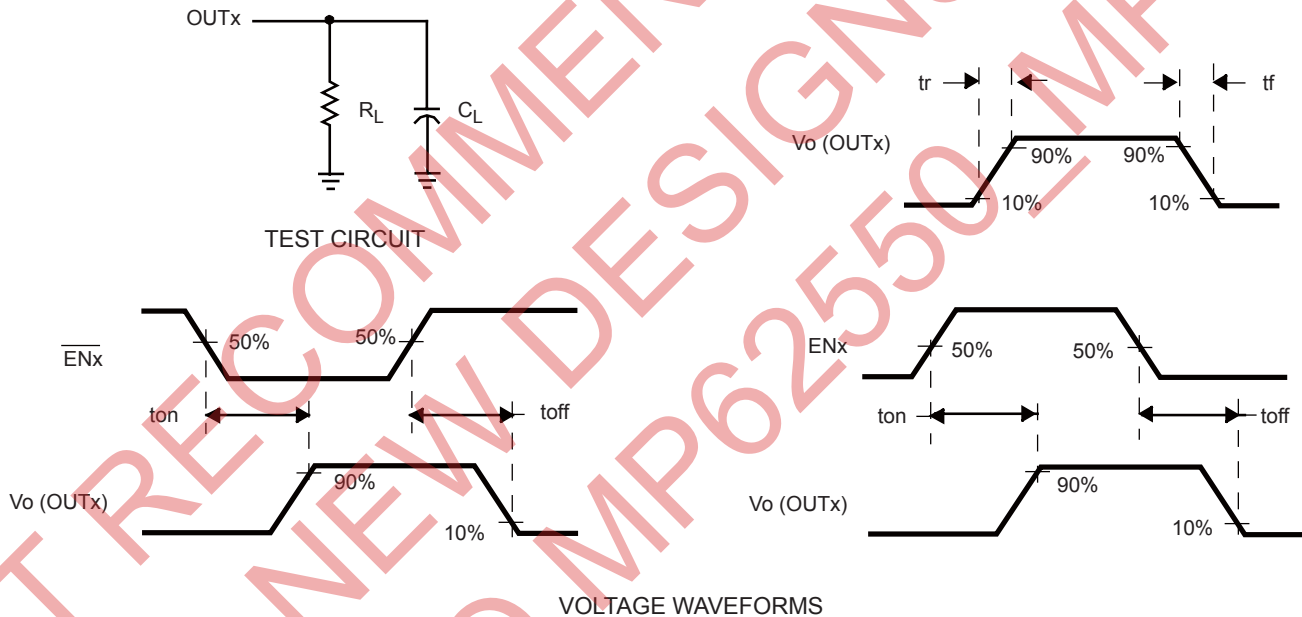
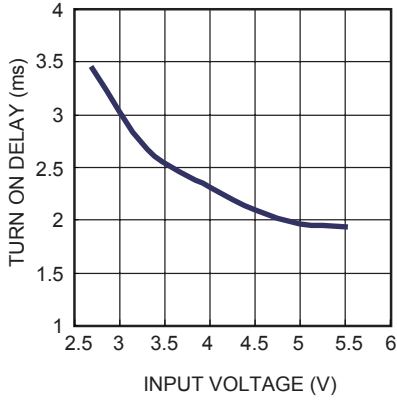

Figure 1—Test Circuit and Voltage Waveforms

**TYPICAL PERFORMANCE CHARACTERISTICS**

$V_{IN}=5V$ ,  $V_{EN}=0V$ ,  $V_{CC}=5V$ ,  $C_L=2.2\mu F$ ,  $T_A=25^\circ C$ , unless otherwise noted.

**Turn on Delay vs. Input Voltage**  
 $R_L=3.6\Omega$ ,  $C_L=100\mu F$



**Turn off Delay vs. Input Voltage**  
 $R_L=3.6\Omega$ ,  $C_L=100\mu F$

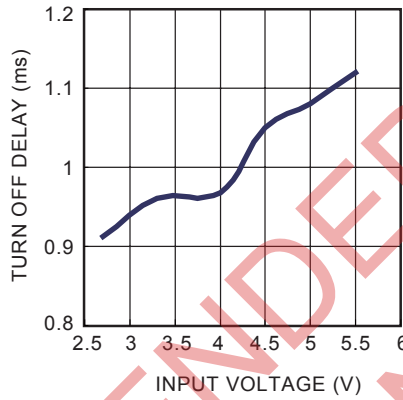

**Rise Time vs. Input Voltage**  
 $R_L=3.6\Omega$

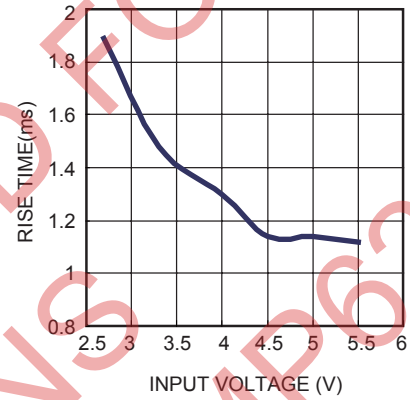

**Fall Time vs. Input Voltage**  
 $R_L=3.6\Omega$

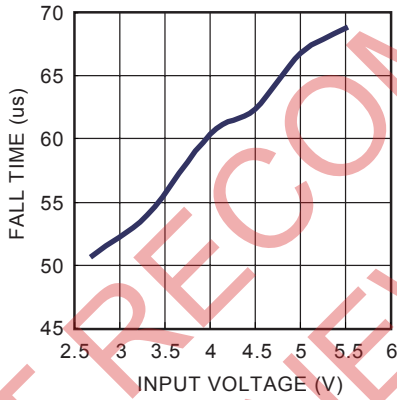

**Supply Current, Output Enabled vs. Input Voltage**

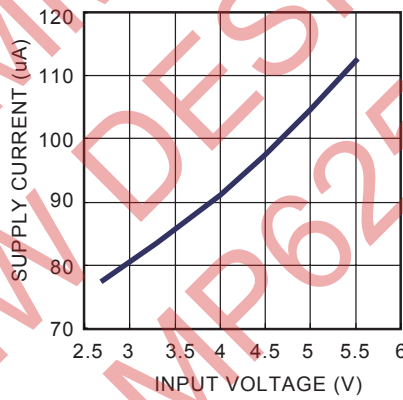

**Static Drain-Source On-State Resistance Variation vs. Ambient Temperature**  
 $I_O=0.1A$

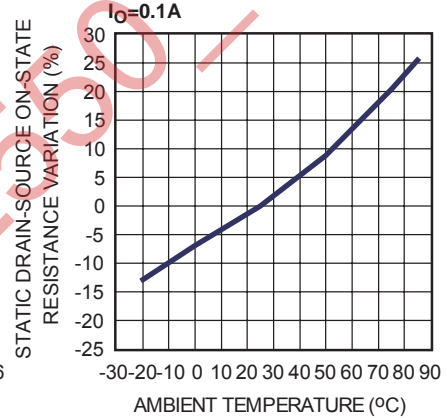

**Static Drain-Source On-State Resistance vs. Input Voltage**  
 $I_O=1.5A$

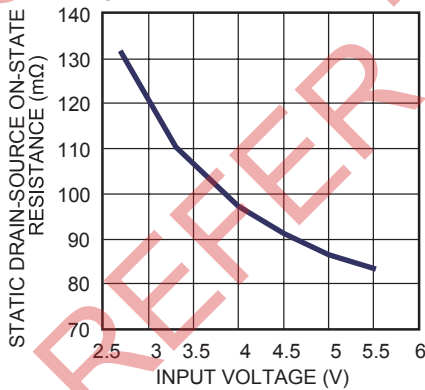

**Input to Output Voltage vs. Load Current**

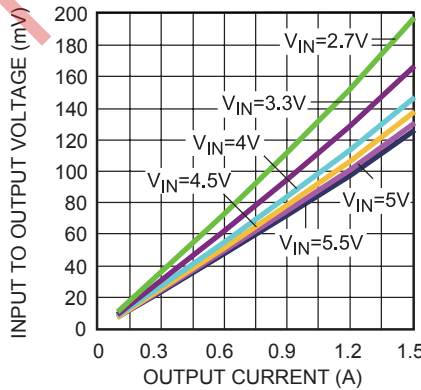

**Current Limit vs. Input Voltage**

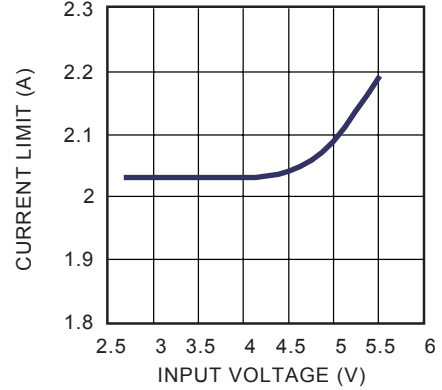

**TYPICAL PERFORMANCE CHARACTERISTICS (CONTINUED)**

$V_{IN}=5V$ ,  $V_{EN}=0V$ ,  $V_{CC}=5V$ ,  $C_L=2.2\mu F$ ,  $T_A=25^\circ C$ , unless otherwise noted.

**Threshold Trip Current vs. Input Voltage**

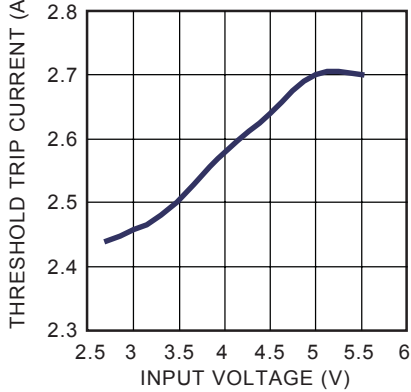

**Current Limit Response vs. Peak Current**

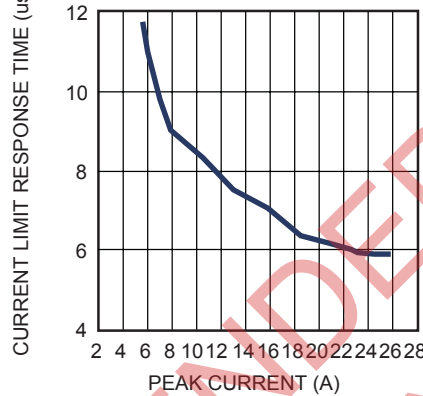

**Turn On Delay and Rise Time with 2.2uF Load**  
 $R_L=3.3\Omega$

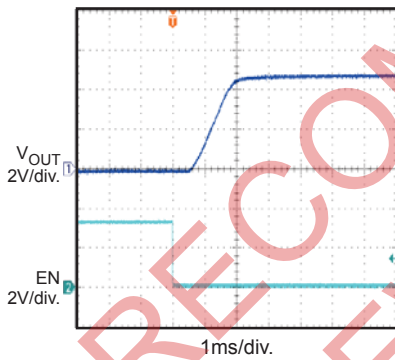

**Turn Off Delay and Fall Time with 2.2uF Load**  
 $R_L=3.3\Omega$

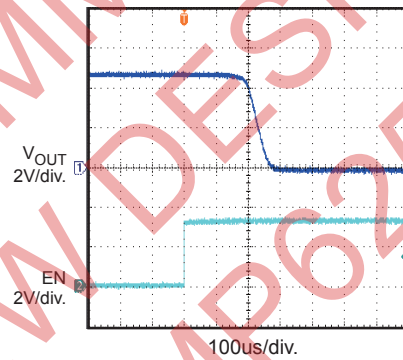

**Turn On Delay and Rise Time with 100uF Load**  
 $C_L=100\mu F$ ,  $R_L=3.3\Omega$

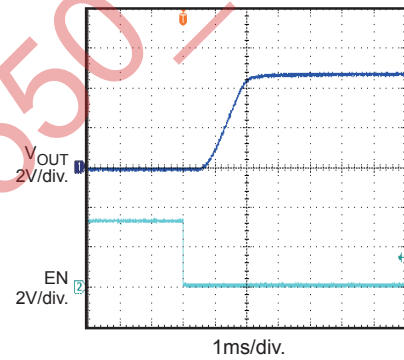

**Turn Off Delay and Fall Time with 100uF Load**  
 $C_L=100\mu F$ ,  $R_L=3.3\Omega$

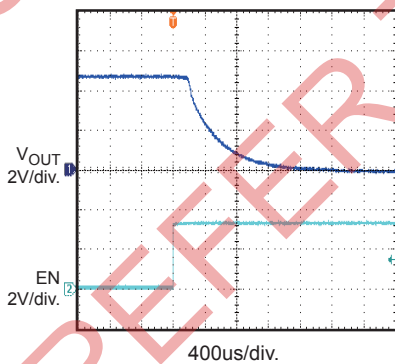

**Short Circuit Current, Device Enabled into Short**

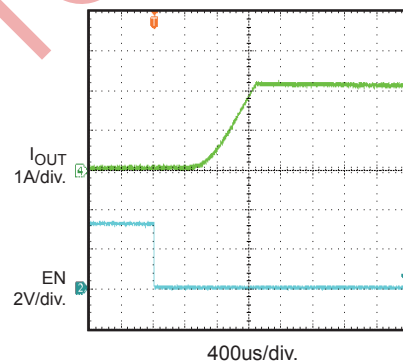

**Threshold Trip Current with Ramped Load on Enabled Device**

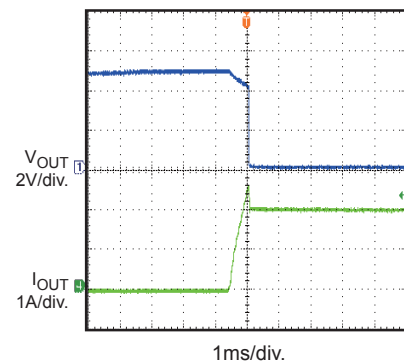

**TYPICAL PERFORMANCE CHARACTERISTICS (CONTINUED)**

$V_{IN}=5V$ ,  $V_{EN}=0V$ ,  $V_{CC}=5V$ ,  $C_L=2.2\mu F$ ,  $T_A=25^\circ C$ , unless otherwise noted.

**Ramped Load on Enabled Device**

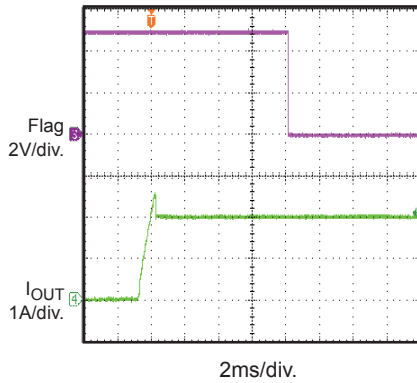

**Inrush Current with Different Load Capacitance**  
 $I_{OUT}=1.5A$

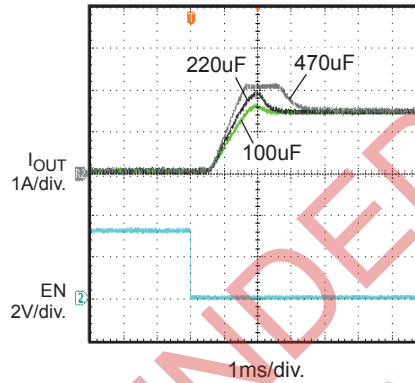

**1Ω Load Connected to Enabled Device**

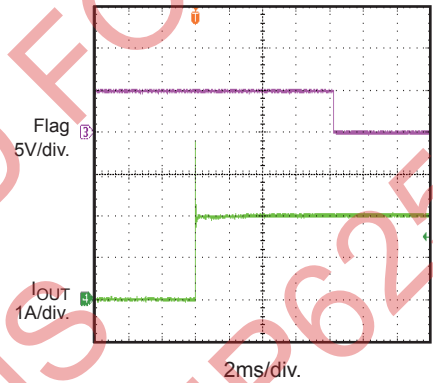

NOT RECOMMENDED FOR NEW DESIGNS REFER TO MP62550 - MP62551

FUNCTION BLOCK DIAGRAM

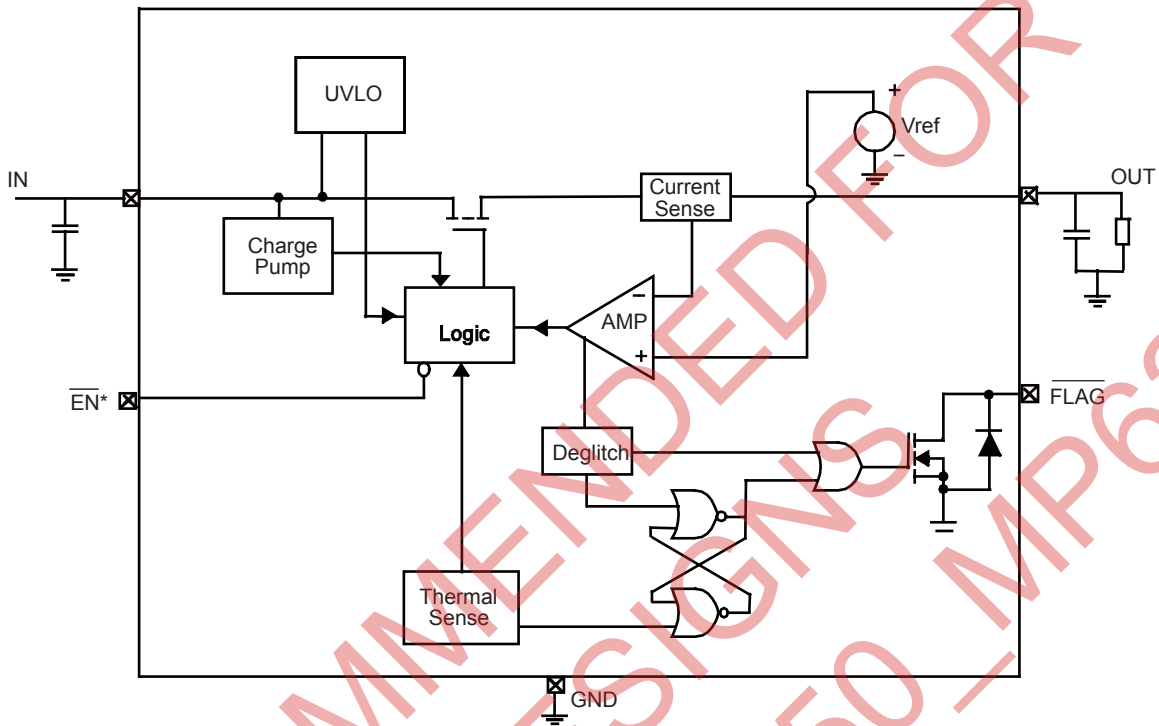

\* EN is active high for MP62171

Figure 2—Functional Block Diagram

## DETAILED DESCRIPTION

### Over Current

When the load exceeds trip current (minimum threshold current triggering constant-current mode) or a short is present, MP62170/MP62171 switches into to a constant-current mode (current limit value). MP62170/MP62171 will be shutdown only if the over current condition stays long enough to trigger thermal protection.

Trigger over current protection for different overload conditions occurring in applications:

- 1) The output has been shorted or overloaded before the device is enabled or input applied. MP62170/MP62171 detects the short or overload and immediately switches into a constant-current mode.
- 2) A short or an overload occurs after the device is enabled. After the current-limit circuit has been tripped (reached the trip current threshold), the device switches into constant-current mode. However, high current may flow for a short period of time before the current-limit circuit can react.
- 3) Output current has been gradually increased beyond the recommended operating current. The load current rises until the trip current threshold is reached or until the thermal limit of the device is exceeded. The MP62170/MP62171 is capable of delivering current up to the trip current threshold without damaging the device. Once the trip threshold has been reached, the device switches into its constant-current mode.

### Flag Response

The FLAG pin is an open drain configuration. This FAULT will report a fail mode after 8ms deglitch timeout. This is used to ensure that no false fault signals are reported. This internal deglitch circuit eliminates the need for extend components. The FLAG pin is not deglitched during over temperature of voltage lockout.

### Thermal Protection

The purpose of thermal protection is to prevent damage in the IC by allowing excessive current to flow and heating the junction. The die temperature is internally monitored until the thermal limit is reached. Once this temperature is reached, the switch will turn off and allow the chip to cool. The switch has a built-in hysteresis.

### Under-voltage Lockout (UVLO)

This circuit is used to monitor the input voltage to ensure that the MP62170/MP62171 is operating correctly. This UVLO circuit also ensures that there is no operation until the input voltage reaches the minimum spec.

### Enable

The logic pin disables the chip to reduce the supply current. The device will operate once the enable signal reaches the appropriate level. The input is compatible with both COMS and TTL.

**APPLICATION INFORMATION**

**Power-Supply Considerations**

Over 10µF capacitor between IN and GND is recommended. This precaution reduces power-supply transients that may cause ringing on the

input and improves the immunity of the device to short-circuit transients.

In order to achieve smaller output load transient, placing a high-value electrolytic capacitor on the output pin(s) is recommended when the output load is heavy.

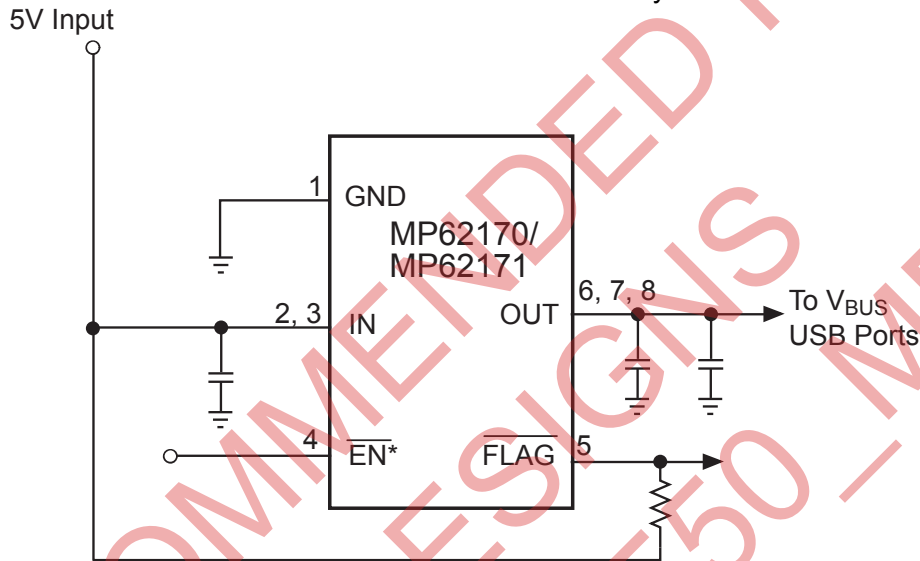

\* EN is active high for MP62171 SINGLE-CHANNEL

**Figure 3—Application Circuit**

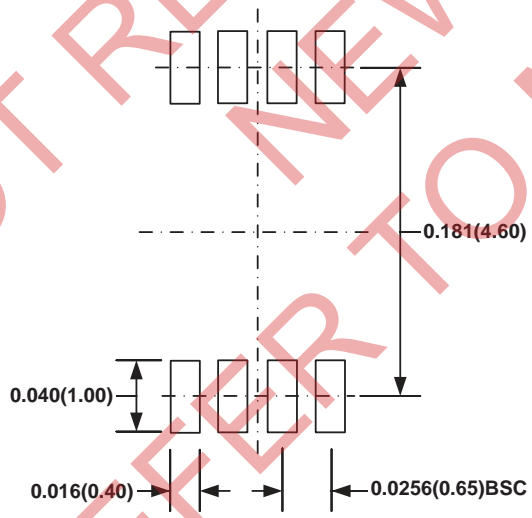
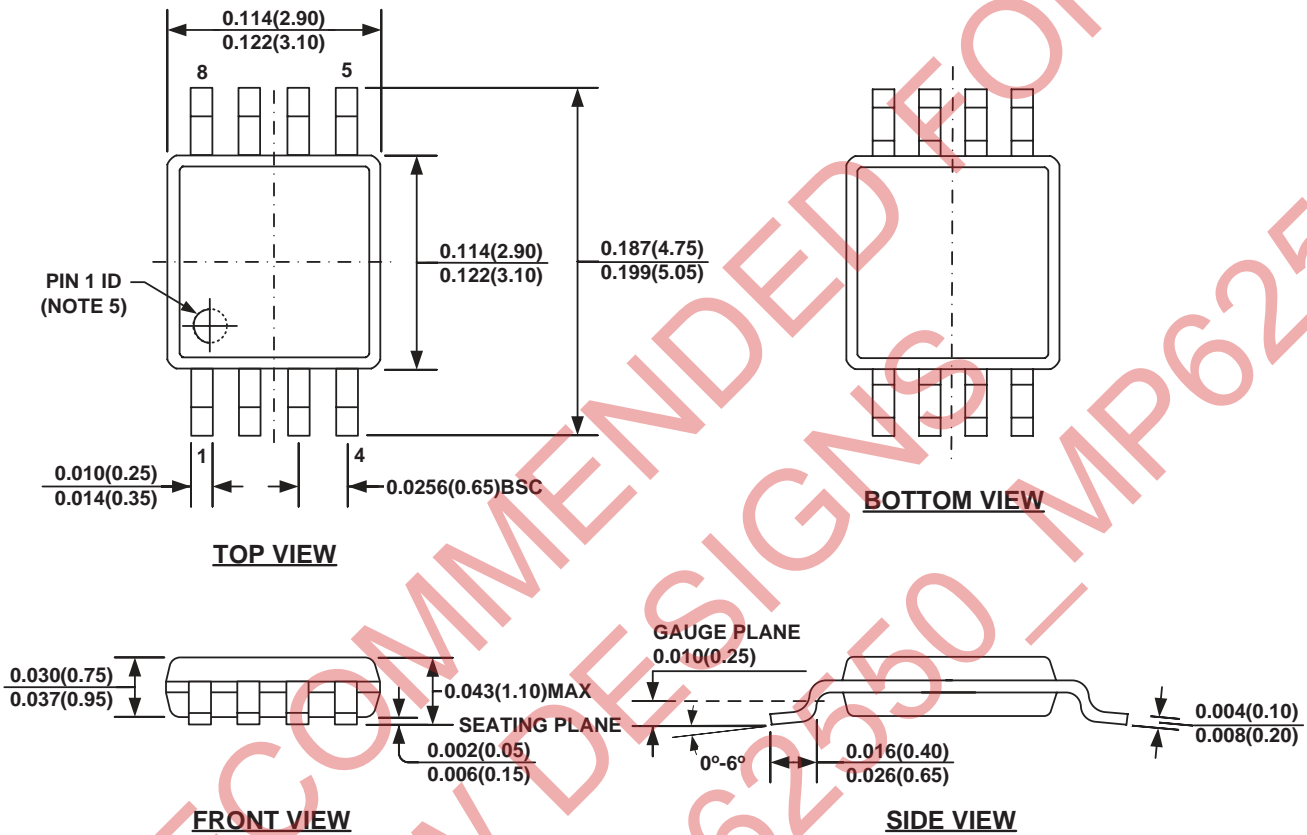
**PACKAGE INFORMATION**
**MSOP8**

**NOTE:**

- 1) CONTROL DIMENSION IS IN INCHES. DIMENSION IN BRACKET IS IN MILLIMETERS.
- 2) PACKAGE LENGTH DOES NOT INCLUDE MOLD FLASH, PROTRUSION OR GATE BURR.
- 3) PACKAGE WIDTH DOES NOT INCLUDE INTERLEAD FLASH OR PROTRUSION.
- 4) LEAD COPLANARITY (BOTTOM OF LEADS AFTER FORMING) SHALL BE 0.004" INCHES MAX.
- 5) PIN 1 IDENTIFICATION HAS HALF OR FULL CIRCLE OPTION.
- 6) DRAWING MEETS JEDEC MO-187, VARIATION AA.
- 7) DRAWING IS NOT TO SCALE.

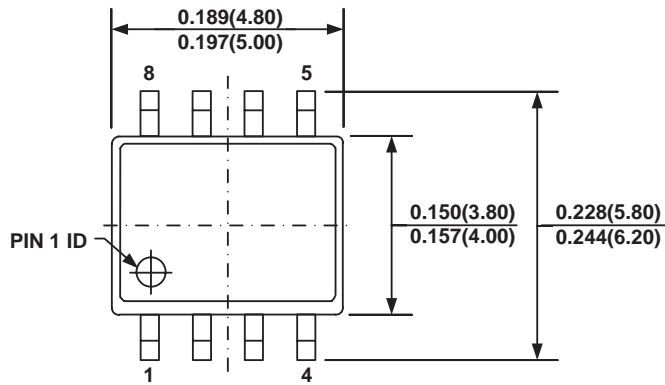
SOIC8

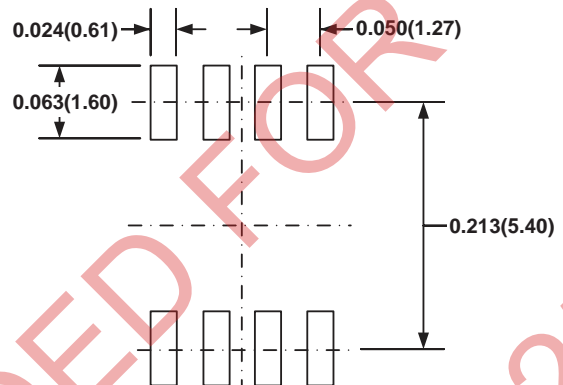

TOP VIEW



RECOMMENDED LAND PATTERN

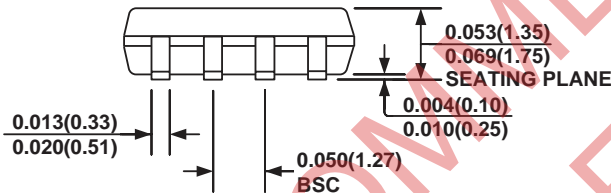

FRONT VIEW

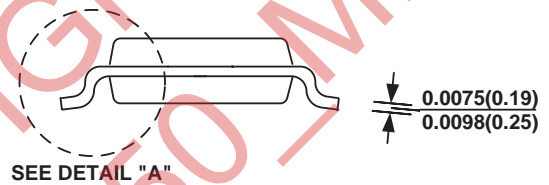

SIDE VIEW

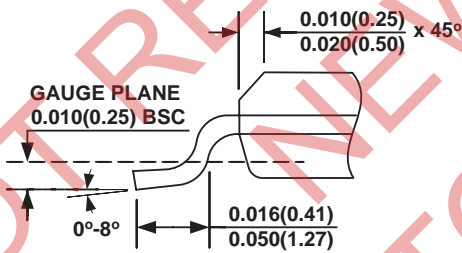

DETAIL "A"

NOTE:

- 1) CONTROL DIMENSION IS IN INCHES. DIMENSION IN BRACKET IS IN MILLIMETERS.
- 2) PACKAGE LENGTH DOES NOT INCLUDE MOLD FLASH, PROTRUSIONS OR GATE BURRS.
- 3) PACKAGE WIDTH DOES NOT INCLUDE INTERLEAD FLASH OR PROTRUSIONS.
- 4) LEAD COPLANARITY (BOTTOM OF LEADS AFTER FORMING) SHALL BE 0.004" INCHES MAX.
- 5) DRAWING CONFORMS TO JEDEC MS-012, VARIATION AA.
- 6) DRAWING IS NOT TO SCALE.

**NOTICE:** The information in this document is subject to change without notice. Users should warrant and guarantee that third party Intellectual Property rights are not infringed upon when integrating MPS products into any application. MPS will not assume any legal responsibility for any said applications.

## Looking for pricing, stock, or lifecycle information?

Click below to explore more details on WIN SOURCE:

- ⊖ [View MCP14E5-E/SN on WIN SOURCE](#)
- ⊖ [Microchip Technology](#) Information

## Optimize Your Supply Chain with WIN SOURCE Solutions

- ✓ Global Sourcing Solution
- ✓ Obsolete Management
- ✓ Cost Control Management
- ✓ Shortage Management
- ✓ Alternative Solution
- ✓ Excess Inventory Management