



**THE DATASHEET OF
MC74AC374DWR2G**



MC74AC374, MC74ACT374

Octal D-Type Flip-Flop with 3-State Outputs

The MC74AC374/74ACT374 is a high-speed, low-power octal D-type flip-flop featuring separate D-type inputs for each flip-flop and 3-state outputs for bus-oriented applications. A buffered Clock (CP) and Output Enable (\overline{OE}) are common to all flip-flops.

Features

- Buffered Positive Edge-Triggered Clock
- 3-State Outputs for Bus-Oriented Applications
- Outputs Source/Sink 24 mA
- See MC74AC273 for Reset Version
- See MC74AC377 for Clock Enable Version
- See MC74AC373 for Transparent Latch Version
- See MC74AC574 for Broadside Pinout Version
- See MC74AC564 for Broadside Pinout Version with Inverted Outputs
- 'ACT374 Has TTL Compatible Inputs
- These are Pb-Free Devices

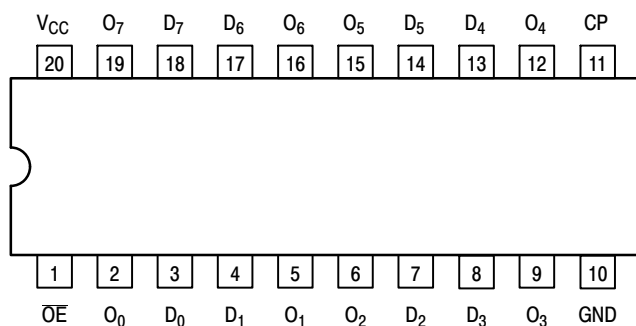

Figure 1. Pinout: 20 Lead Packages Conductors
(Top View)

PIN ASSIGNMENT

PIN	FUNCTION
D ₀ -D ₇	Data Inputs
CP	Clock Pulse Input
\overline{OE}	3-State Output Enable Input
O ₀ -O ₇	3-State Outputs



ON Semiconductor[®]

www.onsemi.com

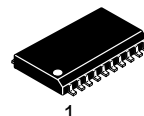

SOIC-20W
DW SUFFIX
CASE 751D

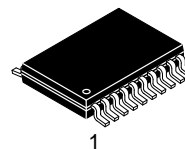

TSSOP-20
DT SUFFIX
CASE 948E

DEVICE MARKING INFORMATION

See general marking information in the device marking section on page 6 of this data sheet.

ORDERING INFORMATION

See detailed ordering and shipping information in the package dimensions section on page 8 of this data sheet.

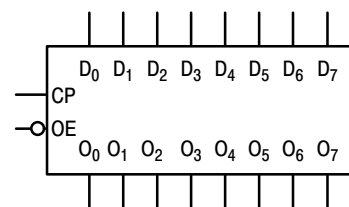

Figure 2. Logic Symbol

MC74AC374, MC74ACT374

TRUTH TABLE

Inputs			Outputs
D _n	CP	\overline{OE}	O _n
H	⌋	L	H
L	⌋	L	L
X	X	H	Z

H = HIGH Voltage Level
 L = LOW Voltage Level
 X = Immaterial
 Z = High Impedance
 ⌋ = LOW-to-HIGH Transition

FUNCTIONAL DESCRIPTION

The MC74AC374/74ACT374 consists of eight edge-triggered flip-flops with individual D-type inputs and 3-state true outputs. The buffered clock and buffered Output Enable are common to all flip-flops. The eight flip-flops will store the state of their individual D inputs that meet the setup and hold time requirements on the LOW-to-HIGH Clock (CP) transition. With the Output Enable (\overline{OE}) LOW, the contents of the eight flip-flops are available at the outputs. When the \overline{OE} is HIGH, the outputs go to the high impedance state. Operation of the \overline{OE} input does not affect the state of the flip-flops.

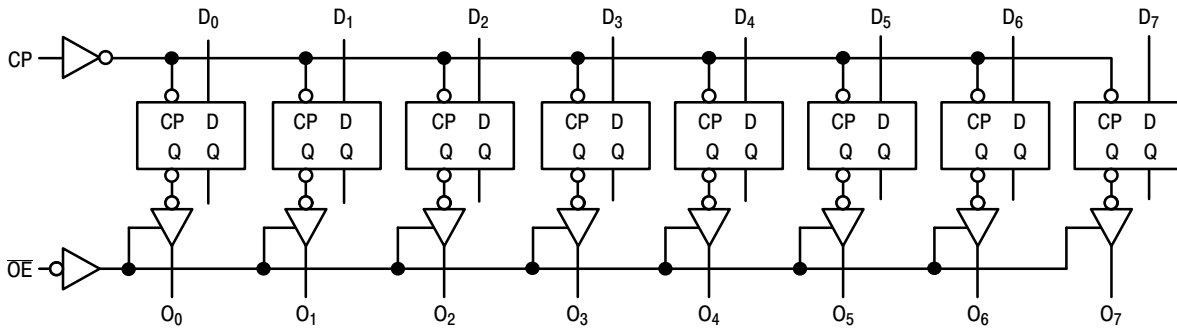

NOTE: That this diagram is provided only for the understanding of logic operations and should not be used to estimate propagation delays.

Figure 3. Logic Diagram

MC74AC374, MC74ACT374

MAXIMUM RATINGS

Symbol	Parameter	Value	Unit
V _{CC}	DC Supply Voltage (Referenced to GND)	-0.5 to +7.0	V
V _{IN}	DC Input Voltage (Referenced to GND)	-0.5 to V _{CC} +0.5	V
V _{OUT}	DC Output Voltage (Referenced to GND) (Note 1)	-0.5 to V _{CC} +0.5	V
I _{IK}	DC Input Diode Current	±20	mA
I _{OK}	DC Output Diode Current	±50	mA
I _{OUT}	DC Output Sink/Source Current	±50	mA
I _{CC}	DC Supply Current, per Output Pin	±50	mA
I _{GND}	DC Ground Current, per Output Pin	±100	mA
T _{STG}	Storage Temperature Range	-65 to +150	°C
T _L	Lead temperature, 1 mm from Case for 10 Seconds	260	°C
T _J	Junction Temperature Under Bias	140	°C
θ _{JA}	Thermal Resistance (Note 2)	SOIC TSSOP 65.8 110.7	°C/W
MSL	Moisture Sensitivity	Level 1	
F _R	Flammability Rating	Oxygen Index: 30% – 35% UL 94 V-0 @ 0.125 in	
V _{ESD}	ESD Withstand Voltage	Human Body Model (Note 3) Machine Model (Note 4) Charged Device Model (Note 5) > 2000 > 200 > 1000	V
I _{Latchup}	Latchup Performance	Above V _{CC} and Below GND at 85°C (Note 6)	±100 mA

Stresses exceeding those listed in the Maximum Ratings table may damage the device. If any of these limits are exceeded, device functionality should not be assumed, damage may occur and reliability may be affected.

1. I_{OUT} absolute maximum rating must be observed.
2. The package thermal impedance is calculated in accordance with JESD 51-7.
3. Tested to EIA/JESD22-A114-A.
4. Tested to EIA/JESD22-A115-A.
5. Tested to JESD22-C101-A.
6. Tested to EIA/JESD78.

RECOMMENDED OPERATING CONDITIONS

Symbol	Parameter	Min	Typ	Max	Unit	
V _{CC}	Supply Voltage	'AC	2.0	5.0	6.0	V
		'ACT	4.5	5.0	5.5	
V _{IN} , V _{OUT}	DC Input Voltage, Output Voltage (Ref. to GND)	0		V _{CC}	V	
t _r , t _f	Input Rise and Fall Time (Note 1) 'AC Devices except Schmitt Inputs	V _{CC} @ 3.0 V	–	150	–	ns/V
		V _{CC} @ 4.5 V	–	40	–	
		V _{CC} @ 5.5 V	–	25	–	
t _r , t _f	Input Rise and Fall Time (Note 2) 'ACT Devices except Schmitt Inputs	V _{CC} @ 4.5 V	–	10	–	ns/V
		V _{CC} @ 5.5 V	–	8.0	–	
T _A	Operating Ambient Temperature Range	-40	25	85	°C	
I _{OH}	Output Current – High	–	–	-24	mA	
I _{OL}	Output Current – Low	–	–	24	mA	

Functional operation above the stresses listed in the Recommended Operating Ranges is not implied. Extended exposure to stresses beyond the Recommended Operating Ranges limits may affect device reliability.

1. V_{IN} from 30% to 70% V_{CC}; see individual Data Sheets for devices that differ from the typical input rise and fall times.
2. V_{IN} from 0.8 V to 2.0 V; see individual Data Sheets for devices that differ from the typical input rise and fall times.

MC74AC374, MC74ACT374

DC CHARACTERISTICS

Symbol	Parameter	V _{CC} (V)	74AC		74AC		Unit	Conditions
			T _A = +25°C		T _A = -40°C to +85°C			
			Typ	Guaranteed Limits				
V _{IH}	Minimum High Level Input Voltage	3.0	1.5	2.1	2.1		V	V _{OUT} = 0.1 V or V _{CC} - 0.1 V
		4.5	2.25	3.15	3.15			
		5.5	2.75	3.85	3.85			
V _{IL}	Maximum Low Level Input Voltage	3.0	1.5	0.9	0.9		V	V _{OUT} = 0.1 V or V _{CC} - 0.1 V
		4.5	2.25	1.35	1.35			
		5.5	2.75	1.65	1.65			
V _{OH}	Minimum High Level Output Voltage	3.0	2.99	2.9	2.9		V	I _{OUT} = -50 μA
		4.5	4.49	4.4	4.4			
		5.5	5.49	5.4	5.4			
		3.0	-	2.56	2.46		V	*V _{IN} = V _{IL} or V _{IH} -12 mA I _{OH} -24 mA -24 mA
		4.5	-	3.86	3.76			
		5.5	-	4.86	4.76			
V _{OL}	Maximum Low Level Output Voltage	3.0	0.002	0.1	0.1		V	I _{OUT} = 50 μA
		4.5	0.001	0.1	0.1			
		5.5	0.001	0.1	0.1			
		3.0	-	0.36	0.44		V	*V _{IN} = V _{IL} or V _{IH} 12 mA I _{OL} 24 mA 24 mA
		4.5	-	0.36	0.44			
		5.5	-	0.36	0.44			
I _{IN}	Maximum Input Leakage Current	5.5	-	±0.1	±1.0		μA	V _I = V _{CC} , GND
I _{OZ}	Maximum 3-State Current	5.5	-	±0.5	±5.0		μA	V _I (OE) = V _{IL} , V _{IH} V _I = V _{CC} , GND V _O = V _{CC} , GND
I _{OLD}	†Minimum Dynamic Output Current	5.5	-	-	75		mA	V _{OLD} = 1.65 V Max
I _{OHD}		5.5	-	-	-75		mA	V _{OHD} = 3.85 V Min
I _{CC}	Maximum Quiescent Supply Current	5.5	-	8.0	80		μA	V _{IN} = V _{CC} or GND

*All outputs loaded; thresholds on input associated with output under test.

†Maximum test duration 2.0 ms, one output loaded at a time.

NOTE: I_{IN} and I_{CC} @ 3.0 V are guaranteed to be less than or equal to the respective limit @ 5.5 V V_{CC}.

MC74AC374, MC74ACT374

AC CHARACTERISTICS (For Figures and Waveforms – See AND8277/D at www.onsemi.com)

Symbol	Parameter	V _{CC} * (V)	74AC			74AC		Unit	Fig. No.
			T _A = +25°C C _L = 50 pF			T _A = -40°C to +85°C C _L = 50 pF			
			Min	Typ	Max	Min	Max		
f _{max}	Maximum Clock Frequency	3.3 5.0	60 100	110 155	– –	60 100	– –	MHz	3–3
t _{PLH}	Propagation Delay CP to O _n	3.3 5.0	3.0 2.5	11 8.0	13.5 9.5	1.5 1.5	15.5 10.5	ns	3–6
t _{PHL}	Propagation Delay CP to O _n	3.3 5.0	2.5 2.0	10 7.0	12.5 9.0	2.0 1.5	14 10	ns	3–6
t _{PZH}	Output Enable Time	3.3 5.0	3.0 2.0	9.5 7.0	11.5 8.5	1.5 1.0	13 9.5	ns	3–7
t _{PZL}	Output Enable Time	3.3 5.0	2.5 2.0	9.0 6.5	11.5 8.5	1.5 1.0	13 9.5	ns	3–8
t _{PHZ}	Output Disable Time	3.3 5.0	3.0 2.0	10.5 8.0	12.5 11	2.0 2.0	14.5 12.5	ns	3–7
t _{PLZ}	Output Disable Time	3.3 5.0	2.0 1.5	8.0 6.5	11.5 8.5	1.0 1.0	12.5 10	ns	3–8

*Voltage Range 3.3 V is 3.3 V ±0.3 V.
Voltage Range 5.0 V is 5.0 V ±0.5 V.

AC OPERATING REQUIREMENTS

Symbol	Parameter	V _{CC} * (V)	74AC		74AC		Unit	Fig. No.
			T _A = +25°C C _L = 50 pF		T _A = -40°C to +85°C C _L = 50 pF			
			Typ	Guaranteed Minimum				
t _s	Setup Time, HIGH or LOW D _n to CP	3.3 5.0	2.0 1.0	5.5 4.0	6.0 4.5	ns	3–9	
t _h	Hold Time, HIGH or LOW D _n to CP	3.3 5.0	-1.0 0	1.0 1.5	1.0 1.5	ns	3–9	
t _w	CP Pulse Width HIGH or LOW	3.3 5.0	4.0 2.5	5.5 4.0	6.0 4.5	ns	3–6	

*Voltage Range 3.3 V is 3.3 V ±0.3 V.
Voltage Range 5.0 V is 5.0 V ±0.5 V.

MC74AC374, MC74ACT374

DC CHARACTERISTICS

Symbol	Parameter	V _{CC} (V)	74ACT		74ACT		Unit	Conditions
			T _A = +25°C		T _A = -40°C to +85°C			
			Typ	Guaranteed Limits				
V _{IH}	Minimum High Level Input Voltage	4.5	1.5	2.0	2.0		V	V _{OUT} = 0.1 V or V _{CC} - 0.1 V
		5.5	1.5	2.0	2.0			
V _{IL}	Maximum Low Level Input Voltage	4.5	1.5	0.8	0.8		V	V _{OUT} = 0.1 V or V _{CC} - 0.1 V
		5.5	1.5	0.8	0.8			
V _{OH}	Minimum High Level Output Voltage	4.5	4.49	4.4	4.4		V	I _{OUT} = -50 μA
		5.5	5.49	5.4	5.4			
		4.5	-	3.86	3.76		V	*V _{IN} = V _{IL} or V _{IH} I _{OH} -24 mA -24 mA
		5.5	-	4.86	4.76			
V _{OL}	Maximum Low Level Output Voltage	4.5	0.001	0.1	0.1		V	I _{OUT} = 50 μA
		5.5	0.001	0.1	0.1			
		4.5	-	0.36	0.44		V	*V _{IN} = V _{IL} or V _{IH} I _{OL} 24 mA 24 mA
		5.5	-	0.36	0.44			
I _{IN}	Maximum Input Leakage Current	5.5	-	±0.1	±1.0		μA	V _I = V _{CC} , GND
ΔI _{CCT}	Additional Max. I _{CC} /Input	5.5	0.6	-	1.5		mA	V _I = V _{CC} - 2.1 V
I _{OZ}	Maximum 3-State Current	5.5	-	±0.5	±5.0		μA	V _I (OE) = V _{IL} , V _{IH} V _I = V _{CC} , GND V _O = V _{CC} , GND
I _{OLD}	†Minimum Dynamic Output Current	5.5	-	-	75		mA	V _{OLD} = 1.65 V Max
I _{OHD}		5.5	-	-	-75		mA	V _{OHD} = 3.85 V Min
I _{CC}	Maximum Quiescent Supply Current	5.5	-	8.0	80		μA	V _{IN} = V _{CC} or GND

*All outputs loaded; thresholds on input associated with output under test.

†Maximum test duration 2.0 ms, one output loaded at a time.

AC CHARACTERISTICS (For Figures and Waveforms – See AND8277/D at www.onsemi.com)

Symbol	Parameter	V _{CC} * (V)	74ACT			74ACT		Unit	Fig. No.
			T _A = +25°C C _L = 50 pF			T _A = -40°C to +85°C C _L = 50 pF			
			Min	Typ	Max	Min	Max		
f _{max}	Maximum Clock Frequency	5.0	100	160	-	90	-	MHz	3-3
t _{PLH}	Propagation Delay CP to O _n	5.0	2.0	8.5	10	2.0	11.5	ns	3-6
t _{PHL}	Propagation Delay CP to O _n	5.0	2.0	8.0	9.5	1.5	11	ns	3-6
t _{PZH}	Output Enable Time	5.0	2.0	8.0	9.5	1.5	10.5	ns	3-7
t _{PZL}	Output Enable Time	5.0	1.5	8.0	9.0	1.5	10.5	ns	3-8
t _{PHZ}	Output Disable Time	5.0	1.5	8.5	11.5	1.0	12.5	ns	3-7
t _{PLZ}	Output Disable Time	5.0	1.5	7.0	8.5	1.0	10	ns	3-8

*Voltage Range 5.0 V is 5.0 V ±0.5 V.

MC74AC374, MC74ACT374

AC OPERATING REQUIREMENTS (For Figures and Waveforms – See AND8277/D at www.onsemi.com)

Symbol	Parameter	V _{CC} * (V)	74ACT		74ACT		Unit	Fig. No.
			T _A = +25°C C _L = 50 pF		T _A = -40°C to +85°C C _L = 50 pF			
			Typ	Guaranteed Minimum				
t _s	Setup Time, HIGH or LOW D _n to CP	5.0	1.0	5.0	5.5	ns	3-9	
t _h	Hold Time, HIGH or LOW D _n to CP	5.0	0	1.5	1.5	ns	3-9	
t _w	CP Pulse Width HIGH or LOW	5.0	2.5	5.0	5.0	ns	3-6	

*Voltage Range 5.0 V is 5.0 V ±0.5 V.

CAPACITANCE

Symbol	Parameter	Value Typ	Unit	Test Conditions
C _{IN}	Input Capacitance	4.5	pF	V _{CC} = 5.0 V
C _{PD}	Power Dissipation Capacitance	80	pF	V _{CC} = 5.0 V

MARKING DIAGRAMS

SOIC-20W

TSSOP-20

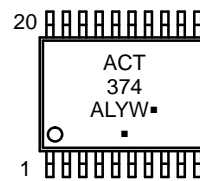
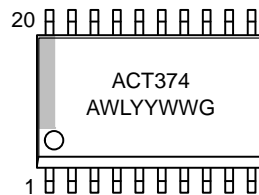
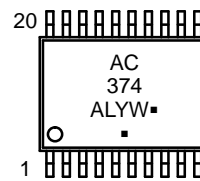
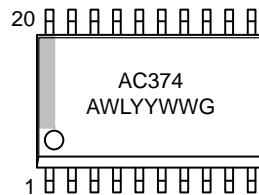

A = Assembly Location
 WL, L = Wafer Lot
 YY, Y = Year
 WW, W = Work Week
 G or ■ = Pb-Free Package
 (Note: Microdot may be in either location)

MC74AC374, MC74ACT374

ORDERING INFORMATION

Device	Package	Shipping†
MC74AC374DWG	SOIC-20 (Pb-Free)	38 Units / Rail
MC74AC374DWR2G	SOIC-20 (Pb-Free)	1000 / Tape & Reel
MC74ACT374DWG	SOIC-20 (Pb-Free)	38 Units / Rail
MC74ACT374DWR2G	SOIC-20 (Pb-Free)	1000 / Tape & Reel
MC74AC374DTR2G	TSSOP-20 (Pb-Free)	2500 / Tape & Reel
MC74ACT374DTR2G	TSSOP-20 (Pb-Free)	2500 / Tape & Reel

†For information on tape and reel specifications, including part orientation and tape sizes, please refer to our Tape and Reel Packaging Specifications Brochure, BRD8011/D.

MC74AC374, MC74ACT374

PACKAGE DIMENSIONS

TSSOP-20
DT SUFFIX
CASE 948E-02
ISSUE C

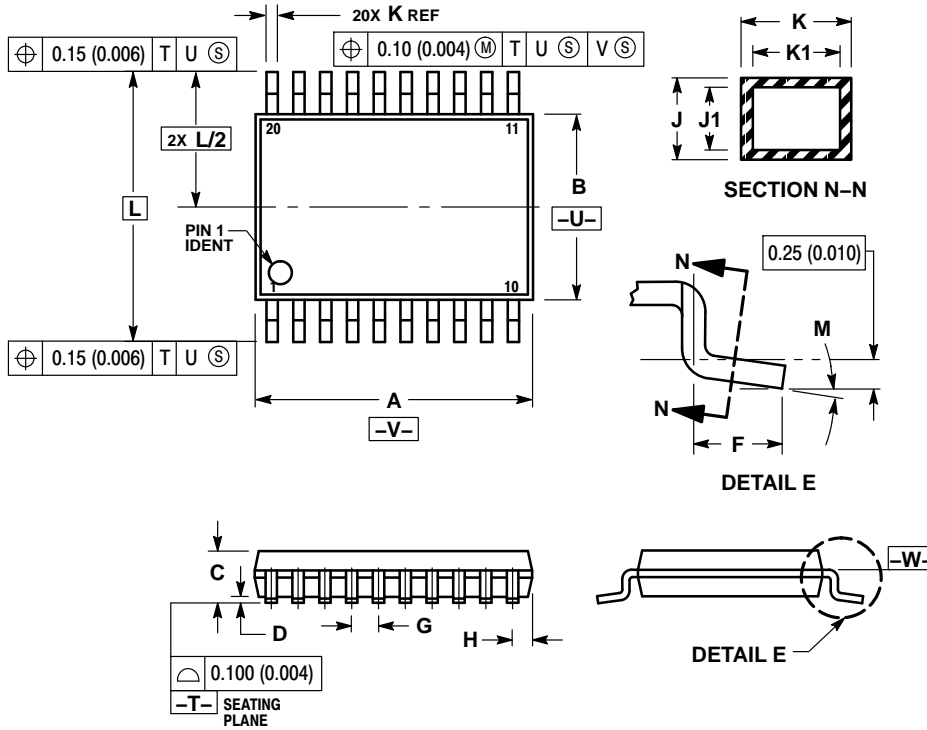

NOTES:

1. DIMENSIONING AND TOLERANCING PER ANSI Y14.5M, 1982.
2. CONTROLLING DIMENSION: MILLIMETER.
3. DIMENSION A DOES NOT INCLUDE MOLD FLASH, PROTRUSIONS OR GATE BURRS. MOLD FLASH OR GATE BURRS SHALL NOT EXCEED 0.15 (0.006) PER SIDE.
4. DIMENSION B DOES NOT INCLUDE INTERLEAD FLASH OR PROTRUSION. INTERLEAD FLASH OR PROTRUSION SHALL NOT EXCEED 0.25 (0.010) PER SIDE.
5. DIMENSION K DOES NOT INCLUDE DAMBAR PROTRUSION. ALLOWABLE DAMBAR PROTRUSION SHALL BE 0.08 (0.003) TOTAL IN EXCESS OF THE K DIMENSION AT MAXIMUM MATERIAL CONDITION.
6. TERMINAL NUMBERS ARE SHOWN FOR REFERENCE ONLY.
7. DIMENSION A AND B ARE TO BE DETERMINED AT DATUM PLANE -W-.

DIM	MILLIMETERS		INCHES	
	MIN	MAX	MIN	MAX
A	6.40	6.60	0.252	0.260
B	4.30	4.50	0.169	0.177
C	---	1.20	---	0.047
D	0.05	0.15	0.002	0.006
F	0.50	0.75	0.020	0.030
G	0.65 BSC		0.026 BSC	
H	0.27	0.37	0.011	0.015
J	0.09	0.20	0.004	0.008
J1	0.09	0.16	0.004	0.006
K	0.19	0.30	0.007	0.012
K1	0.19	0.25	0.007	0.010
L	6.40 BSC		0.252 BSC	
M	0°	8°	0°	8°

SOLDERING FOOTPRINT*

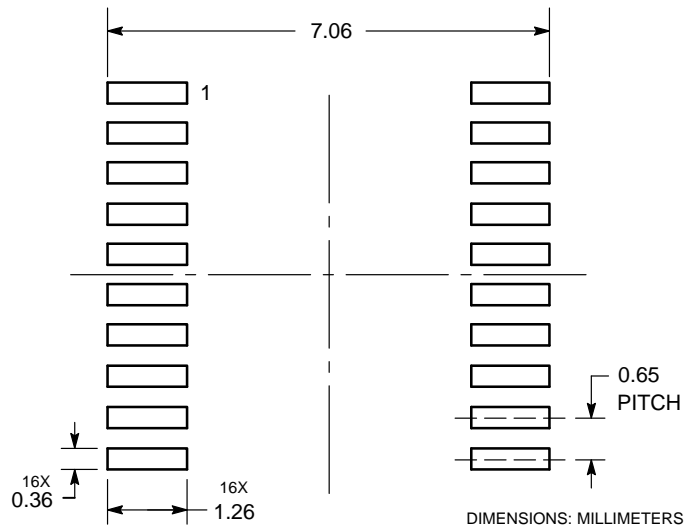

*For additional information on our Pb-Free strategy and soldering details, please download the ON Semiconductor Soldering and Mounting Techniques Reference Manual, SOLDERRM/D.

MC74AC374, MC74ACT374

PACKAGE DIMENSIONS

SOIC-20W
DW SUFFIX
CASE 751D-05
ISSUE G

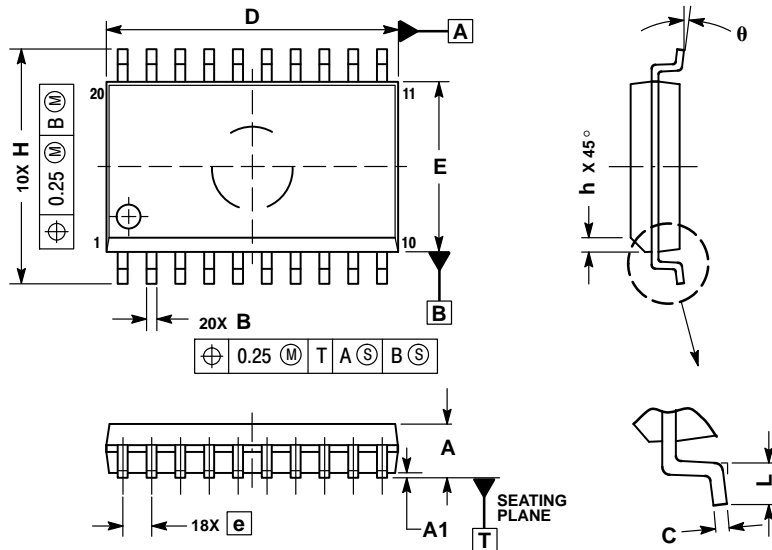

NOTES:

1. DIMENSIONS ARE IN MILLIMETERS.
2. INTERPRET DIMENSIONS AND TOLERANCES PER ASME Y14.5M, 1994.
3. DIMENSIONS D AND E DO NOT INCLUDE MOLD PROTRUSION.
4. MAXIMUM MOLD PROTRUSION 0.15 PER SIDE.
5. DIMENSION B DOES NOT INCLUDE DAMBAR PROTRUSION. ALLOWABLE PROTRUSION SHALL BE 0.13 TOTAL IN EXCESS OF B DIMENSION AT MAXIMUM MATERIAL CONDITION.

DIM	MILLIMETERS	
	MIN	MAX
A	2.35	2.65
A1	0.10	0.25
B	0.35	0.49
C	0.23	0.32
D	12.65	12.95
E	7.40	7.60
e	1.27 BSC	
H	10.05	10.55
h	0.25	0.75
L	0.50	0.90
θ	0°	7°

ON Semiconductor and the  are registered trademarks of Semiconductor Components Industries, LLC (SCILLC) or its subsidiaries in the United States and/or other countries. SCILLC owns the rights to a number of patents, trademarks, copyrights, trade secrets, and other intellectual property. A listing of SCILLC's product/patent coverage may be accessed at www.onsemi.com/site/pdf/Patent-Marking.pdf. SCILLC reserves the right to make changes without further notice to any products herein. SCILLC makes no warranty, representation or guarantee regarding the suitability of its products for any particular purpose, nor does SCILLC assume any liability arising out of the application or use of any product or circuit, and specifically disclaims any and all liability, including without limitation special, consequential or incidental damages. "Typical" parameters which may be provided in SCILLC data sheets and/or specifications can and do vary in different applications and actual performance may vary over time. All operating parameters, including "Typicals" must be validated for each customer application by customer's technical experts. SCILLC does not convey any license under its patent rights nor the rights of others. SCILLC products are not designed, intended, or authorized for use as components in systems intended for surgical implant into the body, or other applications intended to support or sustain life, or for any other application in which the failure of the SCILLC product could create a situation where personal injury or death may occur. Should Buyer purchase or use SCILLC products for any such unintended or unauthorized application, Buyer shall indemnify and hold SCILLC and its officers, employees, subsidiaries, affiliates, and distributors harmless against all claims, costs, damages, and expenses, and reasonable attorney fees arising out of, directly or indirectly, any claim of personal injury or death associated with such unintended or unauthorized use, even if such claim alleges that SCILLC was negligent regarding the design or manufacture of the part. SCILLC is an Equal Opportunity/Affirmative Action Employer. This literature is subject to all applicable copyright laws and is not for resale in any manner.

PUBLICATION ORDERING INFORMATION

LITERATURE FULFILLMENT:

Literature Distribution Center for ON Semiconductor
P.O. Box 5163, Denver, Colorado 80217 USA
Phone: 303-675-2175 or 800-344-3860 Toll Free USA/Canada
Fax: 303-675-2176 or 800-344-3867 Toll Free USA/Canada
Email: orderlit@onsemi.com

N. American Technical Support: 800-282-9855 Toll Free
USA/Canada
Europe, Middle East and Africa Technical Support:
Phone: 421 33 790 2910
Japan Customer Focus Center
Phone: 81-3-5817-1050

ON Semiconductor Website: www.onsemi.com

Order Literature: <http://www.onsemi.com/orderlit>

For additional information, please contact your local Sales Representative

MC74AC374/D

Looking for pricing, stock, or lifecycle information?

Click below to explore more details on WIN SOURCE:

- ⊖ [View MC74AC374DWR2G on WIN SOURCE](#)
- ⊖ [ON Semiconductor Information](#)

Optimize Your Supply Chain with WIN SOURCE Solutions

- ✓ Global Sourcing Solution
- ✓ Obsolete Management
- ✓ Cost Control Management
- ✓ Shortage Management
- ✓ Alternative Solution
- ✓ Excess Inventory Management