



**THE DATASHEET OF
MC14049UBFELG**



MC14049UB

Hex Buffers

The MC14049UB hex inverter/buffer is constructed with MOS P-channel and N-channel enhancement mode devices in a single monolithic structure. This complementary MOS device finds primary use where low power dissipation and/or high noise immunity is desired. This device provides logic-level conversion using only one supply voltage, V_{DD} . The input-signal high level (V_{IH}) can exceed the V_{DD} supply voltage for logic-level conversions. Two TTL/DTL Loads can be driven when the device is used as CMOS-to-TTL/DTL converters ($V_{DD} = 5.0\text{ V}$, $V_{OL} \leq 0.4\text{ V}$, $I_{OL} \geq 3.2\text{ mA}$). Note that pins 13 and 16 are not connected internally on this device; consequently connections to these terminals will not affect circuit operation.

Features

- High Source and Sink Currents
- High-to-Low Level Converter
- Supply Voltage Range = 3.0 V to 18 V
- Meets JEDEC UB Specifications
- V_{IN} can exceed V_{DD}
- Improved ESD Protection on All Inputs
- These Devices are Pb-Free and are RoHS Compliant
- NLV Prefix for Automotive and Other Applications Requiring Unique Site and Control Change Requirements; AEC-Q100 Qualified and PPAP Capable

MAXIMUM RATINGS (Voltages Referenced to V_{SS})

Symbol	Parameter	Value	Unit
V_{DD}	DC Supply Voltage Range	-0.5 to +18.0	V
V_{in}	Input Voltage Range (DC or Transient)	-0.5 to +18.0	V
V_{out}	Output Voltage Range (DC or Transient)	-0.5 to V_{DD} +0.5	V
I_{in}	Input Current (DC or Transient) per Pin	± 10	mA
I_{out}	Output Current (DC or Transient) per Pin	+45	mA
P_D	Power Dissipation, per Package (Note 1)	825 740	mW
T_A	Ambient Temperature Range	-55 to +125	$^{\circ}\text{C}$
T_{stg}	Storage Temperature Range	-65 to +150	$^{\circ}\text{C}$
T_L	Lead Temperature (8-Second Soldering)	260	$^{\circ}\text{C}$

Stresses exceeding those listed in the Maximum Ratings table may damage the device. If any of these limits are exceeded, device functionality should not be assumed, damage may occur and reliability may be affected.

1. Temperature Derating: All Packages: See Figure 4.

This device contains circuitry to protect the inputs against damage due to high static voltages or electric fields referenced to the V_{SS} pin, only. Extra precautions must be taken to avoid applications of any voltage higher than the maximum rated voltages to this high-impedance circuit. For proper operation, the ranges $V_{SS} \leq V_{in} \leq 18\text{ V}$ and $V_{SS} \leq V_{out} \leq V_{DD}$ are recommended.

Unused inputs must always be tied to an appropriate logic voltage level (e.g., either V_{SS} or V_{DD}). Unused outputs must be left open.



ON Semiconductor®

www.onsemi.com

MARKING DIAGRAMS

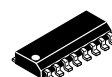

SOIC-16
D SUFFIX
CASE 751B

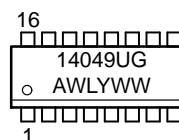

TSSOP-16
DT SUFFIX
CASE 948F

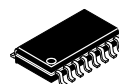
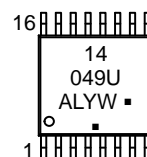

SOEIAJ-16
F SUFFIX
CASE 966

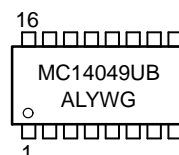

A = Assembly Location
WL, L = Wafer Lot
YY, Y = Year
WW, W = Work Week
G or ■ = Pb-Free Package

(Note: Microdot may be in either location)

ORDERING INFORMATION

See detailed ordering and shipping information in the package dimensions section on page 3 of this data sheet.

MC14049UB

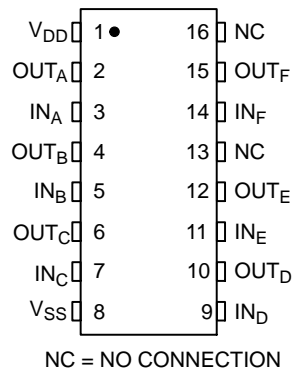

Figure 1. Pin Assignment

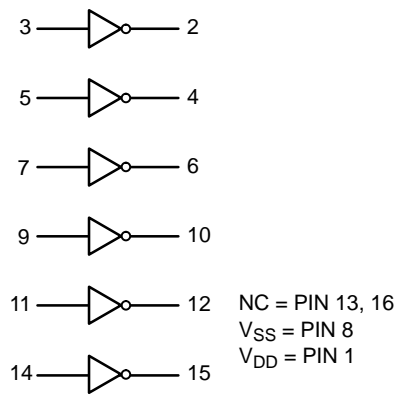

Figure 2. Logic Diagram
MC14049UB

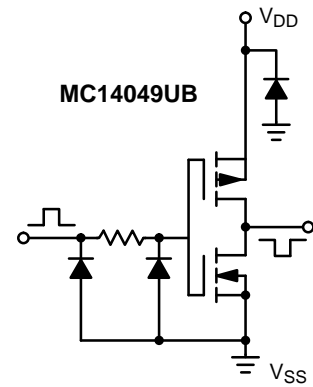

Figure 3. Circuit Schematic
(1/6 of circuit shown)

ELECTRICAL CHARACTERISTICS (Voltages Referenced to V_{SS})

Characteristic	Symbol	V _{DD} Vdc	- 55°C		25°C			125°C		Unit	
			Min	Max	Min	Typ (Note 2)	Max	Min	Max		
Output Voltage V _{in} = V _{DD} or 0	“0” Level	V _{OL}	5.0	-	0.05	-	0	0.05	-	0.05	Vdc
			10	-	0.05	-	0	0.05	-	0.05	
15	-		0.05	-	0	0.05	-	0.05			
V _{in} = 0 or V _{DD}	“1” Level	V _{OH}	5.0	4.95	-	4.95	5.0	-	4.95	-	Vdc
			10	9.95	-	9.95	10	-	9.95	-	
			15	14.95	-	14.95	15	-	14.95	-	
Input Voltage (V _O = 4.5 Vdc) (V _O = 9.0 Vdc) (V _O = 13.5 Vdc)	“0” Level	V _{IL}	5.0	-	1.0	-	2.25	1.0	-	1.0	Vdc
			10	-	2.0	-	4.50	2.0	-	2.0	
			15	-	2.5	-	6.75	2.5	-	2.5	
	“1” Level	V _{IH}	5.0	4.0	-	4.0	2.75	-	4.0	-	Vdc
			10	8.0	-	8.0	5.50	-	8.0	-	
			15	12.5	-	12.5	8.25	-	12.5	-	
Output Drive Current (V _{OH} = 2.5 Vdc) (V _{OH} = 9.5 Vdc) (V _{OH} = 13.5 Vdc)	Source	I _{OH}	5.0	-1.6	-	-1.25	-2.5	-	-1.0	-	mA _{dc}
			10	-1.6	-	-1.3	-2.6	-	-1.0	-	
			15	-4.7	-	-3.75	-10	-	-3.0	-	
	Sink	I _{OL}	5.0	3.75	-	3.2	6.0	-	2.6	-	mA _{dc}
			10	10	-	8.0	16	-	6.6	-	
			15	30	-	24	40	-	19	-	
Input Current	I _{in}	15	-	± 0.1	-	± 0.000 01	± 0.1	-	± 1.0	μA _{dc}	
Input Capacitance (V _{in} = 0)	C _{in}	-	-	-	-	10	20	-	-	pF	
Quiescent Current (Per Package)	I _{DD}	5.0	-	1.0	-	0.002	1.0	-	30	μA _{dc}	
		10	-	2.0	-	0.004	2.0	-	60		
		15	-	4.0	-	0.006	4.0	-	120		
Total Supply Current (Note 3 and 4) (Dynamic plus Quiescent, Per Package) (C _L = 50 pF on all outputs, all buffers switching)	I _T	5.0	I _T = (1.8 μA/kHz) f + I _{DD}							μA _{dc}	
		10	I _T = (3.5 μA/kHz) f + I _{DD}								
		15	I _T = (5.3 μA/kHz) f + I _{DD}								

2. Data labelled “Typ” is not to be used for design purposes but is intended as an indication of the IC’s potential performance.

3. The formulas given are for the typical characteristics only at 25°C.

4. To calculate total supply current at loads other than 50 pF:

$$I_T(C_L) = I_T(50 \text{ pF}) + (C_L - 50) Vfk$$

where: I_T is in μA (per package), C_L in pF, V = (V_{DD} - V_{SS}) in volts, f in kHz is input frequency, and k = 0.002.

MC14049UB

SWITCHING CHARACTERISTICS (Note 5) ($C_L = 50 \text{ pF}$, $T_A = 25^\circ\text{C}$)

Characteristic	Symbol	V_{DD} Vdc	Min	Typ (Note 6)	Max	Unit
Output Rise Time $t_{TLH} = (0.8 \text{ ns/pF}) C_L + 60 \text{ ns}$ $t_{TLH} = (0.3 \text{ ns/pF}) C_L + 35 \text{ ns}$ $t_{TLH} = (0.27 \text{ ns/pF}) C_L + 26.5 \text{ ns}$	t_{TLH}	5.0 10 15	- - -	100 50 40	160 100 60	ns
Output Fall Time $t_{THL} = (0.3 \text{ ns/pF}) C_L + 25 \text{ ns}$ $t_{THL} = (0.12 \text{ ns/pF}) C_L + 14 \text{ ns}$ $t_{THL} = (0.1 \text{ ns/pF}) C_L + 10 \text{ ns}$	t_{THL}	5.0 10 15	- - -	40 20 15	60 40 30	ns
Propagation Delay Time $t_{PLH} = (0.38 \text{ ns/pF}) C_L + 61 \text{ ns}$ $t_{PLH} = (0.20 \text{ ns/pF}) C_L + 30 \text{ ns}$ $t_{PLH} = (0.11 \text{ ns/pF}) C_L + 24.5 \text{ ns}$	t_{PLH}	5.0 10 15	- - -	80 40 30	120 65 50	ns
Propagation Delay Time $t_{PHL} = (0.38 \text{ ns/pF}) C_L + 11 \text{ ns}$ $t_{PHL} = (0.12 \text{ ns/pF}) C_L + 9 \text{ ns}$ $t_{PHL} = (0.11 \text{ ns/pF}) C_L + 4.5 \text{ ns}$	t_{PHL}	5.0 10 15	- - -	30 15 10	60 30 20	ns

5. The formulas given are for the typical characteristics only at 25°C .

6. Data labelled "Typ" is not to be used for design purposes but is intended as an indication of the IC's potential performance.

ORDERING INFORMATION

Device	Package	Shipping†
MC14049UBDG	SOIC-16 (Pb-Free)	48 Units / Rail
NLV14049UBDG*		
MC14049UBDR2G	SOIC-16 (Pb-Free)	2500 / Tape & Reel
NLV14049UBDR2G*		
MC14049UBDTR2G	TSSOP-16 (Pb-Free)	2500 / Tape & Reel
MC14049UBFELG	SOEIAJ-16 (Pb-Free)	2000 / Tape & Reel

†For information on tape and reel specifications, including part orientation and tape sizes, please refer to our Tape and Reel Packaging Specifications Brochure, BRD8011/D.

*NLV Prefix for Automotive and Other Applications Requiring Unique Site and Control Change Requirements; AEC-Q100 Qualified and PPAP Capable.

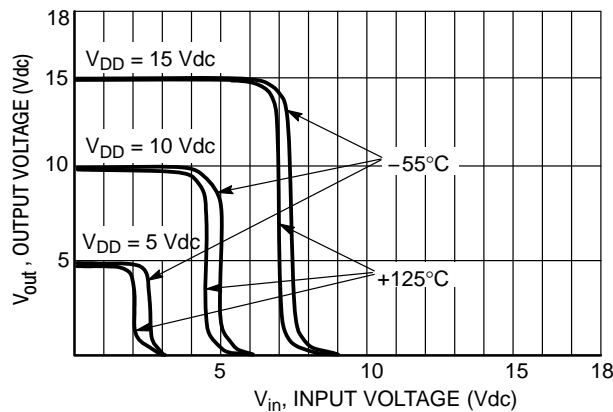

Figure 4. Typical Voltage Transfer Characteristics versus Temperature

MC14049UB

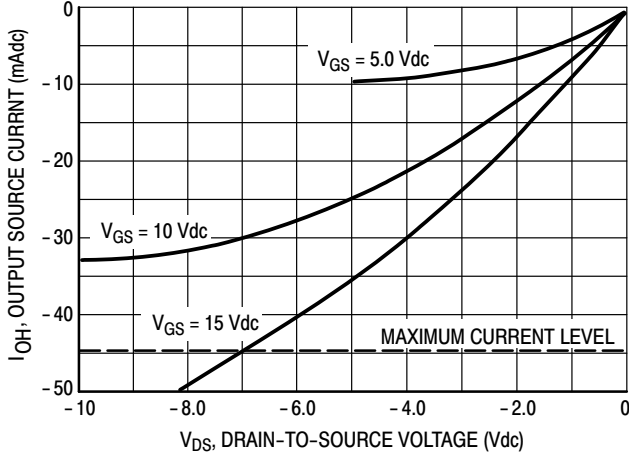
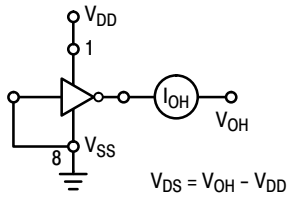

Figure 5. Typical Output Source Characteristics

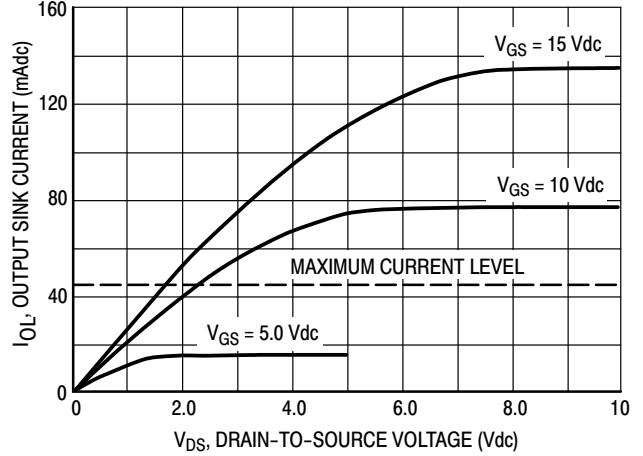
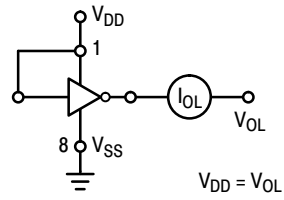

Figure 6. Typical Output Sink Characteristics

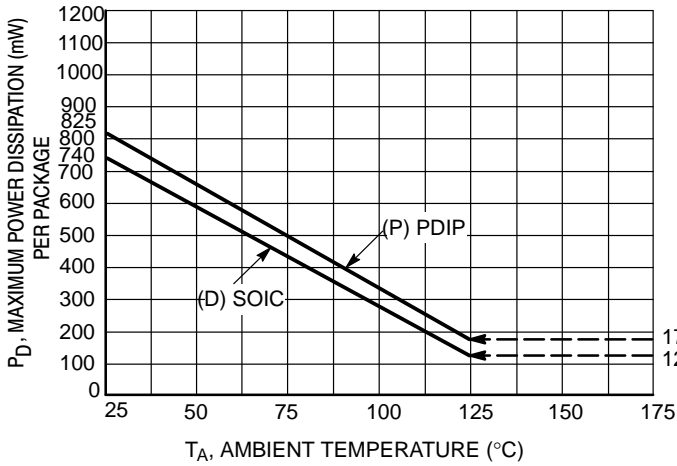

Figure 7. Ambient Temperature Power Derating

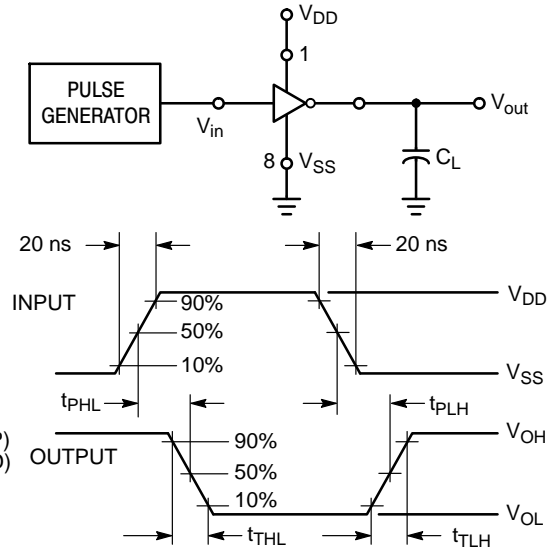
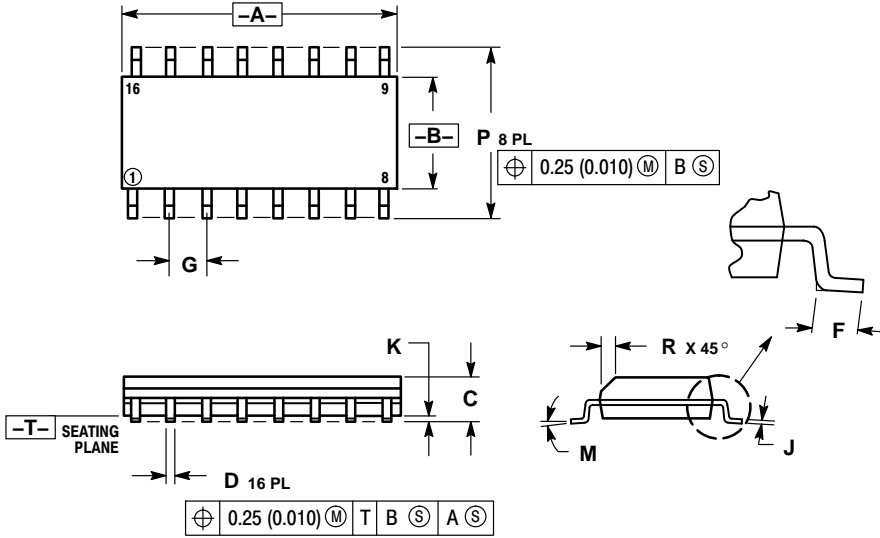

Figure 8. Switching Time Test Circuit and Waveforms

MC14049UB

PACKAGE DIMENSIONS

SOIC-16
D SUFFIX
CASE 751B-05
ISSUE K



NOTES:

1. DIMENSIONING AND TOLERANCING PER ANSI Y14.5M, 1982.
2. CONTROLLING DIMENSION: MILLIMETER.
3. DIMENSIONS A AND B DO NOT INCLUDE MOLD PROTRUSION.
4. MAXIMUM MOLD PROTRUSION 0.15 (0.006) PER SIDE.
5. DIMENSION D DOES NOT INCLUDE DAMBAR PROTRUSION. ALLOWABLE DAMBAR PROTRUSION SHALL BE 0.127 (0.005) TOTAL IN EXCESS OF THE D DIMENSION AT MAXIMUM MATERIAL CONDITION.

DIM	MILLIMETERS		INCHES	
	MIN	MAX	MIN	MAX
A	9.80	10.00	0.386	0.393
B	3.80	4.00	0.150	0.157
C	1.35	1.75	0.054	0.068
D	0.35	0.49	0.014	0.019
F	0.40	1.25	0.016	0.049
G	1.27 BSC		0.050 BSC	
J	0.19	0.25	0.008	0.009
K	0.10	0.25	0.004	0.009
M	0°	7°	0°	7°
P	5.80	6.20	0.229	0.244
R	0.25	0.50	0.010	0.019

SOLDERING FOOTPRINT*

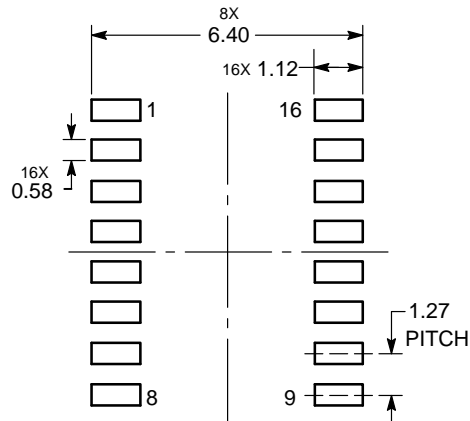

DIMENSIONS: MILLIMETERS

*For additional information on our Pb-Free strategy and soldering details, please download the ON Semiconductor Soldering and Mounting Techniques Reference Manual, SOLDERRM/D.

MC14049UB

PACKAGE DIMENSIONS

SOEIAJ-16
F SUFFIX
CASE 966
ISSUE A

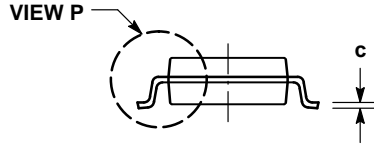
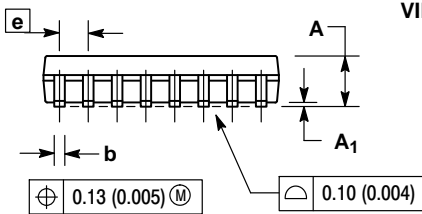
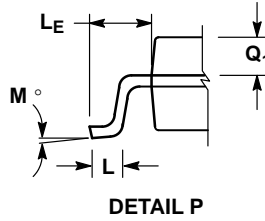
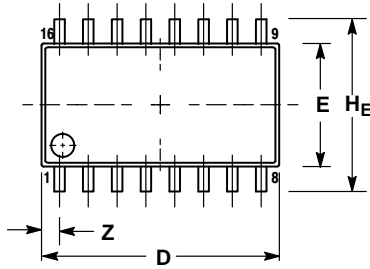

NOTES:

1. DIMENSIONING AND TOLERANCING PER ANSI Y14.5M, 1982.
2. CONTROLLING DIMENSION: MILLIMETER.
3. DIMENSIONS D AND E DO NOT INCLUDE MOLD FLASH OR PROTRUSIONS AND ARE MEASURED AT THE PARTING LINE. MOLD FLASH OR PROTRUSIONS SHALL NOT EXCEED 0.15 (0.006) PER SIDE.
4. TERMINAL NUMBERS ARE SHOWN FOR REFERENCE ONLY.
5. THE LEAD WIDTH DIMENSION (b) DOES NOT INCLUDE DAMBAR PROTRUSION. ALLOWABLE DAMBAR PROTRUSION SHALL BE 0.08 (0.003) TOTAL IN EXCESS OF THE LEAD WIDTH DIMENSION AT MAXIMUM MATERIAL CONDITION. DAMBAR CANNOT BE LOCATED ON THE LOWER RADIUS OR THE FOOT. MINIMUM SPACE BETWEEN PROTRUSIONS AND ADJACENT LEAD TO BE 0.46 (0.018).

DIM	MILLIMETERS		INCHES	
	MIN	MAX	MIN	MAX
A	---	2.05	---	0.081
A ₁	0.05	0.20	0.002	0.008
b	0.35	0.50	0.014	0.020
c	0.10	0.20	0.007	0.011
D	9.90	10.50	0.390	0.413
E	5.10	5.45	0.201	0.215
e	1.27 BSC		0.050 BSC	
H _E	7.40	8.20	0.291	0.323
L	0.50	0.85	0.020	0.033
L _E	1.10	1.50	0.043	0.059
M	0 °	10 °	0 °	10 °
Q ₁	0.70	0.90	0.028	0.035
Z	---	0.78	---	0.031

ON Semiconductor and are trademarks of Semiconductor Components Industries, LLC dba ON Semiconductor or its subsidiaries in the United States and/or other countries. ON Semiconductor owns the rights to a number of patents, trademarks, copyrights, trade secrets, and other intellectual property. A listing of ON Semiconductor's product/patent coverage may be accessed at www.onsemi.com/site/pdf/Patent-Marketing.pdf. ON Semiconductor reserves the right to make changes without further notice to any products herein. ON Semiconductor makes no warranty, representation or guarantee regarding the suitability of its products for any particular purpose, nor does ON Semiconductor assume any liability arising out of the application or use of any product or circuit, and specifically disclaims any and all liability, including without limitation special, consequential or incidental damages. Buyer is responsible for its products and applications using ON Semiconductor products, including compliance with all laws, regulations and safety requirements or standards, regardless of any support or applications information provided by ON Semiconductor. "Typical" parameters which may be provided in ON Semiconductor data sheets and/or specifications can and do vary in different applications and actual performance may vary over time. All operating parameters, including "Typicals" must be validated for each customer application by customer's technical experts. ON Semiconductor does not convey any license under its patent rights nor the rights of others. ON Semiconductor products are not designed, intended, or authorized for use as a critical component in life support systems or any FDA Class 3 medical devices or medical devices with a same or similar classification in a foreign jurisdiction or any devices intended for implantation in the human body. Should Buyer purchase or use ON Semiconductor products for any such unintended or unauthorized application, Buyer shall indemnify and hold ON Semiconductor and its officers, employees, subsidiaries, affiliates, and distributors harmless against all claims, costs, damages, and expenses, and reasonable attorney fees arising out of, directly or indirectly, any claim of personal injury or death associated with such unintended or unauthorized use, even if such claim alleges that ON Semiconductor was negligent regarding the design or manufacture of the part. ON Semiconductor is an Equal Opportunity/Affirmative Action Employer. This literature is subject to all applicable copyright laws and is not for resale in any manner.

PUBLICATION ORDERING INFORMATION

LITERATURE FULFILLMENT:

Literature Distribution Center for ON Semiconductor
19521 E. 32nd Pkwy, Aurora, Colorado 80011 USA
Phone: 303-675-2175 or 800-344-3860 Toll Free USA/Canada
Fax: 303-675-2176 or 800-344-3867 Toll Free USA/Canada
Email: orderlit@onsemi.com

N. American Technical Support: 800-282-9855 Toll Free
USA/Canada
Europe, Middle East and Africa Technical Support:
Phone: 421 33 790 2910
Japan Customer Focus Center
Phone: 81-3-5817-1050

ON Semiconductor Website: www.onsemi.com

Order Literature: <http://www.onsemi.com/orderlit>

For additional information, please contact your local Sales Representative

Looking for pricing, stock, or lifecycle information?

Click below to explore more details on WIN SOURCE:

 [View MC14049UBFELG on WIN SOURCE](#)

 [ON Semiconductor](#) Information

Optimize Your Supply Chain with WIN SOURCE Solutions

-  Global Sourcing Solution
-  Obsolete Management
-  Cost Control Management
-  Shortage Management
-  Alternative Solution
-  Excess Inventory Management