



**THE DATASHEET OF
MBR3045WTG**



MBR3045WTG

Switch Mode Power Rectifier

These state-of-the-art devices use the Schottky Barrier principle with a platinum barrier metal.

Features

- Dual Diode Construction; Terminals 1 and 3 may be Connected for Parallel Operation at Full Rating
- Guardring for Stress Protection
- Low Forward Voltage
- 175°C Operating Junction Temperature
- Popular TO-247 Package
- These Devices are Pb-Free, Halogen Free/BFR Free and are RoHS Compliant*

Mechanical Characteristics

- Case: Epoxy, Molded
- Weight: 4.3 Grams (Approximately)
- Finish: All External Surfaces Corrosion Resistant and Terminal Leads are Readily Solderable
- Lead Temperature for Soldering Purposes: 260°C Max. for 10 Seconds

MAXIMUM RATINGS

| Rating | Symbol | Max | Unit |
|--|---------------------------------|-------------|------------------|
| Peak Repetitive Reverse Voltage Working Peak Reverse Voltage DC Blocking Voltage | V_{RRM} V_{RWM} V_R | 45 | V |
| Average Rectified Forward Current (Rated V_R , $T_C = 105^\circ\text{C}$) Per Device Per Diode | $I_{F(AV)}$ | 30 15 | A |
| Peak Repetitive Forward Current, (Rated V_R , Square Wave, 20 kHz) Per Diode | I_{FRM} | 30 | A |
| Non-Repetitive Peak Surge Current (Surge Applied at Rated Load Conditions Halfwave, Single Phase, 60 Hz) | I_{FSM} | 200 | A |
| Peak Repetitive Reverse Current (2.0 μs , 1.0 kHz) Per Diode (See Figure 6) | I_{RRM} | 2.0 | A |
| Storage Temperature Range | T_{stg} | -65 to +175 | °C |
| Operating Junction Temperature (Note 1) | T_J | -65 to +175 | °C |
| Peak Surge Junction Temperature (Forward Current Applied) | $T_{J(pk)}$ | 175 | °C |
| Voltage Rate of Change (Rated V_R) | dv/dt | 10,000 | V/ μs |

Stresses exceeding those listed in the Maximum Ratings table may damage the device. If any of these limits are exceeded, device functionality should not be assumed, damage may occur and reliability may be affected.

1. The heat generated must be less than the thermal conductivity from Junction-to-Ambient: $dP_D/dT_J < 1/R_{\theta JA}$.

*For additional information on our Pb-Free strategy and soldering details, please download the ON Semiconductor Soldering and Mounting Techniques Reference Manual, SOLDERRM/D.



ON Semiconductor®

<http://onsemi.com>

**SCHOTTKY BARRIER
RECTIFIER
30 AMPERES, 45 VOLTS**

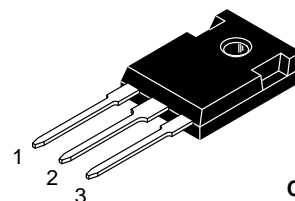
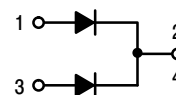

TO-247
CASE 340AL

MARKING DIAGRAM



A = Assembly Location
Y = Year
WW = Work Week
G = Pb-Free Package

ORDERING INFORMATION

| Device | Package | Shipping |
|------------|---------------------|---------------|
| MBR3045WTG | TO-247 (Pb-Free) | 30 Units/Rail |

MBR3045WTG

THERMAL CHARACTERISTICS (Per Diode)

| Rating | Symbol | Max | Unit |
|--------------------------------------|-----------------|-----|-----------------------------|
| Thermal Resistance, Junction-to-Case | $R_{\theta JC}$ | 1.4 | $^{\circ}\text{C}/\text{W}$ |
| Junction-to-Ambient | $R_{\theta JA}$ | 40 | $^{\circ}\text{C}/\text{W}$ |

ELECTRICAL CHARACTERISTICS (Per Diode)

| | | | |
|---|-------|---------------------|----|
| Instantaneous Forward Voltage (Note 2) ($i_F = 20$ Amps, $T_C = 125^{\circ}\text{C}$) ($i_F = 30$ Amps, $T_C = 125^{\circ}\text{C}$) ($i_F = 30$ Amps, $T_C = 25^{\circ}\text{C}$) | v_F | 0.6 0.72 0.76 | V |
| Instantaneous Reverse Current (Note 2) (Rated dc Voltage, $T_C = 125^{\circ}\text{C}$) (Rated dc Voltage, $T_C = 25^{\circ}\text{C}$) | i_R | 100 1.0 | mA |

Product parametric performance is indicated in the Electrical Characteristics for the listed test conditions, unless otherwise noted. Product performance may not be indicated by the Electrical Characteristics if operated under different conditions.

2. Pulse Test: Pulse Width = 300 μs , Duty Cycle $\leq 2.0\%$.

TYPICAL CHARACTERISTICS

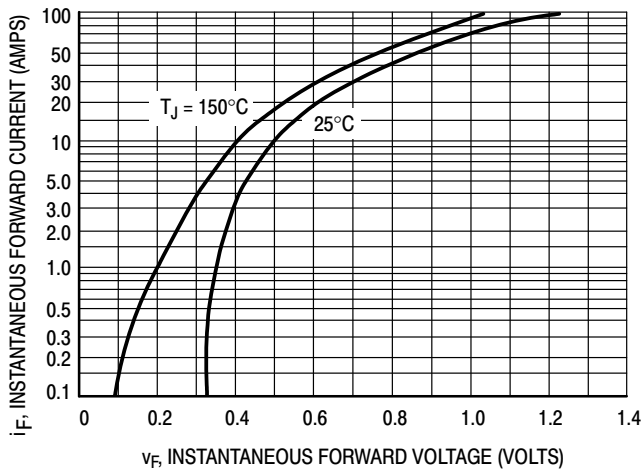

Figure 1. Typical Forward Voltage

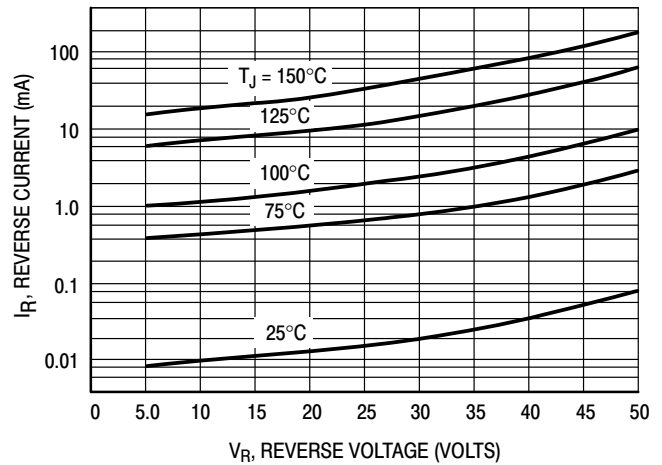

Figure 2. Typical Reverse Current

MBR3045WTG

TYPICAL CHARACTERISTICS

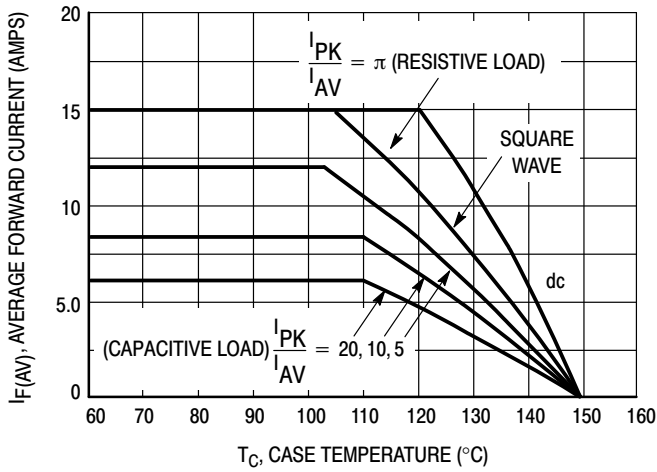

Figure 3. Current Derating (Per Leg)

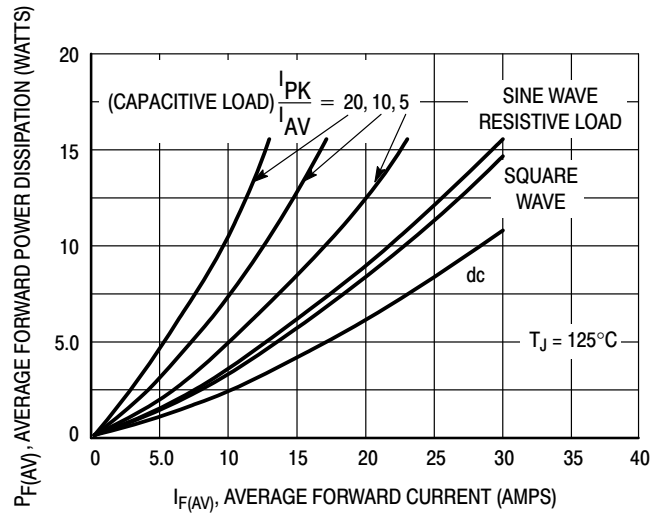

Figure 4. Forward Power Dissipation (Per Leg)

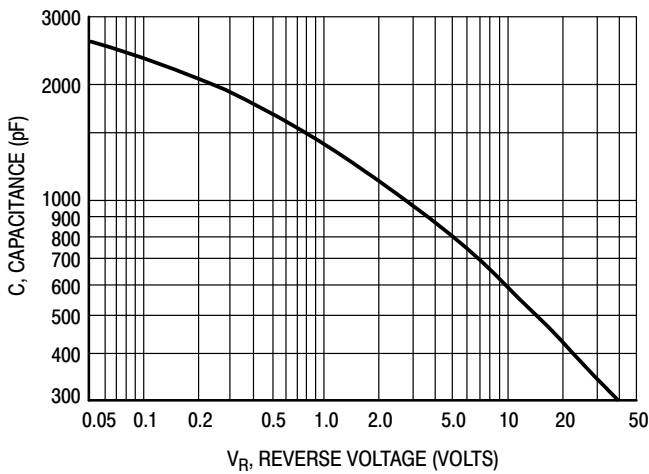

Figure 5. Capacitance

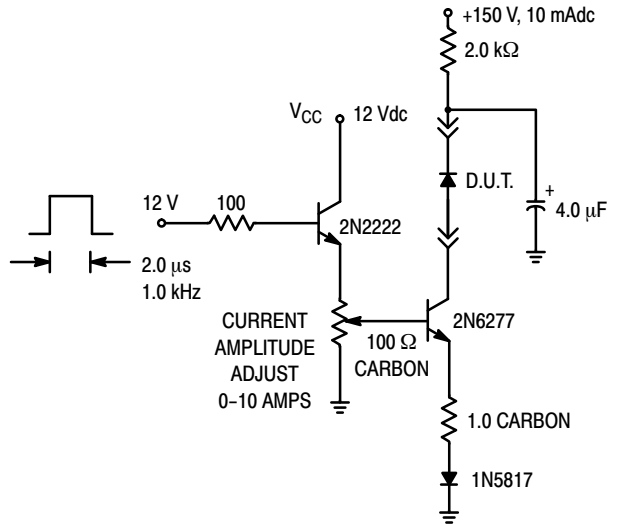
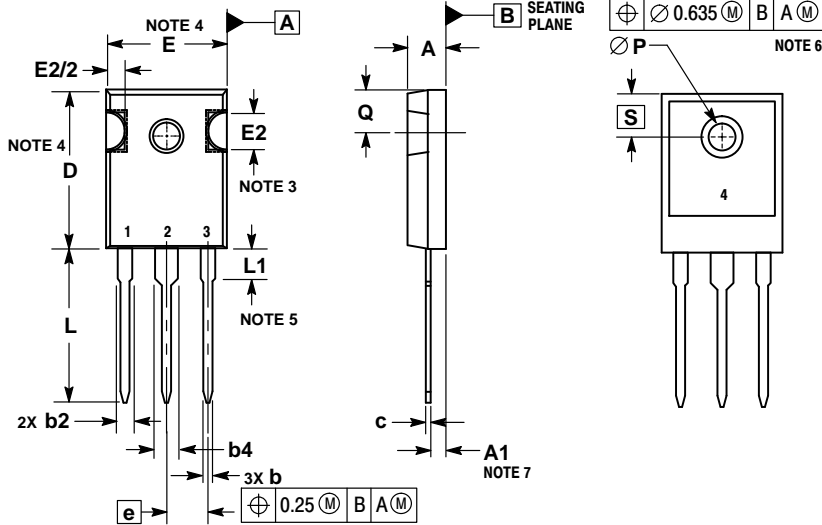

Figure 6. Test Circuit for Repetitive Reverse Current

MBR3045WTG

PACKAGE DIMENSIONS

TO-247 CASE 340AL ISSUE A



NOTES:

1. DIMENSIONING AND TOLERANCING PER ASME Y14.5M, 1994.
2. CONTROLLING DIMENSION: MILLIMETERS.
3. SLOT REQUIRED, NOTCH MAY BE ROUNDED.
4. DIMENSIONS D AND E DO NOT INCLUDE MOLD FLASH. MOLD FLASH SHALL NOT EXCEED 0.13 PER SIDE. THESE DIMENSIONS ARE MEASURED AT THE OUTERMOST EXTREME OF THE PLASTIC BODY.
5. LEAD FINISH IS UNCONTROLLED IN THE REGION DEFINED BY L1.
6. $\varnothing P$ SHALL HAVE A MAXIMUM DRAFT ANGLE OF 1.5° TO THE TOP OF THE PART WITH A MAXIMUM DIAMETER OF 3.91.
7. DIMENSION A1 TO BE MEASURED IN THE REGION DEFINED BY L1.

| DIM | MILLIMETERS | |
|-----|-------------|-------|
| | MIN | MAX |
| A | 4.70 | 5.30 |
| A1 | 2.20 | 2.60 |
| b | 1.00 | 1.40 |
| b2 | 1.65 | 2.35 |
| b4 | 2.60 | 3.40 |
| c | 0.40 | 0.80 |
| D | 20.30 | 21.40 |
| E | 15.50 | 16.25 |
| E2 | 4.32 | 5.49 |
| e | 5.45 BSC | |
| L | 19.80 | 20.80 |
| L1 | 3.50 | 4.50 |
| P | 3.55 | 3.65 |
| Q | 5.40 | 6.20 |
| S | 6.15 BSC | |

ON Semiconductor and the  are registered trademarks of Semiconductor Components Industries, LLC (SCILLC) or its subsidiaries in the United States and/or other countries. SCILLC owns the rights to a number of patents, trademarks, copyrights, trade secrets, and other intellectual property. A listing of SCILLC's product/patent coverage may be accessed at www.onsemi.com/site/pdf/Patent-Marking.pdf. SCILLC reserves the right to make changes without further notice to any products herein. SCILLC makes no warranty, representation or guarantee regarding the suitability of its products for any particular purpose, nor does SCILLC assume any liability arising out of the application or use of any product or circuit, and specifically disclaims any and all liability, including without limitation special, consequential or incidental damages. "Typical" parameters which may be provided in SCILLC data sheets and/or specifications can and do vary in different applications and actual performance may vary over time. All operating parameters, including "Typicals" must be validated for each customer application by customer's technical experts. SCILLC does not convey any license under its patent rights nor the rights of others. SCILLC products are not designed, intended, or authorized for use as components in systems intended for surgical implant into the body, or other applications intended to support or sustain life, or for any other application in which the failure of the SCILLC product could create a situation where personal injury or death may occur. Should Buyer purchase or use SCILLC products for any such unintended or unauthorized application, Buyer shall indemnify and hold SCILLC and its officers, employees, subsidiaries, affiliates, and distributors harmless against all claims, costs, damages, and expenses, and reasonable attorney fees arising out of, directly or indirectly, any claim of personal injury or death associated with such unintended or unauthorized use, even if such claim alleges that SCILLC was negligent regarding the design or manufacture of the part. SCILLC is an Equal Opportunity/Affirmative Action Employer. This literature is subject to all applicable copyright laws and is not for resale in any manner.

PUBLICATION ORDERING INFORMATION

LITERATURE FULFILLMENT:

Literature Distribution Center for ON Semiconductor
P.O. Box 5163, Denver, Colorado 80217 USA
Phone: 303-675-2175 or 800-344-3860 Toll Free USA/Canada
Fax: 303-675-2176 or 800-344-3867 Toll Free USA/Canada
Email: orderlit@onsemi.com

N. American Technical Support: 800-282-9855 Toll Free
USA/Canada
Europe, Middle East and Africa Technical Support:
Phone: 421 33 790 2910
Japan Customer Focus Center
Phone: 81-3-5817-1050

ON Semiconductor Website: www.onsemi.com

Order Literature: <http://www.onsemi.com/orderlit>

For additional information, please contact your local Sales Representative

Looking for pricing, stock, or lifecycle information?

Click below to explore more details on WIN SOURCE:

 [View MBR3045WTG on WIN SOURCE](#)

 [ON Semiconductor](#) Information

Optimize Your Supply Chain with WIN SOURCE Solutions

-  Global Sourcing Solution
-  Obsolete Management
-  Cost Control Management
-  Shortage Management
-  Alternative Solution
-  Excess Inventory Management