



**THE DATASHEET OF
MB96F313RSBPMC-GSE2**



F²MC-16FX 16-bit Proprietary Microcontroller

CY96310 series is based on Cypress advanced 16FX architecture (16-bit with instruction pipeline for RISC-like performance). The CPU uses the same instruction set as the established 16LX series - thus allowing for easy migration of 16LX Software to the new 16FX products. 16FX improvements compared to the previous generation include significantly improved performance - even at the same operation frequency, reduced power consumption and faster start-up time.

For highest processing speed at optimized power consumption an internal PLL can be selected to supply the CPU with up to 56MHz operation frequency from an external 4MHz resonator. The result is a minimum instruction cycle time of 17.8ns going together with excellent EMI behavior. An on-chip clock modulation circuit significantly reduces emission peaks in the frequency spectrum. The emitted power is minimized by the on-chip voltage regulator that reduces the internal CPU voltage. A flexible clock tree allows to select suitable operation frequencies for peripheral resources independent of the CPU speed.

Features

Technology

- 0.18µm CMOS

CPU

- F²MC-16FX CPU
- Up to 56 MHz internal, 17.8 ns instruction cycle time
- Optimized instruction set for controller applications (bit, byte, word and long-word data types; 23 different addressing modes; barrel shift; variety of pointers)
- 8-byte instruction execution queue
- Signed multiply (16-bit × 16-bit) and divide (32-bit/16-bit) instructions available

System clock

- On-chip PLL clock multiplier (x1 - x25, x1 when PLL stop)
- 3 MHz - 16 MHz external crystal oscillator clock (maximum frequency when using ceramic resonator depends on Q-factor).
- Up to 56 MHz external clock
- 32-100 kHz subsystem quartz clock
- 100kHz/2MHz internal RC clock for quick and safe startup, oscillator stop detection, watchdog
- Clock source selectable from main- and subclock oscillator (part number suffix "W") and on-chip RC oscillator, independently for CPU and 2 clock domains of peripherals.
- Low Power Consumption - 13 operating modes: (different Run, Sleep, Timer modes, Stop mode)
- Clock modulator

On-chip voltage regulator

- Internal voltage regulator supports reduced internal MCU voltage, offering low EMI and low power consumption figures

Low voltage reset

- Reset is generated when supply voltage is below minimum.

Code Security

- Protects ROM content from unintended read-out

Memory Patch Function

- Replaces ROM content
- Can also be used to implement embedded debug support

DMA

- Automatic transfer function independent of CPU, can be assigned freely to resources

Interrupts

- Fast Interrupt processing
- 8 programmable priority levels
- Non-Maskable Interrupt (NMI)

Timers

- Three independent clock timers (23-bit RC clock timer, 23-bit Main clock timer, 17-bit Sub clock timer)
- Watchdog Timer

CAN

- Supports CAN protocol version 2.0 part A and B
- ISO16845 certified
- Bit rates up to 1 Mbit/s
- 32 message objects
- Each message object has its own identifier mask
- Programmable FIFO mode (concatenation of message objects)
- Maskable interrupt
- Disabled Automatic Retransmission mode for Time Triggered CAN applications
- Programmable loop-back mode for self-test operation

USART

- Full duplex USARTs (SCI/LIN)
- Wide range of baud rate settings using a dedicated reload timer
- Special synchronous options for adapting to different synchronous serial protocols
- LIN functionality working either as master or slave LIN device

A/D converter

- SAR-type
- 10-bit resolution
- Signals interrupt on conversion end, single conversion mode, continuous conversion mode, stop conversion mode, activation by software, external trigger or reload timer

Reload Timers

- 16-bit wide
- Prescaler with $1/2^1$, $1/2^2$, $1/2^3$, $1/2^4$, $1/2^5$, $1/2^6$ of peripheral clock frequency
- Event count function

Free Running Timers

- Signals an interrupt on overflow, supports timer clear upon match with Output Compare (0, 4), Prescaler with 1, $1/2^1$, $1/2^2$, $1/2^3$, $1/2^4$, $1/2^5$, $1/2^6$, $1/2^7$, $1/2^8$ of peripheral clock frequency

Input Capture Units

- 16-bit wide
- Signals an interrupt upon external event
- Rising edge, falling edge or rising & falling edge sensitive

Output Compare Units

- 16-bit wide
- Signals an interrupt when a match with 16-bit I/O Timer occurs
- A pair of compare registers can be used to generate an output signal.

Programmable Pulse Generator

- 16-bit down counter, cycle and duty setting registers
- Interrupt at trigger, counter borrow and/or duty match
- PWM operation and one-shot operation
- Internal prescaler allows 1, 1/4, 1/16, 1/64 of peripheral clock as counter clock and Reload timer underflow as clock input
- Can be triggered by software or reload timer

Real Time Clock

- Can be clocked either from sub oscillator (devices with part number suffix "W"), main oscillator or from the RC oscillator
- Facility to correct oscillation deviation of Sub clock or RC oscillator clock (clock calibration)
- Read/write accessible second/minute/hour registers
- Can signal interrupts every half second/second/minute/hour/day
- Internal clock divider and prescaler provide exact 1s clock

External Interrupts

- Edge sensitive or level sensitive
- Interrupt mask and pending bit per channel
- Each available CAN channel RX has an external interrupt for wake-up
- Selected USART channels SIN have an external interrupt for wake-up

Non Maskable Interrupt

- Disabled after reset
- Once enabled, can not be disabled other than by reset.
- Level high or level low sensitive
- Pin shared with external interrupt 0.

I/O Ports

- Virtually all external pins can be used as general purpose I/O
- All push-pull outputs
- Bit-wise programmable as input/output or peripheral signal
- Bit-wise programmable input enable
- Bit-wise programmable input levels: Automotive / CMOS-Schmitt trigger / TTL
- Bit-wise programmable pull-up resistor
- Bit-wise programmable output driving strength for EMI optimization

Packages

- 48-pin plastic LQFP M26

Flash Memory

- Supports automatic programming, Embedded Algorithm
- Write/Erase/Erase-Suspend/Resume commands
- A flag indicating completion of the algorithm
- Number of erase cycles: 10,000 times
- Data retention time: 20 years
- Erase can be performed on each sector individually
- Sector protection
- Flash Security feature to protect the content of the Flash
- Low voltage detection during Flash erase

Contents

Product Lineup	5	Pin handling when not using the A/D converter	43
Block Diagram	6	Notes on Power-on	43
Pin Assignments	7	Stabilization of power supply voltage	44
Pin Function Description	8	Serial communication	44
Pin Circuit Type	10	Electrical Characteristics	45
I/O Circuit Type	11	Absolute Maximum Ratings	45
Memory Map	13	Recommended Operating Conditions	47
RAMSTART Addresses	14	DC characteristics	48
User ROM Memory Map for Flash Devices	15	AC Characteristics	55
Serial Programming Communication Interface	16	Analog Digital Converter	63
I/O Map	17	Low Voltage Detector characteristics	67
Interrupt Vector Table	39	FLASH memory program/erase characteristics	69
Handling Devices	42	Example Characteristics	70
Latch-up prevention	42	Temperature dependency of	
Unused pins handling	42	power supply currents	70
External clock usage	42	Frequency dependency of	
Unused sub clock signal	43	power supply currents in PLL Run mode	75
Notes on PLL clock mode operation	43	Package Dimension CY96(F)31x LQFP48	76
Power supply pins (VCC/VSS)	43	Ordering Information	77
Crystal oscillator and ceramic resonator circuit	43	Revision History	78
Turn on sequence of power supply to		Major Changes	79
A/D converter and analog inputs	43	Document History	81

1. Product Lineup

Features		CY96V300C	CY96(F)31x
Product type		Evaluation sample	Flash product: CY96F31x Mask ROM product: CY9631x
Product options			
YS		NA	Low voltage reset persistently on / Single clock devices
RS			Low voltage reset can be disabled / Single clock devices
YW			Low voltage reset persistently on / Dual clock devices
RW			Low voltage reset can be disabled / Dual clock devices
AS			No CAN / Low voltage reset can be disabled / Single clock devices
AW			No CAN / Low voltage reset can be disabled / Dual clock devices
Flash/ROM	RAM		
96KB	8KB	ROM/Flash memory emulation by external RAM, 92KB internal RAM	CY96F313Y, CY96F313R, CY96F313A
160KB	8KB		CY96F315Y, CY96F315R, CY96F315A
Package		BGA416	LQA048
DMA		16 channels	4 channels
USART		10 channels	3 channels
A/D Converter		40 channels	12 channels
A/D Converter Reference Voltage switch		yes	No
16-bit Reload Timer		6 channels + 1 channel (for PPG)	4 channels + 1 channel (for PPG)
16-bit Free-Running Timer		4 channels	4 channels (without external clock input pin)
16-bit Output Compare		12 channels	2 channels
16-bit Input Capture		12 channels	4 channels (plus 3 channels for LIN USART)
16-bit Programmable Pulse Generator		20 channels	14 channels
CAN Interface		5 channels	1 channel
External Interrupts		16 channels	11 channels
Non-Maskable Interrupt			1 channel
Real Time Clock			1
I/O Ports		136	34 for part number with suffix "W", 36 for part number with suffix "S"
Clock output function			2 channels
Low voltage reset			Yes
On-chip RC-oscillator			Yes

2. Block Diagram

Block Diagram of CY96(F)31x

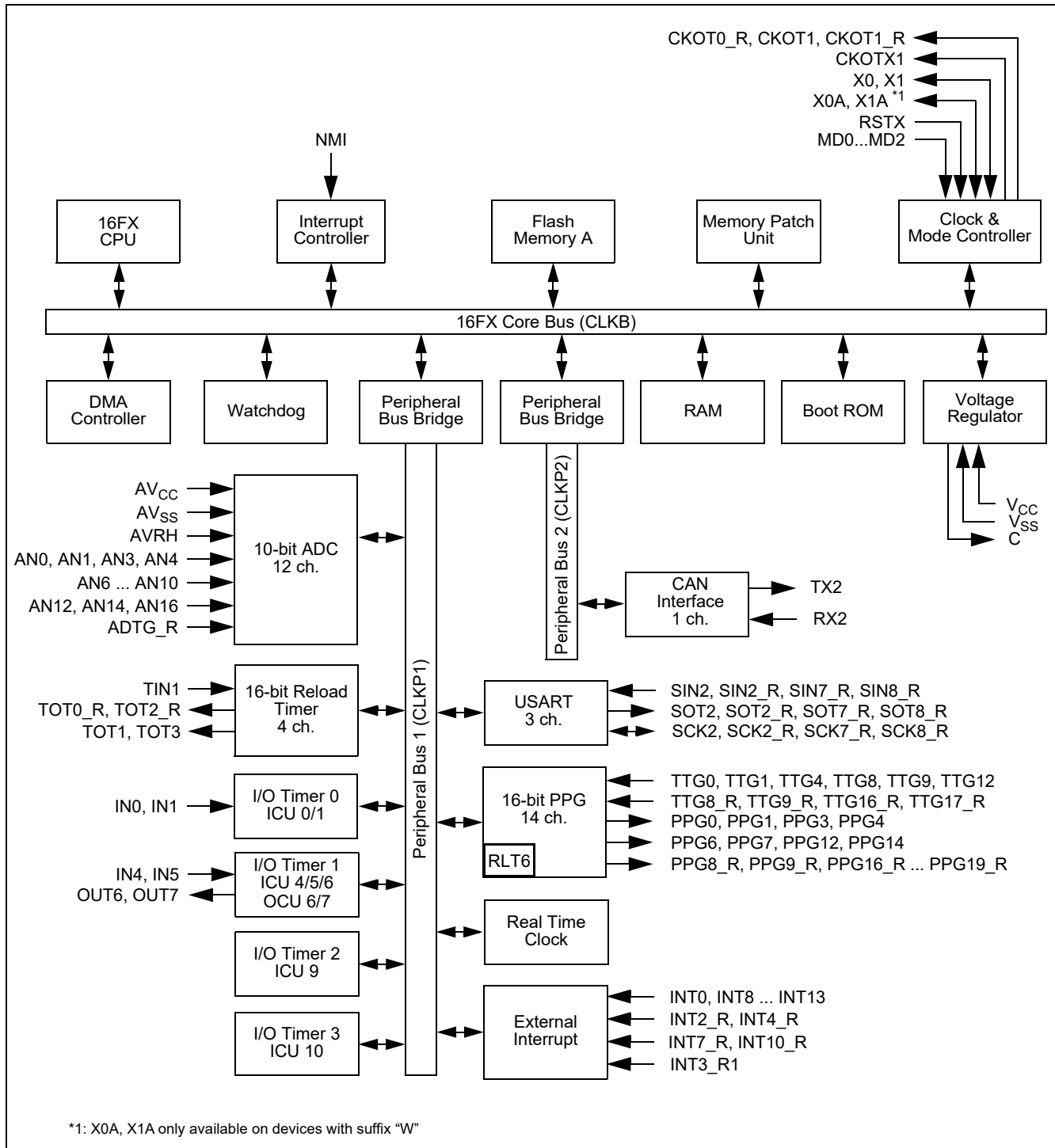

3. Pin Assignments

Pin assignment of CY96(F)31x

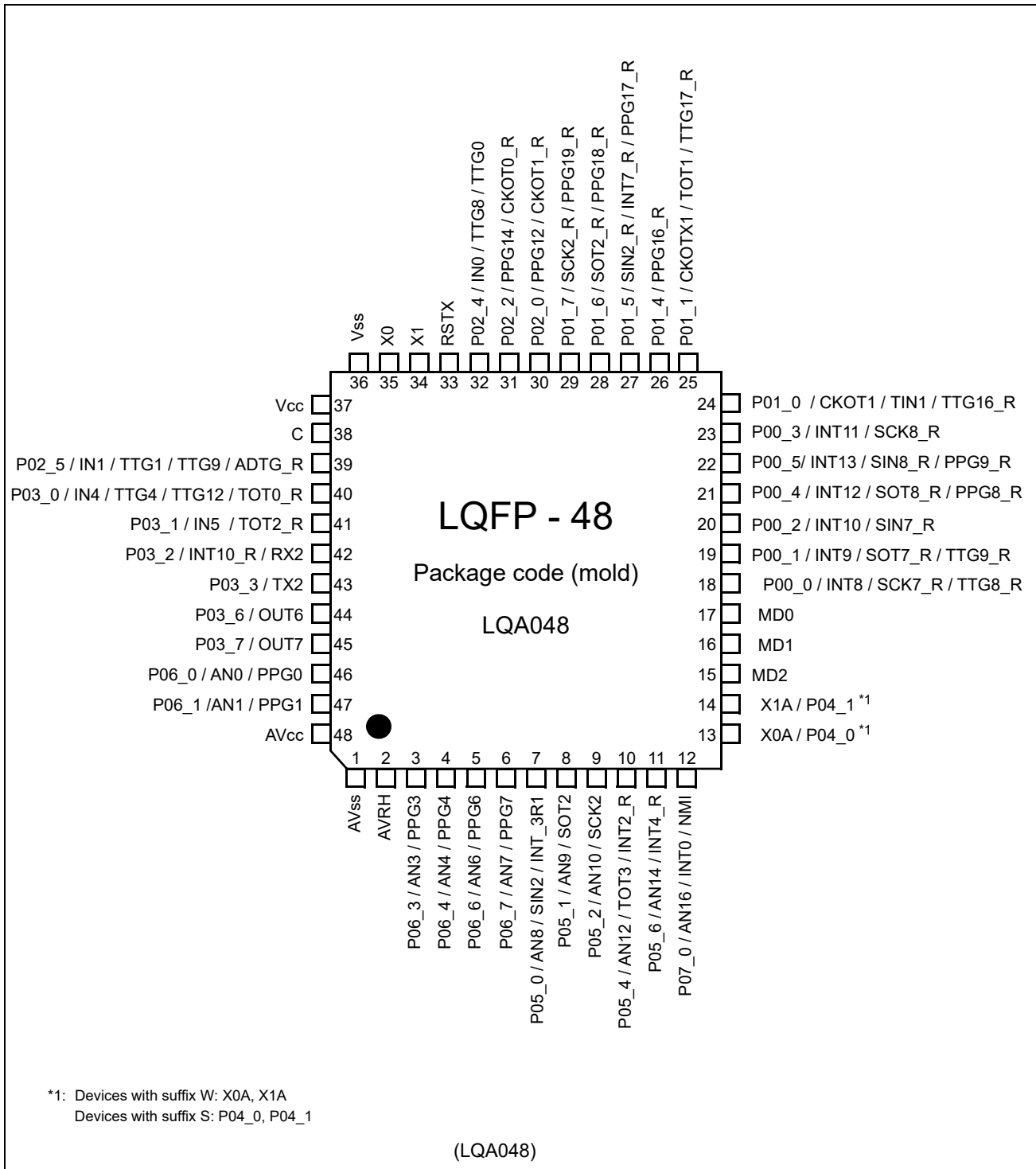

4. Pin Function Description

Pin Function description (1 of 2)

Pin name	Feature	Description
ADTG_R	ADC	Relocated A/D converter trigger input
ANn	ADC	A/D converter channel n input
AV _{CC}	Supply	Analog circuits power supply
AVRH	ADC	A/D converter high reference voltage input
AV _{SS}	Supply	Analog circuits power supply
C	Voltage regulator	Internally regulated power supply stabilization capacitor pin
CKOTn	Clock output function	Clock Output function n output
CKOTn_R	Clock output function	Relocated Clock Output function n output
CKOTXn	Clock output function	Clock Output function n inverted output
INn	ICU	Input Capture Unit n input
INTn	External Interrupt	External Interrupt n input
INTn_R	External Interrupt	Relocated External Interrupt n input
MDn	Core	Input pins for specifying the operating mode.
NMI	External Interrupt	Non-Maskable Interrupt input
OUTn	OCU	Output Compare Unit n waveform output
Pxx_n	GPIO	General purpose IO
PPGn	PPG	Programmable Pulse Generator n output
PPGn_R	PPG	Relocated Programmable Pulse Generator n output
RSTX	Core	Reset input
RXn	CAN	CAN interface n RX input
SCKn	USART	USART n serial clock input/output
SCKn_R	USART	Relocated USART n serial clock input/output
SINn	USART	USART n serial data input
SINn_R	USART	Relocated USART n serial data input
SOTn	USART	USART n serial data output
SOTn_R	USART	Relocated USART n serial data output
TINn	Reload Timer	Reload Timer n event input
TINn_R	Reload Timer	Relocated Reload Timer n event input
TOTn	Reload Timer	Reload Timer n output
TOTn_R	Reload Timer	Relocated Reload Timer n output

Pin Function description (2 of 2)

Pin name	Feature	Description
TTGn	PPG	Programmable Pulse Generator n trigger input
TTGn_R	PPG	Relocated Programmable Pulse Generator n trigger input
TXn	CAN	CAN interface n TX output
V _{CC}	Supply	Power supply
V _{SS}	Supply	Power supply
X0	Clock	Oscillator input
X0A	Clock	Subclock Oscillator input (only for devices with suffix "W")
X1	Clock	Oscillator output
X1A	Clock	Subclock Oscillator output (only for devices with suffix "W")

5. Pin Circuit Type

Pin circuit types

LQA048	
Pin no.	Circuit type ^{*1}
1	Supply
2	G
3 to 12	I
13, 14	B ^{*2}
13, 14	H ^{*3}
15 to 17	C
18 to 32	H
33	E
34, 35	A
36, 37	Supply
38	F
39 to 45	H
46, 47	I
48	Supply

*1: Please refer to "6. I/O Circuit Type" for details on the I/O circuit types

*2: Devices with suffix "W"

*3: Devices without suffix "W"

6. I/O Circuit Type

Type	Circuit	Remarks
A		<p>High-speed oscillation circuit:</p> <ul style="list-style-type: none"> • Programmable between oscillation mode (external crystal or resonator connected to X0/X1 pins) and Fast external Clock Input (FCI) mode (external clock connected to X0 pin) • Programmable feedback resistor = approx. $2 * 0.5 \text{ M}\Omega$. Feedback resistor is grounded in the center when the oscillator is disabled or in FCI mode
B		<p>Low-speed oscillation circuit:</p> <ul style="list-style-type: none"> • Programmable feedback resistor = approx. $2 * 5 \text{ M}\Omega$. Feedback resistor is grounded in the center when the oscillator is disabled
C		<ul style="list-style-type: none"> • Mask ROM and EVA device: CMOS Hysteresis input pin • Flash device: CMOS input pin
E		<ul style="list-style-type: none"> • CMOS Hysteresis input pin • Pull-up resistor value: approx. $50 \text{ k}\Omega$

Type	Circuit	Remarks
F		<ul style="list-style-type: none"> • Power supply input protection circuit
G		<ul style="list-style-type: none"> • A/D converter ref+ (AVRH) power supply input pin with protection circuit • Flash devices do not have a protection circuit against VCC for pin AVRH
H		<ul style="list-style-type: none"> • CMOS level output (programmable $I_{OL} = 5\text{mA}$, $I_{OH} = -5\text{mA}$ and $I_{OL} = 2\text{mA}$, $I_{OH} = -2\text{mA}$) • CMOS hysteresis input with input shutdown function • Automotive input with input shutdown function • Programmable pull-up resistor: $50\text{k}\Omega$ approx.
I		<ul style="list-style-type: none"> • CMOS level output (programmable $I_{OL} = 5\text{mA}$, $I_{OH} = -5\text{mA}$ and $I_{OL} = 2\text{mA}$, $I_{OH} = -2\text{mA}$) • CMOS hysteresis input with input shutdown function • Automotive input with input shutdown function • Programmable pull-up resistor: $50\text{k}\Omega$ approx. • Analog input

7. Memory Map

	CY96V300C		CY96(F)31x
FF:FFF _H	Emulation ROM		USER ROM / Reserved ^{*4}
DE:000 _H			
	External Bus		Reserved
10:000 _H			
0F:E00 _H	Boot-ROM		Boot-ROM
	Reserved		
0E:000 _H			
	External RAM		Reserved
02:000 _H			
	Internal RAM bank 1		
01:000 _H			
	ROM/RAM MIRROR		ROM/RAM MIRROR
00:800 _H			
	Internal RAM bank 0	RAMSTART0 ^{*2}	Internal RAM bank 0
			Reserved
RAM-START0 ^{*3}			
00:0C00 _H	External Bus		
	Peripherals		Peripherals
00:0380 _H			
	GPR ^{*1}		GPR ^{*1}
00:0180 _H			
	DMA		DMA
00:0100 _H			
	External Bus		Reserved
00:00F0 _H			
	Peripheral		Peripheral
00:0000 _H			

*1: Unused GPR banks can be used as RAM area
 *2: For RAMSTART0 addresses, please refer to the table on the next page.
 *3: For EVA device, RAMSTART0 depends on the configuration of the emulated device.
 *4: For details about USER ROM area, see the ■ User ROM Memory Map for Flash Devices on the following pages.
 The DMA area is only available if the device contains the corresponding resource.
 The available RAM and ROM area depends on the device.

8. RAMSTART Addresses

Devices	RAM size	RAMSTART0
CY96F313/F315	8KByte	00:6240 _H

9. User ROM Memory Map for Flash Devices

		CY96F313	CY96F315																													
Alternative mode CPU address	Flash memory mode address	Flash size 96kByte	Flash size 160kByte																													
FF:FFF _H FF:000 _H	3F:FFF _H 3F:000 _H	S39 - 64K	S39 - 64K	Flash A																												
FE:FFF _H FE:000 _H	3E:FFF _H 3E:000 _H	Reserved	S38 - 64K																													
FD:FFF _H FD:000 _H	3D:FFF _H 3D:000 _H		Reserved	Reserved																												
FC:FFF _H FC:000 _H	3C:FFF _H 3C:000 _H				Reserved	Reserved																										
FB:FFF _H FB:000 _H	3B:FFF _H 3B:000 _H						Reserved	Reserved																								
FA:FFF _H FA:000 _H	3A:FFF _H 3A:000 _H								Reserved	Reserved																						
F9:FFF _H F9:000 _H	39:FFF _H 39:000 _H										Reserved	Reserved																				
F8:FFF _H F8:000 _H	38:FFF _H 38:000 _H												Reserved	Reserved																		
F7:FFF _H F7:000 _H	37:FFF _H 37:000 _H														Reserved	Reserved																
F6:FFF _H F6:000 _H	36:FFF _H 36:000 _H																Reserved	Reserved														
F5:FFF _H F5:000 _H	35:FFF _H 35:000 _H																		Reserved	Reserved												
F4:FFF _H F4:000 _H	34:FFF _H 34:000 _H																				Reserved	Reserved										
F3:FFF _H F3:000 _H	33:FFF _H 33:000 _H																						Reserved	Reserved								
F2:FFF _H F2:000 _H	32:FFF _H 32:000 _H																								Reserved	Reserved						
F1:FFF _H F1:000 _H	31:FFF _H 31:000 _H																										Reserved	Reserved				
F0:FFF _H F0:000 _H	30:FFF _H 30:000 _H																												Reserved	Reserved		
E0:FFF _H																															Reserved	Reserved
DF:FFF _H		Reserved																														
DF:800 _H			Reserved	Reserved																												
DF:7FF _H DF:600 _H	1F:7FF _H 1F:600 _H				SA3 - 8K	SA3 - 8K																										
DF:5FF _H DF:400 _H	1F:5FF _H 1F:400 _H				SA2 - 8K	SA2 - 8K																										
DF:3FF _H DF:200 _H	1F:3FF _H 1F:200 _H				SA1 - 8K	SA1 - 8K																										
DF:1FF _H DF:000 _H	1F:1FF _H 1F:000 _H				SA0 - 8K *1	SA0 - 8K *1																										
DE:FFF _H					Reserved	Reserved																										
DE:000 _H					Reserved	Reserved																										

*1: Sector SA0 contains the ROM Configuration Block RCBA at CPU address DF:000_H - DF:007_H

10. Serial Programming Communication Interface

USART pins for Flash serial programming (MD[2:0] = 010)

CY96F31x		
Pin number	USART Number	Normal function
LQFP-48		
7	USART2	SIN2
8		SOT2
9		SCK2
20	USART7	SIN7_R
19		SOT7_R
18		SCK7_R
22	USART8	SIN8_R
21		SOT8_R
23		SCK8_R

Note: If a Flash programmer and its software needs to use a handshaking pin, Cypress suggests to the tool vendor to support at least port P00_1 on pin 19.

If handshaking is used by the tool but P00_1 is not available in customer's application, Cypress suggests to the customer to check the tool manual or to contact the tool vendor for alternative handshaking pins.

11. I/O Map

I/O map CY96(F)315x (Sheet 1 of 22)

Address	Register	Abbreviation 8-bit access	Abbreviation 16-bit access	Access
000000 _H	I/O Port P00 - Port Data Register	PDR00		R/W
000001 _H	I/O Port P01 - Port Data Register	PDR01		R/W
000002 _H	I/O Port P02 - Port Data Register	PDR02		R/W
000003 _H	I/O Port P03 - Port Data Register	PDR03		R/W
000004 _H	Reserved			-
000005 _H	I/O Port P05 - Port Data Register	PDR05		R/W
000006 _H	I/O Port P06 - Port Data Register	PDR06		R/W
000007 _H	I/O Port P07 - Port Data Register	PDR07		R/W
000008 _H - 000017 _H	Reserved			-
000018 _H	ADC0 - Control Status register Low	ADCSL	ADCS	R/W
000019 _H	ADC0 - Control Status register High	ADCSH		R/W
00001A _H	ADC0 - Data Register Low	ADCRL	ADCR	R
00001B _H	ADC0 - Data Register High	ADCRH		R
00001C _H	ADC0 - Setting Register		ADSR	R/W
00001D _H	ADC0 - Setting Register			R/W
00001E _H	ADC0 - Extended Configuration Register	ADECR		R/W
00001F _H	Reserved			-
000020 _H	FRT0 - Data register of free-running timer		TCDT0	R/W
000021 _H	FRT0 - Data register of free-running timer			R/W
000022 _H	FRT0 - Control status register of free-running timer Low	TCCSL0	TCCS0	R/W
000023 _H	FRT0 - Control status register of free-running timer High	TCCSH0		R/W
000024 _H	FRT1 - Data register of free-running timer		TCDT1	R/W
000025 _H	FRT1 - Data register of free-running timer			R/W
000026 _H	FRT1 - Control status register of free-running timer Low	TCCSL1	TCCS1	R/W
000027 _H	FRT1 - Control status register of free-running timer High	TCCSH1		R/W
000028 _H - 000039 _H	Reserved			-
00003A _H	OCU6 - Output Compare Control Status	OCS6		R/W
00003B _H	OCU7 - Output Compare Control Status	OCS7		R/W

I/O map CY96(F)315x (Sheet 2 of 22)

Address	Register	Abbreviation 8-bit access	Abbreviation 16-bit access	Access
00003C _H	OCU6 - Compare Register		OCCP6	R/W
00003D _H	OCU6 - Compare Register			R/W
00003E _H	OCU7 - Compare Register		OCCP7	R/W
00003F _H	OCU7 - Compare Register			R/W
000040 _H	ICU0/ICU1 - Control Status Register	ICS01		R/W
000041 _H	ICU0/ICU1 - Edge register	ICE01		R/W
000042 _H	ICU0 - Capture Register Low	IPCPL0	IPCP0	R
000043 _H	ICU0 - Capture Register High	IPCPL0		R
000044 _H	ICU1 - Capture Register Low	IPCPL1	IPCP1	R
000045 _H	ICU1 - Capture Register High	IPCPL1		R
000046 _H - 00004B _H	Reserved			-
00004C _H	ICU4/ICU5 - Control Status Register	ICS45		R/W
00004D _H	ICU4/ICU5 - Edge register	ICE45		R/W
00004E _H	ICU4 - Capture Register Low	IPCPL4	IPCP4	R
00004F _H	ICU4 - Capture Register High	IPCPL4		R
000050 _H	ICU5 - Capture Register Low	IPCPL5	IPCP5	R
000051 _H	ICU5 - Capture Register High	IPCPL5		R
000052 _H	ICU6/ICU7 - Control Status Register	ICS67		R/W
000053 _H	ICU6/ICU7 - Edge register	ICE67		R/W
000054 _H	ICU6 - Capture Register Low	IPCPL6	IPCP6	R
000055 _H	ICU6 - Capture Register High	IPCPL6		R
000056 _H	ICU7 - Capture Register Low	IPCPL7	IPCP7	R
000057 _H	ICU7 - Capture Register High	IPCPL7		R
000058 _H	EXTINT0 - External Interrupt Enable Register	ENIR0		R/W
000059 _H	EXTINT0 - External Interrupt Interrupt request Register	EIRR0		R/W
00005A _H	EXTINT0 - External Interrupt Level Select Low	ELVRL0	ELVR0	R/W
00005B _H	EXTINT0 - External Interrupt Level Select High	ELVRH0		R/W
00005C _H	EXTINT1 - External Interrupt Enable Register	ENIR1		R/W
00005D _H	EXTINT1 - External Interrupt Interrupt request Register	EIRR1		R/W
00005E _H	EXTINT1 - External Interrupt Level Select Low	ELVRL1	ELVR1	R/W

I/O map CY96(F)315x (Sheet 3 of 22)

Address	Register	Abbreviation 8-bit access	Abbreviation 16-bit access	Access
00005F _H	EXTINT1 - External Interrupt Level Select High	ELVRH1		R/W
000060 _H	RLT0 - Timer Control Status Register Low	TMCSRL0	TMCSR0	R/W
000061 _H	RLT0 - Timer Control Status Register High	TMCSRH0		R/W
000062 _H	RLT0 - Reload Register - for writing		TMRLR0	W
000062 _H	RLT0 - Reload Register - for reading		TMR0	R
000063 _H	RLT0 - Reload Register - for writing			W
000063 _H	RLT0 - Reload Register - for reading			R
000064 _H	RLT1 - Timer Control Status Register Low	TMCSRL1	TMCSR1	R/W
000065 _H	RLT1 - Timer Control Status Register High	TMCSRH1		R/W
000066 _H	RLT1 - Reload Register - for writing		TMRLR1	W
000066 _H	RLT1 - Reload Register - for reading		TMR1	R
000067 _H	RLT1 - Reload Register - for writing			W
000067 _H	RLT1 - Reload Register - for reading			R
000068 _H	RLT2 - Timer Control Status Register Low	TMCSRL2	TMCSR2	R/W
000069 _H	RLT2 - Timer Control Status Register High	TMCSRH2		R/W
00006A _H	RLT2 - Reload Register - for writing		TMRLR2	W
00006A _H	RLT2 - Reload Register - for reading		TMR2	R
00006B _H	RLT2 - Reload Register - for writing			W
00006B _H	RLT2 - Reload Register - for reading			R
00006C _H	RLT3 - Timer Control Status Register Low	TMCSRL3	TMCSR3	R/W
00006D _H	RLT3 - Timer Control Status Register High	TMCSRH3		R/W
00006E _H	RLT3 - Reload Register - for writing		TMRLR3	W
00006E _H	RLT3 - Reload Register - for reading		TMR3	R
00006F _H	RLT3 - Reload Register - for writing			W
00006F _H	RLT3 - Reload Register - for reading			R
000070 _H	RLT6 - Timer Control Status Register Low (dedic. RLT for PPG)	TMCSRL6	TMCSR6	R/W
000071 _H	RLT6 - Timer Control Status Register High (dedic. RLT for PPG)	TMCSRH6		R/W
000072 _H	RLT6 - Reload Register (dedic. RLT for PPG) - for writing		TMRLR6	W
000072 _H	RLT6 - Reload Register (dedic. RLT for PPG) - for reading		TMR6	R

I/O map CY96(F)315x (Sheet 4 of 22)

Address	Register	Abbreviation 8-bit access	Abbreviation 16-bit access	Access
000073 _H	RLT6 - Reload Register (dedic. RLT for PPG) - for writing			W
000073 _H	RLT6 - Reload Register (dedic. RLT for PPG) - for reading			R
000074 _H	PPG3-PPG0 - General Control register 1 Low	GCN1L0	GCN10	R/W
000075 _H	PPG3-PPG0 - General Control register 1 High	GCN1H0		R/W
000076 _H	PPG3-PPG0 - General Control register 2 Low	GCN2L0	GCN20	R/W
000077 _H	PPG3-PPG0 - General Control register 2 High	GCN2H0		R/W
000078 _H	PPG0 - Timer register		PTMR0	R
000079 _H	PPG0 - Timer register			R
00007A _H	PPG0 - Period setting register		PCSR0	W
00007B _H	PPG0 - Period setting register			W
00007C _H	PPG0 - Duty cycle register		PDUT0	W
00007D _H	PPG0 - Duty cycle register			W
00007E _H	PPG0 - Control status register Low	PCNL0	PCN0	R/W
00007F _H	PPG0 - Control status register High	PCNH0		R/W
000080 _H	PPG1 - Timer register		PTMR1	R
000081 _H	PPG1 - Timer register			R
000082 _H	PPG1 - Period setting register		PCSR1	W
000083 _H	PPG1 - Period setting register			W
000084 _H	PPG1 - Duty cycle register		PDUT1	W
000085 _H	PPG1 - Duty cycle register			W
000086 _H	PPG1 - Control status register Low	PCNL1	PCN1	R/W
000087 _H	PPG1 - Control status register High	PCNH1		R/W
000088 _H 00008F _H	Reserved			-
000090 _H	PPG3 - Timer register		PTMR3	R
000091 _H	PPG3 - Timer register			R
000092 _H	PPG3 - Period setting register		PCSR3	W
000093 _H	PPG3 - Period setting register			W
000094 _H	PPG3 - Duty cycle register		PDUT3	W
000095 _H	PPG3 - Duty cycle register			W
000096 _H	PPG3 - Control status register Low	PCNL3	PCN3	R/W

I/O map CY96(F)315x (Sheet 5 of 22)

Address	Register	Abbreviation 8-bit access	Abbreviation 16-bit access	Access
000097 _H	PPG3 - Control status register High	PCNH3		R/W
000098 _H	PPG7-PPG4 - General Control register 1 Low	GCN1L1	GCN11	R/W
000099 _H	PPG7-PPG4 - General Control register 1 High	GCN1H1		R/W
00009A _H	PPG7-PPG4 - General Control register 2 Low	GCN2L1	GCN21	R/W
00009B _H	PPG7-PPG4 - General Control register 2 High	GCN2H1		R/W
00009C _H	PPG4 - Timer register		PTMR4	R
00009D _H	PPG4 - Timer register			R
00009E _H	PPG4 - Period setting register		PCSR4	W
00009F _H	PPG4 - Period setting register			W
0000A0 _H	PPG4 - Duty cycle register		PDUT4	W
0000A1 _H	PPG4 - Duty cycle register			W
0000A2 _H	PPG4 - Control status register Low	PCNL4	PCN4	R/W
0000A3 _H	PPG4 - Control status register High	PCNH4		R/W
0000A4 _H - 0000D3 _H	Reserved			-
0000D4 _H	USART2 - Serial Mode Register	SMR2		R/W
0000D5 _H	USART2 - Serial Control Register	SCR2		R/W
0000D6 _H	USART2 - TX Register	TDR2		W
0000D6 _H	USART2 - RX Register	RDR2		R
0000D7 _H	USART2 - Serial Status	SSR2		R/W
0000D8 _H	USART2 - Control/Com. Register	ECCR2		R/W
0000D9 _H	USART2 - Ext. Status Register	ESCR2		R/W
0000DA _H	USART2 - Baud Rate Generator Register Low	BGRL2	BGR2	R/W
0000DB _H	USART2 - Baud Rate Generator Register High	BGRH2		R/W
0000DC _H	USART2 - Extended Serial Interrupt Register	ESIR2		R/W
0000DD _H - 0000FF _H	Reserved			-
000100 _H	DMA0 - Buffer address pointer low byte	BAPL0		R/W
000101 _H	DMA0 - Buffer address pointer middle byte	BAPM0		R/W
000102 _H	DMA0 - Buffer address pointer high byte	BAPH0		R/W
000103 _H	DMA0 - DMA control register	DMACS0		R/W

I/O map CY96(F)315x (Sheet 6 of 22)

Address	Register	Abbreviation 8-bit access	Abbreviation 16-bit access	Access
000104 _H	DMA0 - I/O register address pointer low byte	IOAL0	IOA0	R/W
000105 _H	DMA0 - I/O register address pointer high byte	IOAH0		R/W
000106 _H	DMA0 - Data counter low byte	DCTL0	DCT0	R/W
000107 _H	DMA0 - Data counter high byte	DCTH0		R/W
000108 _H	DMA1 - Buffer address pointer low byte	BAPL1		R/W
000109 _H	DMA1 - Buffer address pointer middle byte	BAPM1		R/W
00010A _H	DMA1 - Buffer address pointer high byte	BAPH1		R/W
00010B _H	DMA1 - DMA control register	DMACS1		R/W
00010C _H	DMA1 - I/O register address pointer low byte	IOAL1	IOA1	R/W
00010D _H	DMA1 - I/O register address pointer high byte	IOAH1		R/W
00010E _H	DMA1 - Data counter low byte	DCTL1	DCT1	R/W
00010F _H	DMA1 - Data counter high byte	DCTH1		R/W
000110 _H	DMA2 - Buffer address pointer low byte	BAPL2		R/W
000111 _H	DMA2 - Buffer address pointer middle byte	BAPM2		R/W
000112 _H	DMA2 - Buffer address pointer high byte	BAPH2		R/W
000113 _H	DMA2 - DMA control register	DMACS2		R/W
000114 _H	DMA2 - I/O register address pointer low byte	IOAL2	IOA2	R/W
000115 _H	DMA2 - I/O register address pointer high byte	IOAH2		R/W
000116 _H	DMA2 - Data counter low byte	DCTL2	DCT2	R/W
000117 _H	DMA2 - Data counter high byte	DCTH2		R/W
000118 _H	DMA3 - Buffer address pointer low byte	BAPL3		R/W
000119 _H	DMA3 - Buffer address pointer middle byte	BAPM3		R/W
00011A _H	DMA3 - Buffer address pointer high byte	BAPH3		R/W
00011B _H	DMA3 - DMA control register	DMACS3		R/W
00011C _H	DMA3 - I/O register address pointer low byte	IOAL3	IOA3	R/W
00011D _H	DMA3 - I/O register address pointer high byte	IOAH3		R/W
00011E _H	DMA3 - Data counter low byte	DCTL3	DCT3	R/W
00011F _H	DMA3 - Data counter high byte	DCTH3		R/W
000120 _H - 00017F _H	Reserved			-

I/O map CY96(F)315x (Sheet 7 of 22)

Address	Register	Abbreviation 8-bit access	Abbreviation 16-bit access	Access
000180 _H - 00037F _H	CPU - General Purpose registers (RAM access)	GPR_RAM		R/W
000380 _H	DMA0 - Interrupt select	DISEL0		R/W
000381 _H	DMA1 - Interrupt select	DISEL1		R/W
000382 _H	DMA2 - Interrupt select	DISEL2		R/W
000383 _H	DMA3 - Interrupt select	DISEL3		R/W
000384 _H - 00038F _H	Reserved			-
000390 _H	DMA - Status register low byte	DSRL	DSR	R/W
000391 _H	DMA - Status register high byte	DSRH		R/W
000392 _H	DMA - Stop status register low byte	DSSRL	DSSR	R/W
000393 _H	DMA - Stop status register high byte	DSSRH		R/W
000394 _H	DMA - Enable register low byte	DERL	DER	R/W
000395 _H	DMA - Enable register high byte	DERH		R/W
000396 _H - 00039F _H	Reserved			-
0003A0 _H	Interrupt level register	ILR	ICR	R/W
0003A1 _H	Interrupt index register	IDX		R/W
0003A2 _H	Interrupt vector table base register Low	TBRL	TBR	R/W
0003A3 _H	Interrupt vector table base register High	TBRH		R/W
0003A4 _H	Delayed Interrupt register	DIRR		R/W
0003A5 _H	Non Maskable Interrupt register	NMI		R/W
0003A6 _H - 0003AB _H	Reserved			-
0003AC _H	EDSU communication interrupt selection Low	EDSU2L	EDSU2	R/W
0003AD _H	EDSU communication interrupt selection High	EDSU2H		R/W
0003AE _H	ROM mirror control register	ROMM		R/W
0003AF _H	EDSU configuration register	EDSU		R/W
0003B0 _H	Memory patch control/status register ch 0/1		PFCS0	R/W
0003B1 _H	Memory patch control/status register ch 0/1			R/W
0003B2 _H	Memory patch control/status register ch 2/3		PFCS1	R/W
0003B3 _H	Memory patch control/status register ch 2/3			R/W

I/O map CY96(F)315x (Sheet 8 of 22)

Address	Register	Abbreviation 8-bit access	Abbreviation 16-bit access	Access
0003B4 _H	Memory patch control/status register ch 4/5		PFCS2	R/W
0003B5 _H	Memory patch control/status register ch 4/5			R/W
0003B6 _H	Memory patch control/status register ch 6/7		PFCS3	R/W
0003B7 _H	Memory patch control/status register ch 6/7			R/W
0003B8 _H	Memory Patch function - Patch address 0 low	PFAL0		R/W
0003B9 _H	Memory Patch function - Patch address 0 middle	PFAM0		R/W
0003BA _H	Memory Patch function - Patch address 0 high	PFAH0		R/W
0003BB _H	Memory Patch function - Patch address 1 low	PFAL1		R/W
0003BC _H	Memory Patch function - Patch address 1 middle	PFAM1		R/W
0003BD _H	Memory Patch function - Patch address 1 high	PFAH1		R/W
0003BE _H	Memory Patch function - Patch address 2 low	PFAL2		R/W
0003BF _H	Memory Patch function - Patch address 2 middle	PFAM2		R/W
0003C0 _H	Memory Patch function - Patch address 2 high	PFAH2		R/W
0003C1 _H	Memory Patch function - Patch address 3 low	PFAL3		R/W
0003C2 _H	Memory Patch function - Patch address 3 middle	PFAM3		R/W
0003C3 _H	Memory Patch function - Patch address 3 high	PFAH3		R/W
0003C4 _H	Memory Patch function - Patch address 4 low	PFAL4		R/W
0003C5 _H	Memory Patch function - Patch address 4 middle	PFAM4		R/W
0003C6 _H	Memory Patch function - Patch address 4 high	PFAH4		R/W
0003C7 _H	Memory Patch function - Patch address 5 low	PFAL5		R/W
0003C8 _H	Memory Patch function - Patch address 5 middle	PFAM5		R/W
0003C9 _H	Memory Patch function - Patch address 5 high	PFAH5		R/W
0003CA _H	Memory Patch function - Patch address 6 low	PFAL6		R/W
0003CB _H	Memory Patch function - Patch address 6 middle	PFAM6		R/W
0003CC _H	Memory Patch function - Patch address 6 high	PFAH6		R/W
0003CD _H	Memory Patch function - Patch address 7 low	PFAL7		R/W
0003CE _H	Memory Patch function - Patch address 7 middle	PFAM7		R/W
0003CF _H	Memory Patch function - Patch address 7 high	PFAH7		R/W
0003D0 _H	Memory Patch function - Patch data 0 Low	PFDL0	PFD0	R/W
0003D1 _H	Memory Patch function - Patch data 0 High	PFDH0		R/W

I/O map CY96(F)315x (Sheet 9 of 22)

Address	Register	Abbreviation 8-bit access	Abbreviation 16-bit access	Access
0003D2 _H	Memory Patch function - Patch data 1 Low	PFDL1	PFD1	R/W
0003D3 _H	Memory Patch function - Patch data 1 High	PFDH1		R/W
0003D4 _H	Memory Patch function - Patch data 2 Low	PFDL2	PFD2	R/W
0003D5 _H	Memory Patch function - Patch data 2 High	PFDH2		R/W
0003D6 _H	Memory Patch function - Patch data 3 Low	PFDL3	PFD3	R/W
0003D7 _H	Memory Patch function - Patch data 3 High	PFDH3		R/W
0003D8 _H	Memory Patch function - Patch data 4 Low	PFDL4	PFD4	R/W
0003D9 _H	Memory Patch function - Patch data 4 High	PFDH4		R/W
0003DA _H	Memory Patch function - Patch data 5 Low	PFDL5	PFD5	R/W
0003DB _H	Memory Patch function - Patch data 5 High	PFDH5		R/W
0003DC _H	Memory Patch function - Patch data 6 Low	PFDL6	PFD6	R/W
0003DD _H	Memory Patch function - Patch data 6 High	PFDH6		R/W
0003DE _H	Memory Patch function - Patch data 7 Low	PFDL7	PFD7	R/W
0003DF _H	Memory Patch function - Patch data 7 High	PFDH7		R/W
0003E0 _H - 0003F0 _H	Reserved			-
0003F1 _H	Memory Control Status Register A	MCSRA		R/W
0003F2 _H	Memory Timing Configuration Register A Low	MTCRAL	MTCRA	R/W
0003F3 _H	Memory Timing Configuration Register A High	MTCRAH		R/W
0003F4 _H - 0003F8 _H	Reserved			-
0003F9 _H	Flash Memory Write Control register 1	FMWC1		R/W
0003FA _H	Flash Memory Write Control register 2	FMWC2		R/W
0003FB _H	Flash Memory Write Control register 3	FMWC3		R/W
0003FC _H	Flash Memory Write Control register 4	FMWC4		R/W
0003FD _H	Flash Memory Write Control register 5	FMWC5		R/W
0003FE _H - 0003FF _H	Reserved			-
000400 _H	Standby Mode control register	SMCR		R/W
000401 _H	Clock select register	CKSR		R/W
000402 _H	Clock Stabilization select register	CKSSR		R/W
000403 _H	Clock monitor register	CKMR		R

I/O map CY96(F)315x (Sheet 10 of 22)

Address	Register	Abbreviation 8-bit access	Abbreviation 16-bit access	Access
000404 _H	Clock Frequency control register Low	CKFCRL	CKFCR	R/W
000405 _H	Clock Frequency control register High	CKFCRH		R/W
000406 _H	PLL Control register Low	PLLCRL	PLLCR	R/W
000407 _H	PLL Control register High	PLLCRH		R/W
000408 _H	RC clock timer control register	RCTCR		R/W
000409 _H	Main clock timer control register	MCTCR		R/W
00040A _H	Sub clock timer control register	SCTCR		R/W
00040B _H	Reset cause and clock status register with clear function	RCCSRC		R
00040C _H	Reset configuration register	RCR		R/W
00040D _H	Reset cause and clock status register	RCCSR		R
00040E _H	Watch dog timer configuration register	WDTC		R/W
00040F _H	Watch dog timer clear pattern register	WDTCP		W
000410 _H - 000414 _H	Reserved			-
000415 _H	Clock output activation register	COAR		R/W
000416 _H	Clock output configuration register 0	COCR0		R/W
000417 _H	Clock output configuration register 1	COCR1		R/W
000418 _H	Clock Modulator control register	CMCR		R/W
000419 _H	Reserved			-
00041A _H	Clock Modulator Parameter register Low	CMPRL	CMPR	R/W
00041B _H	Clock Modulator Parameter register High	CMPRH		R/W
00041C _H - 00042B _H	Reserved			-
00042C _H	Voltage Regulator Control register	VRCR		R/W
00042D _H	Clock Input and LVD Control Register	CILCR		R/W
00042E _H - 00042F _H	Reserved			-
000430 _H	I/O Port P00 - Data Direction Register	DDR00		R/W
000431 _H	I/O Port P01 - Data Direction Register	DDR01		R/W
000432 _H	I/O Port P02 - Data Direction Register	DDR02		R/W
000433 _H	I/O Port P03 - Data Direction Register	DDR03		R/W
000434 _H	Reserved			-

I/O map CY96(F)315x (Sheet 11 of 22)

Address	Register	Abbreviation 8-bit access	Abbreviation 16-bit access	Access
000435 _H	I/O Port P05 - Data Direction Register	DDR05		R/W
000436 _H	I/O Port P06 - Data Direction Register	DDR06		R/W
000437 _H	I/O Port P07 - Data Direction Register	DDR07		R/W
000438 _H - 000443 _H	Reserved			-
000444 _H	I/O Port P00 - Port Input Enable Register	PIER00		R/W
000445 _H	I/O Port P01 - Port Input Enable Register	PIER01		R/W
000446 _H	I/O Port P02 - Port Input Enable Register	PIER02		R/W
000447 _H	I/O Port P03 - Port Input Enable Register	PIER03		R/W
000448 _H	Reserved			-
000449 _H	I/O Port P05 - Port Input Enable Register	PIER05		R/W
00044A _H	I/O Port P06 - Port Input Enable Register	PIER06		R/W
00044B _H	I/O Port P07 - Port Input Enable Register	PIER07		R/W
00044C _H - 000457 _H	Reserved			-
000458 _H	I/O Port P00 - Port Input Level Register	PILR00		R/W
000459 _H	I/O Port P01 - Port Input Level Register	PILR01		R/W
00045A _H	I/O Port P02 - Port Input Level Register	PILR02		R/W
00045B _H	I/O Port P03 - Port Input Level Register	PILR03		R/W
00045C _H	Reserved			-
00045D _H	I/O Port P05 - Port Input Level Register	PILR05		R/W
00045E _H	I/O Port P06 - Port Input Level Register	PILR06		R/W
00045F _H	I/O Port P07 - Port Input Level Register	PILR07		R/W
000460 _H - 00046B _H	Reserved			-
00046C _H	I/O Port P00 - Extended Port Input Level Register	EPILR00		R/W
00046D _H	I/O Port P01 - Extended Port Input Level Register	EPILR01		R/W
00046E _H	I/O Port P02 - Extended Port Input Level Register	EPILR02		R/W
00046F _H	I/O Port P03 - Extended Port Input Level Register	EPILR03		R/W
000470 _H	Reserved			-
000471 _H	I/O Port P05 - Extended Port Input Level Register	EPILR05		R/W
000472 _H	I/O Port P06 - Extended Port Input Level Register	EPILR06		R/W

I/O map CY96(F)315x (Sheet 12 of 22)

Address	Register	Abbreviation 8-bit access	Abbreviation 16-bit access	Access
000473 _H	I/O Port P07 - Extended Port Input Level Register	EPILR07		R/W
000474 _H - 00047F _H	Reserved			-
000480 _H	I/O Port P00 - Port Output Drive Register	PODR00		R/W
000481 _H	I/O Port P01 - Port Output Drive Register	PODR01		R/W
000482 _H	I/O Port P02 - Port Output Drive Register	PODR02		R/W
000483 _H	I/O Port P03 - Port Output Drive Register	PODR03		R/W
000484 _H	Reserved			-
000485 _H	I/O Port P05 - Port Output Drive Register	PODR05		R/W
000486 _H	I/O Port P06 - Port Output Drive Register	PODR06		R/W
000487 _H	I/O Port P07 - Port Output Drive Register	PODR07		R/W
000488 _H - 0004A7 _H	Reserved			-
0004A8 _H	I/O Port P00 - Pull-Up resistor Control Register	PUCR00		R/W
0004A9 _H	I/O Port P01 - Pull-Up resistor Control Register	PUCR01		R/W
0004AA _H	I/O Port P02 - Pull-Up resistor Control Register	PUCR02		R/W
0004AB _H	I/O Port P03 - Pull-Up resistor Control Register	PUCR03		R/W
0004AC _H	Reserved			-
0004AD _H	I/O Port P05 - Pull-Up resistor Control Register	PUCR05		R/W
0004AE _H	I/O Port P06 - Pull-Up resistor Control Register	PUCR06		R/W
0004AF _H	I/O Port P07 - Pull-Up resistor Control Register	PUCR07		R/W
0004B0 _H - 0004BB _H	Reserved			-
0004BC _H	I/O Port P00 - External Pin State Register	EPSR00		R
0004BD _H	I/O Port P01 - External Pin State Register	EPSR01		R
0004BE _H	I/O Port P02 - External Pin State Register	EPSR02		R
0004BF _H	I/O Port P03 - External Pin State Register	EPSR03		R
0004C0 _H	Reserved			-
0004C1 _H	I/O Port P05 - External Pin State Register	EPSR05		R
0004C2 _H	I/O Port P06 - External Pin State Register	EPSR06		R
0004C3 _H	I/O Port P07 - External Pin State Register	EPSR07		R

I/O map CY96(F)315x (Sheet 13 of 22)

Address	Register	Abbreviation 8-bit access	Abbreviation 16-bit access	Access
0004C4 _H - 0004CF _H	Reserved			-
0004D0 _H	ADC analog input enable register 0	ADER0		R/W
0004D1 _H	ADC analog input enable register 1	ADER1		R/W
0004D2 _H	ADC analog input enable register 2	ADER2		R/W
0004D3 _H	ADC analog input enable register 3	ADER3		R/W
0004D4 _H	ADC analog input enable register 4	ADER4		R/W
0004D5 _H	Reserved			-
0004D6 _H	Peripheral Resource Relocation Register 0	PRRR0		R/W
0004D7 _H	Peripheral Resource Relocation Register 1	PRRR1		R/W
0004D8 _H	Peripheral Resource Relocation Register 2	PRRR2		R/W
0004D9 _H	Peripheral Resource Relocation Register 3	PRRR3		R/W
0004DA _H	Peripheral Resource Relocation Register 4	PRRR4		R/W
0004DB _H	Peripheral Resource Relocation Register 5	PRRR5		R/W
0004DC _H	Peripheral Resource Relocation Register 6	PRRR6		R/W
0004DD _H	Peripheral Resource Relocation Register 7	PRRR7		R/W
0004DE _H	Peripheral Resource Relocation Register 8	PRRR8		R/W
0004DF _H	Peripheral Resource Relocation Register 9	PRRR9		R/W
0004E0 _H	RTC - Sub Second Register L	WTBRL0	WTBR0	R/W
0004E1 _H	RTC - Sub Second Register M	WTBRH0		R/W
0004E2 _H	RTC - Sub-Second Register H	WTBR1		R/W
0004E3 _H	RTC - Second Register	WTSR		R/W
0004E4 _H	RTC - Minutes	WTMR		R/W
0004E5 _H	RTC - Hour	WTHR		R/W
0004E6 _H	RTC - Timer Control Extended Register	WTCER		R/W
0004E7 _H	RTC - Clock select register	WTCKSR		R/W
0004E8 _H	RTC - Timer Control Register Low	WTCRL	WTCR	R/W
0004E9 _H	RTC - Timer Control Register High	WTCRH		R/W
0004EA _H	CAL - Calibration unit Control register	CUCR		R/W
0004EB _H	Reserved			-
0004EC _H	CAL - Duration Timer Data Register Low	CUTDL	CUTD	R/W

I/O map CY96(F)315x (Sheet 14 of 22)

Address	Register	Abbreviation 8-bit access	Abbreviation 16-bit access	Access
0004ED _H	CAL - Duration Timer Data Register High	CUTDH		R/W
0004EE _H	CAL - Calibration Timer Register 2 Low	CUTR2L	CUTR2	R
0004EF _H	CAL - Calibration Timer Register 2 High	CUTR2H		R
0004F0 _H	CAL - Calibration Timer Register 1 Low	CUTR1L	CUTR1	R
0004F1 _H	CAL - Calibration Timer Register 1 High	CUTR1H		R
0004F2 _H - 0004F9 _H	Reserved			-
0004FA _H	RLT - Timer input select (for Cascading)	TMISR		R/W
0004FB _H -00 04FF _H	Reserved			-
000500 _H	FRT2 - Data register of free-running timer		TCDT2	R/W
000501 _H	FRT2 - Data register of free-running timer			R/W
000502 _H	FRT2 - Control status register of free-running timer Low	TCCSL2	TCCS2	R/W
000503 _H	FRT2 - Control status register of free-running timer High	TCCSH2		R/W
000504 _H	FRT3 - Data register of free-running timer		TCDT3	R/W
000505 _H	FRT3 - Data register of free-running timer			R/W
000506 _H	FRT3 - Control status register of free-running timer Low	TCCSL3	TCCS3	R/W
000507 _H	FRT3 - Control status register of free-running timer High	TCCSH3		R/W
000508 _H - 000513 _H	Reserved			-
000514 _H	ICU8/ICU9 - Control Status Register	ICS89		R/W
000515 _H	ICU8/ICU9 - Edge Register	ICE89		R/W
000516 _H	ICU8 - Capture Register Low	IPCPL8	IPCP8	R
000517 _H	ICU8 - Capture Register High	ICPH8		R
000518 _H	ICU9 - Capture Register Low	IPCPL9	IPCP9	R
000519 _H	ICU9 - Capture Register High	ICPH9		R
00051A _H	ICU10/ICU11 - Control Status Register	ICS1011		R/W
00051B _H	ICU10/ICU11 - Edge Register	ICE1011		R/W
00051C _H	ICU10 - Capture Register Low	IPCPL10	IPCP10	R
00051D _H	ICU10 - Capture Register High	ICPH10		R
00051E _H	ICU11 - Capture Register Low	IPCPL11	IPCP11	R
00051F _H	ICU11 - Capture Register High	ICPH11		R

I/O map CY96(F)315x (Sheet 15 of 22)

Address	Register	Abbreviation 8-bit access	Abbreviation 16-bit access	Access
000520 _H - 00053D _H	Reserved			-
00053E _H	USART7 - Serial Mode Register	SMR7		R/W
00053F _H	USART7 - Serial Control Register	SCR7		R/W
000540 _H	USART7 - Serial TX Register	TDR7		W
000540 _H	USART7 - Serial RX Register	RDR7		R
000541 _H	USART7 - Serial Status Register	SSR7		R/W
000542 _H	USART7 - Ext. Control/Com. Register	ECCR7		R/W
000543 _H	USART7 - Ext. Status Com. Register	ESCR7		R/W
000544 _H	USART7 - Baud Rate Generator Register Low	BGRL7	BGR7	R/W
000545 _H	USART7 - Baud Rate Generator Register High	BGRH7		R/W
000546 _H	USART7 - Extended Serial Interrupt Register	ESIR7		R/W
000547 _H	Reserved			-
000548 _H	USART8 - Serial Mode Register	SMR8		R/W
000549 _H	USART8 - Serial Control Register	SCR8		R/W
00054A _H	USART8 - Serial TX Register	TDR8		W
00054A _H	USART8 - Serial RX Register	RDR8		R
00054B _H	USART8 - Serial Status Register	SSR8		R/W
00054C _H	USART8 - Ext. Control/Com. Register	ECCR8		R/W
00054D _H	USART8 - Ext. Status Com. Register	ESCR8		R/W
00054E _H	USART8 - Baud Rate Generator Register Low	BGRL8	BGR8	R/W
00054F _H	USART8 - Baud Rate Generator Register High	BGRH8		R/W
000550 _H	USART8 - Extended Serial Interrupt Register	ESIR8		R/W
000551 _H - 000563 _H	Reserved			-
000564 _H	PPG6 - Timer register		PTMR6	R
000565 _H	PPG6 - Timer register			R
000566 _H	PPG6 - Period setting register		PCSR6	W
000567 _H	PPG6 - Period setting register			W
000568 _H	PPG6 - Duty cycle register		PDUT6	W
000569 _H	PPG6 - Duty cycle register			W

I/O map CY96(F)315x (Sheet 16 of 22)

Address	Register	Abbreviation 8-bit access	Abbreviation 16-bit access	Access
00056A _H	PPG6 - Control status register Low	PCNL6	PCN6	R/W
00056B _H	PPG6 - Control status register High	PCNH6		R/W
00056C _H	PPG7 - Timer register		PTMR7	R
00056D _H	PPG7 - Timer register			R
00056E _H	PPG7 - Period setting register		PCSR7	W
00056F _H	PPG7 - Period setting register			W
000570 _H	PPG7 - Duty cycle register		PDUT7	W
000571 _H	PPG7 - Duty cycle register			W
000572 _H	PPG7 - Control status register Low	PCNL7	PCN7	R/W
000573 _H	PPG7 - Control status register High	PCNH7		R/W
000574 _H	PPG11-PPG8 - General Control register 1 Low	GCN1L2	GCN12	R/W
000575 _H	PPG11-PPG8 - General Control register 1 High	GCN1H2		R/W
000576 _H	PPG11-PPG8 - General Control register 2 Low	GCN2L2	GCN22	R/W
000577 _H	PPG11-PPG8 - General Control register 2 High	GCN2H2		R/W
000578 _H	PPG8 - Timer register		PTMR8	R
000579 _H	PPG8 - Timer register			R
00057A _H	PPG8 - Period setting register		PCSR8	W
00057B _H	PPG8 - Period setting register			W
00057C _H	PPG8 - Duty cycle register		PDUT8	W
00057D _H	PPG8 - Duty cycle register			W
00057E _H	PPG8 - Control status register Low	PCNL8	PCN8	R/W
00057F _H	PPG8 - Control status register High	PCNH8		R/W
000580 _H	PPG9 - Timer register		PTMR9	R
000581 _H	PPG9 - Timer register			R
000582 _H	PPG9 - Period setting register		PCSR9	W
000583 _H	PPG9 - Period setting register			W
000584 _H	PPG9 - Duty cycle register		PDUT9	W
000585 _H	PPG9 - Duty cycle register			W
000586 _H	PPG9 - Control status register Low	PCNL9	PCN9	R/W
000587 _H	PPG9 - Control status register High	PCNH9		R/W

I/O map CY96(F)315x (Sheet 17 of 22)

Address	Register	Abbreviation 8-bit access	Abbreviation 16-bit access	Access
000588 _H - 000597 _H	Reserved			-
000598 _H	PPG15-PPG12 - General Control register 1 Low	GCN1L3	GCN13	R/W
000599 _H	PPG15-PPG12 - General Control register 1 High	GCN1H3		R/W
00059A _H	PPG15-PPG12 - General Control register 2 Low	GCN2L3	GCN23	R/W
00059B _H	PPG15-PPG12 - General Control register 2 High	GCN2H3		R/W
00059C _H	PPG12 - Timer register		PTMR12	R
00059D _H	PPG12 - Timer register			R
00059E _H	PPG12 - Period setting register		PCSR12	W
00059F _H	PPG12 - Period setting register			W
0005A0 _H	PPG12 - Duty cycle register		PDUT12	W
0005A1 _H	PPG12 - Duty cycle register			W
0005A2 _H	PPG12 - Control status register Low	PCNL12	PCN12	R/W
0005A3 _H	PPG12 - Control status register High	PCNH12		R/W
0005A4 _H - 0005AB _H	Reserved			-
0005AC _H	PPG14 - Timer register		PTMR14	R
0005AD _H	PPG14 - Timer register			R
0005AE _H	PPG14 - Period setting register		PCSR14	W
0005AF _H	PPG14 - Period setting register			W
0005B0 _H	PPG14 - Duty cycle register		PDUT14	W
0005B1 _H	PPG14 - Duty cycle register			W
0005B2 _H	PPG14 - Control status register Low	PCNL14	PCN14	R/W
0005B3 _H	PPG14 - Control status register High	PCNH14		R/W
0005B4 _H - 0005BB _H	Reserved			-
0005BC _H	PPG19-PPG16 - General Control register 1 Low	GCN1L4	GCN14	R/W
0005BD _H	PPG19-PPG16 - General Control register 1 High	GCN1H4		R/W
0005BE _H	PPG19-PPG16 - General Control register 2 Low	GCN2L4	GCN24	R/W
0005BF _H	PPG19-PPG16 - General Control register 2 High	GCN2H4		R/W
0005C0 _H	PPG16 - Timer register		PTMR16	R
0005C1 _H	PPG16 - Timer register			R

I/O map CY96(F)315x (Sheet 18 of 22)

Address	Register	Abbreviation 8-bit access	Abbreviation 16-bit access	Access
0005C2 _H	PPG16 - Period setting register		PCSR16	W
0005C3 _H	PPG16 - Period setting register			W
0005C4 _H	PPG16 - Duty cycle register		PDUT16	W
0005C5 _H	PPG16 - Duty cycle register			W
0005C6 _H	PPG16 - Control status register Low	PCNL16	PCN16	R/W
0005C7 _H	PPG16 - Control status register High	PCNH16		R/W
0005C8 _H	PPG17 - Timer register		PTMR17	R
0005C9 _H	PPG17 - Timer register			R
0005CA _H	PPG17 - Period setting register		PCSR17	W
0005CB _H	PPG17 - Period setting register			W
0005CC _H	PPG17 - Duty cycle register		PDUT17	W
0005CD _H	PPG17 - Duty cycle register			W
0005CE _H	PPG17 - Control status register Low	PCNL17	PCN17	R/W
0005CF _H	PPG17 - Control status register High	PCNH17		R/W
0005D0 _H	PPG18 - Timer register		PTMR18	R
0005D1 _H	PPG18 - Timer register			R
0005D2 _H	PPG18 - Period setting register		PCSR18	W
0005D3 _H	PPG18 - Period setting register			W
0005D4 _H	PPG18 - Duty cycle register		PDUT18	W
0005D5 _H	PPG18 - Duty cycle register			W
0005D6 _H	PPG18 - Control status register Low	PCNL18	PCN18	R/W
0005D7 _H	PPG18 - Control status register High	PCNH18		R/W
0005D8 _H	PPG19 - Timer register		PTMR19	R
0005D9 _H	PPG19 - Timer register			R
0005DA _H	PPG19 - Period setting register		PCSR19	W
0005DB _H	PPG19 - Period setting register			W
0005DC _H	PPG19 - Duty cycle register		PDUT19	W
0005DD _H	PPG19 - Duty cycle register			W
0005DE _H	PPG19 - Control status register Low	PCNL19	PCN19	R/W
0005DF _H	PPG19 - Control status register High	PCNH19		R/W

I/O map CY96(F)315x (Sheet 19 of 22)

Address	Register	Abbreviation 8-bit access	Abbreviation 16-bit access	Access
0005E0 _H - 00065F _H	Reserved			-
000660 _H	Peripheral Resource Relocation Register 10	PRRR10		R/W
000661 _H	Peripheral Resource Relocation Register 11	PRRR11		R/W
000662 _H	Peripheral Resource Relocation Register 12	PRRR12		R/W
000663 _H	Peripheral Resource Relocation Register 13	PRRR13		W
000664 _H - 0008FF _H	Reserved			-
000900 _H	CAN2 - Control register Low	CTRLRL2	CTRLR2	R/W
000901 _H	CAN2 - Control register High (reserved)	CTRLRH2		R
000902 _H	CAN2 - Status register Low	STATRL2	STATR2	R/W
000903 _H	CAN2 - Status register High (reserved)	STATRH2		R
000904 _H	CAN2 - Error Counter Low (Transmit)	ERRCNTL2	ERRCNT2	R
000905 _H	CAN2 - Error Counter High (Receive)	ERRCNTH2		R
000906 _H	CAN2 - Bit Timing Register Low	BTRL2	BTR2	R/W
000907 _H	CAN2 - Bit Timing Register High	BTRH2		R/W
000908 _H	CAN2 - Interrupt Register Low	INTRL2	INTR2	R
000909 _H	CAN2 - Interrupt Register High	INTRH2		R
00090A _H	CAN2 - Test Register Low	TESTRL2	TESTR2	R/W
00090B _H	CAN2 - Test Register High (reserved)	TESTRH2		R
00090C _H	CAN2 - BRP Extension register Low	BRPERL2	BRPER2	R/W
00090D _H	CAN2 - BRP Extension register High (reserved)	BRPERH2		R
00090E _H - 00090F _H	Reserved			-
000910 _H	CAN2 - IF1 Command request register Low	IF1CREQL2	IF1CREQ2	R/W
000911 _H	CAN2 - IF1 Command request register High	IF1CREQH2		R/W
000912 _H	CAN2 - IF1 Command Mask register Low	IF1CMSKL2	IF1CMSK2	R/W
000913 _H	CAN2 - IF1 Command Mask register High (reserved)	IF1CMSKH2		R
000914 _H	CAN2 - IF1 Mask 1 Register Low	IF1MSK1L2	IF1MSK12	R/W
000915 _H	CAN2 - IF1 Mask 1 Register High	IF1MSK1H2		R/W
000916 _H	CAN2 - IF1 Mask 2 Register Low	IF1MSK2L2	IF1MSK22	R/W
000917 _H	CAN2 - IF1 Mask 2 Register High	IF1MSK2H2		R/W

I/O map CY96(F)315x (Sheet 20 of 22)

Address	Register	Abbreviation 8-bit access	Abbreviation 16-bit access	Access
000918 _H	CAN2 - IF1 Arbitration 1 Register Low	IF1ARB1L2	IF1ARB12	R/W
000919 _H	CAN2 - IF1 Arbitration 1 Register High	IF1ARB1H2		R/W
00091A _H	CAN2 - IF1 Arbitration 2 Register Low	IF1ARB2L2	IF1ARB22	R/W
00091B _H	CAN2 - IF1 Arbitration 2 Register High	IF1ARB2H2		R/W
00091C _H	CAN2 - IF1 Message Control Register Low	IF1MCTRL2	IF1MCTR2	R/W
00091D _H	CAN2 - IF1 Message Control Register High	IF1MCTRH2		R/W
00091E _H	CAN2 - IF1 Data A1 Low	IF1DTA1L2	IF1DTA12	R/W
00091F _H	CAN2 - IF1 Data A1 High	IF1DTA1H2		R/W
000920 _H	CAN2 - IF1 Data A2 Low	IF1DTA2L2	IF1DTA22	R/W
000921 _H	CAN2 - IF1 Data A2 High	IF1DTA2H2		R/W
000922 _H	CAN2 - IF1 Data B1 Low	IF1DTB1L2	IF1DTB12	R/W
000923 _H	CAN2 - IF1 Data B1 High	IF1DTB1H2		R/W
000924 _H	CAN2 - IF1 Data B2 Low	IF1DTB2L2	IF1DTB22	R/W
000925 _H	CAN2 - IF1 Data B2 High	IF1DTB2H2		R/W
000926 _H - 00093F _H	Reserved			-
000940 _H	CAN2 - IF2 Command request register Low	IF2CREQL2	IF2CREQ2	R/W
000941 _H	CAN2 - IF2 Command request register High	IF2CREQH2		R/W
000942 _H	CAN2 - IF2 Command Mask register Low	IF2CMSKL2	IF2CMSK2	R/W
000943 _H	CAN2 - IF2 Command Mask register High (reserved)	IF2CMSKH2		R
000944 _H	CAN2 - IF2 Mask 1 Register Low	IF2MSK1L2	IF2MSK12	R/W
000945 _H	CAN2 - IF2 Mask 1 Register High	IF2MSK1H2		R/W
000946 _H	CAN2 - IF2 Mask 2 Register Low	IF2MSK2L2	IF2MSK22	R/W
000947 _H	CAN2 - IF2 Mask 2 Register High	IF2MSK2H2		R/W
000948 _H	CAN2 - IF2 Arbitration 1 Register Low	IF2ARB1L2	IF2ARB12	R/W
000949 _H	CAN2 - IF2 Arbitration 1 Register High	IF2ARB1H2		R/W
00094A _H	CAN2 - IF2 Arbitration 2 Register Low	IF2ARB2L2	IF2ARB22	R/W
00094B _H	CAN2 - IF2 Arbitration 2 Register High	IF2ARB2H2		R/W
00094C _H	CAN2 - IF2 Message Control Register Low	IF2MCTRL2	IF2MCTR2	R/W
00094D _H	CAN2 - IF2 Message Control Register High	IF2MCTRH2		R/W
00094E _H	CAN2 - IF2 Data A1 Low	IF2DTA1L2	IF2DTA12	R/W

I/O map CY96(F)315x (Sheet 21 of 22)

Address	Register	Abbreviation 8-bit access	Abbreviation 16-bit access	Access
00094F _H	CAN2 - IF2 Data A1 High	IF2DTA1H2		R/W
000950 _H	CAN2 - IF2 Data A2 Low	IF2DTA2L2	IF2DTA22	R/W
000951 _H	CAN2 - IF2 Data A2 High	IF2DTA2H2		R/W
000952 _H	CAN2 - IF2 Data B1 Low	IF2DTB1L2	IF2DTB12	R/W
000953 _H	CAN2 - IF2 Data B1 High	IF2DTB1H2		R/W
000954 _H	CAN2 - IF2 Data B2 Low	IF2DTB2L2	IF2DTB22	R/W
000955 _H	CAN2 - IF2 Data B2 High	IF2DTB2H2		R/W
000956 _H - 00097F _H	Reserved			-
000980 _H	CAN2 - Transmission Request 1 Register Low	TREQR1L2	TREQR12	R
000981 _H	CAN2 - Transmission Request 1 Register High	TREQR1H2		R
000982 _H	CAN2 - Transmission Request 2 Register Low	TREQR2L2	TREQR22	R
000983 _H	CAN2 - Transmission Request 2 Register High	TREQR2H2		R
000984 _H - 00098F _H	Reserved			-
000990 _H	CAN2 - New Data 1 Register Low	NEWDT1L2	NEWDT12	R
000991 _H	CAN2 - New Data 1 Register High	NEWDT1H2		R
000992 _H	CAN2 - New Data 2 Register Low	NEWDT2L2	NEWDT22	R
000993 _H	CAN2 - New Data 2 Register High	NEWDT2H2		R
000994 _H - 00099F _H	Reserved			-
0009A0 _H	CAN2 - Interrupt Pending 1 Register Low	INTPND1L2	INTPND12	R
0009A1 _H	CAN2 - Interrupt Pending 1 Register High	INTPND1H2		R
0009A2 _H	CAN2 - Interrupt Pending 2 Register Low	INTPND2L2	INTPND22	R
0009A3 _H	CAN2 - Interrupt Pending 2 Register High	INTPND2H2		R
0009A4 _H - 0009AF _H	Reserved			-
0009B0 _H	CAN2 - Message Valid 1 Register Low	MSGVAL1L2	MSGVAL12	R
0009B1 _H	CAN2 - Message Valid 1 Register High	MSGVAL1H2		R
0009B2 _H	CAN2 - Message Valid 2 Register Low	MSGVAL2L2	MSGVAL22	R
0009B3 _H	CAN2 - Message Valid 2 Register High	MSGVAL2H2		R

I/O map CY96(F)315x (Sheet 22 of 22)

Address	Register	Abbreviation 8-bit access	Abbreviation 16-bit access	Access
0009B4 _H - 0009CD _H	Reserved			-
0009CE _H	CAN2 - Output enable register	COER2		R/W
0009CF _H - 000BFF _H	Reserved			-

Note: Any write access to reserved addresses in the I/O map should not be performed. A read access to a reserved address results in reading 'X'.

Registers of resources which are described in this table, but which are not supported by the device, should also be handled as "Reserved".

12. Interrupt Vector Table

Vector number	Offset in vector table	Vector name	Cleared by DMA	Index in ICR to program	Description
0	3FC _H	CALLV0	No	-	
1	3F8 _H	CALLV1	No	-	
2	3F4 _H	CALLV2	No	-	
3	3F0 _H	CALLV3	No	-	
4	3EC _H	CALLV4	No	-	
5	3E8 _H	CALLV5	No	-	
6	3E4 _H	CALLV6	No	-	
7	3E0 _H	CALLV7	No	-	
8	3DC _H	RESET	No	-	
9	3D8 _H	INT9	No	-	
10	3D4 _H	EXCEPTION	No	-	
11	3D0 _H	NMI	No	-	Non-Maskable Interrupt
12	3CC _H	DLY	No	12	Delayed Interrupt
13	3C8 _H	RC_TIMER	No	13	RC Timer
14	3C4 _H	MC_TIMER	No	14	Main Clock Timer
15	3C0 _H	SC_TIMER	No	15	Sub Clock Timer
16	3BC _H	PLL_UNLOCK	No	16	Reserved
17	3B8 _H	EXTINT0	Yes	17	External Interrupt 0
18	3B4 _H				Reserved
19	3B0 _H	EXTINT2	Yes	19	External Interrupt 2
20	3AC _H	EXTINT3	Yes	20	External Interrupt 3
21	3A8 _H	EXTINT4	Yes	21	External Interrupt 4
22	3A4 _H				Reserved
23	3A0 _H	EXTINT7	Yes	23	External Interrupt 7
24	39C _H	EXTINT8	Yes	24	External Interrupt 8
25	398 _H	EXTINT9	Yes	25	External Interrupt 9
26	394 _H	EXTINT10	Yes	26	External Interrupt 10
27	390 _H	EXTINT11	Yes	27	External Interrupt 11
28	38C _H	EXTINT12	Yes	28	External Interrupt 12
29	388 _H	EXTINT13	Yes	29	External Interrupt 13
30	384 _H				Reserved
31	380 _H				Reserved
32	37C _H				Reserved
33	378 _H	CAN2	No	33	CAN Controller 2
34	374 _H	PPG0	Yes	34	Programmable Pulse Generator 0
35	370 _H	PPG1	Yes	35	Programmable Pulse Generator 1

Vector number	Offset in vector table	Vector name	Cleared by DMA	Index in ICR to program	Description
36	36C _H				Reserved
37	368 _H	PPG3	Yes	37	Programmable Pulse Generator 3
38	364 _H	PPG4	Yes	38	Programmable Pulse Generator 4
39	360				Reserved
40	35C _H	PPG6	Yes	40	Programmable Pulse Generator 6
41	358 _H	PPG7	Yes	41	Programmable Pulse Generator 7
42	354 _H	PPG8	Yes	42	Programmable Pulse Generator 8
43	350 _H	PPG9	Yes	43	Programmable Pulse Generator 9
44	34C _H				Reserved
45	348 _H				Reserved
46	344 _H	PPG12	Yes	46	Programmable Pulse Generator 12
47	340 _H				Reserved
48	33C _H	PPG14	Yes	48	Programmable Pulse Generator 14
49	338 _H				Reserved
50	334 _H	PPG16	Yes	50	Programmable Pulse Generator 16
51	330 _H	PPG17	Yes	51	Programmable Pulse Generator 17
52	32C _H	PPG18	Yes	52	Programmable Pulse Generator 18
53	328 _H	PPG19	Yes	53	Programmable Pulse Generator 19
54	324 _H	RLT0	Yes	54	Reload Timer 0
55	320 _H	RLT1	Yes	55	Reload Timer 1
56	31C _H	RLT2	Yes	56	Reload Timer 2
57	318 _H	RLT3	Yes	57	Reload Timer 3
58	314 _H	PPGRLT	Yes	58	Reload Timer 6 - dedicated for PPG
59	310 _H	ICU0	Yes	59	Input Capture Unit 0
60	30C _H	ICU1	Yes	60	Input Capture Unit 1
61	308 _H				Reserved
62	304 _H				Reserved
63	300 _H	ICU4	Yes	63	Input Capture Unit 4
64	2FC _H	ICU5	Yes	64	Input Capture Unit 5
65	2F8 _H	ICU6	Yes	65	Input Capture Unit 6
66	2F4 _H				Reserved
67	2F0 _H				Reserved
68	2EC _H	ICU9	Yes	68	Input Capture Unit 9
69	2E8 _H	ICU10	Yes	69	Input Capture Unit 10
70	2E4 _H				Reserved
71	2E0 _H				Reserved
72	2DC _H				Reserved

Vector number	Offset in vector table	Vector name	Cleared by DMA	Index in ICR to program	Description
73	2D8 _H	OCU6	Yes	73	Output Compare Unit 6
74	2D4 _H	OCU7	Yes	74	Output Compare Unit 7
75	2D0 _H				Reserved
76	2CC _H				Reserved
77	2C8 _H	FRT0	Yes	77	Free Running Timer 0
78	2C4 _H	FRT1	Yes	78	Free Running Timer 1
79	2C0 _H	FRT2	Yes	79	Free Running Timer 2
80	2BC _H	FRT3	Yes	80	Free Running Timer 3
81	2B8 _H	RTC0	No	81	Real Timer Clock
82	2B4 _H	CAL0	No	82	Clock Calibration Unit
83	2B0 _H				Reserved
84	2AC _H	ADC0	Yes	84	A/D Converter
85	2A8 _H	LINR2	Yes	85	LIN USART 2 RX
86	2A4 _H	LINT2	Yes	86	LIN USART 2 TX
87	2A0 _H				Reserved
88	29C _H				Reserved
89	298 _H	LINR7	Yes	89	LIN USART 7 RX
90	294 _H	LINT7	Yes	90	LIN USART 7 TX
91	290 _H	LINR8	Yes	91	LIN USART 8 RX
92	28C _H	LINT8	Yes	92	LIN USART 8 TX
93	288 _H	FLASH_A	No	93	Flash memory A (only Flash devices)

13. Handling Devices

Special care is required for the following when handling the device:

- Latch-up prevention
- Unused pins handling
- External clock usage
- Unused sub clock signal
- Notes on PLL clock mode operation
- Power supply pins (V_{CC}/V_{SS})
- Crystal oscillator circuit
- Turn on sequence of power supply to A/D converter and analog inputs
- Pin handling when not using the A/D converter
- Notes on energization
- Stabilization of power supply voltage
- Serial communication

13.1 Latch-up prevention

CMOS IC chips may suffer latch-up under the following conditions:

- A voltage higher than V_{CC} or lower than V_{SS} is applied to an input or output pin.
- A voltage higher than the rated voltage is applied between V_{CC} pins and V_{SS} pins.

Latch-up may increase the power supply current dramatically, causing thermal damages to the device.

13.2 Unused pins handling

Unused input pins can be left open when the input is disabled (corresponding bit of Port Input Enable register PIER = 0).

Leaving unused input pins open when the input is enabled may result in misbehavior and possible permanent damage of the device. They must therefore be pulled up or pulled down through resistors. To prevent latch-up, those resistors should be more than $2\text{ k}\Omega$.

Unused bidirectional pins can be set either to the output state and be then left open, or to the input state with either input disabled or external pull-up/pull-down resistor as described above.

13.3 External clock usage

The permitted frequency range of an external clock depends on the oscillator type and configuration. See AC Characteristics for detailed modes and frequency limits. Single and opposite phase external clocks must be connected as follows:

1. Single phase external clock

- When using a single phase external clock, X0 (X0A) pin must be driven and X1 (X1A) pin left open.

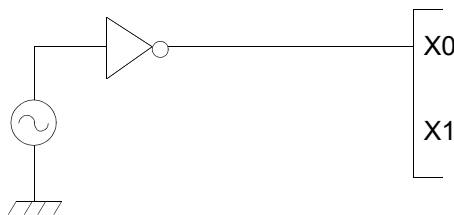

2. Opposite phase external clock

- When using an opposite phase external clock, X1 (X1A) must be supplied with a clock signal which has the opposite phase to the X0 (X0A) pins.

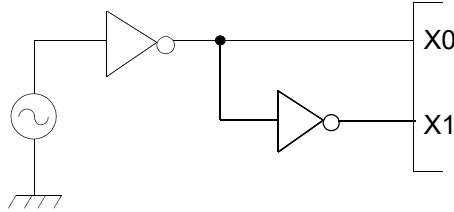

13.4 Unused sub clock signal

If the pins X0A and X1A are not connected to an oscillator, a pull-down resistor must be connected on the X0A pin and the X1A pin must be left open.

13.5 Notes on PLL clock mode operation

If the PLL clock mode is selected and no external oscillator is operating or no external clock is supplied, the microcontroller attempts to work with the free oscillating PLL. Performance of this operation, however, cannot be guaranteed.

13.6 Power supply pins (V_{CC}/V_{SS})

It is required that all V_{CC}-level as well as all V_{SS}-level power supply pins are at the same potential. If there is more than one V_{CC} or V_{SS} level, the device may operate incorrectly or be damaged even within the guaranteed operating range.

V_{CC} and V_{SS} must be connected to the device from the power supply with lowest possible impedance.

As a measure against power supply noise, it is required to connect a bypass capacitor of about 0.1 μF between V_{CC} and V_{SS} as close as possible to V_{CC} and V_{SS} pins.

13.7 Crystal oscillator and ceramic resonator circuit

Noise at X0, X1 pins or X0A, X1A pins might cause abnormal operation. It is required to provide bypass capacitors with shortest possible distance to X0, X1 pins and X0A, X1A pins, crystal oscillator (or ceramic resonator) and ground lines, and, to the utmost effort, that the lines of oscillation circuit do not cross the lines of other circuits.

It is highly recommended to provide a printed circuit board art work surrounding X0, X1 pins and X0A, X1A pins with a ground area for stabilizing the operation.

It is highly recommended to evaluate the quartz/MCU or resonator/MCU system at the quartz or resonator manufacturer, especially when using low-Q resonators at higher frequencies.

13.8 Turn on sequence of power supply to A/D converter and analog inputs

It is required to turn the A/D converter power supply (AV_{CC}, AVR_H, AVR_L) and analog inputs (AN_n) on after turning the digital power supply (V_{CC}) on.

It is also required to turn the digital power off after turning the A/D converter supply and analog inputs off. In this case, the voltage must not exceed AVR_H or AV_{CC} (turning the analog and digital power supplies simultaneously on or off is acceptable).

13.9 Pin handling when not using the A/D converter

It is required to connect the unused pins of the A/D converter as AV_{CC} = V_{CC}, AV_{SS} = AVR_H = AVR_L = V_{SS}.

13.10 Notes on Power-on

To prevent malfunction of the internal voltage regulator, supply voltage profile while turning the power supply on should be slower than 50 μs from 0.2 V to 2.7 V.

13.11 Stabilization of power supply voltage

If the power supply voltage varies acutely even within the operation safety range of the Vcc power supply voltage, a malfunction may occur. The Vcc power supply voltage must therefore be stabilized. As stabilization guidelines, the power supply voltage must be stabilized in such a way that Vcc ripple fluctuations (peak to peak value) in the commercial frequencies (50 to 60 Hz) fall within 10% of the standard Vcc power supply voltage and the transient fluctuation rate becomes 0.1V/μs or less in instantaneous fluctuation for power supply switching.

13.12 Serial communication

There is a possibility to receive wrong data due to noise or other causes on the serial communication.

Therefore, design a printed circuit board so as to avoid noise.

Consider receiving of wrong data when designing the system. For example apply a checksum and retransmit the data if an error occurs.

14. Electrical Characteristics

14.1 Absolute Maximum Ratings

Parameter	Symbol	Rating		Unit	Remarks
		Min	Max		
Power supply voltage	V_{CC}	$V_{SS} - 0.3$	$V_{SS} + 6.0$	V	
	AV_{CC}	$V_{SS} - 0.3$	$V_{SS} + 6.0$	V	$V_{CC} = AV_{CC}^{*1}$
AD Converter voltage references	AVRH, AVRL	$V_{SS} - 0.3$	$V_{SS} + 6.0$	V	$AV_{CC} \geq AVRH$, $AV_{CC} \geq AVRL$, $AVRH > AVRL$, $AVRL \geq AV_{SS}$
Input voltage	V_I	$V_{SS} - 0.3$	$V_{SS} + 6.0$	V	$V_I \leq V_{CC} + 0.3V^{*2}$
Output voltage	V_O	$V_{SS} - 0.3$	$V_{SS} + 6.0$	V	$V_O \leq V_{CC} + 0.3V^{*2}$
Maximum Clamp Current	I_{CLAMP}	-4.0	+4.0	mA	Applicable to general purpose I/O pins ^{*3}
Total Maximum Clamp Current	$\Sigma I_{CLAMP} $	-	40	mA	Applicable to general purpose I/O pins ^{*3}
"L" level maximum output current	I_{OL1}	-	15	mA	Normal outputs with driving strength set to 5mA
"L" level average output current	I_{OLAV1}	-	5	mA	Normal outputs with driving strength set to 5mA
"L" level maximum overall output current	ΣI_{OL1}	-	100	mA	Normal outputs
"L" level average overall output current	ΣI_{OLAV1}	-	50	mA	Normal outputs
"H" level maximum output current	I_{OH1}	-	-15	mA	Normal outputs with driving strength set to 5mA
"H" level average output current	I_{OHAV1}	-	-5	mA	Normal outputs with driving strength set to 5mA
"H" level maximum overall output current	ΣI_{OH1}	-	-100	mA	Normal outputs
"H" level average overall output current	ΣI_{OHAV1}	-	-50	mA	Normal outputs
Permitted Power dissipation (Flash devices) ^{*4}	P_D	-	220^{*5}	mW	$T_A = 105^\circ C$
		-	450^{*5}	mW	$T_A = 85^\circ C$
		-	615^{*5}	mW	$T_A = 70^\circ C$
		-	280^{*5}	mW	$T_A = 125^\circ C$, no Flash program/erase ^{*6}
		-	500^{*5}	mW	$T_A = 105^\circ C$, no Flash program/erase ^{*6}
Operating ambient temperature	T_A	0	+70	°C	CY96V300C
		-40	+105		
		-40	+125		^{*6}
Storage temperature	T_{STG}	-55	+150	°C	

- *1: AV_{CC} and V_{CC} must be set to the same voltage. It is required that AV_{CC} does not exceed V_{CC} and that the voltage at the analog inputs does not exceed AV_{CC} neither when the power is switched on.
- *2: V_I and V_O should not exceed $V_{CC} + 0.3$ V. V_I should also not exceed the specified ratings. However if the maximum current to/from an input is limited by some means with external components, the I_{CLAMP} rating supersedes the V_I rating. Input/output voltages of standard ports depend on V_{CC} .
- *3:
 - Applicable to all general purpose I/O pins (Pnn_m)
 - Use within recommended operating conditions.
 - Use at DC voltage (current)
 - The +B signal should always be applied a limiting resistance placed between the +B signal and the microcontroller.
 - The value of the limiting resistance should be set so that when the +B signal is applied the input current to the microcontroller pin does not exceed rated values, either instantaneously or for prolonged periods.
 - Note that when the microcontroller drive current is low, such as in the power saving modes, the +B input potential may pass through the protective diode and increase the potential at the V_{CC} pin, and this may affect other devices.
 - Note that if a +B signal is input when the microcontroller power supply is off (not fixed at 0 V), the power supply is provided from the pins, so that incomplete operation may result.
 - Note that if the +B input is applied during power-on, the power supply is provided from the pins and the resulting supply voltage may not be sufficient to operate the Power reset (except devices with persistent low voltage reset in internal vector mode).
 - Sample recommended circuits:

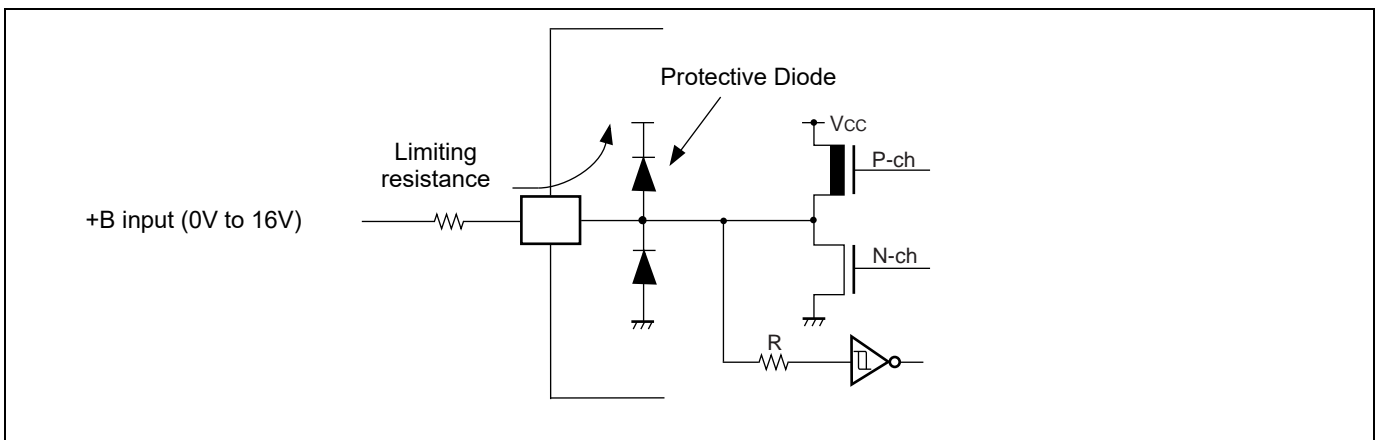

- *4: The maximum permitted power dissipation depends on the ambient temperature, the air flow velocity and the thermal conductance of the package on the PCB.
The actual power dissipation depends on the customer application and can be calculated as follows:
 $P_D = P_{IO} + P_{INT}$
 $P_{IO} = \sum (V_{OL} * I_{OL} + V_{OH} * I_{OH})$ (IO load power dissipation, sum is performed on all IO ports)
 $P_{INT} = V_{CC} * (I_{CC} + I_A)$ (internal power dissipation)
 I_{CC} is the total core current consumption into V_{CC} as described in the "3. DC characteristics" and depends on the selected operation mode and clock frequency and the usage of functions like Flash programming or the clock modulator.
 I_A is the analog current consumption into AV_{CC} .
- *5: Worst case value for a package mounted on single layer PCB at specified T_A without air flow.
- *6: Please contact Cypress for reliability limitations when using under these conditions.

WARNING: Semiconductor devices can be permanently damaged by application of stress (voltage, current, temperature, etc.) in excess of absolute maximum ratings. Do not exceed these ratings.

14.2 Recommended Operating Conditions

Parameter	Symbol	Value			Unit	Remarks
		Min	Typ	Max		
Power supply voltage	V_{CC}	3.0	-	5.5	V	
Smoothing capacitor at C pin	C_S	3.5	4.7	15	μF	Use a X7R ceramic capacitor or a capacitor that has similar frequency characteristics

WARNING: The recommended operating conditions are required in order to ensure the normal operation of the semiconductor device. All of the device's electrical characteristics are warranted when the device is operated within these ranges. Always use semiconductor devices within their recommended operating condition ranges. Operation outside these ranges may adversely affect reliability and could result in device failure. No warranty is made with respect to uses, operating conditions, or combinations not represented on the data sheet. Users considering application outside the listed conditions are advised to contact their representatives beforehand.

14.3 DC characteristics
 $(T_A = -40^\circ\text{C to } 125^\circ\text{C}, V_{CC} = AV_{CC} = 3.0\text{V to } 5.5\text{V}, V_{SS} = AV_{SS} = 0\text{V})$

Parameter	Symbol	Pin	Condition	Value			Unit	Remarks
				Min	Typ	Max		
Input H voltage	V_{IH}	Port inputs Pnn_m	CMOS Hysteresis 0.7/0.3 input selected	0.7 V_{CC}	-	$V_{CC} + 0.3$	V	$V_{CC} \geq 4.5\text{V}$
				0.74 V_{CC}	-	$V_{CC} + 0.3$	V	$V_{CC} < 4.5\text{V}$
			AUTOMOTIVE Hysteresis input selected	0.8 V_{CC}	-	$V_{CC} + 0.3$	V	
	V_{IH0F}	X0	External clock in "Fast Clock Input mode"	0.8 V_{CC}	-	$V_{CC} + 0.3$	V	
	V_{IH0S}	X0,X1, X0A,X1A	External clock in "oscillation mode"	2.5	-	$V_{CC} + 0.3$	V	
	V_{IHR}	RSTX	-	-	$V_{CC} + 0.3$	V	CMOS Hysteresis input	
	V_{IHM}	MD2-MD0	-	-	$V_{CC} + 0.3$	V		
Input L voltage	V_{IL}	Port inputs Pnn_m	CMOS Hysteresis 0.7/0.3 input selected	$V_{SS} - 0.3$	-	$0.3 V_{CC}$	V	
				$V_{SS} - 0.3$	-	$0.5 V_{CC}$	V	$V_{CC} \geq 4.5\text{V}$
			AUTOMOTIVE Hysteresis input selected	$V_{SS} - 0.3$	-	$0.46 V_{CC}$		$V_{CC} < 4.5\text{V}$
	V_{IL0F}	X0	External clock in "Fast Clock Input mode"	$V_{SS} - 0.3$	-	$0.2 V_{CC}$	V	
	V_{IL0S}	X0,X1, X0A,X1A	External clock in "oscillation mode"	$V_{SS} - 0.3$	-	0.4	V	
		V_{ILR}	RSTX	-	-	$0.2 V_{CC}$	V	CMOS Hysteresis input
	V_{ILM}	MD2-MD0	-	-	$V_{SS} + 0.3$	V		
Output H voltage	V_{OH2}	Normal outputs	$4.5\text{V} \leq V_{CC} \leq 5.5\text{V}$ $I_{OH} = -2\text{mA}$ $3.0\text{V} \leq V_{CC} < 4.5\text{V}$ $I_{OH} = -1.6\text{mA}$	$V_{CC} - 0.5$	-	-	V	Driving strength set to 2mA (PODR:OD=1)
	V_{OH5}	Normal outputs	$4.5\text{V} \leq V_{CC} \leq 5.5\text{V}$ $I_{OH} = -5\text{mA}$ $3.0\text{V} \leq V_{CC} < 4.5\text{V}$ $I_{OH} = -3\text{mA}$	$V_{CC} - 0.5$	-	-	V	Driving strength set to 5mA (PODR:OD=0)

(T_A = -40°C to 125°C, V_{CC} = AV_{CC} = 3.0V to 5.5V, V_{SS} = AV_{SS} = 0V)

Parameter	Symbol	Pin	Condition	Value			Unit	Remarks
				Min	Typ	Max		
Output L voltage	V _{OL2}	Normal outputs	4.5V ≤ V _{CC} ≤ 5.5V I _{OL} = +2mA	-	-	0.4	V	Driving strength set to 2mA (PODR:OD=1)
			3.0V ≤ V _{CC} < 4.5V I _{OL} = +1.6mA					
	V _{OL5}	Normal outputs	4.5V ≤ V _{CC} ≤ 5.5V I _{OL} = +5mA	-	-	0.4	V	
			3.0V ≤ V _{CC} < 4.5V I _{OL} = +3mA					
Input leak current	I _{IL}	Pnn_m	V _{SS} < V _I < V _{CC} AV _{SS} , AV _{RL} < V _I < AV _{CC} , AV _{RH}	-1	-	+1	μA	Single port pin
Pull-up resistance	R _{UP}	Pnn_m, RSTX	V _{CC} = 3.3V ± 10%	40	100	160	kΩ	
			V _{CC} = 5.0V ± 10%	25	50	100	kΩ	

(T_A = -40°C to 125°C, V_{CC} = AV_{CC} = 3.0V to 5.5V, V_{SS} = AV_{SS} = 0V)

Parameter	Symbol	Condition (at T _A)	Value		Unit	Remarks	
			Typ	Max			
Power supply current in Run modes*	I _{CCPLL}	PLL Run mode with CLKS1/2 = CLKB = CLKP1 = 16MHz, CLKP2 = 8MHz 1 Flash/ROM wait state (CLKRC and CLKSC stopped)	+25°C	14.5	19.5	mA	
			+125°C	16	23		
		PLL Run mode with CLKS1/2 = CLKB = CLKP1 = 32MHz, CLKP2 = 16MHz 2 Flash/ROM wait states (CLKRC and CLKSC stopped)	+25°C	23	29	mA	
			+125°C	25	33		
		PLL Run mode with CLKS1/2 = 48MHz, CLKB = CLKP1/2 = 24MHz 0 Flash/ROM wait states (CLKRC and CLKSC stopped)	+25°C	26	38	mA	
			+125°C	28	42		
		PLL Run mode with CLKS1/2 = CLKB = CLKP1 = 56MHz, CLKP2 = 28MHz 2 Flash/ROM wait states (CLKRC and CLKSC stopped. Core voltage at 1.9V)	+25°C	40	51	mA	
			+125°C	42	55		
		PLL Run mode with CLKS1/2 = 96MHz, CLKB = CLKP1 = 48MHz, CLKP2 = 24MHz 1 Flash/ROM wait state (CLKRC and CLKSC stopped. Core voltage at 1.9V)	+25°C	43	56	mA	
			+125°C	45	60		

($T_A = -40^{\circ}\text{C}$ to 125°C , $V_{CC} = AV_{CC} = 3.0\text{V}$ to 5.5V , $V_{SS} = AV_{SS} = 0\text{V}$)

Parameter	Symbol	Condition (at T_A)		Value		Unit	Remarks
				Typ	Max		
Power supply current in Run modes*	I_{CCMAIN}	Main Run mode with CLKS1/2 = CLKB = CLKP1/2 = 4MHz 1 Flash/ROM wait state (CLKPLL, CLKSC and CLKRC stopped)	+25°C	4	5	mA	
			+125°C	4.7	8		
	I_{CCRCH}	RC Run mode with CLKS1/2 = CLKB = CLKP1/2 = 2MHz 1 Flash/ROM wait state (CLKMC, CLKPLL and CLKSC stopped)	+25°C	2.5	3.5	mA	
			+125°C	3.2	6.5		
	I_{CCRCL}	RC Run mode with CLKS1/2 = CLKB = CLKP1/2 = 100kHz, SMCR:LPMS = 0 1 Flash/ROM wait state (CLKMC, CLKPLL and CLKSC stopped. Voltage regulator in high power mode)	+25°C	0.18	0.3	mA	
			+125°C	0.73	3.1		
		RC Run mode with CLKS1/2 = CLKB = CLKP1/2 = 100kHz, SMCR:LPMS = 1 1 Flash/ROM wait state (CLKMC, CLKPLL and CLKSC stopped. Voltage regulator in low power mode, no Flash programming/erasing allowed)	+25°C	0.15	0.25	mA	
			+125°C	0.7	3.05		
	I_{CCSUB}	Sub Run mode with CLKS1/2 = CLKB = CLKP1/2 = 32kHz 1 Flash/ROM wait state (CLKMC, CLKPLL and CLKRC stopped, no Flash programming/erasing allowed)	+25°C	0.1	0.2	mA	
			+125°C	0.65	3		

$(T_A = -40^{\circ}\text{C to } 125^{\circ}\text{C}, V_{CC} = AV_{CC} = 3.0\text{V to } 5.5\text{V}, V_{SS} = AV_{SS} = 0\text{V})$

Parameter	Symbol	Condition (at T_A)		Value		Unit	Remarks
				Typ	Max		
Power supply current in Sleep modes*	I_{CCSPLL}	PLL Sleep mode with CLKS1/2 = CLKP1 = 16MHz, CLKP2 = 8MHz (CLKRC and CLKSC stopped)	+25°C	4	6	mA	
			+125°C	4.7	9		
		PLL Sleep mode with CLKS1/2 = CLKP1 = 32MHz, CLKP2 = 16MHz (CLKRC and CLKSC stopped)	+25°C	7	9.5	mA	
			+125°C	8	12.5		
		PLL Sleep mode with CLKS1/2 = 48MHz, CLKP1/2 = 24MHz (CLKRC and CLKSC stopped)	+25°C	7	9	mA	
			+125°C	8	12		
	PLL Sleep mode with CLKS1/2 = CLKP1 = 56MHz, CLKP2 = 28MHz (CLKRC and CLKSC stopped. Core voltage at 1.9V)	+25°C	11	14.5	mA		
		+125°C	12	17.5			
	PLL Sleep mode with CLKS1/2 = 96MHz, CLKP1 = 48MHz, CLKP2 = 24MHz (CLKRC and CLKSC stopped. Core voltage at 1.9V)	+25°C	12	15	mA		
		+125°C	13	18			
	I_{CCSMAN}	Main Sleep mode with CLKS1/2 = CLKP1/2 = 4MHz (CLKPLL, CLKSC and CLKRC stopped)	+25°C	1	1.3	mA	
			+125°C	1.6	4.1		
I_{CCSRCH}	RC Sleep mode with CLKS1/2 = CLKP1/2 = 2MHz (CLKMC, CLKPLL and CLKSC stopped)	+25°C	0.55	1.1	mA		
		+125°C	1.15	3.9			
Power supply current in Sleep modes*	I_{CCSRCL}	RC Sleep mode with CLKS1/2 = CLKP1/2 = 100kHz, SMCR:LPMSS = 0 (CLKMC, CLKPLL and CLKSC stopped. Voltage regulator in high power mode)	+25°C	0.08	0.2	mA	
			+125°C	0.59	2.95		
		RC Sleep mode with CLKS1/2 = CLKP1/2 = 100kHz, SMCR:LPMSS = 1 (CLKMC, CLKPLL and CLKSC stopped. Voltage regulator in low power mode)	+25°C	0.05	0.15	mA	
			+125°C	0.56	2.9		
	I_{CCSSUB}	Sub Sleep mode with CLKS1/2 = CLKP1/2 = 32kHz (CLKMC, CLKPLL and CLKRC stopped)	+25°C	0.04	0.12	mA	
			+125°C	0.54	2.9		

($T_A = -40^{\circ}\text{C}$ to 125°C , $V_{CC} = AV_{CC} = 3.0\text{V}$ to 5.5V , $V_{SS} = AV_{SS} = 0\text{V}$)

Parameter	Symbol	Condition (at T_A)		Value		Unit	Remarks
				Typ	Max		
Power supply current in Timer modes*	I_{CCTPLL}	PLL Timer mode with CLKMC = 4MHz, CLKPLL = 48MHz (CLKRC and CLKSC stopped)	+25°C	1.3	1.8	mA	
			+125°C	1.9	4.8		
	$I_{CCTMAIN}$	Main Timer mode with CLKMC = 4MHz, SMCR:LPMSS = 0 (CLKPLL, CLKRC and CLKSC stopped. Voltage regulator in high power mode)	+25°C	0.11	0.2	mA	
			+125°C	0.63	3		
		Main Timer mode with CLKMC = 4MHz, SMCR:LPMSS = 1 (CLKPLL, CLKRC and CLKSC stopped. Voltage regulator in low power mode)	+25°C	0.08	0.15	mA	
			+125°C	0.6	2.9		
Power supply current in Timer modes*	I_{CCTRCH}	RC Timer mode with CLKRC = 2MHz, SMCR:LPMSS = 0 (CLKMC, CLKPLL and CLKSC stopped. Voltage regulator in high power mode)	+25°C	0.1	0.2	mA	
			+125°C	0.63	3		
		RC Timer mode with CLKRC = 2MHz, SMCR:LPMSS = 1 (CLKMC, CLKPLL and CLKSC stopped. Voltage regulator in low power mode)	+25°C	0.07	0.15	mA	
			+125°C	0.6	2.9		
	I_{CCTRCL}	RC Timer mode with CLKRC = 100kHz, SMCR:LPMSS = 0 (CLKMC, CLKPLL and CLKSC stopped. Voltage regulator in high power mode)	+25°C	0.06	0.15	mA	
			+125°C	0.56	2.95		
		RC Timer mode with CLKRC = 100kHz, SMCR:LPMSS = 1 (CLKMC, CLKPLL and CLKSC stopped. Voltage regulator in low power mode)	+25°C	0.03	0.1	mA	
			+125°C	0.53	2.85		
	I_{CCTSUB}	Sub Timer mode with CLKSC = 32kHz (CLKMC, CLKPLL and CLKRC stopped)	+25°C	0.035	0.1	mA	
			+125°C	0.53	2.85		

($T_A = -40^\circ\text{C}$ to 125°C , $V_{CC} = AV_{CC} = 3.0\text{V}$ to 5.5V , $V_{SS} = AV_{SS} = 0\text{V}$)

Parameter	Symbol	Condition (at T_A)		Value		Unit	Remarks
				Typ	Max		
Power supply current in Stop Mode	I_{CCH}	VRCR:LPMB[2:0] = 110 _B (Core voltage at 1.8V)	+25°C	0.02	0.08	mA	
			+125°C	0.52	2.8		
		VRCR:LPMB[2:0] = 000 _B (Core voltage at 1.2V)	+25°C	0.015	0.06	mA	
			+125°C	0.4	2.3		
Power supply current for active Low Voltage detector	I_{CCLVD}	Low voltage detector enabled (RCR:LVDE = 1)	+25°C	5	10	μA	Must be added to all current above
			+125°C	7	20		
Power supply current for active Clock modulator	$I_{CCCLOMO}$	Clock modulator enabled (CM-CR:PDX = 1)	-	3	4.5	mA	Must be added to all current above
Flash Write/Erase current	$I_{CCFLASH}$	Current for one Flash module	-	15	40	mA	Must be added to all current above
Input capacitance	C_{IN}	-	-	5	15	pF	Other than C, AV_{CC} , AV_{SS} , $AVRH$, $AVRL$, V_{CC} , V_{SS}

* : The power supply current is measured with a 4MHz external clock connected to the Main oscillator and a 32kHz external clock connected to the Sub oscillator. See chapter "Standby mode and voltage regulator control" of the Hardware Manual for further details about voltage regulator control.

14.4 AC Characteristics
Source Clock timing

 ($T_A = -40^{\circ}\text{C}$ to 125°C , $V_{CC} = AV_{CC} = 3.0\text{V}$ to 5.5V , $V_{SS} = AV_{SS} = 0\text{V}$)

Parameter	Symbol	Pin	Value			Unit	Remarks
			Min	Typ	Max		
Clock frequency	f_C	X0, X1	3	-	16	MHz	When using a crystal oscillator, PLL off
			0	-	16	MHz	When using an opposite phase external clock, PLL off
			3.5	-	16	MHz	When using a crystal oscillator or opposite phase external clock, PLL on
Clock frequency	f_{FCI}	X0	0	-	56	MHz	When using a single phase external clock in "Fast Clock Input mode", PLL off
			3.5	-	56	MHz	When using a single phase external clock in "Fast Clock Input mode", PLL on
Clock frequency	f_{CL}	X0A, X1A	32	32.768	100	kHz	When using an oscillation circuit
			0	-	100	kHz	When using an opposite phase external clock
		X0A	0	-	50	kHz	When using a single phase external clock
Clock frequency	f_{CR}	-	50	100	200	kHz	When using slow frequency of RC oscillator
			1	2	4	MHz	When using fast frequency of RC oscillator
RC clock stabilization time	t_{RCSTAB}	-	256 RC clock cycles				Applied after any reset and when activating the RC oscillator.
PLL Clock frequency	f_{CLKVCO}	-	64	-	200	MHz	Permitted VCO output frequency of PLL (CLKVCO)
PLL Phase Jitter	T_{PSKEW}	-	-	-	± 5	ns	For CLKMC (PLL input clock) \square 4MHz, jitter coming from external oscillator, crystal or resonator is not covered
Input clock pulse width	P_{WH}, P_{WL}	X0,X1	8	-	-	ns	Duty ratio is about 30% to 70%
Input clock pulse width	P_{WHL}, P_{WLL}	X0A,X1A	5	-	-	μs	

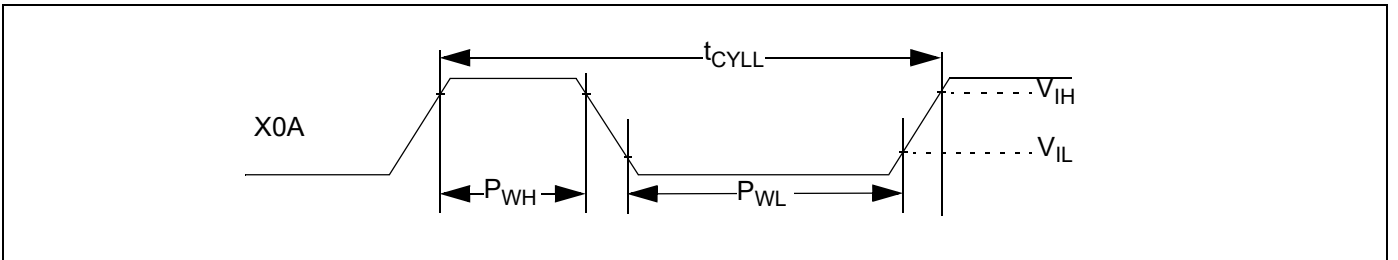
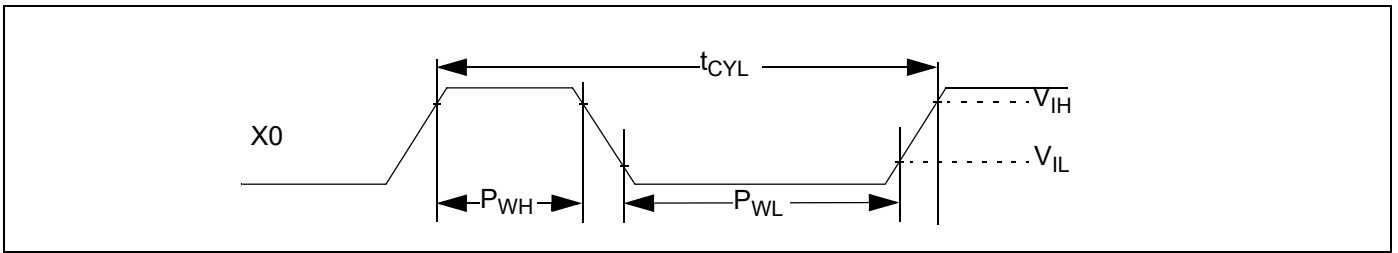

Internal Clock timing

($T_A = -40^{\circ}\text{C}$ to 125°C , $V_{CC} = AV_{CC} = 3.0\text{V}$ to 5.5V , $V_{SS} = AV_{SS} = 0\text{V}$)

Parameter	Symbol	Core Voltage Settings				Unit	Remarks
		1.8V		1.9V			
		Min	Max	Min	Max		
Internal System clock frequency (CLKS1 and CLKS2)	$f_{\text{CLKS1}}, f_{\text{CLKS2}}$	0	92	0	96	MHz	
Internal CPU clock frequency (CLKB), internal peripheral clock frequency (CLKP1)	$f_{\text{CLKB}}, f_{\text{CLKP1}}$	0	52	0	56	MHz	
Internal peripheral clock frequency (CLKP2)	f_{CLKP2}	0	28	0	32	MHz	

External Reset timing

($T_A = -40^{\circ}\text{C}$ to 125°C , $V_{CC} = AV_{CC} = 3.0\text{V}$ to 5.5V , $V_{SS} = AV_{SS} = 0\text{V}$)

Parameter	Symbol	Pin	Value			Unit	Remarks
			Min	Typ	Max		
Reset input time	t_{RSTL}	RSTX	500	-	-	ns	

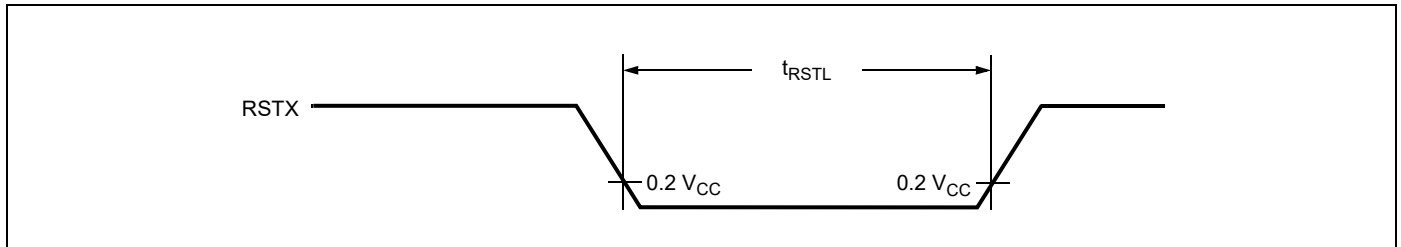

Power On Reset timing

($T_A = -40^\circ\text{C}$ to 125°C , $V_{CC} = AV_{CC} = 3.0\text{V}$ to 5.5V , $V_{SS} = AV_{SS} = 0\text{V}$)

Parameter	Symbol	Pin	Value			Unit	Remarks
			Min	Typ	Max		
Power on rise time	t_R	Vcc	0.05	-	30	ms	
Power off time	t_{OFF}	Vcc	1	-	-	ms	

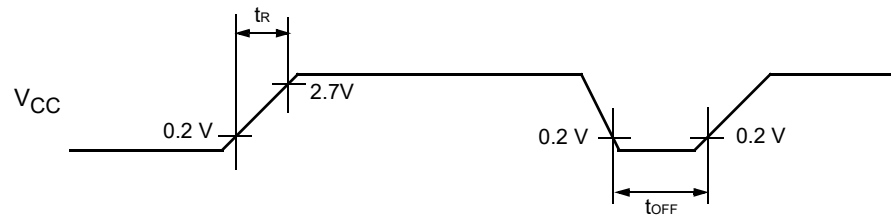

If the power supply is changed too rapidly, a power-on reset may occur. We recommend a smooth startup by restraining voltages when changing the power supply voltage during operation, as shown in the figure below.



External Input timing

($T_A = -40^{\circ}\text{C}$ to 125°C , $V_{CC} = AV_{CC} = 3.0\text{V}$ to 5.5V , $V_{SS} = AV_{SS} = 0\text{V}$)

Parameter	Symbol	Pin	Condition	Value		Unit	Used Pin input function
				Min	Max		
Input pulse width	t_{INH} t_{INL}	INTn(_R)	—	200	—	ns	External Interrupt
		NMI					NMI
		Pnn_m		$2 * t_{CLKP1} + 200$ ($t_{CLKP1} = 1/f_{CLKP1}$)	—	ns	General Purpose IO
		TINn					Reload Timer
		TTGn(_R)					PPG Trigger input
		ADTG_R					AD Converter Trigger
		INn					Input Capture

Note : Relocated Resource Inputs have same characteristics

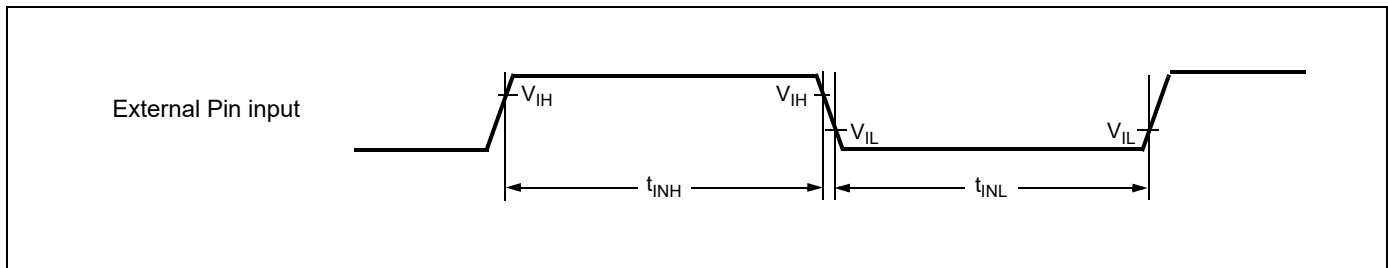

USART timing

WARNING: The values given below are for an I/O driving strength $IO_{drive} = 5mA$. If IO_{drive} is 2mA, all the maximum output timing described in the different tables must then be increased by 10ns.

($T_A = -40^{\circ}C$ to $125^{\circ}C$, $V_{CC} = 3.0V$ to $5.5V$, $V_{SS} = AV_{SS} = 0V$, $IO_{drive} = 5mA$, $C_L = 50pF$)

Parameter	Symbol	Pin	Condition	$V_{CC} = AV_{CC} = 4.5V$ to $5.5V$		$V_{CC} = AV_{CC} = 3.0V$ to $4.5V$		Unit
				Min	Max	Min	Max	
Serial clock cycle time	t_{SCYCI}	SCKn	Internal Shift Clock Mode	$4 t_{CLKP1}$	—	$4 t_{CLKP1}$	—	ns
SCK ↓ → SOT delay time	t_{SLOVI}	SCKn, SOTn		-20	+20	-30	+30	ns
SOT → SCK ↑ delay time	t_{OVSHI}	SCKn, SOTn		$N * t_{CLKP1} - 20$	—	$N * t_{CLKP1} - 30$	—	ns
Valid SIN → SCK ↑	t_{IVSHI}	SCKn, SINn		$t_{CLKP1} + 45$	—	$t_{CLKP1} + 55$	—	ns
SCK ↑ → Valid SIN hold time	t_{SHIXI}	SCKn, SINn		0	—	0	—	ns
Serial clock "L" pulse width	t_{SLSHE}	SCKn	External Shift Clock Mode	$t_{CLKP1} + 10$	—	$t_{CLKP1} + 10$	—	ns
Serial clock "H" pulse width	t_{SHSLE}	SCKn		$t_{CLKP1} + 10$	—	$t_{CLKP1} + 10$	—	ns
SCK ↓ → SOT delay time	t_{SLOVE}	SCKn, SOTn		—	$2 t_{CLKP1} + 45$	—	$2 t_{CLKP1} + 55$	ns
Valid SIN → SCK ↑	t_{IVSHE}	SCKn, SINn		$t_{CLKP1}/2 + 10$	—	$t_{CLKP1}/2 + 10$	—	ns
SCK ↑ → Valid SIN hold time	t_{SHIXE}	SCKn, SINn		$t_{CLKP1} + 10$	—	$t_{CLKP1} + 10$	—	ns
SCK fall time	t_{FE}	SCKn		—	20	—	20	ns
SCK rise time	t_{RE}	SCKn		—	20	—	20	ns

- Notes:
- AC characteristic in CLK synchronized mode.
 - C_L is the load capacity value of pins when testing.
 - Depending on the used machine clock frequency, the maximum possible baud rate can be limited by some parameters. These parameters are shown in "CY96300 Super series Hardware Manual".
 - t_{CLKP1} is the cycle time of the peripheral clock 1 (CLKP1), Unit : ns

*1: Parameter N depends on t_{SCYCI} and can be calculated as follows:

- if $t_{SCYCI} = 2 * k * t_{CLKP1}$, then $N = k$, where k is an integer > 2
- if $t_{SCYCI} = (2 * k + 1) * t_{CLKP1}$, then $N = k + 1$, where k is an integer > 1

Examples:

t_{scyci}	N
$4 * t_{CLKP1}$	2
$5 * t_{CLKP1}, 6 * t_{CLKP1}$	3
$7 * t_{CLKP1}, 8 * t_{CLKP1}$	4
...	...

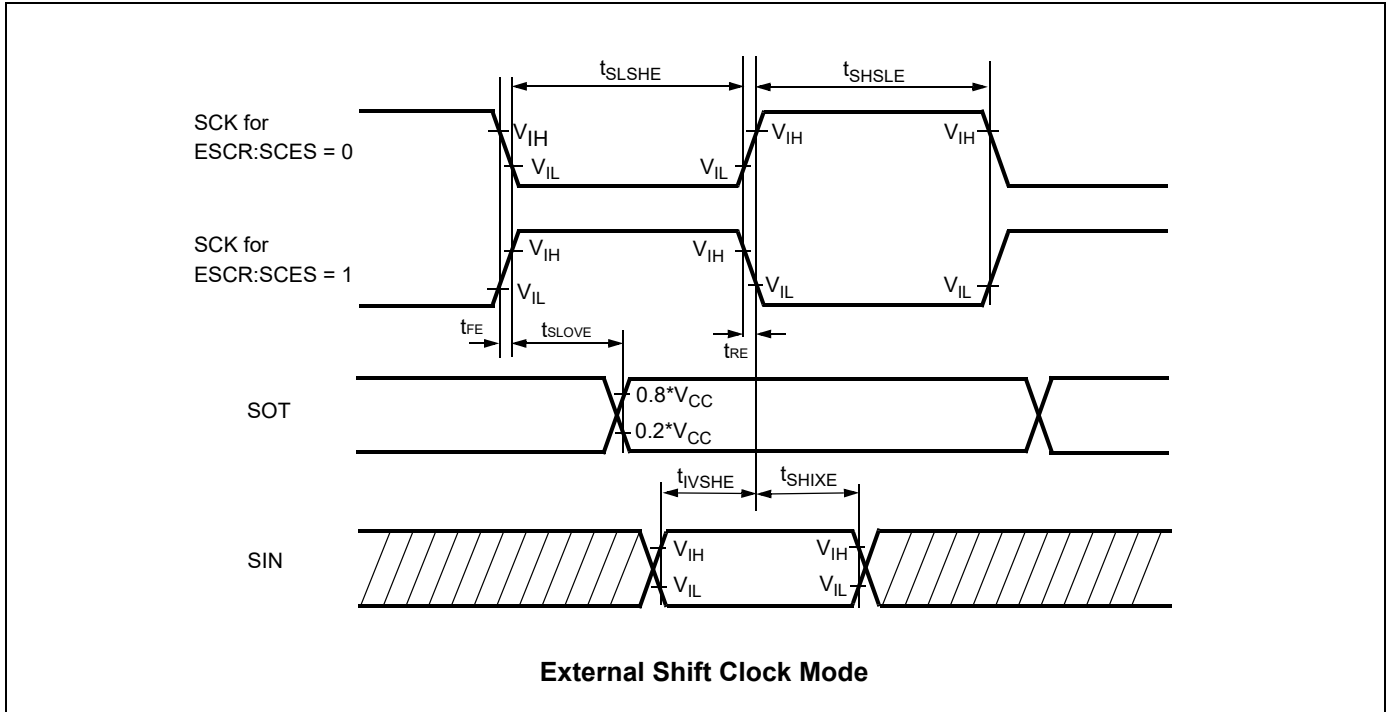
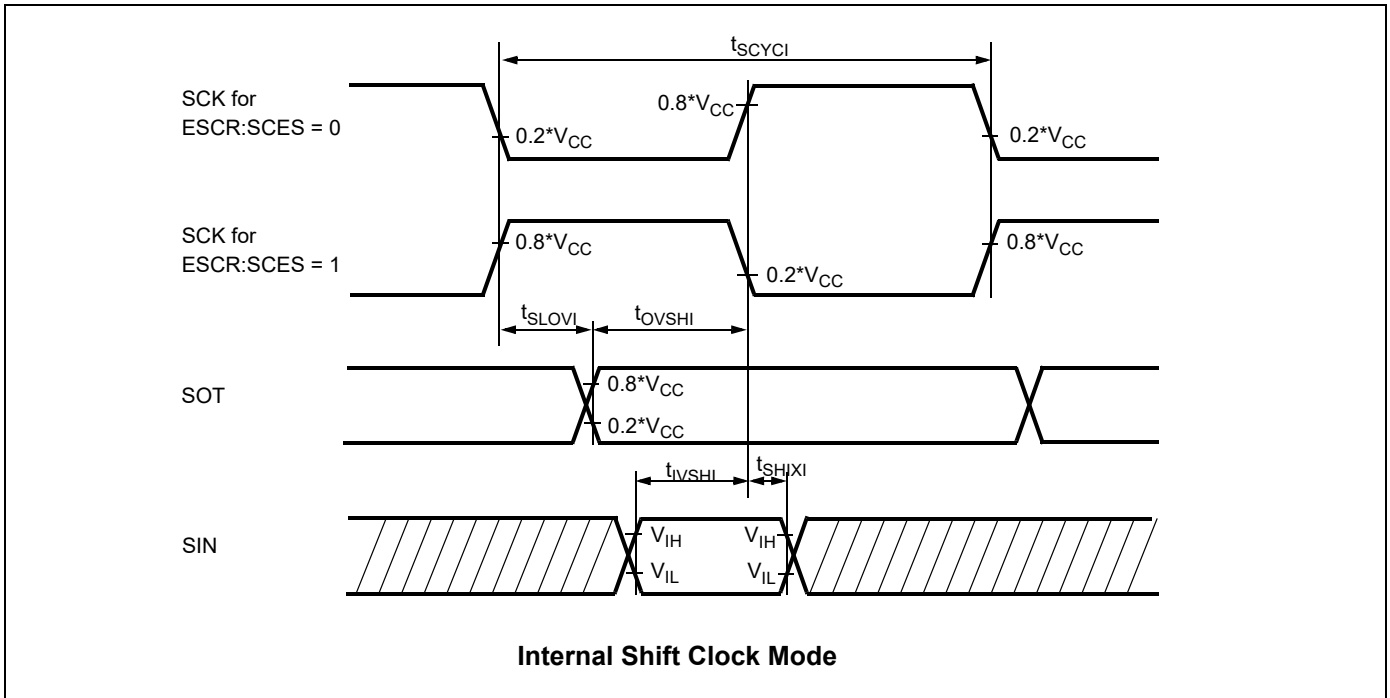

14.5 Analog Digital Converter
 $(T_A = -40\text{ }^\circ\text{C to } +125\text{ }^\circ\text{C}, 3.0\text{ V} \leq \text{AVRH} - \text{AVRL}, V_{CC} = \text{AV}_{CC} = 3.0\text{V to } 5.5\text{V}, V_{SS} = \text{AV}_{SS} = 0\text{V})$

Parameter	Symbol	Pin	Value			Unit	Remarks
			Min	Typ	Max		
Resolution	-	-	-	-	10	bit	
Total error	-	-	-	-	± 3	LSB	
Nonlinearity error	-	-	-	-	± 2.5	LSB	
Differential nonlinearity error	-	-	-	-	± 1.9	LSB	
Zero transition voltage	V_{OT}	ANn	AVRL - 1.5 LSB	AVRL + 0.5 LSB	AVRL + 2.5 LSB	V	
Full scale transition voltage	V_{FST}	ANn	AVRH - 3.5 LSB	AVRH - 1.5 LSB	AVRH + 0.5 LSB	V	
Compare time	-	-	1.0	-	16,500	μs	$4.5\text{V} \leq \text{AV}_{CC} \leq 5.5\text{V}$
			2.0	-	-	μs	$3.0\text{V} \leq \text{AV}_{CC} < 4.5\text{V}$
Sampling time	-	-	0.5	-	-	μs	$4.5\text{V} \leq \text{AV}_{CC} \leq 5.5\text{V}$
			1.2	-	-	μs	$3.0\text{V} \leq \text{AV}_{CC} < 4.5\text{V}$
Analog input leakage current (during conversion)	I_{AIN}	ANn	-1	-	+1	μA	$T_A \leq 105\text{ }^\circ\text{C}$, $\text{AV}_{SS}, \text{AVRL} < V_I < \text{AV}_{CC}$, AVRH
			-1.2	-	+1.2	μA	$105\text{ }^\circ\text{C} < T_A \leq 125\text{ }^\circ\text{C}$, $\text{AV}_{SS}, \text{AVRL} < V_I < \text{AV}_{CC}$, AVRH
Analog input voltage range	V_{AIN}	ANn	AVRL	-	AVRH	V	
Reference voltage range	AVRH	AVRH	0.75AV_{CC}	-	AV_{CC}	V	
	AVRL	AVRL	AV_{SS}	-	0.25AV_{CC}	V	
Power supply current	I_A	AV_{CC}	-	2.5	5	mA	A/D Converter active
	I_{AH}	AV_{CC}	-	-	5	μA	A/D Converter not operated
Reference voltage current	I_R	AVRH/AVR _L	-	0.7	1	mA	A/D Converter active
	I_{RH}	AVRH/AVR _L	-	-	5	μA	A/D Converter not operated
Offset between input channels	-	ANn	-	-	4	LSB	

Note: The accuracy gets worse as $|\text{AVRH} - \text{AVRL}|$ becomes smaller.

Definition of A/D Converter Terms

Resolution: Analog variation that is recognized by an A/D converter.

Total error: Difference between the actual value and the ideal value. The total error includes zero transition error, full-scale transition error and nonlinearity error.

Nonlinearity error: Deviation between a line across zero-transition line (“00 0000 0000” <--> “00 0000 0001”) and full-scale transition line (“11 1111 1110” <--> “11 1111 1111”) and actual conversion characteristics.

Differential nonlinearity error: Deviation of input voltage, which is required for changing output code by 1 LSB, from an ideal value.

Zero reading voltage: Input voltage which results in the minimum conversion value.

Full scale reading voltage: Input voltage which results in the maximum conversion value.

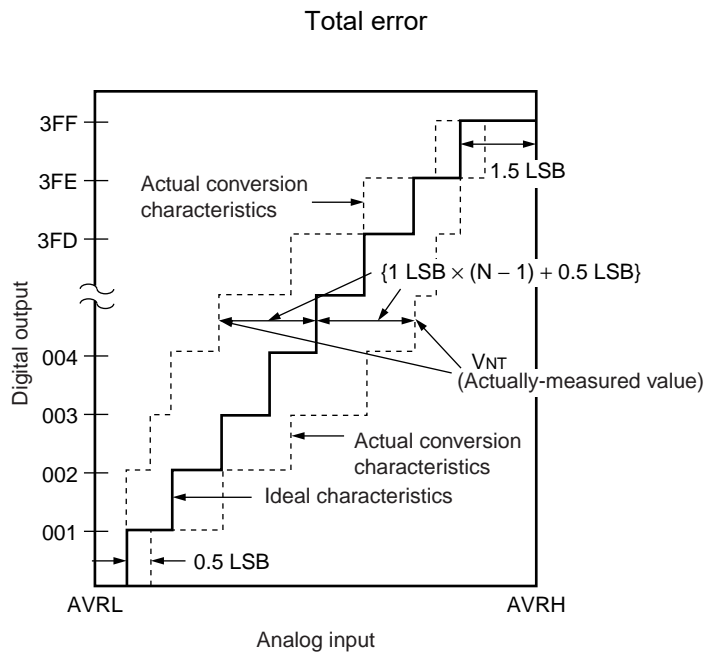

$$\text{Total error of digital output "N"} = \frac{V_{NT} - \{1 \text{ LSB} \times (N - 1) + 0.5 \text{ LSB}\}}{1 \text{ LSB}} \text{ [LSB]}$$

$$1 \text{ LSB} = (\text{Ideal value}) \frac{AVRH - AVRL}{1024} \text{ [V]}$$

N: A/D converter digital output value

$$V_{OT} (\text{Ideal value}) = AVRL + 0.5 \text{ LSB [V]}$$

$$V_{FST} (\text{Ideal value}) = AVRH - 1.5 \text{ LSB [V]}$$

V_{NT} : A voltage at which digital output transitions from (N - 1) to N.

Nonlinearity error

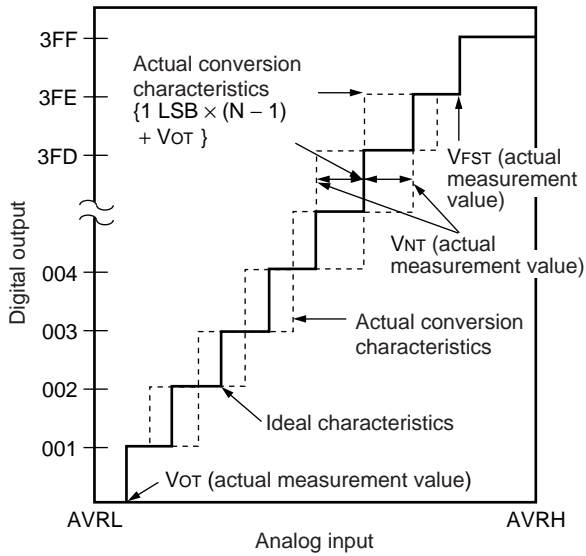

Differential nonlinearity error

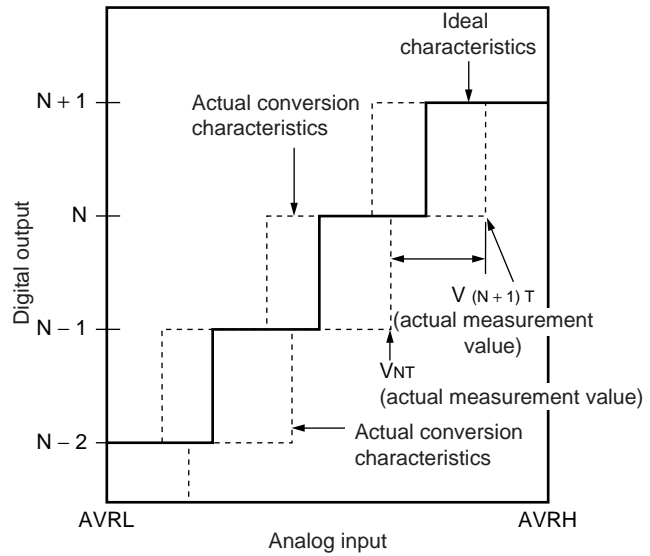

$$\text{Nonlinearity error of digital output } N = \frac{V_{NT} - \{1 \text{ LSB} \times (N - 1) + V_{OT}\}}{1 \text{ LSB}} \text{ [LSB]}$$

$$\text{Differential nonlinearity error of digital output } N = \frac{V_{(N+1)T} - V_{NT}}{1 \text{ LSB}} - 1 \text{ LSB [LSB]}$$

$$1 \text{ LSB} = \frac{V_{FST} - V_{OT}}{1022} \text{ [V]}$$

N : A/D converter digital output value

V_{OT} : Voltage at which digital output transits from “000_H” to “001_H.”

V_{FST} : Voltage at which digital output transits from “3FE_H” to “3FF_H.”

Accuracy and setting of the A/D Converter sampling time

If the external impedance is too high or the sampling time too short, the analog voltage charged to the internal sample and hold capacitor is insufficient, adversely affecting the A/D conversion precision.

To satisfy the A/D conversion precision, a sufficient sampling time must be selected. The required sampling time depends on the external driving impedance R_{ext} , the board capacitance of the A/D converter input pin C_{ext} and the AV_{CC} voltage level. The following replacement model can be used for the calculation:

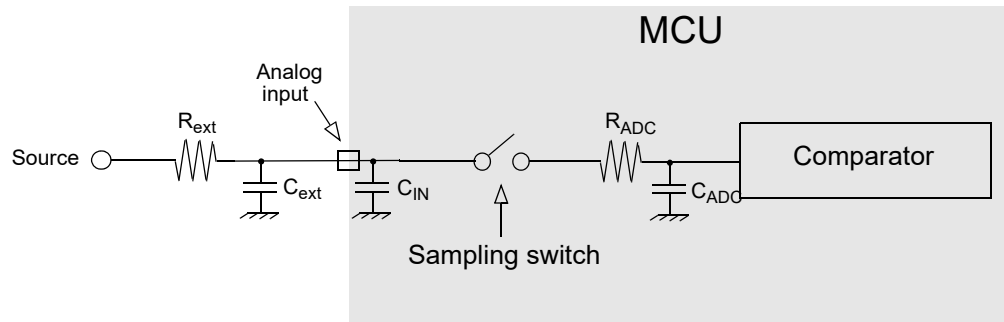

- R_{ext} : external driving impedance
- C_{ext} : capacitance of PCB at A/D converter input
- C_{IN} : capacitance of MCU input pin: 15pF (max)
- R_{ADC} : resistance within MCU: 2.6k Ω (max) for $4.5V \leq AV_{CC} \leq 5.5V$
12k Ω (max) for $3.0V \leq AV_{CC} < 4.5V$
- C_{ADC} : sampling capacitance within MCU: 10pF (max)

The sampling time should be set to minimum “7 τ “. The following approximation formula for the replacement model above can be used:

$$T_{s\text{amp}} [\text{min}] = 7 \times (R_{ext} \times (C_{ext} + C_{IN}) + (R_{ext} + R_{ADC}) \times C_{ADC})$$

- Do not select a sampling time below the absolute minimum permitted value (0.5 μs for $4.5V \leq AV_{CC} \leq 5.5V$; 1.2 μs for $3.0V \leq AV_{CC} < 4.5V$).
- If the sampling time cannot be sufficient, connect a capacitor of about 0.1 μF to the analog input pin. In this case the internal sampling capacitance C_{ADC} will be charged out of this external capacitance.
- A big external driving impedance also adversely affects the A/D conversion precision due to the pin input leakage current I_{IL} (static current before the sampling switch) or the analog input leakage current I_{AIN} (total leakage current of pin input and comparator during sampling). The effect of the pin input leakage current I_{IL} cannot be compensated by an external capacitor.
- The accuracy gets worse as $|AVRH - AVRL|$ becomes smaller.

14.6 Low Voltage Detector characteristics

($T_A = -40\text{ }^\circ\text{C}$ to $+125\text{ }^\circ\text{C}$, $V_{CC} = AV_{CC} = 3.0\text{V} - 5.5\text{V}$, $V_{SS} = AV_{SS} = 0\text{V}$)

Parameter	Symbol	Value		Unit	Remarks
		Min	Max		
Stabilization time	$T_{LVDSTAB}$	-	110	μs	After power-up or change of detection level
Level 0	V_{DL0}	2.5	2.9	V	CILCR:LVL[3:0]="0000"
Level 1	V_{DL1}	2.8	3.2	V	CILCR:LVL[3:0]="0001"
Level 2	V_{DL2}	3	3.4	V	CILCR:LVL[3:0]="0010"
Level 3	V_{DL3}	3.35	3.8	V	CILCR:LVL[3:0]="0011"
Level 4	V_{DL4}	3.5	3.95	V	CILCR:LVL[3:0]="0100"
Level 5	V_{DL5}	3.6	4.1	V	CILCR:LVL[3:0]="0101"
Level 6	V_{DL6}	3.7	4.2	V	CILCR:LVL[3:0]="0110"
Level 7	V_{DL7}	3.8	4.3	V	CILCR:LVL[3:0]="0111"
Level 8	V_{DL8}	3.9	4.4	V	CILCR:LVL[3:0]="1000"
Level 9	V_{DL9}	3.95	4.5	V	CILCR:LVL[3:0]="1001"
Level 10	V_{DL10}	not used			
Level 11	V_{DL11}	not used			
Level 12	V_{DL12}	2.6	3	V	CILCR:LVL[3:0]="1100"
Level 13	V_{DL13}	not used			
Level 14	V_{DL14}	not used			
Level 15	V_{DL15}	not used			

CILCR:LVL[3:0] are the low voltage detector level select bits of the CILCR register.

For correct detection, the slope of the voltage level must satisfy $\left| \frac{dV}{dt} \right| \leq 0.004 \frac{\text{V}}{\mu\text{s}}$.

Faster variations are regarded as noise and may not be detected.

The functional operation of the MCU is guaranteed down to the minimum low voltage detection level of "Level 0" (V_{DL0_MIN}). The electrical characteristics however are only valid in the specified range (usually down to 3.0V).

Low Voltage Detector Operation

In the following figure, the occurrence of a low voltage condition is illustrated. For a detailed description of the reset and startup behavior, please refer to the corresponding hardware manual chapter.

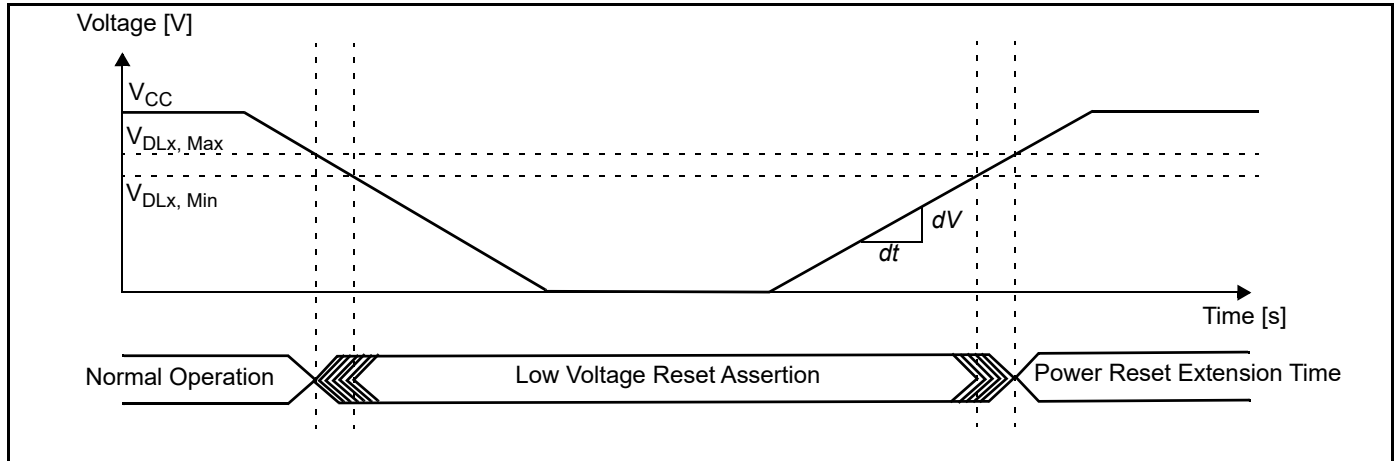

14.7 FLASH memory program/erase characteristics

($T_A = -40^{\circ}\text{C}$ to 105°C , $V_{CC} = AV_{CC} = 3.0\text{V}$ to 5.5V , $V_{SS} = AV_{SS} = 0\text{V}$)

Parameter	Value			Unit	Remarks
	Min	Typ	Max		
Sector erase time	-	0.9	3.6	s	Without erasure pre-programming time
Chip erase time	-	n*0.9	n*3.6	s	Without erasure pre-programming time (n is the number of Flash sector of the device)
Word (16-bit width) programming time	-	23	370	us	Without overhead time for submitting write command
Program/Erase cycle	10000	-	-	cycle	
Flash data retention time	20	-	-	year	*1

*1: This value was converted from the results of evaluating the reliability of the technology (using Arrhenius equation to convert high temperature measurements into normalized value at 85°C)

15. Example Characteristics

15.1 Temperature dependency of power supply currents

The following diagrams show the current consumption of samples with typical wafer process parameters in different operation modes.

Common condition for all operation modes:

- $V_{CC} = AV_{CC} = 5.0V$
- Main clock = 4MHz external clock
- Sub clock = 32kHz external clock

Operation mode details:

Mode name	Details
PLL Run 56	PLL Run mode current I_{CCPLL} with the following settings: <ul style="list-style-type: none"> • $f_{CLKS1} = f_{CLKS2} = f_{CLKB} = f_{CLKP1} = 56MHz$ • $f_{CLKP2} = 28MHz$ • Regulator in High Power Mode • Core voltage at 1.9V (VRCR:HPM[1:0] = 11_B) • 2 Flash/ROM wait states (MTCRA=233A_H) • RC oscillator and Sub oscillator stopped
PLL Run 48	PLL Run mode current I_{CCPLL} with the following settings: <ul style="list-style-type: none"> • $f_{CLKS1} = f_{CLKS2} = 96MHz$ • $f_{CLKB} = f_{CLKP1} = 48MHz$ • $f_{CLKP2} = 24MHz$ • Regulator in High Power Mode • Core voltage at 1.9V (VRCR:HPM[1:0] = 11_B) • 1 Flash/ROM wait states (MTCRA=6B09_H) • RC oscillator and Sub oscillator stopped
PLL Run 24	PLL Run mode current I_{CCPLL} with the following settings: <ul style="list-style-type: none"> • $f_{CLKS1} = f_{CLKS2} = 48MHz$ • $f_{CLKB} = f_{CLKP1} = f_{CLKP2} = 24MHz$ • Regulator in High Power Mode • Core voltage at 1.8V (VRCR:HPM[1:0] = 10_B) • 0 Flash/ROM wait states (MTCRA=2208_H) • RC oscillator and Sub oscillator stopped
Main Run	Main Run mode current I_{CCMAIN} with the following settings: <ul style="list-style-type: none"> • $f_{CLKS1} = f_{CLKS2} = f_{CLKB} = f_{CLKP1} = f_{CLKP2} = 4MHz$ • Regulator in High Power Mode • Core voltage at 1.8V (VRCR:HPM[1:0] = 10_B) • 1 Flash/ROM wait states (MTCRA=0239_H) • PLL, RC oscillator and Sub oscillator stopped
RC Run 2M	RC Run mode current I_{CCRCH} with the following settings: <ul style="list-style-type: none"> • RC oscillator set to 2MHz (CKFCR:RCFS = 1) • $f_{CLKS1} = f_{CLKS2} = f_{CLKB} = f_{CLKP1} = f_{CLKP2} = 2MHz$ • Regulator in High Power Mode • Core voltage at 1.8V (VRCR:HPM[1:0] = 10_B) • 1 Flash/ROM wait states (MTCRA=0239_H) • PLL, Main oscillator and Sub oscillator stopped

Mode name	Details
RC Run 100k	RC Run mode current I_{CCRCL} with the following settings: <ul style="list-style-type: none"> • RC oscillator set to 100kHz (CKFCR:RCFS = 0) • $f_{CLKS1} = f_{CLKS2} = f_{CLKB} = f_{CLKP1} = f_{CLKP2} = 100kHz$ • Regulator in Low Power Mode A (SMCR:LPMS = 1) • Core voltage at 1.8V (VRCR:LPMA[2:0] = 110_B) • 1 Flash/ROM wait states (MTCRA=0239_H) • PLL, Main oscillator and Sub oscillator stopped
Sub Run	Sub Run mode current I_{CCSUB} with the following settings: <ul style="list-style-type: none"> • $f_{CLKS1} = f_{CLKS2} = f_{CLKB} = f_{CLKP1} = f_{CLKP2} = 32kHz$ • Regulator in Low Power Mode A (by hardware) • Core voltage at 1.8V (VRCR:LPMA[2:0] = 110_B) • 1 Flash/ROM wait states (MTCRA=0239_H) • PLL, RC oscillator and Main oscillator stopped
PLL Sleep 56	PLL Sleep mode current I_{CCSPLL} with the following settings: <ul style="list-style-type: none"> • $f_{CLKS1} = f_{CLKS2} = f_{CLKP1} = 56MHz$ • $f_{CLKP2} = 28MHz$ • Regulator in High Power Mode • Core voltage at 1.9V (VRCR:HPM[1:0] = 11_B) • RC oscillator and Sub oscillator stopped
PLL Sleep 48	PLL Sleep mode current I_{CCSPLL} with the following settings: <ul style="list-style-type: none"> • $f_{CLKS1} = f_{CLKS2} = 96MHz$ • $f_{CLKP1} = 48MHz$ • $f_{CLKP2} = 24MHz$ • Regulator in High Power Mode • Core voltage at 1.9V (VRCR:HPM[1:0] = 11_B) • RC oscillator and Sub oscillator stopped
PLL Sleep 24	PLL Sleep mode current I_{CCSPLL} with the following settings: <ul style="list-style-type: none"> • $f_{CLKS1} = f_{CLKS2} = 48MHz$ • $f_{CLKP1} = f_{CLKP2} = 24MHz$ • Regulator in High Power Mode • Core voltage at 1.8V (VRCR:HPM[1:0] = 10_B) • RC oscillator and Sub oscillator stopped
Main Sleep	Main Sleep mode current I_{CCSMAN} with the following settings: <ul style="list-style-type: none"> • $f_{CLKS1} = f_{CLKS2} = f_{CLKP1} = f_{CLKP2} = 4MHz$ • Regulator in High Power Mode • Core voltage at 1.8V (VRCR:HPM[1:0] = 10_B) • PLL, RC oscillator and Sub oscillator stopped
RC Sleep 2M	RC Sleep mode current I_{CCSRCH} with the following settings: <ul style="list-style-type: none"> • RC oscillator set to 2MHz (CKFCR:RCFS = 1) • $f_{CLKS1} = f_{CLKS2} = f_{CLKP1} = f_{CLKP2} = 2MHz$ • Regulator in High Power Mode • Core voltage at 1.8V (VRCR:HPM[1:0] = 10_B) • PLL, Main oscillator and Sub oscillator stopped

Mode name	Details
RC Sleep 100k	RC Sleep mode current I_{CCSRCL} with the following settings: <ul style="list-style-type: none"> RC oscillator set to 100kHz (CKFCR:RCFS = 0) $f_{CLKS1} = f_{CLKS2} = f_{CLKP1} = f_{CLKP2} = 100kHz$ Regulator in Low Power Mode A (SMCR:LPMS = 1) Core voltage at 1.8V (VR CR:LPMA[2:0] = 110_B) PLL, Main oscillator and Sub oscillator stopped
Sub Sleep	Sub Sleep mode current I_{CCSSUB} with the following settings: <ul style="list-style-type: none"> $f_{CLKS1} = f_{CLKS2} = f_{CLKP1} = f_{CLKP2} = 32kHz$ Regulator in Low Power Mode A (by hardware) Core voltage at 1.8V (VR CR:LPMA[2:0] = 110_B) PLL, RC oscillator and Main oscillator stopped
PLL Timer 48	PLL Timer mode current I_{CCTPLL} with the following settings: <ul style="list-style-type: none"> $f_{CLKS1} = f_{CLKS2} = 48MHz$ Regulator in High Power Mode Core voltage at 1.8V (VR CR:HPM[1:0] = 10_B) RC oscillator and Sub oscillator stopped
Main Timer	Main Timer mode current $I_{CCTMAIN}$ with the following settings: <ul style="list-style-type: none"> $f_{CLKS1} = f_{CLKS2} = 4MHz$ Regulator in Low Power Mode A (SMCR:LPMS = 1) Core voltage at 1.8V (VR CR:LPMA[2:0] = 110_B) PLL, RC oscillator and Sub oscillator stopped
RC Timer 2M	RC Timer mode current I_{CCTRCH} with the following settings: <ul style="list-style-type: none"> RC oscillator set to 2MHz (CKFCR:RCFS = 1) $f_{CLKS1} = f_{CLKS2} = 2MHz$ Regulator in Low Power Mode A (SMCR:LPMS = 1) Core voltage at 1.8V (VR CR:LPMA[2:0] = 110_B) PLL, Main oscillator and Sub oscillator stopped
RC Timer 100k	RC Timer mode current I_{CCTRCL} with the following settings: <ul style="list-style-type: none"> RC oscillator set to 100kHz (CKFCR:RCFS = 0) $f_{CLKS1} = f_{CLKS2} = 100kHz$ Regulator in Low Power Mode A (SMCR:LPMS = 1) Core voltage at 1.8V (VR CR:LPMA[2:0] = 110_B) PLL, Main oscillator and Sub oscillator stopped
Sub Timer	Sub Timer mode current I_{CCTSUB} with the following settings: <ul style="list-style-type: none"> $f_{CLKS1} = f_{CLKS2} = 32kHz$ Regulator in Low Power Mode A (by hardware) Core voltage at 1.8V (VR CR:LPMA[2:0] = 110_B) PLL, RC oscillator and Main oscillator stopped
Stop 1.8V	Stop mode current I_{CCH} with the following settings: <ul style="list-style-type: none"> Regulator in Low Power Mode B (by hardware) Core voltage at 1.8V (VR CR:LPMB[2:0] = 110_B)
Stop 1.2V	Stop mode current I_{CCH} with the following settings: <ul style="list-style-type: none"> Regulator in Low Power Mode B (by hardware) Core voltage at 1.2V (VR CR:LPMB[2:0] = 000_B)

CY96F313/F315 PLL Run and Sleep mode currents

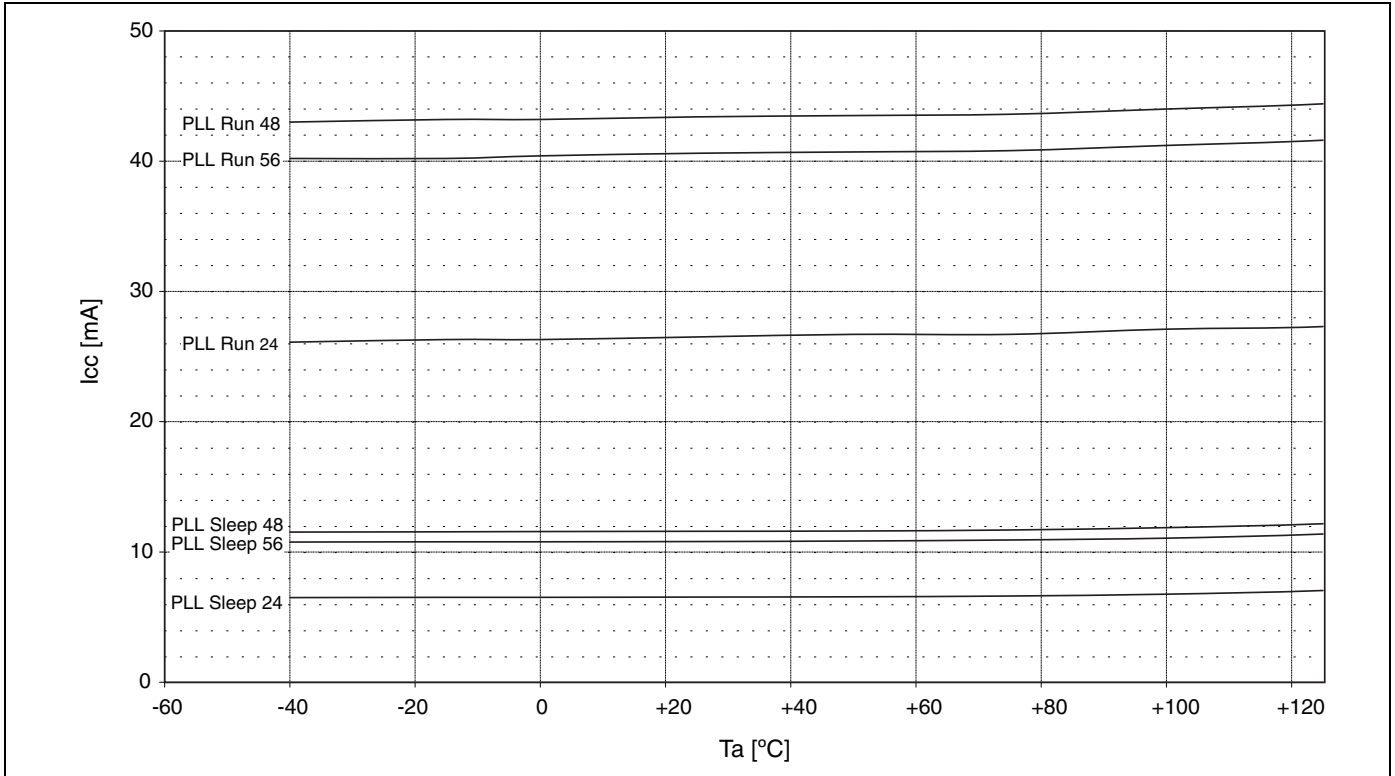

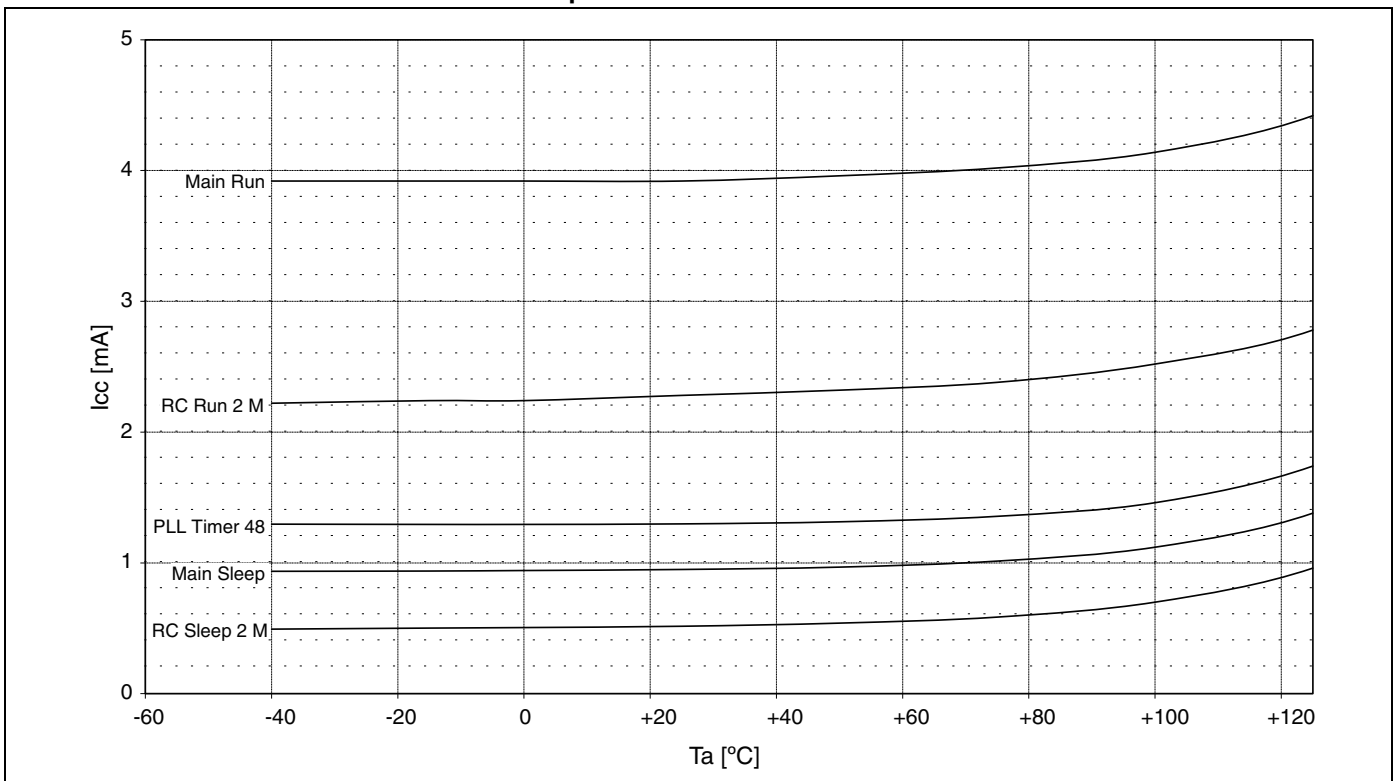
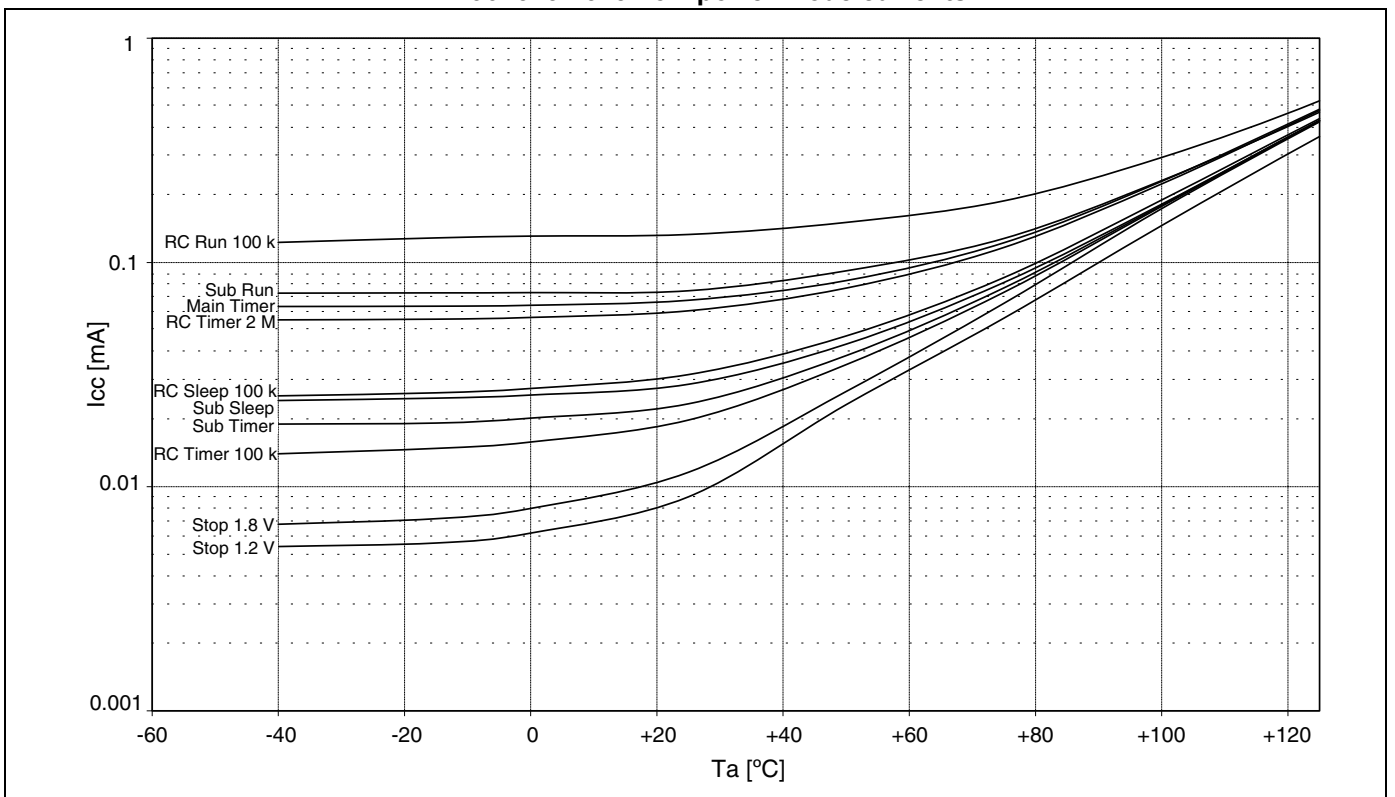
CY96F313/F315 operation modes with medium currents

CY96F313/F315 Low power mode currents

15.2 Frequency dependency of power supply currents in PLL Run mode

The following diagrams show the current consumption of samples with typical wafer process parameters in PLL Run mode at different frequencies and Flash timing settings.

Measurement conditions:

- $V_{CC} = AV_{CC} = 5.0V$
- $T_a = 25^{\circ}C$
- $f_{CLKS1} = f_{CLKB}$ or $f_{CLKS1} = 2 * f_{CLKB}$ as described in diagram
- $f_{CLKS2} = f_{CLKS1}$
- $f_{CLKP1} = f_{CLKB}$
- $f_{CLKP2} = f_{CLKB}/2$
- Core voltage at 1.8V (VRCR:HPM[1:0] = 10_B) or 1.9V (VRCR:HPM[1:0] = 11_B) as described in diagram
- Main clock = 4MHz external clock
- Flash memory timing settings:
 - MTCRA=2128_H/2208_H (0 Flash wait states, $f_{CLKS1} = 2 * f_{CLKB}$)
 - MTCRA=0239_H/2129_H (1 Flash wait state, $f_{CLKS1} = f_{CLKB}$)
 - MTCRA=4C09_H/6B09_H (1 Flash wait state, $f_{CLKS1} = 2 * f_{CLKB}$)
 - MTCRA=233A_H (2 Flash wait states, $f_{CLKS1} = f_{CLKB}$)
- Average Flash access rate (number of read accesses to the Flash per CLKB clock cycle, no buffer hit):
 - 0 Flash wait states: 0.5
 - 1 Flash wait states: 0.33
 - 2 Flash wait states: 0.25

CY96F313/F315 PLL Run mode currents

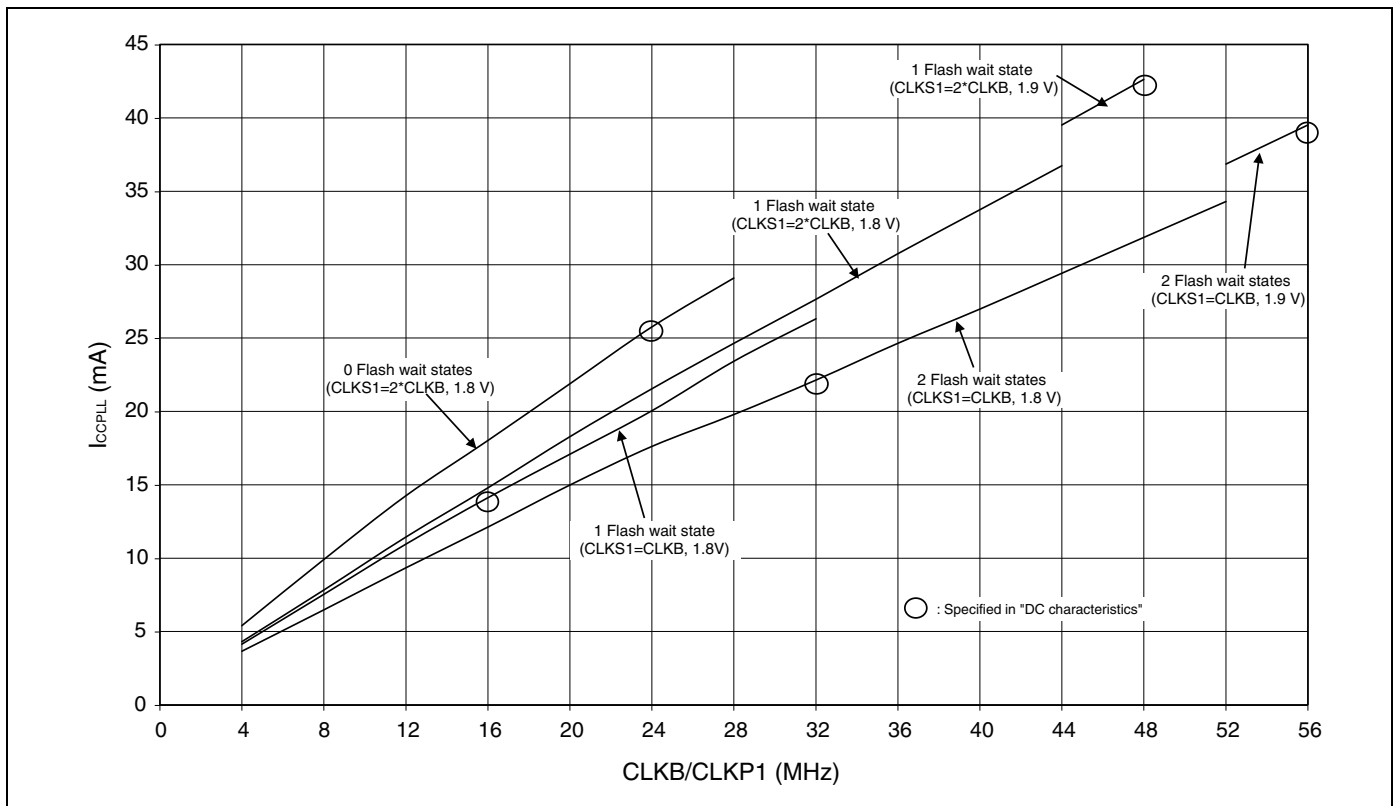

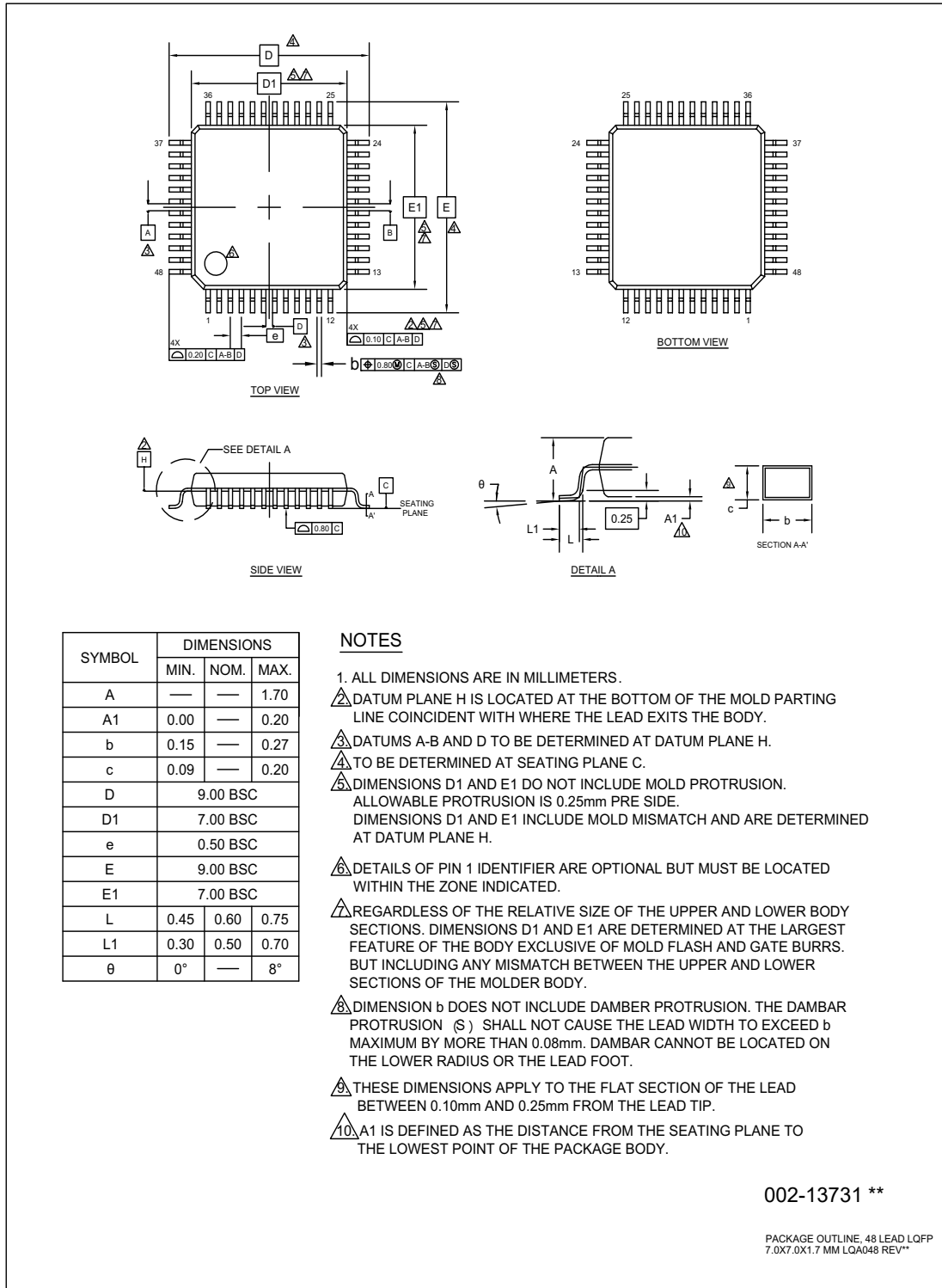
16. Package Dimension CY96(F)31x LQFP48

17. Ordering Information

MCU with CAN controller

Part number	Flash/ROM	Subclock	Persistent Low Voltage Reset	Package
CY96F313RSBPMC-GS-UJE2	Flash A (96KB)	No	No	48 pins Plastic LQFP (LQA048)
CY96F315RSBPMC-GS-UJE1	Flash A (160KB)	No	No	
CY96F315RSBPMC-GS-UJE2		No	No	

MCU without CAN controller

Part number	Flash/ROM	Subclock	Persistent Low Voltage Reset	Package
CY96F313ASBPMC-GS-UJE2	Flash A (96KB)	No	No	48 pins Plastic LQFP (LQA048)

18. Revision History

Revision	Date	Modification
Prelim 1	2008-12-09	Creation
Prelim 2	2009-01-09	<ul style="list-style-type: none">• Interrupt vector table corrected (description of CAN2 interrupt)• Low voltage detector spec updated (detection levels and stabilization time)• C-Pin cap spec updated: 4.7uF-10uF capacitor with tolerance permitted

19. Major Changes

Spancion Publication Number: DS07-13808-2E

Page	Section	Change Results
3	Features	Corrected the sentence “Reload timer overflow” to “Reload timer underflow” for Programmable Pulse Generator.
5, 6	Product Lineup	Removed footnote. Changed name of evaluation sample.
8	Pin Assignments	Corrected pin number of X0. 34 → 35
14	Memory Map	Changed name of evaluation sample.
17	Serial Programming Communication Interface	Corrected device name, package name and pin numbers.
49-50	Electrical Characteristics 3.DC Characteristics	Note added in DC characteristics how to select driving strength of ports.
51-56	Electrical Characteristics 3.DC Characteristics	Updated I _{cc} specs. Updated Power Supply current spec in Run/Sleep/Timer/Stop modes (new spec items in PLL Run/Sleep mode, small adjustment of most other values).
57	Electrical Characteristics 4.AC Characteristics	Note added that PLL phase jitter spec does not include jitter coming from Main clock. Added specification of RC clock stabilization time.
65	Electrical Characteristics 5. Analog Digital Converter	Changed the item for “Zero reading voltage” and “Full scale reading voltage”. AD converter I _{AIN} spec improved: 1uA valid up to 105deg, 1.2uA above 105deg.
68	Electrical Characteristics 5. Analog Digital Converter	“Notes on A/D Converter Section” was rewrite and renamed to “Accuracy and setting of the A/D Converter sampling time”. Impact of input pin capacitance and external capacitance added to formula for calculation of the sampling time.
69	Electrical Characteristics 6. Low Voltage Detector Characteristics	Detection levels updated.
72-77	Example Characteristics	Added.
78	Package Dimension MB96(F)31x LQFP48	Updated package figure. Added the following sentence under the figure: “Please check the latest package dimension at the following URL. http://edevice.fujitsu.com/package/en-search/ ”.
79	Ordering Information	Updated part number: MB96F313/F315**A → MB96F313/F315**B Removed footnote. Added Part Numbers “MB96F313RSB PMC-GSE1”, “MB96F315RSB PMC-GSE1”.
Rev.*B		
-	Marketing Part Numbers changed from an MB prefix to CY prefix	
5, 7, 10, 77	1. Product Lineup 3. Pin Assignment 5. Pin Circuit Type 17. Ordering Information	Package description modified to JDEC description. FPT-48P-M26 → LQA048

Page	Section	Change Results
77	17. Ordering Information	<p>MCU with CAN controller</p> <p>Deleted the following parts number:</p> <ul style="list-style-type: none"> - MB96F313YSBPMC-GSE2 - MB96F313RSBPMC-GSE1 - MB96F313YWBPMC-GSE2 - MB96F313RWBPMC-GSE2 - MB96F315YSBPMC-GSE2 - MB96F315YWBPMC-GSE2 - MB96F315RWBPMC-GSE2 - MB96V300CRB-ES <p>Changed the following parts number:</p> <ul style="list-style-type: none"> - MB96F313RSBPMC-GSE2 → CY96F313RSBPMC-GS-UJE2 - MB96F315RSBPMC-GSE1 → CY96F315RSBPMC-GS-UJE1 - MB96F315RSBPMC-GSE2 → CY96F315RSBPMC-GS-UJE2 <p>MCU without CAN controller</p> <p>Deleted the following parts number:</p> <ul style="list-style-type: none"> - MB96F313AWBPMC-GSE2 - MB96F315AWBPMC-GSE2 - MB96F315ASBPMC-GSE2 <p>Changed the following parts number:</p> <ul style="list-style-type: none"> - MB96F313ASBPMC-GSE2 → CY96F313ASBPMC-GS-UJE2

NOTE: Please see “Document History” about later revised information.

Document History

Document Title: CY96310 Series F ² MC-16FX 16-bit Proprietary Microcontroller Document Number: 002-04592				
Revision	ECN	Orig. of Change	Submission Date	Description of Change
**	–	AKIH	08/04/2010	Migrated to Cypress and assigned document number 002-04592. No change to document contents or format.
*A	5230360	AKIH	04/22/2016	Updated to Cypress template.
*B	6195944	WAFA	06/04/2018	Revised the following items: Marketing Part Numbers changed from an MB prefix to a CY prefix. 1. Product Lineup 3. Pin Assignment 5. Pin Circuit Type 17. Ordering Information For details, please see 19. Major Changes.
*C	6580079	ATSE	05/23/2019	Updated to new template. Completing Sunset Review.

Sales, Solutions, and Legal Information

Worldwide Sales and Design Support

Cypress maintains a worldwide network of offices, solution centers, manufacturer's representatives, and distributors. To find the office closest to you, visit us at [Cypress Locations](#).

Products

Arm® Cortex® Microcontrollers	cypress.com/arm
Automotive	cypress.com/automotive
Clocks & Buffers	cypress.com/clocks
Interface	cypress.com/interface
Internet of Things	cypress.com/iot
Memory	cypress.com/memory
Microcontrollers	cypress.com/mcu
PSoC	cypress.com/psoc
Power Management ICs	cypress.com/pmic
Touch Sensing	cypress.com/touch
USB Controllers	cypress.com/usb
Wireless Connectivity	cypress.com/wireless

PSoC® Solutions

[PSoC 1](#) | [PSoC 3](#) | [PSoC 4](#) | [PSoC 5LP](#) | [PSoC 6 MCU](#)

Cypress Developer Community

[Community](#) | [Projects](#) | [Video](#) | [Blogs](#) | [Training](#) | [Components](#)

Technical Support

cypress.com/support

© Cypress Semiconductor Corporation, 2010–2019. This document is the property of Cypress Semiconductor Corporation and its subsidiaries ("Cypress"). This document, including any software or firmware included or referenced in this document ("Software"), is owned by Cypress under the intellectual property laws and treaties of the United States and other countries worldwide. Cypress reserves all rights under such laws and treaties and does not, except as specifically stated in this paragraph, grant any license under its patents, copyrights, trademarks, or other intellectual property rights. If the Software is not accompanied by a license agreement and you do not otherwise have a written agreement with Cypress governing the use of the Software, then Cypress hereby grants you a personal, non-exclusive, nontransferable license (without the right to sublicense) (1) under its copyright rights in the Software (a) for Software provided in source code form, to modify and reproduce the Software solely for use with Cypress hardware products, only internally within your organization, and (b) to distribute the Software in binary code form externally to end users (either directly or indirectly through resellers and distributors), solely for use on Cypress hardware product units, and (2) under those claims of Cypress's patents that are infringed by the Software (as provided by Cypress, unmodified) to make, use, distribute, and import the Software solely for use with Cypress hardware products. Any other use, reproduction, modification, translation, or compilation of the Software is prohibited.

TO THE EXTENT PERMITTED BY APPLICABLE LAW, CYPRESS MAKES NO WARRANTY OF ANY KIND, EXPRESS OR IMPLIED, WITH REGARD TO THIS DOCUMENT OR ANY SOFTWARE OR ACCOMPANYING HARDWARE, INCLUDING, BUT NOT LIMITED TO, THE IMPLIED WARRANTIES OF MERCHANTABILITY AND FITNESS FOR A PARTICULAR PURPOSE. No computing device can be absolutely secure. Therefore, despite security measures implemented in Cypress hardware or software products, Cypress shall have no liability arising out of any security breach, such as unauthorized access to or use of a Cypress product. CYPRESS DOES NOT REPRESENT, WARRANT, OR GUARANTEE THAT CYPRESS PRODUCTS, OR SYSTEMS CREATED USING CYPRESS PRODUCTS, WILL BE FREE FROM CORRUPTION, ATTACK, VIRUSES, INTERFERENCE, HACKING, DATA LOSS OR THEFT, OR OTHER SECURITY INTRUSION (collectively, "Security Breach"). Cypress disclaims any liability relating to any Security Breach, and you shall and hereby do release Cypress from any claim, damage, or other liability arising from any Security Breach. In addition, the products described in these materials may contain design defects or errors known as errata which may cause the product to deviate from published specifications. To the extent permitted by applicable law, Cypress reserves the right to make changes to this document without further notice. Cypress does not assume any liability arising out of the application or use of any product or circuit described in this document. Any information provided in this document, including any sample design information or programming code, is provided only for reference purposes. It is the responsibility of the user of this document to properly design, program, and test the functionality and safety of any application made of this information and any resulting product. "High-Risk Device" means any device or system whose failure could cause personal injury, death, or property damage. Examples of High-Risk Devices are weapons, nuclear installations, surgical implants, and other medical devices. "Critical Component" means any component of a High-Risk Device whose failure to perform can be reasonably expected to cause, directly or indirectly, the failure of the High-Risk Device, or to affect its safety or effectiveness. Cypress is not liable, in whole or in part, and you shall and hereby do release Cypress from any claim, damage, or other liability arising from any use of a Cypress product as a Critical Component in a High-Risk Device. You shall indemnify and hold Cypress, its directors, officers, employees, agents, affiliates, distributors, and assigns harmless from and against all claims, costs, damages, and expenses, arising out of any claim, including claims for product liability, personal injury or death, or property damage arising from any use of a Cypress product as a Critical Component in a High-Risk Device. Cypress products are not intended or authorized for use as a Critical Component in any High-Risk Device except to the limited extent that (i) Cypress's published data sheet for the product explicitly states Cypress has qualified the product for use in a specific High-Risk Device, or (ii) Cypress has given you advance written authorization to use the product as a Critical Component in the specific High-Risk Device and you have signed a separate indemnification agreement.

Cypress, the Cypress logo, Spansion, the Spansion logo, and combinations thereof, WICED, PSoC, CapSense, EZ-USB, F-RAM, and Traveo are trademarks or registered trademarks of Cypress in the United States and other countries. For a more complete list of Cypress trademarks, visit cypress.com. Other names and brands may be claimed as property of their respective owners.

Looking for pricing, stock, or lifecycle information?

Click below to explore more details on WIN SOURCE:

- ⊖ [View MB96F313RSBPMC-GSE2 on WIN SOURCE](#)
- ⊖ [Cypress Semiconductor Corp Information](#)

Optimize Your Supply Chain with WIN SOURCE Solutions

- ✓ Global Sourcing Solution
- ✓ Obsolete Management
- ✓ Cost Control Management
- ✓ Shortage Management
- ✓ Alternative Solution
- ✓ Excess Inventory Management