



**THE DATASHEET OF  
MB95F434KPMC-G-SNE2**



## 8-bit Microcontrollers

CMOS

# New 8FX MB95430H Series

**MB95F432H/F433H/F434H**  
**MB95F432K/F433K/F434K**

### ■ DESCRIPTION

MB95430H is a series of general-purpose, single-chip microcontrollers. In addition to a compact instruction set, the microcontrollers of this series contain a variety of peripheral resources.

### ■ FEATURES

- F<sup>2</sup>MC-8FX CPU core

Instruction set optimized for controllers

- Multiplication and division instructions
- 16-bit arithmetic operations
- Bit test branch instructions
- Bit manipulation instructions, etc.

Note: F<sup>2</sup>MC is the abbreviation of FUJITSU Flexible Microcontroller.

- Clock

- Selectable main clock source

Main OSC clock (up to 16.25 MHz, maximum machine clock frequency: 8.125 MHz)

External clock (up to 32.5 MHz, maximum machine clock frequency: 16.25 MHz)

Main CR clock (1/8/10/12.5 MHz  $\pm$ 2%, maximum machine clock frequency: 12.5 MHz)

- Selectable subclock source

Sub-OSC clock (32.768 kHz)

External clock (32.768 kHz)

Sub-CR clock (Typ: 100 kHz, Min: 50 kHz, Max: 200 kHz)

- Timer

- 8/16-bit composite timer  $\times$  1 channel
- 16-bit PPG  $\times$  1 channel
- 16-bit free-running timer  $\times$  1 channel
- 16-bit output compare  $\times$  2 channels
- Time-base timer  $\times$  1 channel
- Watch prescaler  $\times$  1 channel

- UART/SIO  $\times$  1 channel

- Full duplex double buffer
- Capable of clock-asynchronous (UART) serial data transfer and clock-synchronous (SIO) serial data transfer

(Continued)

For the information for microcontroller supports, see the following website.

<http://edevic.fujitsu.com/micom/en-support/>

(Continued)

- I<sup>2</sup>C × 1 channel
  - Built-in wake-up function
- Voltage comparator × 4 channels
- Operational amplifier (OPAMP) × 1 channel
  - Software-select programmable gain
  - Software-select standalone option
  - Power down function included
- External interrupt × 8 channels
  - Interrupt by edge detection (rising edge, falling edge, and both edges can be selected)
  - Can be used to wake up the device from different low power consumption (standby) modes
- 8/10-bit A/D converter × 17 channels
  - 8-bit and 10-bit resolution can be chosen.
- Low power consumption (standby) modes
  - Stop mode
  - Sleep mode
  - Watch mode
  - Time-base timer mode
- I/O port
  - MB95F432H/F433H/F434H (maximum no. of I/O ports: 28)
    - General-purpose I/O ports (N-ch open drain) : 1
    - General-purpose I/O ports (CMOS I/O) : 27
  - MB95F432K/F433K/F434K (maximum no. of I/O ports: 29)
    - General-purpose I/O ports (N-ch open drain) : 2
    - General-purpose I/O ports (CMOS I/O) : 27
- On-chip debug
  - 1-wire serial control
  - Serial writing supported (asynchronous mode)
- Hardware/software watchdog timer
  - Built-in hardware watchdog timer
  - Built-in software watchdog timer
- Low-voltage detection reset circuit (available only on MB95F432K/F433K/F434K)
  - Built-in low-voltage detector
- Clock supervisor counter
  - Built-in clock supervisor counter function
- Programmable port input voltage level
  - CMOS input level / hysteresis input level
- Dual operation Flash memory
  - The program/erase operation and the read operation can be executed in different banks (upper bank/lower bank) simultaneously.
- Flash memory security function
  - Protects the content of the Flash memory

■ PRODUCT LINE-UP

Part number	MB95F432H	MB95F433H	MB95F434H	MB95F432K	MB95F433K	MB95F434K
Parameter						
Type	Flash memory product					
Clock supervisor counter	It supervises the main clock oscillation.					
Flash memory capacity	8 Kbyte	12 Kbyte	20 Kbyte	8 Kbyte	12 Kbyte	20 Kbyte
RAM capacity	240 bytes	240 bytes	496 bytes	240 bytes	240 bytes	496 bytes
Low-voltage detection reset	No			Yes		
Reset input	Dedicated			Selected by software		
CPU functions	<ul style="list-style-type: none"> <li>• Number of basic instructions : 136</li> <li>• Instruction bit length : 8 bits</li> <li>• Instruction length : 1 to 3 bytes</li> <li>• Data bit length : 1, 8 and 16 bits</li> <li>• Minimum instruction execution time : 61.5 ns (with machine clock frequency = 16.25 MHz)</li> <li>• Interrupt processing time : 0.6 μs (with machine clock frequency = 16.25 MHz)</li> </ul>					
General-purpose I/O	<ul style="list-style-type: none"> <li>• I/O ports (Max) : 28</li> <li>• CMOS I/O : 27</li> <li>• N-ch open drain: 1</li> </ul>			<ul style="list-style-type: none"> <li>• I/O ports (Max) : 29</li> <li>• CMOS I/O : 27</li> <li>• N-ch open drain: 2</li> </ul>		
Time-base timer	Interval time: 0.256 ms to 8.3 s (with external clock frequency = 4 MHz)					
Hardware/software watchdog timer	<ul style="list-style-type: none"> <li>• Reset generation cycle                             <ul style="list-style-type: none"> <li>- Main oscillation clock at 10 MHz: 105 ms (Min)</li> </ul> </li> <li>• The sub-CR clock can be used as the source clock of the hardware watchdog timer.</li> </ul>					
Wild register	It can be used to replace three bytes of data.					
8/10-bit A/D converter	17 channels (Ch. 16 is the channel for OPAMP output.) 8-bit resolution and 10-bit resolution can be chosen.					
8/16-bit composite timer	1 channel <ul style="list-style-type: none"> <li>• The timer can be configured as an "8-bit timer × 2 channels" or a "16-bit timer × 1 channel".</li> <li>• It has built-in timer function, PWC function, PWM function and input capture function.</li> <li>• Count clock: it can be selected from internal clocks (seven types) and external clocks.</li> <li>• It can output square wave.</li> </ul>					
External interrupt	8 channels <ul style="list-style-type: none"> <li>• Interrupt by edge detection (The rising edge, falling edge, or both edges can be selected.)</li> <li>• It can be used to wake up the device from different standby modes.</li> </ul>					
On-chip debug	<ul style="list-style-type: none"> <li>• 1-wire serial control</li> <li>• It supports serial writing. (asynchronous mode)</li> </ul>					
UART/SIO	1 channel <ul style="list-style-type: none"> <li>• Data transfer with UART/SIO is enabled.</li> <li>• It has a full duplex double buffer, variable data length (5/6/7/8 bits), a built-in baud rate generator and an error detection function.</li> <li>• It uses the NRZ type transfer format.</li> <li>• LSB-first data transfer and MSB-first data transfer are available to use.</li> <li>• Clock-asynchronous (UART) serial data transfer and clock-synchronous (SIO) serial data transfer is enabled.</li> </ul>					

(Continued)

(Continued)

Part number	MB95F432H	MB95F433H	MB95F434H	MB95F432K	MB95F433K	MB95F434K
<b>Parameter</b>						
I <sup>2</sup> C	1 channel <ul style="list-style-type: none"> <li>• Master/slave transmission and receiving</li> <li>• It has a bus error function, an arbitration function, a transmission direction detection function and a wake-up function.</li> <li>• It also has functions of generating and detecting repeated START conditions.</li> </ul>					
16-bit PPG	<ul style="list-style-type: none"> <li>• PWM mode and single-shot mode are available to use.</li> <li>• Ch. 0 can work with the multi-functional timer or individually.</li> </ul>					
Output compare	<ul style="list-style-type: none"> <li>• 1 channel of 16-bit free-running timer with a compare buffer</li> <li>• 2 channels of 16-bit output compare</li> </ul>					
Voltage comparator	4 channels					
OPAMP	<ul style="list-style-type: none"> <li>• This is an operational amplifier used in an induction heater. It contains 7 software (registers) select close loop gain selections for ground current sensing according to different sense resistor values. The OPAMP can also work as a standalone OPAMP.</li> <li>• It selects closed loop gain for ground current sensing according to different sense resistor values of a standalone OPAMP.</li> </ul>					
Watch prescaler	Eight different time intervals can be selected.					
Flash memory	<ul style="list-style-type: none"> <li>• It supports automatic programming, Embedded Algorithm, and write/erase/erase-suspend/erase-resume commands.</li> <li>• It has a flag indicating the completion of the operation of Embedded Algorithm.</li> <li>• Number of write/erase cycles: 100000</li> <li>• Data retention time: 20 years</li> <li>• Flash security feature for protecting the content of the Flash memory</li> </ul>					
Standby mode	Sleep mode, stop mode, watch mode, time-base timer mode					
Package	FPT-32P-M30 DIP-32P-M06					

## ■ PACKAGES AND CORRESPONDING PRODUCTS

Part number / Package	MB95F432H	MB95F433H	MB95F434H	MB95F432K	MB95F433K	MB95F434K
FPT-32P-M30	○	○	○	○	○	○
DIP-32P-M06	○	○	○	○	○	○

○: Available

**■ DIFFERENCES AMONG PRODUCTS AND NOTES ON PRODUCT SELECTION**

## • Current consumption

When using the on-chip debug function, take account of the current consumption of flash program/erase.

For details of current consumption, see “■ ELECTRICAL CHARACTERISTICS”.

## • Package

For details of information on each package, see “■ PACKAGES AND CORRESPONDING PRODUCTS” and “■ PACKAGE DIMENSION”.

## • Operating voltage

The operating voltage varies, depending on whether the on-chip debug function is used or not.

For details of the operating voltage, see “■ ELECTRICAL CHARACTERISTICS”.

## • On-chip debug function

The on-chip debug function requires that  $V_{CC}$ ,  $V_{SS}$  and one serial wire be connected to an evaluation tool. For details of the connection method, refer to “CHAPTER 29 EXAMPLE OF SERIAL PROGRAMMING CONNECTION” in the hardware manual of the MB95430H Series.

■ PIN ASSIGNMENT

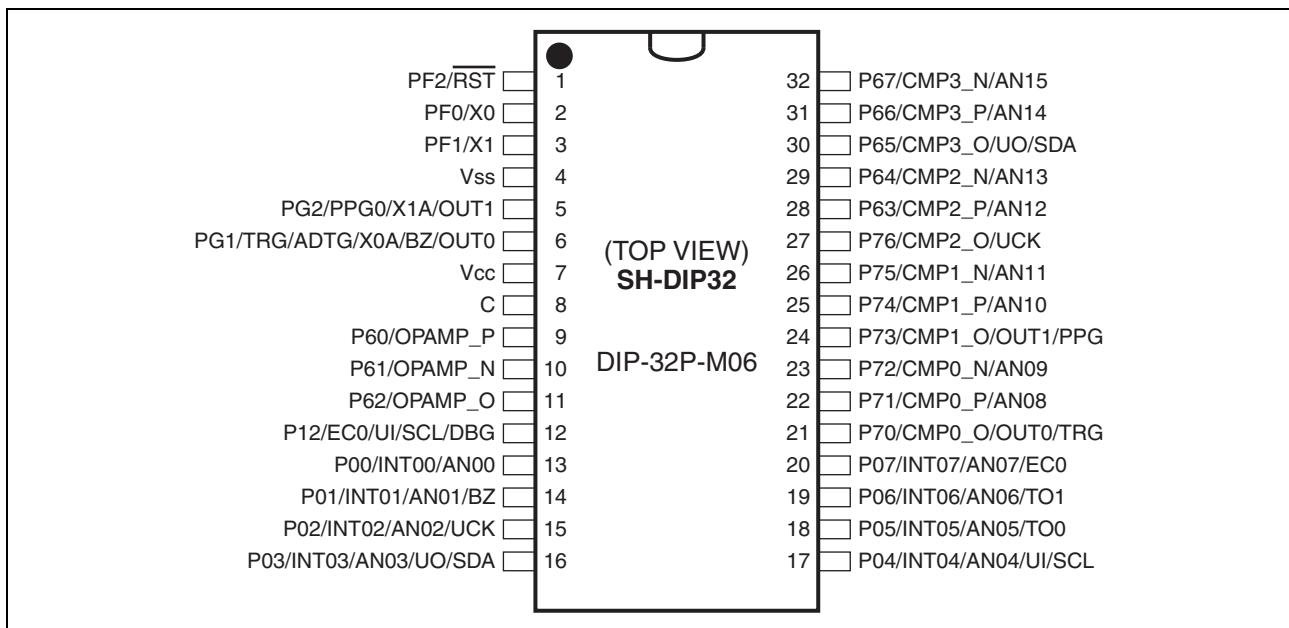
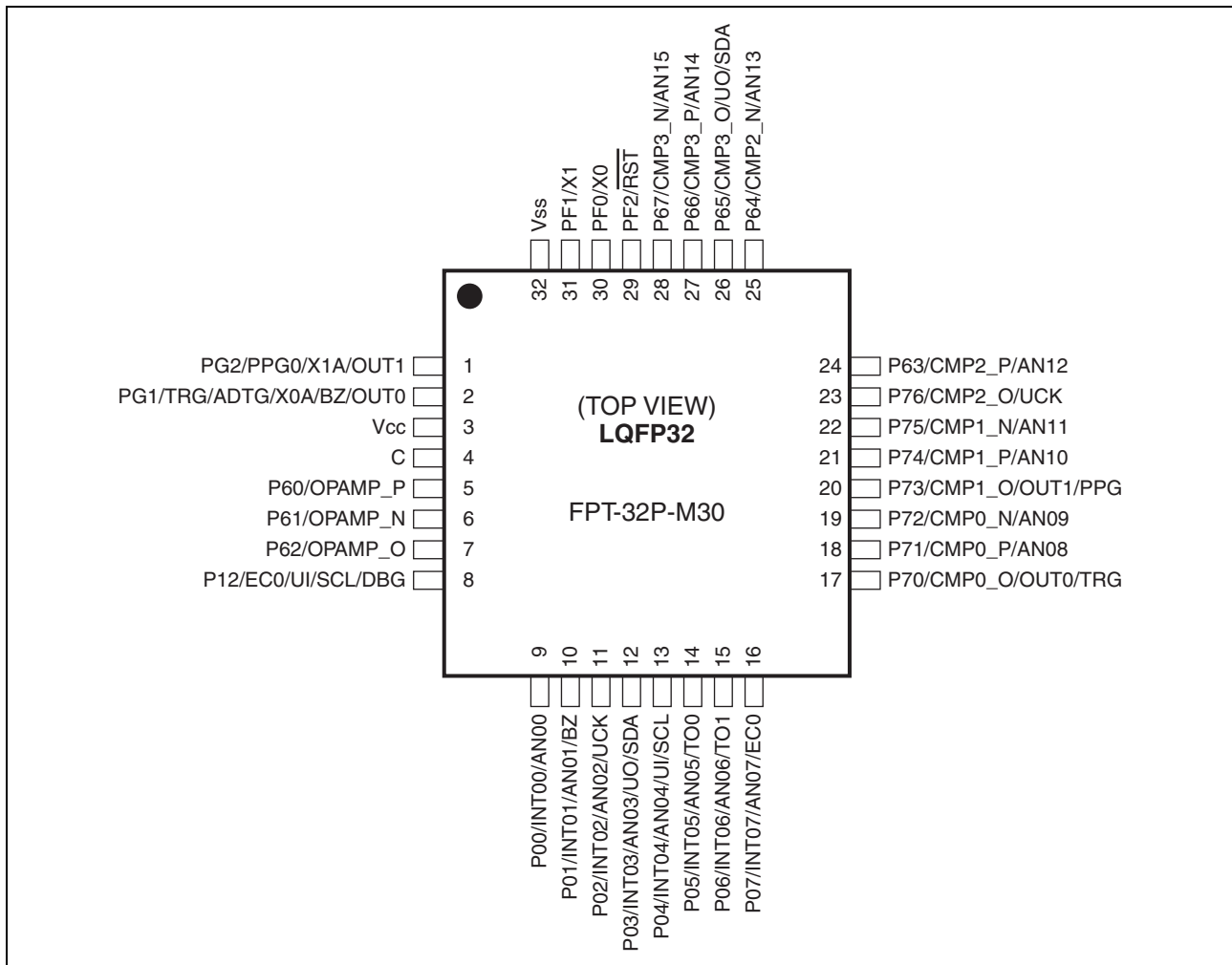

## ■ PIN DESCRIPTION

Pin no.		Pin name	I/O circuit type*3	Function
LQFP32*1	SH-DIP32*2			
1	5	PG2	C	General-purpose I/O port
		PPG		16-bit PPG output pin
		X1A		Subclock I/O oscillation pin
		OUT1		Output compare ch. 1 output pin
2	6	PG1	C	General-purpose I/O port
		TRG		16-bit PPG trigger input pin
		ADTG		A/D converter trigger input pin
		X0A		Subclock I/O oscillation pin
		BZ		Buzzer output pin
		OUT0		Output compare ch. 0 output pin
3	7	V <sub>CC</sub>	—	Power supply pin
4	8	C	—	Capacitor connection pin
5	9	P60	K	General-purpose I/O port
		OPAMP_P		Operational amplifier input pin
6	10	P61	K	General-purpose I/O port
		OPAMP_N		Operational amplifier input pin
7	11	P62	J	General-purpose I/O port
		OPAMP_O		Operational amplifier output pin
8	12	P12	H	General-purpose I/O port
		EC0		8/16-bit composite timer external clock input pin
		UI		UART/SIO data input pin
		SCL		I <sup>2</sup> C clock I/O pin
		DBG		DBG input pin
9	13	P00	E	General-purpose I/O port
		INT00		External interrupt input pin
		AN00		A/D converter analog input pin
10	14	P01	E	General-purpose I/O port
		INT01		External interrupt input pin
		AN01		A/D converter analog input pin
		BZ		Buzzer output pin
11	15	P02	E	General-purpose I/O port
		INT02		External interrupt input pin
		AN02		A/D converter analog input pin
		UCK		UART/SIO clock I/O pin

(Continued)

Pin no.		Pin name	I/O circuit type*3	Function
LQFP32*1	SH-DIP32*2			
12	16	P03	F	General-purpose I/O port
		INT03		External interrupt input pin
		AN03		A/D converter analog input pin
		UO		UART/SIO data output pin
		SDA		I <sup>2</sup> C data I/O pin
13	17	P04	F	General-purpose I/O port
		INT04		External interrupt input pin
		AN04		A/D converter analog input pin
		UI		UART/SIO data input pin
		SCL		I <sup>2</sup> C clock I/O pin
14	18	P05	E	General-purpose I/O port
		INT05		External interrupt input pin
		AN05		A/D converter analog input pin
		TO0		Timer output pin
15	19	P06	E	General-purpose I/O port
		INT06		External interrupt input pin
		AN06		A/D converter analog input pin
		TO1		Timer output pin
16	20	P07	E	General-purpose I/O port
		INT07		External interrupt input pin
		AN07		A/D converter analog input pin
		EC0		8/16-bit composite timer external clock input pin
17	21	P70	D	General-purpose I/O port
		CMP0_O		Comparator ch. 0 output pin
		OUT0		Output compare ch. 0 output pin
		TRG		16-bit PPG trigger input pin
18	22	P71	I	General-purpose I/O port
		CMP0_P		Comparator ch. 0 positive input pin
		AN08		A/D converter analog input pin
19	23	P72	I	General-purpose I/O port
		CMP0_N		Comparator ch. 0 negative input pin
		AN09		A/D converter analog input pin
20	24	P73	D	General-purpose I/O port
		CMP1_O		Comparator ch. 1 output pin
		OUT1		Output compare ch. 1 output pin
		PPG		16-bit PPG output pin

(Continued)

Created with

**nitro**<sup>PDF</sup> professional
download the free trial online at [nitropdf.com/professional](http://nitropdf.com/professional)

(Continued)

Pin no.		Pin name	I/O circuit type*3	Function
LQFP32*1	SH-DIP32*2			
21	25	P74	I	General-purpose I/O port
		CMP1_P		Comparator ch. 1 positive input pin
		AN10		A/D converter analog input pin
22	26	P75	I	General-purpose I/O port
		CMP1_N		Comparator ch. 1 negative input pin
		AN11		A/D converter analog input pin
23	27	P76	D	General-purpose I/O port
		CMP2_O		Comparator ch. 2 output pin
		UCK		UART/SIO clock I/O pin
24	28	P63	I	General-purpose I/O port
		CMP2_P		Comparator ch. 2 positive input pin
		AN12		A/D converter analog input pin
25	29	P64	I	General-purpose I/O port
		CMP2_N		Comparator ch. 2 negative input pin
		AN13		A/D converter analog input pin
26	30	P65	L	General-purpose I/O port
		CMP3_O		Comparator ch. 3 output pin
		UO		UART/SIO data output pin
		SDA		I <sup>2</sup> C data I/O pin
27	31	P66	I	General-purpose I/O port
		CMP3_P		Comparator ch. 3 positive input pin
		AN14		A/D converter analog input pin
28	32	P67	I	General-purpose I/O port
		CMP3_N		Comparator ch. 3 negative input pin
		AN15		A/D converter analog input pin
29	1	PF2	A	General-purpose I/O port
		$\overline{\text{RST}}$		Reset pin Dedicated reset pin in MB95F432H/F433H/F434H
30	2	PF0	B	General-purpose I/O port
		X0		Main clock I/O oscillation pin
31	3	PF1	B	General-purpose I/O port
		X1		Main clock I/O oscillation pin
32	4	V <sub>SS</sub>	—	Power supply pin (GND)

\*1: Package code: FPT-32P-M30

\*2: Package code: DIP-32P-M06

\*3: For the I/O circuit types, see “■ I/O CIRCUIT TYPE”.

■ I/O CIRCUIT TYPE

Type	Circuit	Remarks
A	<p>Reset input / Hysteresis input</p> <p>Reset output / Digital output</p> <p>N-ch</p>	<ul style="list-style-type: none"> <li>• N-ch open drain output</li> <li>• Hysteresis input</li> <li>• Reset output</li> </ul>
B	<p>Port select</p> <p>Digital output</p> <p>Digital output</p> <p>Standby control</p> <p>Hysteresis input</p> <p>Clock input</p> <p>X1</p> <p>X0</p> <p>Standby control / Port select</p> <p>Port select</p> <p>Digital output</p> <p>Digital output</p> <p>Standby control</p> <p>Hysteresis input</p> <p>P-ch</p> <p>N-ch</p>	<ul style="list-style-type: none"> <li>• Oscillation circuit</li> <li>• High-speed side</li> <li>Feedback resistance: approx. 1 MΩ</li> <li>• CMOS output</li> <li>• Hysteresis input</li> </ul>
C	<p>Port select</p> <p>Pull-up control</p> <p>Digital output</p> <p>Digital output</p> <p>Standby control</p> <p>Hysteresis input</p> <p>Clock input</p> <p>X1A</p> <p>X0A</p> <p>Standby control / Port select</p> <p>Port select</p> <p>Pull-up control</p> <p>Digital output</p> <p>Digital output</p> <p>Standby control</p> <p>Hysteresis input</p> <p>R</p> <p>P-ch</p> <p>N-ch</p>	<ul style="list-style-type: none"> <li>• Oscillation circuit</li> <li>• Low-speed side</li> <li>Feedback resistance: approx. 10 MΩ</li> <li>• CMOS output</li> <li>• Hysteresis input</li> <li>• Pull-up control available</li> </ul>

(Continued)

Type	Circuit	Remarks
D		<ul style="list-style-type: none"> <li>• CMOS output</li> <li>• Hysteresis input</li> </ul>
E		<ul style="list-style-type: none"> <li>• CMOS output</li> <li>• Hysteresis input</li> <li>• Pull-up control available</li> <li>• Analog input</li> </ul>
F		<ul style="list-style-type: none"> <li>• CMOS output</li> <li>• Hysteresis input</li> <li>• CMOS input</li> <li>• Pull-up control available</li> <li>• Analog input</li> <li>• N-ch open drain output (as I<sup>2</sup>C output)</li> </ul>
G		<ul style="list-style-type: none"> <li>• CMOS output</li> <li>• Hysteresis input</li> <li>• Pull-up control available</li> </ul>
H		<ul style="list-style-type: none"> <li>• N-ch open drain output</li> <li>• Hysteresis input</li> <li>• CMOS input</li> </ul>

(Continued)



## ■ NOTES ON DEVICE HANDLING

- Preventing latch-ups

When using the device, ensure that the voltage applied does not exceed the maximum voltage rating.

In a CMOS IC, if a voltage higher than  $V_{CC}$  or a voltage lower than  $V_{SS}$  is applied to an input/output pin that is neither a medium-withstand voltage pin nor a high-withstand voltage pin, or if a voltage out of the rating range of power supply voltage mentioned in "1. Absolute Maximum Ratings" of "■ ELECTRICAL CHARACTERISTICS" is applied to the  $V_{CC}$  pin or the  $V_{SS}$  pin, a latch-up may occur.

When a latch-up occurs, power supply current increases significantly, which may cause a component to be thermally destroyed.

- Stabilizing supply voltage

Supply voltage must be stabilized.

A malfunction may occur when power supply voltage fluctuates rapidly even though the fluctuation is within the guaranteed operating range of the  $V_{CC}$  power supply voltage.

As a rule of voltage stabilization, suppress voltage fluctuation so that the fluctuation in  $V_{CC}$  ripple (p-p value) at the commercial frequency (50 Hz/60 Hz) does not exceed 10% of the standard  $V_{CC}$  value, and the transient fluctuation rate does not exceed 0.1 V/ms at a momentary fluctuation such as switching the power supply.

- Notes on using the external clock

When an external clock is used, oscillation stabilization wait time is required for power-on reset, wake-up from subclock mode or stop mode.

## ■ PIN CONNECTION

- Treatment of unused pins

If an unused input pin is left unconnected, a component may be permanently damaged due to malfunctions or latch-ups. Always pull up or pull down an unused input pin through a resistor of at least 2 k $\Omega$ . Set an unused input/output pin to the output state and leave it unconnected, or set it to the input state and treat it the same as an unused input pin. If there is an unused output pin, leave it unconnected.

- Power supply pins

To reduce unnecessary electro-magnetic emission, prevent malfunctions of strobe signals due to an increase in the ground level, and conform to the total output current standard, always connect the  $V_{CC}$  pin and the  $V_{SS}$  pin to the power supply and ground outside the device. In addition, connect the current supply source to the  $V_{CC}$  pin and the  $V_{SS}$  pin with low impedance.

It is also advisable to connect a ceramic capacitor of approximately 0.1  $\mu$ F as a bypass capacitor between the  $V_{CC}$  pin and the  $V_{SS}$  pin at a location close to this device.

- DBG pin

Connect the DBG pin directly to an external pull-up resistor.

To prevent the device from unintentionally entering the debug mode due to noise, minimize the distance between the DBG pin and the  $V_{CC}$  or  $V_{SS}$  pin when designing the layout of the printed circuit board.

The DBG pin should not stay at "L" level after power-on until the reset output is released.

- $\overline{RST}$  pin

Connect the  $\overline{RST}$  pin directly to an external pull-up resistor.

To prevent the device from unintentionally entering the reset mode due to noise, minimize the distance between the  $\overline{RST}$  pin and the  $V_{CC}$  or  $V_{SS}$  pin when designing the layout of the printed circuit board.

The  $\overline{RST}/PF2$  pin functions as the reset input/output pin after power-on. In addition, the reset output of the  $\overline{RST}/PF2$  pin can be enabled by the RSTOE bit in the SYSC1 register, and the reset input function and the general purpose I/O function can be selected by the RSTEN bit in the SYSC1 register.

- C pin

Use a ceramic capacitor or a capacitor with equivalent frequency characteristics. The bypass capacitor for the  $V_{CC}$  pin must have a capacitance larger than  $C_s$ . For the connection to a smoothing capacitor  $C_s$ , see the diagram below. To prevent the device from unintentionally entering a mode to which the device is not set to transit due to noise, minimize the distance between the C pin and  $C_s$  and the distance between  $C_s$  and the  $V_{SS}$  pin when designing the layout of a printed circuit board.

- DBG/ $\overline{RST}$ /C pins connection diagram

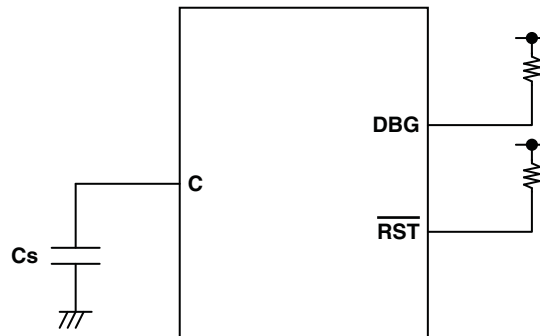

## ■ BLOCK DIAGRAM

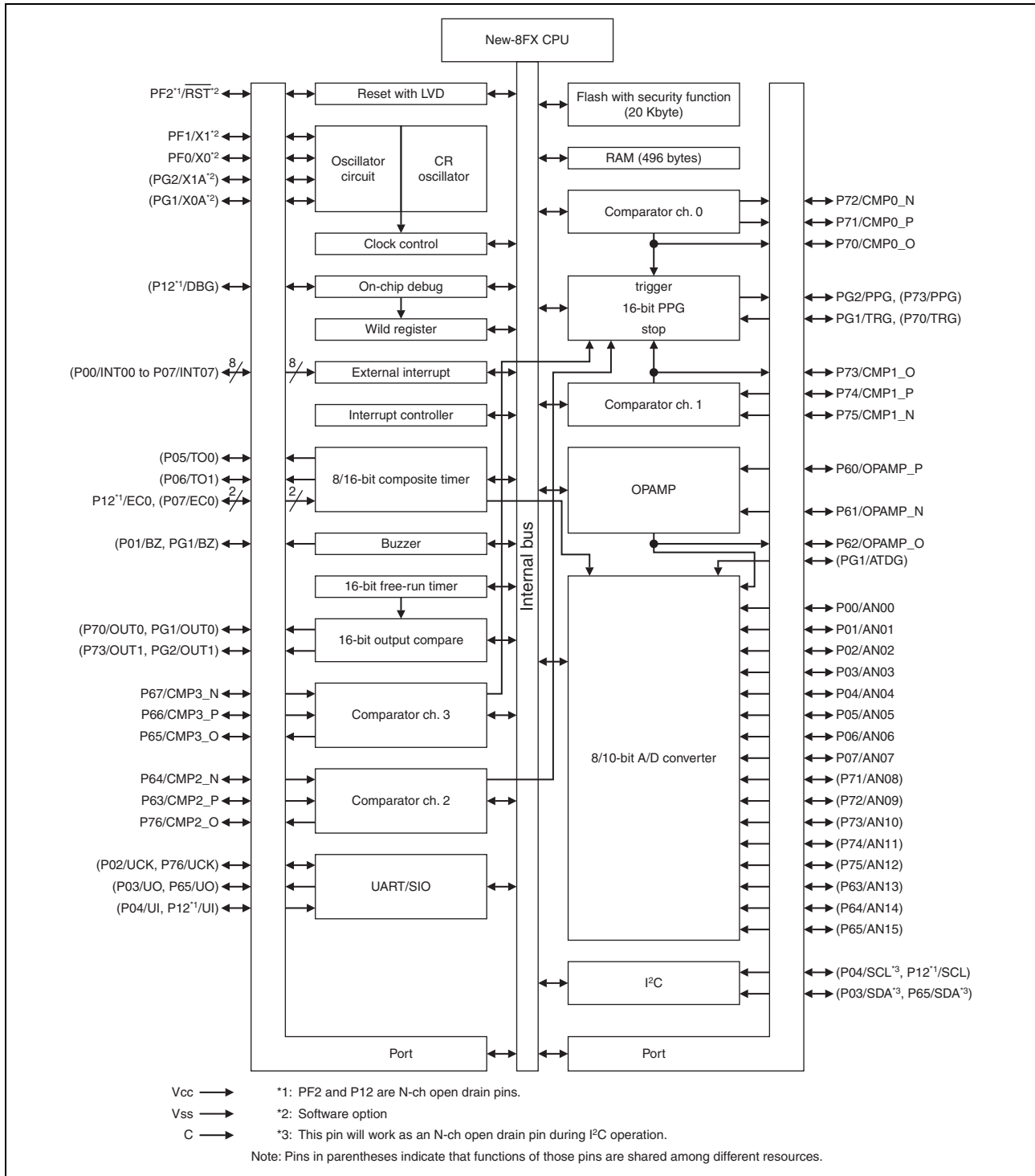

■ CPU CORE

• Memory Space

The memory space of the MB95430H Series is 64 Kbyte in size, and consists of an I/O area, a data area, and a program area. The memory space includes areas intended for specific purposes such as general-purpose registers and a vector table. The memory maps of the MB95430H Series are shown below.

• Memory Maps

MB95F432H/F432K		MB95F433H/F433K		MB95F434H/F434K	
0000 <sub>H</sub>	I/O	0000 <sub>H</sub>	I/O	0000 <sub>H</sub>	I/O
0080 <sub>H</sub>	Access prohibited	0080 <sub>H</sub>	Access prohibited	0080 <sub>H</sub>	Access prohibited
0090 <sub>H</sub>	RAM 240 bytes	0090 <sub>H</sub>	RAM 240 bytes	0090 <sub>H</sub>	RAM 496 bytes
0100 <sub>H</sub>	Register	0100 <sub>H</sub>	Register	0100 <sub>H</sub>	Register
0180 <sub>H</sub>	Access prohibited	0180 <sub>H</sub>	Access prohibited	0200 <sub>H</sub>	Access prohibited
0F80 <sub>H</sub>	Extended I/O	0F80 <sub>H</sub>	Extended I/O	0F80 <sub>H</sub>	Extended I/O
1000 <sub>H</sub>	Access prohibited	1000 <sub>H</sub>	Access prohibited	1000 <sub>H</sub>	Access prohibited
B000 <sub>H</sub>	Flash 4 Kbyte	B000 <sub>H</sub>	Flash 4 Kbyte	B000 <sub>H</sub>	Flash 20 Kbyte
C000 <sub>H</sub>	Access prohibited	C000 <sub>H</sub>	Access prohibited	E000 <sub>H</sub>	
F000 <sub>H</sub>	Flash 4 Kbyte	E000 <sub>H</sub>	Flash 8 Kbyte	FFFF <sub>H</sub>	
FFFF <sub>H</sub>		FFFF <sub>H</sub>		FFFF <sub>H</sub>	

## ■ I/O MAP

Address	Register abbreviation	Register name	R/W	Initial value
0000 <sub>H</sub>	PDR0	Port 0 data register	R/W	00000000 <sub>B</sub>
0001 <sub>H</sub>	DDR0	Port 0 direction register	R/W	00000000 <sub>B</sub>
0002 <sub>H</sub>	PDR1	Port 1 data register	R/W	00000000 <sub>B</sub>
0003 <sub>H</sub>	DDR1	Port 1 direction register	R/W	00000000 <sub>B</sub>
0004 <sub>H</sub>	—	(Disabled)	—	—
0005 <sub>H</sub>	WATR	Oscillation stabilization wait time setting register	R/W	11111111 <sub>B</sub>
0006 <sub>H</sub>	—	(Disabled)	—	—
0007 <sub>H</sub>	SYCC	System clock control register	R/W	0000X011 <sub>B</sub>
0008 <sub>H</sub>	STBC	Standby control register	R/W	00000XXX <sub>B</sub>
0009 <sub>H</sub>	RSRR	Reset source register	R/W	000XXXXX <sub>B</sub>
000A <sub>H</sub>	TBTC	Time-base timer control register	R/W	00000000 <sub>B</sub>
000B <sub>H</sub>	WPCR	Watch prescaler control register	R/W	00000000 <sub>B</sub>
000C <sub>H</sub>	WDTC	Watchdog timer control register	R/W	00XX0000 <sub>B</sub>
000D <sub>H</sub>	SYCC2	System clock control register 2	R/W	XX100011 <sub>B</sub>
000E <sub>H</sub> to 0015 <sub>H</sub>	—	(Disabled)	—	—
0016 <sub>H</sub>	PDR6	Port 6 data register	R/W	00000000 <sub>B</sub>
0017 <sub>H</sub>	DDR6	Port 6 direction register	R/W	00000000 <sub>B</sub>
0018 <sub>H</sub>	PDR7	Port 7 data register	R/W	00000000 <sub>B</sub>
0019 <sub>H</sub>	DDR7	Port 7 direction register	R/W	00000000 <sub>B</sub>
0020 <sub>H</sub> to 0027 <sub>H</sub>	—	(Disabled)	—	—
0028 <sub>H</sub>	PDRF	Port F data register	R/W	00000000 <sub>B</sub>
0029 <sub>H</sub>	DDRF	Port F direction register	R/W	00000000 <sub>B</sub>
002A <sub>H</sub>	PDRG	Port G data register	R/W	00000000 <sub>B</sub>
002B <sub>H</sub>	DDRG	Port G direction register	R/W	00000000 <sub>B</sub>
002C <sub>H</sub>	PUL0	Port 0 pull-up register	R/W	00000000 <sub>B</sub>
002D <sub>H</sub> to 0034 <sub>H</sub>	—	(Disabled)	—	—
0035 <sub>H</sub>	PULG	Port G pull-up register	R/W	00000000 <sub>B</sub>
0036 <sub>H</sub>	T01CR1	8/16-bit composite timer 01 status control register 1 ch. 0	R/W	00000000 <sub>B</sub>
0037 <sub>H</sub>	T00CR1	8/16-bit composite timer 00 status control register 1 ch. 0	R/W	00000000 <sub>B</sub>
0038 <sub>H</sub>	BUZZ	Buzzer control register	R/W	00000000 <sub>B</sub>
0039 <sub>H</sub>	—	(Disabled)	—	—

(Continued)

Address	Register abbreviation	Register name	R/W	Initial value
003A <sub>H</sub>	CMR0	Voltage comparator control register ch. 0	R/W	000X0001 <sub>B</sub>
003B <sub>H</sub>	CMR1	Voltage comparator control register ch. 1	R/W	000X0001 <sub>B</sub>
003C <sub>H</sub>	CMR2	Voltage comparator control register ch. 2	R/W	000X0001 <sub>B</sub>
003D <sub>H</sub>	CMR3	Voltage comparator control register ch. 3	R/W	000X0001 <sub>B</sub>
003E <sub>H</sub>	OPCR	OPAMP control register	R/W	00000011 <sub>B</sub>
003F <sub>H</sub> to 0041 <sub>H</sub>	—	(Disabled)	—	—
0042 <sub>H</sub>	PCNTH0	16-bit PPG status control register upper ch. 0	R/W	00000000 <sub>B</sub>
0043 <sub>H</sub>	PCNTL0	16-bit PPG status control register lower ch. 0	R/W	00000000 <sub>B</sub>
0044 <sub>H</sub>	PTGS0	16-bit PPG trigger source control register ch. 0	R/W	00000000 <sub>B</sub>
0045 <sub>H</sub>	—	(Disabled)	—	—
0046 <sub>H</sub>	OCUOC	16-bit output compare stop trigger control register	R/W	00000000 <sub>B</sub>
0047 <sub>H</sub>	—	(Disabled)	—	—
0048 <sub>H</sub>	EIC00	External interrupt circuit control register ch. 0/ch. 1	R/W	00000000 <sub>B</sub>
0049 <sub>H</sub>	EIC10	External interrupt circuit control register ch. 2/ch. 3	R/W	00000000 <sub>B</sub>
004A <sub>H</sub>	EIC20	External interrupt circuit control register ch. 4/ch. 5	R/W	00000000 <sub>B</sub>
004B <sub>H</sub>	EIC30	External interrupt circuit control register ch. 6/ch. 7	R/W	00000000 <sub>B</sub>
004C <sub>H</sub> , 004D <sub>H</sub>	—	(Disabled)	—	—
004E <sub>H</sub>	SYSC2	System control register 2	R/W	00000000 <sub>B</sub>
004F <sub>H</sub>	—	(Disabled)	—	—
0050 <sub>H</sub>	IBCR00	I <sup>2</sup> C bus control register 0	R/W	00000000 <sub>B</sub>
0051 <sub>H</sub>	IBCR10	I <sup>2</sup> C bus control register 1	R/W	00000000 <sub>B</sub>
0052 <sub>H</sub>	IBSR0	I <sup>2</sup> C bus status register	R/W	00000000 <sub>B</sub>
0053 <sub>H</sub>	IDDR0	I <sup>2</sup> C data register	R/W	00000000 <sub>B</sub>
0054 <sub>H</sub>	IAAR0	I <sup>2</sup> C address register	R/W	00000000 <sub>B</sub>
0055 <sub>H</sub>	ICCR0	I <sup>2</sup> C clock control register	R/W	00000000 <sub>B</sub>
0056 <sub>H</sub>	SMC10	UART/SIO serial mode control register 1 ch. 0	R/W	00000000 <sub>B</sub>
0057 <sub>H</sub>	SMC20	UART/SIO serial mode control register 2 ch. 0	R/W	00100000 <sub>B</sub>
0058 <sub>H</sub>	SSR0	UART/SIO serial status and data register ch. 0	R/W	00000001 <sub>B</sub>
0059 <sub>H</sub>	TDR0	UART/SIO serial output data register ch. 0	R/W	00000000 <sub>B</sub>
005A <sub>H</sub>	RDR0	UART/SIO serial input data register ch. 0	R	00000000 <sub>B</sub>
005B <sub>H</sub>	—	(Disabled)	—	—
005C <sub>H</sub>	TCDTH	16-bit free-running timer data register (upper)	R/W	00000000 <sub>B</sub>
005D <sub>H</sub>	TCDTL	16-bit free-running timer data register (lower)	R/W	00000000 <sub>B</sub>
005E <sub>H</sub>	CPCLR <sub>H</sub>	16-bit free-running timer compare clear register (upper)	R	11111111 <sub>B</sub>
005F <sub>H</sub>	CPCLR <sub>L</sub>	16-bit free-running timer compare clear register (lower)	R	11111111 <sub>B</sub>

(Continued)

Created with

Address	Register abbreviation	Register name	R/W	Initial value
0060 <sub>H</sub>	TCCSH	16-bit free-running timer control status register (upper)	R/W	01000000 <sub>B</sub>
0061 <sub>H</sub>	TCCSL	16-bit free-running timer control status register (lower)	R/W	00000000 <sub>B</sub>
0062 <sub>H</sub>	ETCCSH	16-bit free-running timer extended control status register (upper)	R/W	00000000 <sub>B</sub>
0063 <sub>H</sub>	ETCCSL	16-bit free-running timer extended control status register (lower)	R/W	00000000 <sub>B</sub>
0064 <sub>H</sub>	OCCP0H	16-bit output compare channel 0 register (upper)	R	00000000 <sub>B</sub>
0065 <sub>H</sub>	OCCP0L	16-bit output compare channel 0 register (lower)	R	00000000 <sub>B</sub>
0066 <sub>H</sub>	OCCP1H	16-bit output compare channel 1 register (upper)	R	00000000 <sub>B</sub>
0067 <sub>H</sub>	OCCP1L	16-bit output compare channel 1 register (lower)	R	00000000 <sub>B</sub>
0068 <sub>H</sub>	OCSH	16-bit output compare control status register (upper)	R/W	00000000 <sub>B</sub>
0069 <sub>H</sub>	OCSL	16-bit output compare control status register (lower)	R/W	00000000 <sub>B</sub>
006A <sub>H</sub>	OCMCR	16-bit output compare mode control register	R/W	00000000 <sub>B</sub>
006B <sub>H</sub>	EOCS	16-bit output compare extended control status register	R/W	00000000 <sub>B</sub>
006C <sub>H</sub>	ADC1	8/10-bit A/D converter control register 1	R/W	00000000 <sub>B</sub>
006D <sub>H</sub>	ADC2	8/10-bit A/D converter control register 2	R/W	00000000 <sub>B</sub>
006E <sub>H</sub>	ADDH	8/10-bit A/D converter data register (upper)	R/W	00000000 <sub>B</sub>
006F <sub>H</sub>	ADDL	8/10-bit A/D converter data register (lower)	R/W	00000000 <sub>B</sub>
0070 <sub>H</sub>	—	(Disabled)	—	—
0071 <sub>H</sub>	FSR2	Flash memory status register 2	R/W	00000000 <sub>B</sub>
0072 <sub>H</sub>	FSR	Flash memory status register	R/W	000X0000 <sub>B</sub>
0073 <sub>H</sub>	SWRE0	Flash memory sector write control register 0	R/W	00000000 <sub>B</sub>
0074 <sub>H</sub>	FSR3	Flash memory status register 3	R	0000XXXX <sub>B</sub>
0075 <sub>H</sub>	—	(Disabled)	—	—
0076 <sub>H</sub>	WREN	Wild register address compare enable register	R/W	00000000 <sub>B</sub>
0077 <sub>H</sub>	WROR	Wild register data test setting register	R/W	00000000 <sub>B</sub>
0078 <sub>H</sub>	—	(Disabled)	—	—
0079 <sub>H</sub>	ILR0	Interrupt level setting register 0	R/W	11111111 <sub>B</sub>
007A <sub>H</sub>	ILR1	Interrupt level setting register 1	R/W	11111111 <sub>B</sub>
007B <sub>H</sub>	ILR2	Interrupt level setting register 2	R/W	11111111 <sub>B</sub>
007C <sub>H</sub>	ILR3	Interrupt level setting register 3	R/W	11111111 <sub>B</sub>
007D <sub>H</sub>	ILR4	Interrupt level setting register 4	R/W	11111111 <sub>B</sub>
007E <sub>H</sub>	ILR5	Interrupt level setting register 5	R/W	11111111 <sub>B</sub>
007F <sub>H</sub> to 0F7F <sub>H</sub>	—	(Disabled)	—	—

(Continued)

Address	Register abbreviation	Register name	R/W	Initial value
0F80 <sub>H</sub>	WRARH0	Wild register address setting register (upper) ch. 0	R/W	00000000 <sub>B</sub>
0F81 <sub>H</sub>	WRARL0	Wild register address setting register (lower) ch. 0	R/W	00000000 <sub>B</sub>
0F82 <sub>H</sub>	WRDR0	Wild register data setting register ch. 0	R/W	00000000 <sub>B</sub>
0F83 <sub>H</sub>	WRARH1	Wild register address setting register (upper) ch. 1	R/W	00000000 <sub>B</sub>
0F84 <sub>H</sub>	WRARL1	Wild register address setting register (lower) ch. 1	R/W	00000000 <sub>B</sub>
0F85 <sub>H</sub>	WRDR1	Wild register data setting register ch. 1	R/W	00000000 <sub>B</sub>
0F86 <sub>H</sub>	WRARH2	Wild register address setting register (upper) ch. 2	R/W	00000000 <sub>B</sub>
0F87 <sub>H</sub>	WRARL2	Wild register address setting register (lower) ch. 2	R/W	00000000 <sub>B</sub>
0F88 <sub>H</sub>	WRDR2	Wild register data setting register ch. 2	R/W	00000000 <sub>B</sub>
0F89 <sub>H</sub>	WRARH3	Wild register address setting register (upper) ch. 3	R/W	00000000 <sub>B</sub>
0F8A <sub>H</sub>	WRARL3	Wild register address setting register (lower) ch. 3	R/W	00000000 <sub>B</sub>
0F8B <sub>H</sub>	WRDR3	Wild register data setting register ch. 3	R/W	00000000 <sub>B</sub>
0F8C <sub>H</sub> to 0F91 <sub>H</sub>	—	(Disabled)	—	—
0F92 <sub>H</sub>	T01CR0	8/16-bit composite timer 01 status control register 0 ch. 0	R/W	00000000 <sub>B</sub>
0F93 <sub>H</sub>	T00CR0	8/16-bit composite timer 00 status control register 0 ch. 0	R/W	00000000 <sub>B</sub>
0F94 <sub>H</sub>	T01DR	8/16-bit composite timer 01 data register ch. 0	R/W	00000000 <sub>B</sub>
0F95 <sub>H</sub>	T00DR	8/16-bit composite timer 00 data register ch. 0	R/W	00000000 <sub>B</sub>
0F96 <sub>H</sub>	TMCR0	8/16-bit composite timer 00/01 timer mode control register ch. 0	R/W	00000000 <sub>B</sub>
0F97 <sub>H</sub> to 0FA9 <sub>H</sub>	—	(Disabled)	—	—
0FAA <sub>H</sub>	PDCRH0	16-bit PPG down counter register (upper) ch. 0	R/W	00000000 <sub>B</sub>
0FAB <sub>H</sub>	PDCRL0	16-bit PPG down counter register (lower) ch. 0	R/W	00000000 <sub>B</sub>
0FAC <sub>H</sub>	PCSRH0	16-bit PPG cycle setting buffer register (upper) ch. 0	R/W	11111111 <sub>B</sub>
0FAD <sub>H</sub>	PCSRL0	16-bit PPG cycle setting buffer register (lower) ch. 0	R/W	11111111 <sub>B</sub>
0FAE <sub>H</sub>	PDUTH0	16-bit PPG duty setting buffer register (upper) ch. 0	R/W	11111111 <sub>B</sub>
0FAF <sub>H</sub>	PDUTL0	16-bit PPG duty setting buffer register (lower) ch. 0	R/W	11111111 <sub>B</sub>
0FB0 <sub>H</sub> to 0FBD <sub>H</sub>	—	(Disabled)	—	—
0FBE <sub>H</sub>	PSSR0	UART/SIO prescaler select register ch. 0	R/W	00000000 <sub>B</sub>
0FBF <sub>H</sub>	BRSR0	UART/SIO baud rate setting register ch. 0	R/W	00000000 <sub>B</sub>
0FC0 <sub>H</sub> , 0FC1 <sub>H</sub>	—	(Disabled)	—	—
0FC2 <sub>H</sub>	AIDRH	A/D input disable register (upper)	R/W	00000000 <sub>B</sub>
0FC3 <sub>H</sub>	AIDRL	A/D input disable register (lower)	R/W	00000000 <sub>B</sub>
0FC4 <sub>H</sub> to 0FE3 <sub>H</sub>	—	(Disabled)	—	—

(Continued)

Created with

(Continued)

Address	Register abbreviation	Register name	R/W	Initial value
0FE4 <sub>H</sub>	CRT <sub>H</sub>	Main CR clock trimming register (upper)	R/W	0XXXXXXXX <sub>B</sub>
0FE5 <sub>H</sub>	CRT <sub>L</sub>	Main CR clock trimming register (lower)	R/W	00XXXXXXXX <sub>B</sub>
0FE6 <sub>H</sub> , 0FE7 <sub>H</sub>	—	(Disabled)	—	—
0FE8 <sub>H</sub>	SYSC1	System configuration register 1	R/W	11000011 <sub>B</sub>
0FE9 <sub>H</sub>	CMCR	Clock monitoring control register	R/W	00000000 <sub>B</sub>
0FEA <sub>H</sub>	CMDR	Clock monitoring data register	R	00000000 <sub>B</sub>
0FEB <sub>H</sub>	WDTH	Watchdog timer selection ID register (upper)	R	XXXXXXXX <sub>B</sub>
0FEC <sub>H</sub>	WDTL	Watchdog timer selection ID register (lower)	R	XXXXXXXX <sub>B</sub>
0FED <sub>H</sub>	—	(Disabled)	—	—
0FEE <sub>H</sub>	ILSR	Input level select register	R/W	00000000 <sub>B</sub>
0FEF <sub>H</sub>	WICR	Interrupt pin control register	R/W	01000000 <sub>B</sub>
0FF0 <sub>H</sub> to 0FFF <sub>H</sub>	—	(Disabled)	—	—

- R/W access symbols

R/W : Readable / Writable

R : Read only

W : Write only

- Initial value symbols

0 : The initial value of this bit is “0”.

1 : The initial value of this bit is “1”.

X : The initial value of this bit is indeterminate.

Note: Do not write to an address that is “(Disabled)”. If a “(Disabled)” address is read, an indeterminate value is returned.

### ■ INTERRUPT SOURCE TABLE

Interrupt source	Interrupt request number	Vector table address		Bit name of interrupt level setting register	Priority order of interrupt sources of the same level (occurring simultaneously)
		Upper	Lower		
External interrupt ch. 0	IRQ00	FFFA <sub>H</sub>	FFFB <sub>H</sub>	L00 [1:0]	High  ↓ Low
External interrupt ch. 4					
External interrupt ch. 1	IRQ01	FFF8 <sub>H</sub>	FFF9 <sub>H</sub>	L01 [1:0]	
External interrupt ch. 5					
External interrupt ch. 2	IRQ02	FFF6 <sub>H</sub>	FFF7 <sub>H</sub>	L02 [1:0]	
External interrupt ch. 6					
External interrupt ch. 3	IRQ03	FFF4 <sub>H</sub>	FFF5 <sub>H</sub>	L03 [1:0]	
External interrupt ch. 7					
UART/SIO	IRQ04	FFF2 <sub>H</sub>	FFF3 <sub>H</sub>	L04 [1:0]	
8/16-bit composite timer ch. 0 (lower)	IRQ05	FFF0 <sub>H</sub>	FFF1 <sub>H</sub>	L05 [1:0]	
8/16-bit composite timer ch. 0 (upper)	IRQ06	FFEE <sub>H</sub>	FFEF <sub>H</sub>	L06 [1:0]	
Output compare ch. 0 match	IRQ07	FFEC <sub>H</sub>	FFED <sub>H</sub>	L07 [1:0]	
Output compare ch. 1 match	IRQ08	FFEA <sub>H</sub>	FFEB <sub>H</sub>	L08 [1:0]	
—	IRQ09	FFE8 <sub>H</sub>	FFE9 <sub>H</sub>	L09 [1:0]	
Voltage comparator ch. 0	IRQ10	FFE6 <sub>H</sub>	FFE7 <sub>H</sub>	L10 [1:0]	
Voltage comparator ch. 1	IRQ11	FFE4 <sub>H</sub>	FFE5 <sub>H</sub>	L11 [1:0]	
Voltage comparator ch. 2	IRQ12	FFE2 <sub>H</sub>	FFE3 <sub>H</sub>	L12 [1:0]	
Voltage comparator ch. 3	IRQ13	FFE0 <sub>H</sub>	FFE1 <sub>H</sub>	L13 [1:0]	
16-bit free-running timer (compare match/zero-detect/overflow)	IRQ14	FFDE <sub>H</sub>	FFDF <sub>H</sub>	L14 [1:0]	
16-bit PPG	IRQ15	FFDC <sub>H</sub>	FFDD <sub>H</sub>	L15 [1:0]	
I <sup>2</sup> C	IRQ16	FFDA <sub>H</sub>	FFDB <sub>H</sub>	L16 [1:0]	
—	IRQ17	FFD8 <sub>H</sub>	FFD9 <sub>H</sub>	L17 [1:0]	
8/10-bit A/D converter	IRQ18	FFD6 <sub>H</sub>	FFD7 <sub>H</sub>	L18 [1:0]	
Time-base timer	IRQ19	FFD4 <sub>H</sub>	FFD5 <sub>H</sub>	L19 [1:0]	
Watch prescaler	IRQ20	FFD2 <sub>H</sub>	FFD3 <sub>H</sub>	L20 [1:0]	
—	IRQ21	FFD0 <sub>H</sub>	FFD1 <sub>H</sub>	L21 [1:0]	
—	IRQ22	FFCE <sub>H</sub>	FFCF <sub>H</sub>	L22 [1:0]	
Flash memory	IRQ23	FFCC <sub>H</sub>	FFCD <sub>H</sub>	L23 [1:0]	

## ■ ELECTRICAL CHARACTERISTICS

### 1. Absolute Maximum Ratings

Parameter	Symbol	Rating		Unit	Remarks
		Min	Max		
Power supply voltage*1	$V_{CC}$	$V_{SS} - 0.3$	$V_{SS} + 6$	V	
Input voltage*1	$V_i$	$V_{SS} - 0.3$	$V_{SS} + 6$	V	*2
Output voltage*1	$V_o$	$V_{SS} - 0.3$	$V_{SS} + 6$	V	*2
Maximum clamp current	$I_{CLAMP}$	-2	+2	mA	Applicable to specific pins*3
Total maximum clamp current	$\Sigma  I_{CLAMP} $	—	20	mA	Applicable to specific pins*3
“L” level maximum output current	$I_{OL1}$	—	15	mA	Other than P05 and P06
	$I_{OL2}$		15		P05 and P06
“L” level average current	$I_{OLAV1}$	—	4	mA	Other than P05 and P06 Average output current = operating current × operating ratio (1 pin)
	$I_{OLAV2}$		12		P05 and P06 Average output current = operating current × operating ratio (1 pin)
“L” level total maximum output current	$\Sigma I_{OL}$	—	100	mA	
“L” level total average output current	$\Sigma I_{OLAV}$	—	50	mA	Total average output current = operating current × operating ratio (Total number of pins)
“H” level maximum output current	$I_{OH1}$	—	-15	mA	Other than P05 and P06
	$I_{OH2}$		-15		P05 and P06
“H” level average current	$I_{OHAV1}$	—	-4	mA	Other than P05 and P06 Average output current = operating current × operating ratio (1 pin)
	$I_{OHAV2}$		-8		P05 and P06 Average output current = operating current × operating ratio (1 pin)
“H” level total maximum output current	$\Sigma I_{OH}$	—	-100	mA	
“H” level total average output current	$\Sigma I_{OHAV}$	—	-50	mA	Total average output current = operating current × operating ratio (Total number of pins)
Power consumption	$P_d$	—	320	mW	
Operating temperature	$T_A$	-40	+85	°C	
Storage temperature	$T_{stg}$	-55	+150	°C	

(Continued)

(Continued)

\*1: The parameter is based on  $V_{SS} = 0.0$  V.

\*2:  $V_I$  and  $V_O$  must not exceed  $V_{CC} + 0.3$  V.  $V_I$  must not exceed the rated voltage. However, if the maximum current to/from an input is limited by means of an external component, the  $I_{CLAMP}$  rating is used instead of the  $V_I$  rating.

\*3: Applicable to the following pins: P00 to P07, P60 to P67, P70 to P76, PF0 and PF1

- Use under recommended operating conditions.
- Use with DC voltage (current).
- The HV (High Voltage) signal is an input signal exceeding the  $V_{CC}$  voltage. Always connect a limiting resistor between the HV (High Voltage) signal and the microcontroller before applying the HV (High Voltage) signal.
- The value of the limiting resistor should be set to a value at which the current to be input to the microcontroller pin when the HV (High Voltage) signal is input is below the standard value, irrespective of whether the current is transient current or stationary current.
- When the microcontroller drive current is low, such as in low power consumption modes, the HV (High Voltage) input potential may pass through the protective diode to increase the potential of the  $V_{CC}$  pin, affecting other devices.
- If the HV (High Voltage) signal is input when the microcontroller power supply is off (not fixed at 0 V), since power is supplied from the pins, incomplete operations may be executed.
- If the HV (High Voltage) input is input after power-on, since power is supplied from the pins, the voltage of power supply may not be sufficient to enable a power-on reset.
- Do not leave the HV (High Voltage) input pin unconnected.
- Example of a recommended circuit

- Input/Output equivalent circuit

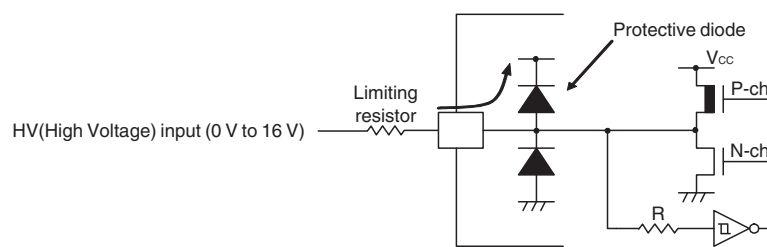

**WARNING:** Semiconductor devices can be permanently damaged by application of stress (voltage, current, temperature, etc.) in excess of absolute maximum ratings. Do not exceed these ratings.

## 2. Recommended Operating Conditions

(V<sub>SS</sub> = 0.0 V)

Parameter	Symbol	Value		Unit	Remarks	
		Min	Max			
Power supply voltage	V <sub>CC</sub>	2.4 <sup>*1*2</sup>	5.5 <sup>*1</sup>	V	In normal operation	Other than on-chip debug mode
		2.3	5.5		Hold condition in stop mode	
		2.9	5.5		In normal operation	On-chip debug mode
		2.3	5.5		Hold condition in stop mode	
Smoothing capacitor	C <sub>s</sub>	0.022	1	μF	*3	
Operating temperature	T <sub>A</sub>	-40	+85	°C	Other than on-chip debug mode	
		+5	+35		On-chip debug mode	

\*1: The value varies depending on the operating frequency, the machine clock and the analog guaranteed range.

\*2: This value becomes 2.88 V when the low-voltage detection reset is used.

\*3: Use a ceramic capacitor or a capacitor with equivalent frequency characteristics. The bypass capacitor for the V<sub>CC</sub> pin must have a capacitance larger than C<sub>s</sub>. For the connection to a smoothing capacitor C<sub>s</sub>, see the diagram below. To prevent the device from unintentionally entering an unknown mode due to noise, minimize the distance between the C pin and C<sub>s</sub> and the distance between C<sub>s</sub> and the V<sub>SS</sub> pin when designing the layout of a printed circuit board.

• DBG /  $\overline{\text{RST}}$  / C pins connection diagram

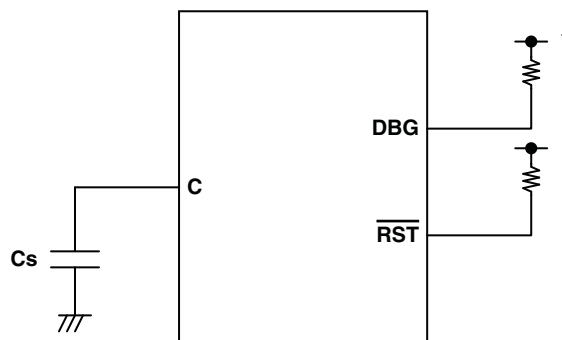

\*: Since the DBG pin becomes a communication pin in on-chip debug mode, set a pull-up resistor value suiting the input/output specifications of P12/EC0/UI/SCL/DBG.

**WARNING:** The recommended operating conditions are required in order to ensure the normal operation of the semiconductor device. All of the device's electrical characteristics are warranted when the device is operated within these ranges.

Always use semiconductor devices within their recommended operating condition ranges. Operation outside these ranges may adversely affect reliability and could result in device failure.

No warranty is made with respect to uses, operating conditions, or combinations not represented on the data sheet. Users considering application outside the listed conditions are advised to contact their representatives beforehand.

## 3. DC Characteristics

(V<sub>CC</sub> = 5.0 V ± 10%, V<sub>SS</sub> = 0.0 V, T<sub>A</sub> = -40°C to +85°C)

Parameter	Symbol	Pin name	Condition	Value			Unit	Remarks
				Min	Typ <sup>3</sup>	Max		
"H" level input voltage	V <sub>IHI</sub>	P03, P04, P12, P65	*1	0.7 V <sub>CC</sub>	—	V <sub>CC</sub> + 0.3	V	When CMOS input level (hysteresis input) is selected
	V <sub>IHS</sub>	P00 to P07, P12, P60 to P67, P70 to P76, PF0, PF1, PG1, PG2	*1	0.8 V <sub>CC</sub>	—	V <sub>CC</sub> + 0.3	V	Hysteresis input
	V <sub>IHM</sub>	PF2	—	0.7 V <sub>CC</sub>	—	V <sub>CC</sub> + 0.3	V	Hysteresis input
"L" level input voltage	V <sub>IL</sub>	P03, P04, P12, P65	*1	V <sub>SS</sub> - 0.3	—	0.3 V <sub>CC</sub>	V	When CMOS input level (hysteresis input) is selected
	V <sub>ILS</sub>	P00 to P07, P12, P60 to P67, P70 to P76, PF0, PF1, PG1, PG2	*1	V <sub>SS</sub> - 0.3	—	0.2 V <sub>CC</sub>	V	Hysteresis input
	V <sub>ILM</sub>	PF2	—	V <sub>SS</sub> - 0.3	—	0.3 V <sub>CC</sub>	V	Hysteresis input
Open-drain output application voltage	V <sub>D</sub>	P03, P04, P12, P65, PF2	—	V <sub>SS</sub> - 0.3	—	V <sub>SS</sub> + 5.5	V	P03, P04 and P65 are open-drain output pins when assigned as the SDA/SCL pin of I <sup>2</sup> C.
"H" level output voltage	V <sub>OH1</sub>	Output pins other than P05, P06, P12 and PF2	I <sub>OH</sub> = -4 mA	V <sub>CC</sub> - 0.5	—	—	V	
	V <sub>OH2</sub>	P05, P06	I <sub>OH</sub> = -8 mA	V <sub>CC</sub> - 0.5	—	—	V	
"L" level output voltage	V <sub>OL1</sub>	Output pins other than P05 and P06	I <sub>OL</sub> = 4 mA	—	—	0.4	V	
	V <sub>OL2</sub>	P05, P06	I <sub>OL</sub> = 12 mA	—	—	0.4	V	
Input leak current (Hi-Z output leak current)	I <sub>LI</sub>	All input pins	0.0 V < V <sub>I</sub> < V <sub>CC</sub>	-5	—	+5	μA	When pull-up resistance is disabled
Pull-up resistance	R <sub>PULL</sub>	P00 to P07, PG1, PG2	V <sub>I</sub> = 0 V	25	50	100	kΩ	When pull-up resistance is enabled
Input capacitance	C <sub>IN</sub>	Other than V <sub>CC</sub> and V <sub>SS</sub>	f = 1 MHz	—	5	15	pF	

(Continued)

Created with

download the free trial online at [nitropdf.com/professional](http://nitropdf.com/professional)

( $V_{CC} = 5.0\text{ V} \pm 10\%$ ,  $V_{SS} = 0.0\text{ V}$ ,  $T_A = -40^\circ\text{C}$  to  $+85^\circ\text{C}$ )

Parameter	Symbol	Pin name	Condition	Value			Unit	Remarks
				Min	Typ <sup>*3</sup>	Max		
Power supply current*2	I <sub>CC</sub>	V <sub>CC</sub> (External clock operation)	V <sub>CC</sub> = 5.5 V F <sub>CH</sub> = 32 MHz F <sub>MP</sub> = 16 MHz Main clock mode (divided by 2)	—	11.9	13.7	mA	Except during Flash memory writing and erasing
				—	17.9	21.8	mA	During Flash memory writing and erasing
				—	13.6	15.9	mA	At A/D conversion
				—	12.3	14.2	mA	When the voltage comparator is operating
				—	12.3	15.3	mA	When the OPAMP is operating
	I <sub>CCS</sub>	V <sub>CC</sub> (External clock operation)	V <sub>CC</sub> = 5.5 V F <sub>CH</sub> = 32 MHz F <sub>MP</sub> = 16 MHz Main sleep mode (divided by 2)	—	5.1	6.5	mA	
	I <sub>CCCL</sub>		V <sub>CC</sub> = 5.5 V F <sub>CL</sub> = 32 kHz F <sub>MPL</sub> = 16 kHz Subclock mode (divided by 2) T <sub>A</sub> = +25°C	—	59.2	83	μA	
	I <sub>CCLS</sub>		V <sub>CC</sub> = 5.5 V F <sub>CL</sub> = 32 kHz F <sub>MPL</sub> = 16 kHz Subsleep mode (divided by 2) T <sub>A</sub> = +25°C	—	7.8	11.3	μA	
	I <sub>CCCT</sub>		V <sub>CC</sub> = 5.5 V F <sub>CL</sub> = 32 kHz Watch mode Main stop mode T <sub>A</sub> = +25°C	—	4.2	6.5	μA	
	I <sub>CCMCR</sub>		V <sub>CC</sub>	V <sub>CC</sub> = 5.5 V F <sub>CRH</sub> = 12.5 MHz F <sub>MP</sub> = 12.5 MHz Main CR clock mode	—	9.5	11.5	mA
I <sub>CCSCR</sub>	V <sub>CC</sub> = 5.5 V Sub-CR clock mode (divided by 2) T <sub>A</sub> = +25°C	—		107.4	146.3	μA		

(Continued)

(Continued)

(V<sub>CC</sub> = 5.0 V ± 10%, V<sub>SS</sub> = 0.0 V, T<sub>A</sub> = -40°C to +85°C)

Parameter	Symbol	Pin name	Condition	Value			Unit	Remarks
				Min	Typ <sup>*3</sup>	Max		
Power supply current*2	I <sub>CCTS</sub>	V <sub>CC</sub> (External clock operation)	V <sub>CC</sub> = 5.5 V F <sub>CH</sub> = 32 MHz Time-base timer mode T <sub>A</sub> = +25°C	—	0.9	1.2	mA	
	I <sub>CCCH</sub>		V <sub>CC</sub> = 5.5 V Substop mode T <sub>A</sub> = +25°C	—	3.0	4.8	μA	
	I <sub>LVD</sub>	V <sub>CC</sub>	Current consumption for low-voltage detection circuit only	—	26.8	39.7	μA	
	I <sub>CRH</sub>		Current consumption for the main CR oscillator	—	0.2	0.4	mA	
	I <sub>CRL</sub>		Current consumption for the sub-CR oscillator oscillating at 100 kHz	—	8.0	18	μA	

\*1: The input levels of P04 can be switched between “CMOS input level” and “hysteresis input level”. The input level selection register (ILSR) is used to switch between the two input levels.

\*2: • The power supply current is determined by the external clock. When the low-voltage detection option is selected, the power-supply current will be the sum of adding the current consumption of the low-voltage detection circuit (I<sub>LVD</sub>) to one of the value from I<sub>CC</sub> to I<sub>CCCH</sub>. In addition, when both the low-voltage detection option and the CR oscillator are selected, the power supply current will be the sum of adding up the current consumption of the low-voltage detection circuit, the current consumption of the CR oscillators (I<sub>CRH</sub>, I<sub>CRL</sub>) and a specified value. In on-chip debug mode, the CR oscillator (I<sub>CRH</sub>) and the low-voltage detection circuit are always enabled, and current consumption therefore increases accordingly.

- See "4. AC Characteristics: (1) Clock Timing" for F<sub>CH</sub> and F<sub>CL</sub>.
- See "4. AC Characteristics: (2) Source Clock/Machine Clock" for F<sub>MP</sub> and F<sub>MPL</sub>.

\*3: V<sub>CC</sub> = 5.0 V, T<sub>A</sub> = 25°C

## 4. AC Characteristics

### (1) Clock Timing

( $V_{CC} = 2.4\text{ V to }5.5\text{ V}$ ,  $V_{SS} = 0.0\text{ V}$ ,  $T_A = -40^\circ\text{C to }+85^\circ\text{C}$ )

Parameter	Symbol	Pin name	Condition	Value			Unit	Remarks	
				Min	Typ	Max			
Clock frequency	F <sub>CH</sub>	X0, X1	—	1	—	16.25	MHz	When the main oscillation circuit is used	
		X0	X1: open	1	—	12	MHz	When the main external clock is used	
		X0, X1	*	1	—	32.5	MHz		
	F <sub>CRH</sub>	—	—	—	12.25	12.5	12.75	MHz	Operating conditions: • The main CR clock is used. • $T_A = -10^\circ\text{C to }+85^\circ\text{C}$
					9.8	10	10.2	MHz	
					7.84	8	8.16	MHz	
					0.98	1	1.02	MHz	
					12.1875	12.5	12.8125	MHz	Operating conditions: • The main CR clock is used. • $T_A = -40^\circ\text{C to }-10^\circ\text{C}$
					9.75	10	10.25	MHz	
					7.8	8	8.2	MHz	
	F <sub>CL</sub>	X0A, X1A	—	—	—	32.768	—	kHz	When the sub-oscillation circuit is used
					—	32.768	—	kHz	When the sub-external clock is used
	F <sub>CTL</sub>	—	—	—	50	100	200	kHz	When the sub-CR clock is used
	Clock cycle time	t <sub>H CYL</sub>	X0, X1	—	61.5	—	1000	ns	When the main oscillation circuit is used
X0			X1: open	83.4	—	1000	ns	When the external clock is used	
X0, X1			*	30.8	—	1000	ns		
t <sub>L CYL</sub>		X0A, X1A	—	—	30.5	—	μs	When the subclock is used	
Input clock pulse width	t <sub>WH1</sub>	X0	X1: open	33.4	—	—	ns	When the external clock is used, the duty ratio should range between 40% and 60%.	
	t <sub>WL1</sub>	X0, X1	*	12.4	—	—	ns		
	t <sub>WH2</sub> t <sub>WL2</sub>	X0A	—	—	15.2	—	μs		
Input clock rise time and fall time	t <sub>CR</sub>	X0	X1: open	—	—	5	ns	When the external clock is used	
	t <sub>CF</sub>	X0, X1	*	—	—	5	ns		
CR oscillation start time	t <sub>CRHWK</sub>	—	—	—	—	80	μs	When the main CR clock is used	
	t <sub>CRLWK</sub>	—	—	—	—	10	μs	When the sub-CR clock is used	

\*: The external clock signal is input to X0 and the inverted external clock signal to X1.

- Input waveform generated when an external clock (main clock) is used

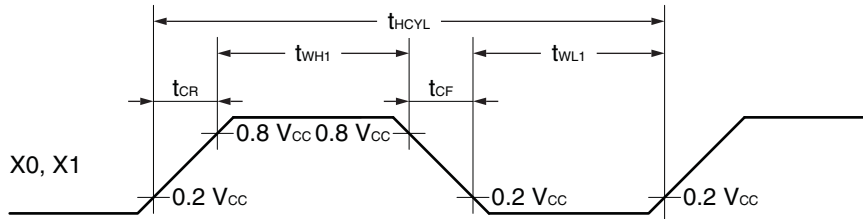

- Figure of main clock input port external connection

When a crystal oscillator or a ceramic oscillator is used

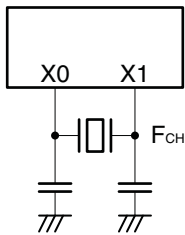

When the external clock is used (X1 is open)

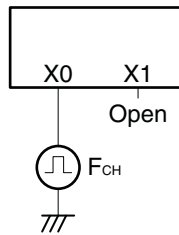

When the external clock is used

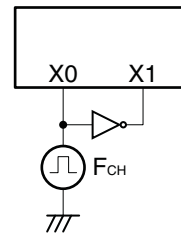

- Input waveform generated when an external clock (subclock) is used

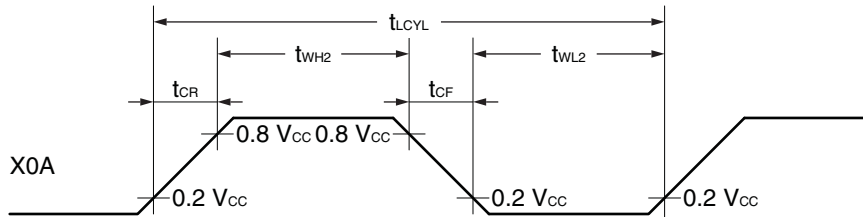

- Figure of subclock input port external connection

When a crystal oscillator or a ceramic oscillator is used

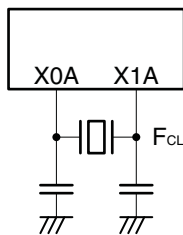

When the external clock is used

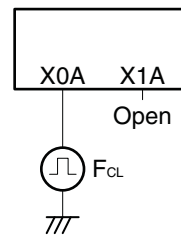

## (2) Source Clock/Machine Clock

( $V_{CC} = 5.0 V \pm 10\%$ ,  $V_{SS} = 0.0 V$ ,  $T_A = -40^\circ C$  to  $+85^\circ C$ )

Parameter	Symbol	Pin name	Value			Unit	Remarks
			Min	Typ	Max		
Source clock cycle time*1	t <sub>SCLK</sub>	—	61.5	—	2000	ns	When the main external clock is used Min: F <sub>CH</sub> = 32.5 MHz, divided by 2 Max: F <sub>CH</sub> = 1 MHz, divided by 2
			80	—	1000	ns	When the main CR clock is used Min: F <sub>CRH</sub> = 12.5 MHz Max: F <sub>CRH</sub> = 1 MHz
			—	61	—	μs	When the sub-oscillation clock is used F <sub>CL</sub> = 32.768 kHz, divided by 2
			—	20	—	μs	When the sub-CR clock is used F <sub>CRL</sub> = 100 kHz, divided by 2
Source clock frequency	F <sub>SP</sub>	—	0.5	—	16.25	MHz	When the main oscillation clock is used
			1	—	12.5	MHz	When the main CR clock is used
	—		16.384	—	kHz	When the sub-oscillation clock is used	
	—		50	—	kHz	When the sub-CR clock is used F <sub>CRL</sub> = 100 kHz, divided by 2	
Machine clock cycle time*2 (minimum instruction execution time)	t <sub>MCLK</sub>	—	61.5	—	32000	ns	When the main oscillation clock is used Min: F <sub>SP</sub> = 16.25 MHz, no division Max: F <sub>SP</sub> = 0.5 MHz, divided by 16
			80	—	16000	ns	When the main CR clock is used Min: F <sub>SP</sub> = 12.5 MHz Max: F <sub>SP</sub> = 1 MHz, divided by 16
			61	—	976.5	μs	When the sub-oscillation clock is used Min: F <sub>SPL</sub> = 16.384 kHz, no division Max: F <sub>SPL</sub> = 16.384 kHz, divided by 16
			20	—	320	μs	When the sub-CR clock is used Min: F <sub>SPL</sub> = 50 kHz, no division Max: F <sub>SPL</sub> = 50 kHz, divided by 16
Machine clock frequency	F <sub>MP</sub>	—	0.031	—	16.25	MHz	When the main oscillation clock is used
			0.0625	—	12.5	MHz	When the main CR clock is used
	1.024		—	16.384	kHz	When the sub-oscillation clock is used	
	3.125		—	50	kHz	When the sub-CR clock is used F <sub>CRL</sub> = 100 kHz	

\*1: This is the clock before it is divided according to the division ratio set by the machine clock divide ratio select bits (SYCC:DIV1, DIV0). This source clock is divided to become a machine clock according to the divide ratio set by the machine clock divide ratio select bits (SYCC:DIV1, DIV0). In addition, a source clock can be selected from the following.

- Main clock divided by 2
- Main CR clock
- Subclock divided by 2
- Sub-CR clock divided by 2

\*2: This is the operating clock of the microcontroller. A machine clock can be selected from the following.

- Source clock (no division)
- Source clock divided by 4
- Source clock divided by 8
- Source clock divided by 16

Created with

 nitroPDF<sup>®</sup> professional

download the free trial online at [nitropdf.com/professional](http://nitropdf.com/professional)

- Schematic diagram of the clock generation block

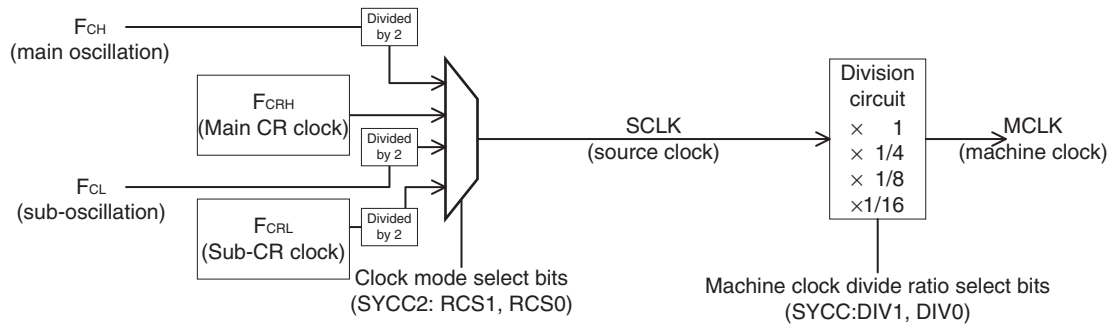

- Operating voltage - Operating frequency (When  $T_A = -40^\circ\text{C}$  to  $+85^\circ\text{C}$ )  
MB95430H (without the on-chip debug function)

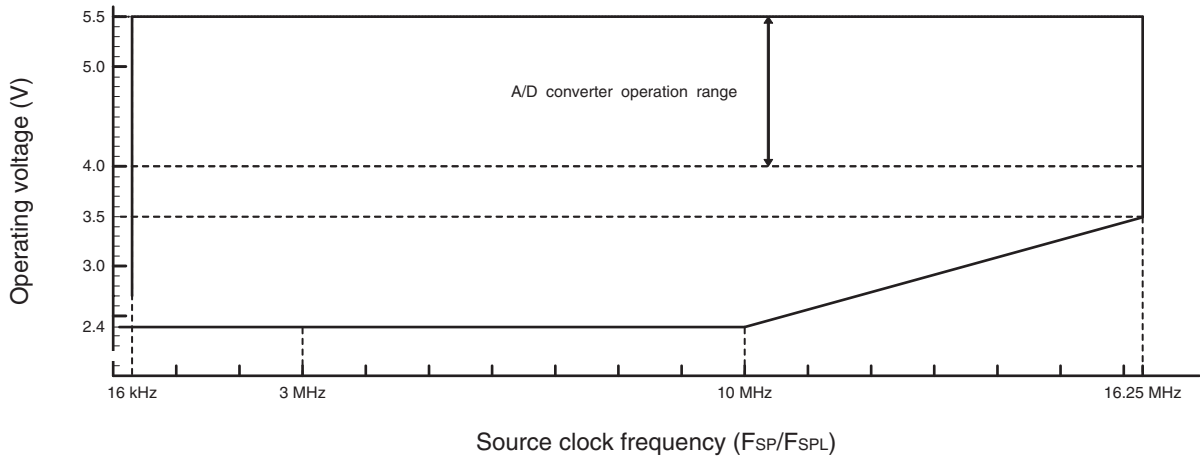

- Operating voltage - Operating frequency (When  $T_A = -40^\circ\text{C}$  to  $+85^\circ\text{C}$ )  
MB95430H (with the on-chip debug function)

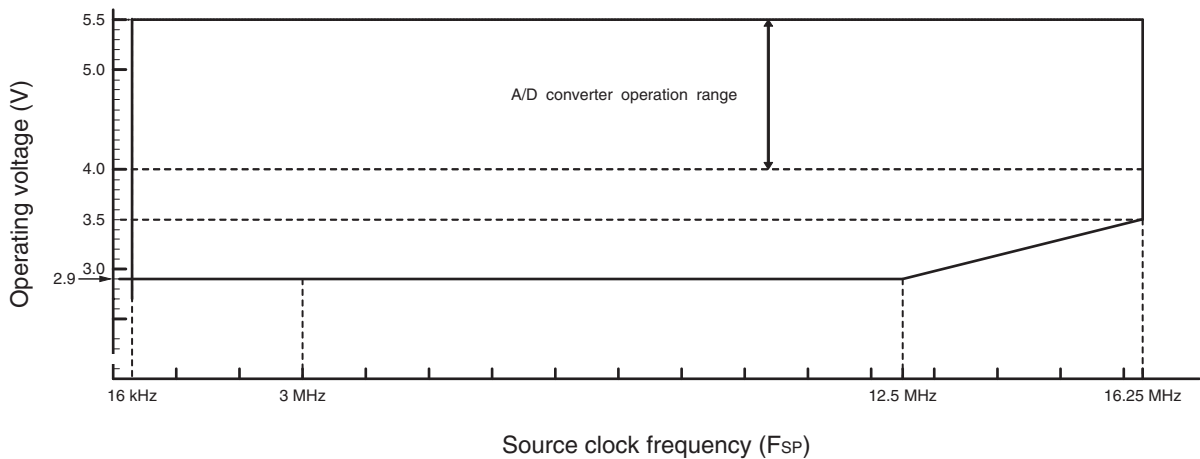

### (3) External Reset

( $V_{CC} = 5.0 V \pm 10\%$ ,  $V_{SS} = 0.0 V$ ,  $T_A = -40^\circ C$  to  $+85^\circ C$ )

Parameter	Symbol	Value		Unit	Remarks
		Min	Max		
$\overline{RST}$ "L" level pulse width	$t_{RSTL}$	$2 t_{MCLK}^{*1}$	—	ns	In normal operation
		Oscillation time of the oscillator <sup>*2</sup> + 100	—	$\mu s$	In stop mode, subclock mode, subsleep mode, watch mode, and power-on
		100	—	$\mu s$	In time-base timer mode

\*1: See "(2) Source Clock/Machine Clock" for  $t_{MCLK}$ .

\*2: The oscillation time of an oscillator is the time for it to reach 90% of its amplitude. The crystal oscillator has an oscillation time of between several ms and tens of ms. The ceramic oscillator has an oscillation time of between hundreds of  $\mu s$  and several ms. The external clock has an oscillation time of 0 ms. The CR oscillator clock has an oscillation time of between several  $\mu s$  and several ms.

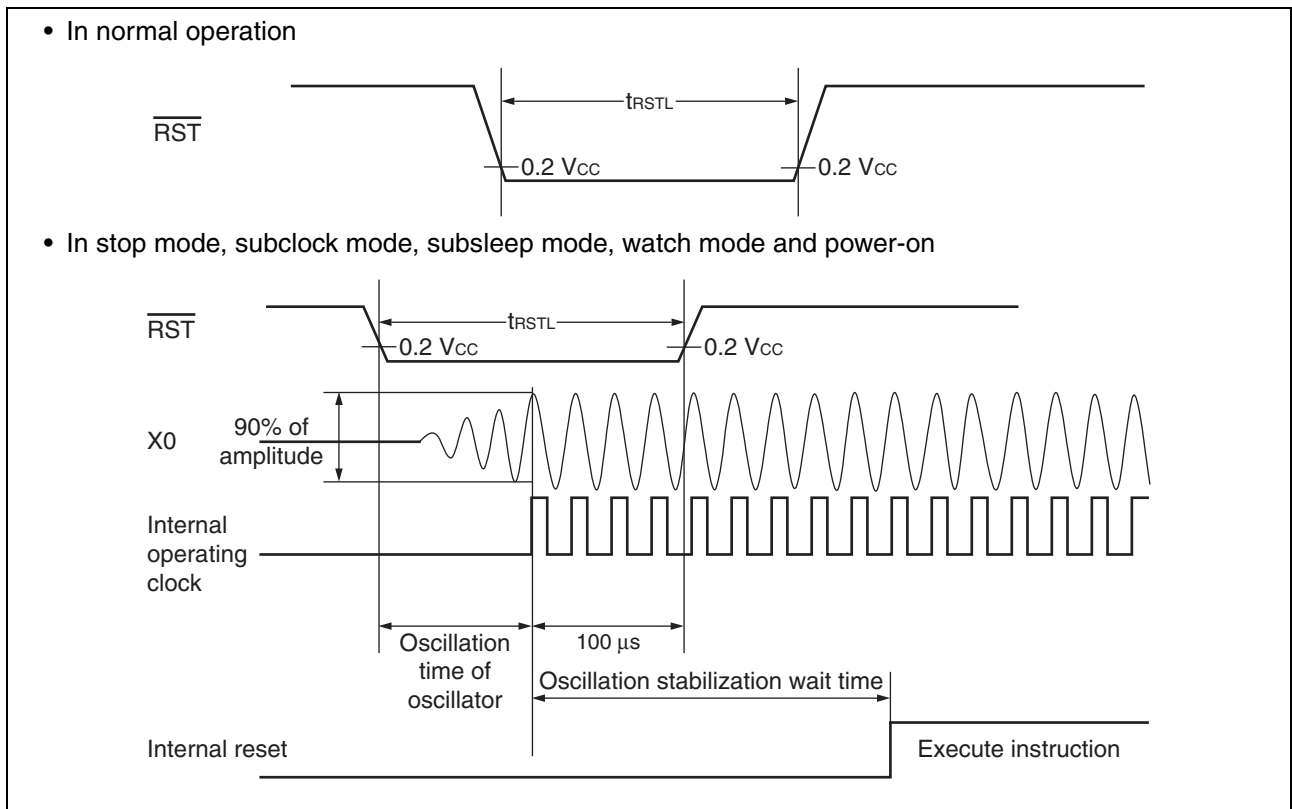

(4) Power-on Reset

( $V_{SS} = 0.0\text{ V}$ ,  $T_A = -40^\circ\text{C}$  to  $+85^\circ\text{C}$ )

Parameter	Symbol	Condition	Value		Unit	Remarks
			Min	Max		
Power supply rising time	$t_R$	—	—	50	ms	
Power supply cutoff time	$t_{OFF}$	—	1	—	ms	Wait time until power-on

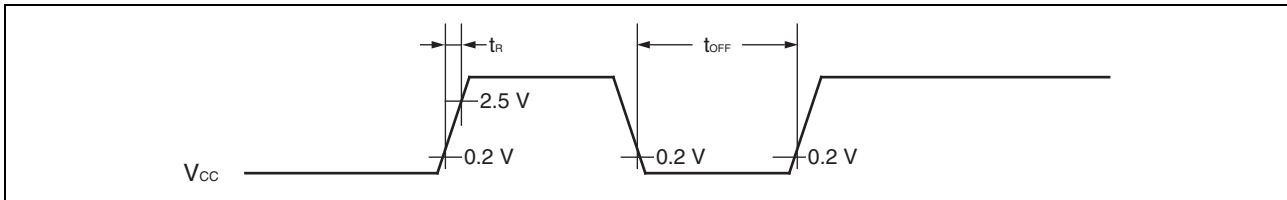

Note: A sudden change of power supply voltage may activate the power-on reset function. When changing the power supply voltage during the operation, set the slope of rising to a value below within 30 mV/ms as shown below.

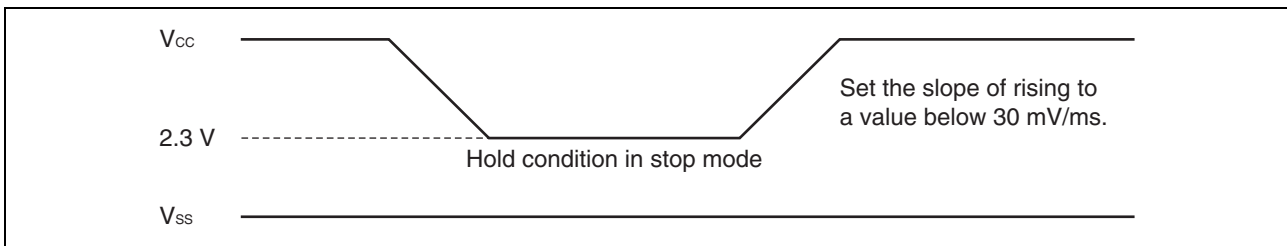

## (5) Peripheral Input Timing

( $V_{CC} = 5.0\text{ V} \pm 10\%$ ,  $V_{SS} = 0.0\text{ V}$ ,  $T_A = -40^\circ\text{C}$  to  $+85^\circ\text{C}$ )

Parameter	Symbol	Pin name	Value		Unit
			Min	Max	
Peripheral input "H" pulse width	$t_{LH}$	INT00 to INT07, EC0, ADTG,	$2 t_{MCLK}^*$	—	ns
Peripheral input "L" pulse width	$t_{HL}$	TRG	$2 t_{MCLK}^*$	—	ns

\*: See "(2) Source Clock/Machine Clock" for  $t_{MCLK}$ .

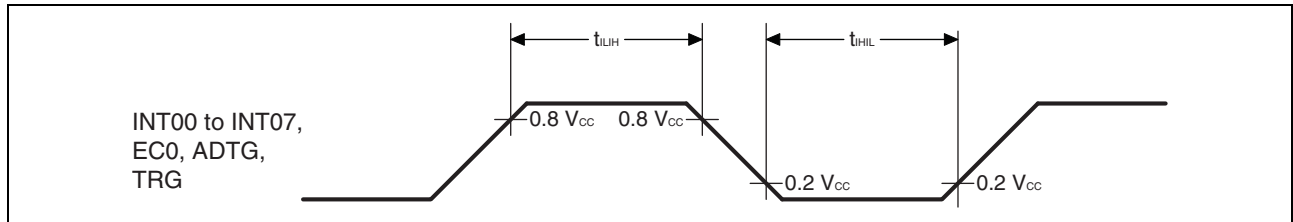

(6) UART/SIO, Serial I/O Timing

( $V_{CC} = 5.0 V \pm 10\%$ ,  $AV_{SS} = V_{SS} = 0.0 V$ ,  $T_A = -40^\circ C$  to  $+85^\circ C$ )

Parameter	Symbol	Pin name	Condition	Value		Unit
				Min	Max	
Serial clock cycle time	$t_{SCYC}$	UCK	Internal clock operation	$4 t_{MCLK}^*$	—	ns
UCK ↓ → UO time	$t_{SLOV}$	UCK, UO		-190	+190	ns
Valid UI → UCK ↑	$t_{IVSH}$	UCK, UI		$2 t_{MCLK}^*$	—	ns
UCK ↑ → valid UI hold time	$t_{SHIX}$	UCK, UI		$2 t_{MCLK}^*$	—	ns
Serial clock “H” pulse width	$t_{SHSL}$	UCK	External clock operation	$4 t_{MCLK}^*$	—	ns
Serial clock “L” pulse width	$t_{SLSH}$	UCK		$4 t_{MCLK}^*$	—	ns
UCK ↓ → UO time	$t_{SLOV}$	UCK, UO		—	190	ns
Valid UI → UCK ↑	$t_{IVSH}$	UCK, UI		$2 t_{MCLK}^*$	—	ns
UCK ↑ → valid UI hold time	$t_{SHIX}$	UCK, UI	$2 t_{MCLK}^*$	—	ns	

\*: See “(2) Source Clock/Machine Clock” for  $t_{MCLK}$ .

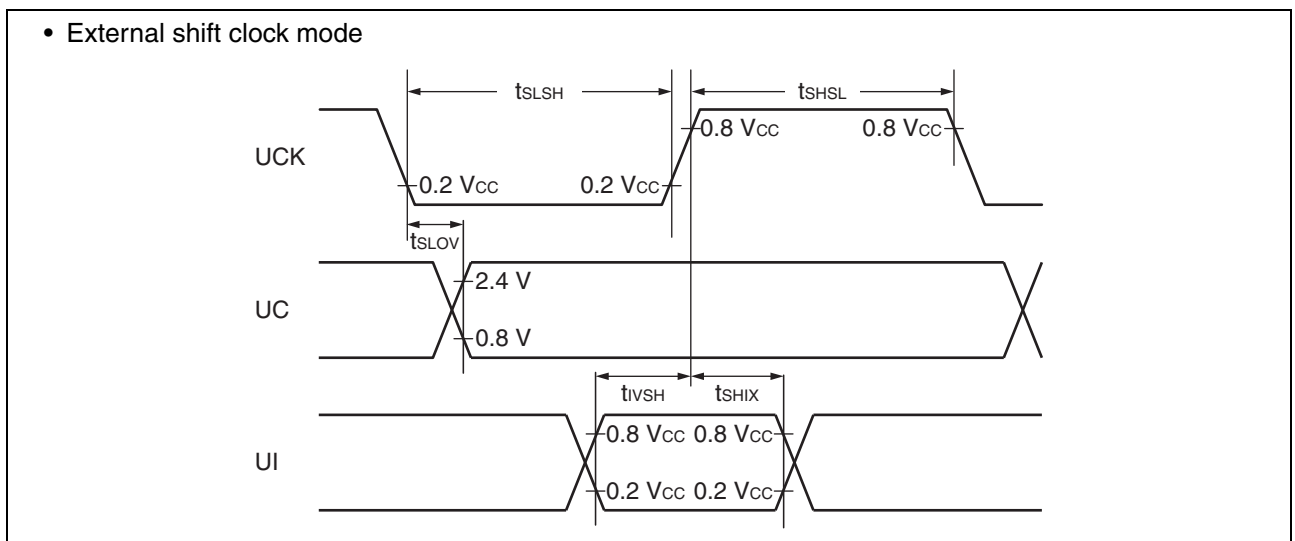
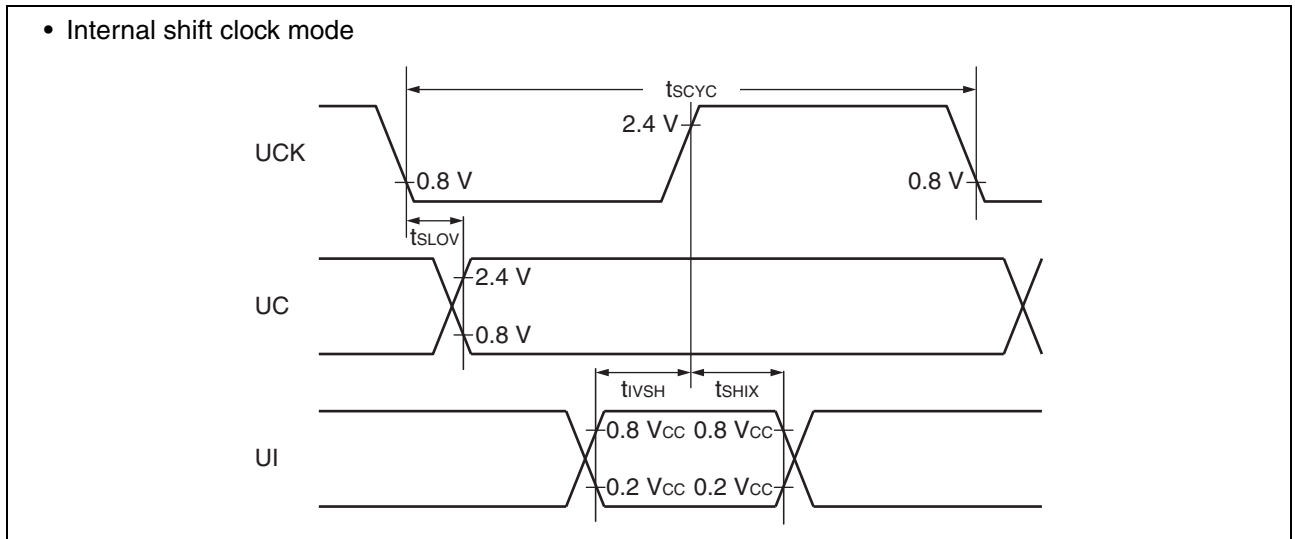

## (7) Low-voltage Detection

( $V_{SS} = 0.0\text{ V}$ ,  $T_A = -40^\circ\text{C}$  to  $+85^\circ\text{C}$ )

Parameter	Symbol	Value			Unit	Remarks
		Min	Typ	Max		
Release voltage	$V_{DL+}$	2.52	2.7	2.88	V	At power supply rise
Detection voltage	$V_{DL-}$	2.42	2.6	2.78	V	At power supply fall
Hysteresis width	$V_{HYS}$	70	100	—	mV	
Power supply start voltage	$V_{off}$	—	—	2.3	V	
Power supply end voltage	$V_{on}$	4.9	—	—	V	
Power supply voltage change time (at power supply rise)	$t_r$	3000	—	—	$\mu\text{s}$	Slope of power supply that the reset release signal generates within the rating ( $V_{DL+}$ )
Power supply voltage change time (at power supply fall)	$t_f$	300	—	—	$\mu\text{s}$	Slope of power supply that the reset detection signal generates within the rating ( $V_{DL-}$ )
Reset release delay time	$t_{d1}$	—	—	300	$\mu\text{s}$	
Reset detection delay time	$t_{d2}$	—	—	20	$\mu\text{s}$	

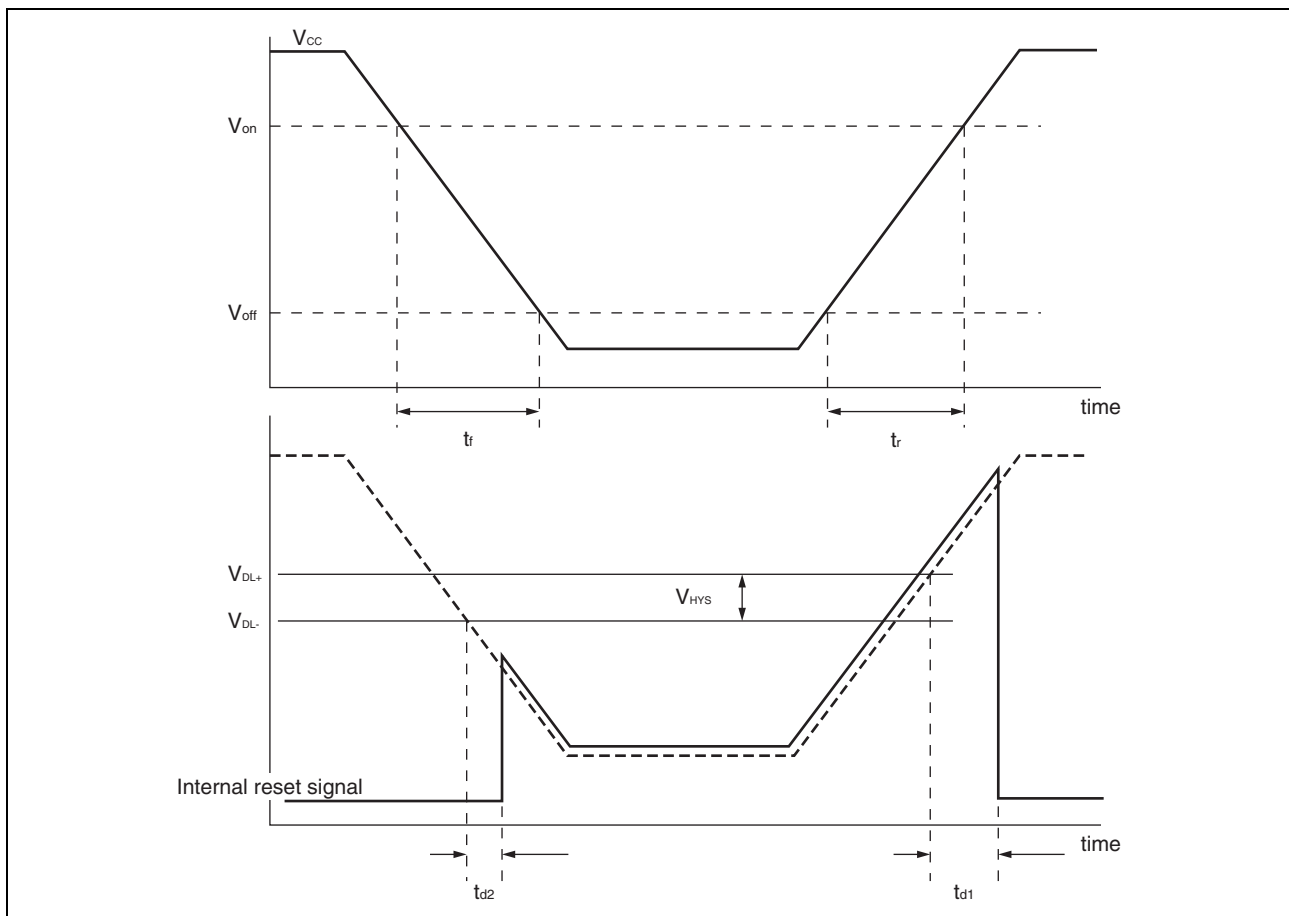

(8) I<sup>2</sup>C Timing

(V<sub>CC</sub> = 5.0 V±10%, AV<sub>SS</sub> = V<sub>SS</sub> = 0.0 V, T<sub>A</sub> = -40°C to +85°C)

Parameter	Symbol	Pin name	Condition	Value				Unit
				Standard-mode		Fast-mode		
				Min	Max	Min	Max	
SCL clock frequency	f <sub>SCL</sub>	SCL	R = 1.7 kΩ, C = 50 pF <sup>1</sup>	0	100	0	400	kHz
(Repeated) START condition hold time SDA ↓ → SCL ↓	t <sub>HD;STA</sub>	SCL, SDA		4.0	—	0.6	—	μs
SCL clock "L" width	t <sub>LOW</sub>	SCL		4.7	—	1.3	—	μs
SCL clock "H" width	t <sub>HIGH</sub>	SCL		4.0	—	0.6	—	μs
(Repeated) START condition setup time SCL ↑ → SDA ↓	t <sub>SU;STA</sub>	SCL, SDA		4.7	—	0.6	—	μs
Data hold time SCL ↓ → SDA ↓↑	t <sub>HD;DAT</sub>	SCL, SDA		0	3.45 <sup>2</sup>	0	0.9 <sup>3</sup>	μs
Data setup time SDA ↓↑ → SCL ↑	t <sub>SU;DAT</sub>	SCL, SDA		0.25	—	0.1	—	μs
STOP condition setup time SCL ↑ → SDA ↑	t <sub>SU;STO</sub>	SCL, SDA		4	—	0.6	—	μs
Bus free time between STOP condition and START condition	t <sub>BUF</sub>	SCL, SDA		4.7	—	1.3	—	μs

- \*1: R represents the pull-up resistor of the SCL and SDA lines, and C the load capacitor of the SCL and SDA lines.
- \*2: The maximum t<sub>HD;DAT</sub> in the Standard-mode is applicable only when the time during which the device is holding the SCL signal at "L" (t<sub>LOW</sub>) does not extend.
- \*3: A Fast-mode I<sup>2</sup>C-bus device can be used in a Standard-mode I<sup>2</sup>C-bus system, provided that the condition of t<sub>SU;DAT</sub> ≥ 250ns is fulfilled.

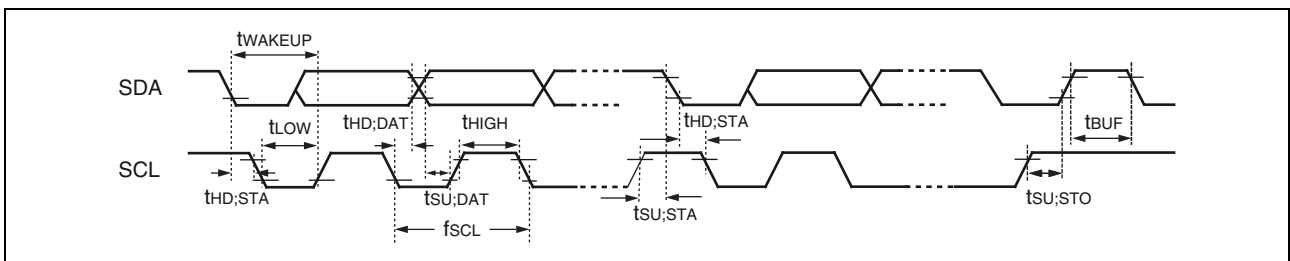

(Continued)

(V<sub>CC</sub> = 5.0 V ± 10%, AV<sub>SS</sub> = V<sub>SS</sub> = 0.0 V, T<sub>A</sub> = -40°C to +85°C)

Parameter	Symbol	Pin name	Condition	Value*2		Unit	Remarks
				Min	Max		
SCL clock "L" width	t <sub>LOW</sub>	SCL	R = 1.7 kΩ, C = 50 pF*1	$(2 + nm/2)t_{MCLK} - 20$	—	ns	Master mode
SCL clock "H" width	t <sub>HIGH</sub>	SCL		$(nm/2)t_{MCLK} - 20$	$(nm/2)t_{MCLK} + 20$	ns	Master mode
START condition hold time	t <sub>HD;STA</sub>	SCL, SDA		$(-1 + nm/2)t_{MCLK} - 20$	$(-1 + nm)t_{MCLK} + 20$	ns	Master mode Maximum value is applied when m, n = 1, 8. Otherwise, the minimum value is applied.
STOP condition setup time	t <sub>SU;STO</sub>	SCL, SDA		$(1 + nm/2)t_{MCLK} - 20$	$(1 + nm/2)t_{MCLK} + 20$	ns	Master mode
START condition setup time	t <sub>SU;STA</sub>	SCL, SDA		$(1 + nm/2)t_{MCLK} - 20$	$(1 + nm/2)t_{MCLK} + 20$	ns	Master mode
Bus free time between STOP condition and START condition	t <sub>BUF</sub>	SCL, SDA		$(2nm + 4)t_{MCLK} - 20$	—	ns	
Data hold time	t <sub>HD;DAT</sub>	SCL, SDA		$3t_{MCLK} - 20$	—	ns	Master mode
Data setup time	t <sub>SU;DAT</sub>	SCL, SDA		$(-2 + nm/2)t_{MCLK} - 20$	$(-1 + nm/2)t_{MCLK} + 20$	ns	Master mode When assuming that "L" of SCL is not extended, the minimum value is applied to first bit of continuous data. Otherwise, the maximum value is applied.
Setup time between clearing interrupt and SCL rising	t <sub>SU;INT</sub>	SCL		$(nm/2)t_{MCLK} - 20$	$(1 + nm/2)t_{MCLK} + 20$	ns	Minimum value is applied to interrupt at 9th SCL↓. Maximum value is applied to the interrupt at the 8th SCL↓.

(Continued)

(Continued)

(V<sub>CC</sub> = 5.0 V $\pm$ 10%, AV<sub>SS</sub> = V<sub>SS</sub> = 0.0 V, T<sub>A</sub> = -40°C to +85°C)

Parameter	Symbol	Pin name	Condition	Value*2		Unit	Remarks
				Min	Max		
SCL clock "L" width	t <sub>LOW</sub>	SCL	R = 1.7 k $\Omega$ , C = 50 pF*1	4 t <sub>MCLK</sub> - 20	—	ns	At reception
SCL clock "H" width	t <sub>HIGH</sub>	SCL		4 t <sub>MCLK</sub> - 20	—	ns	At reception
START condition detection	t <sub>HD;STA</sub>	SCL, SDA		2 t <sub>MCLK</sub> - 20	—	ns	Undetected when 1 t <sub>MCLK</sub> is used at reception
STOP condition detection	t <sub>SU;STO</sub>	SCL, SDA		2 t <sub>MCLK</sub> - 20	—	ns	Undetected when 1 t <sub>MCLK</sub> is used at reception
RESTART condition detection condition	t <sub>SU;STA</sub>	SCL, SDA		2 t <sub>MCLK</sub> - 20	—	ns	Undetected when 1 t <sub>MCLK</sub> is used at reception
Bus free time	t <sub>BUF</sub>	SCL, SDA		2 t <sub>MCLK</sub> - 20	—	ns	At reception
Data hold time	t <sub>HD;DAT</sub>	SCL, SDA		2 t <sub>MCLK</sub> - 20	—	ns	At slave transmission mode
Data setup time	t <sub>SU;DAT</sub>	SCL, SDA		t <sub>LOW</sub> - 3 t <sub>MCLK</sub> - 20	—	ns	At slave transmission mode
Data hold time	t <sub>HD;DAT</sub>	SCL, SDA		0	—	ns	At reception
Data setup time	t <sub>SU;DAT</sub>	SCL, SDA		t <sub>MCLK</sub> - 20	—	ns	At reception
SDA $\downarrow$ $\rightarrow$ SCL $\uparrow$ (at wakeup function)	t <sub>WAKEUP</sub>	SCL, SDA		Oscillation stabilization wait time +2 t <sub>MCLK</sub> - 20	—	ns	

\*1: R represents the pull-up resistor of the SCL and SDA lines, and C the load capacitor of the SCL and SDA lines.

\*2: • See "(2) Source Clock/Machine Clock" for t<sub>MCLK</sub>.

- m represents the CS4 bit and CS3 bit (bit4 and bit3) in the I<sup>2</sup>C clock control register (ICCR0).
- n represents the CS2 bit to CS0 bit (bit2 to bit0) in the I<sup>2</sup>C clock control register (ICCR0).
- The actual timing of I<sup>2</sup>C is determined by the values of m and n set by the machine clock (t<sub>MCLK</sub>) and the CS4 to CS0 bits in the ICCR0 register.
- Standard-mode:
  - m and n can be set to values in the following range: 0.9 MHz < t<sub>MCLK</sub> (machine clock) < 16.25 MHz.
  - The usable frequencies of the machine clock are determined by the settings of m and n as shown below.
  - (m, n) = (1, 8) : 0.9 MHz < t<sub>MCLK</sub>  $\leq$  1 MHz
  - (m, n) = (1, 22), (5, 4), (6, 4), (7, 4), (8, 4) : 0.9 MHz < t<sub>MCLK</sub>  $\leq$  2 MHz
  - (m, n) = (1, 38), (5, 8), (6, 8), (7, 8), (8, 8) : 0.9 MHz < t<sub>MCLK</sub>  $\leq$  4 MHz
  - (m, n) = (1, 98), (5, 22), (6, 22), (7, 22) : 0.9 MHz < t<sub>MCLK</sub>  $\leq$  10 MHz
  - (m, n) = (8, 22) : 0.9 MHz < t<sub>MCLK</sub>  $\leq$  16.25 MHz
- Fast-mode:
  - m and n can be set to values in the following range: 3.3 MHz < t<sub>MCLK</sub> (machine clock) < 16.25 MHz.
  - The usable frequencies of the machine clock are determined by the settings of m and n as shown below.
  - (m, n) = (1, 8) : 3.3 MHz < t<sub>MCLK</sub>  $\leq$  4 MHz
  - (m, n) = (1, 22), (5, 4) : 3.3 MHz < t<sub>MCLK</sub>  $\leq$  8 MHz
  - (m, n) = (1, 22), (6, 4), (7, 4), (8, 4) : 3.3 MHz < t<sub>MCLK</sub>  $\leq$  10 MHz
  - (m, n) = (5, 8) : 3.3 MHz < t<sub>MCLK</sub>  $\leq$  16.25 MHz

## (9) Voltage Compare Timing

( $V_{CC} = 4.0\text{ V to }5.5\text{ V}$ ,  $V_{SS} = 0.0\text{ V}$ ,  $T_A = -40^\circ\text{C to }+85^\circ\text{C}$ )

Parameter	Pin name	Value			Unit	Remarks
		Min	Typ	Max		
Voltage range	CMPn_P, CMPn_N (n = 0,1,2,3)	0	—	$V_{CC} - 1.3$	V	
Offset voltage	CMPn_P, CMPn_N (n = 0,1,2,3)	-10	—	+10	mV	
Delay time	CMPn_O (n = 0,1,2,3)	—	650	1210	ns	5 mV overdrive
		—	140	420	ns	50 mV overdrive
Power down delay	CMPn_O (n = 0,1,2,3)	—	—	1210	ns	Power down recovery PD: 1 → 0
		0	—	—	ns	Power down effective PD: 0 → 1 Output: "H" level
Power up stabilization time	CMPn_O (n = 0,1,2,3)	—	—	1210	ns	Output stabilization time at power up

## (9) Operational Amplifier Timing

- Open Loop Configuration

( $V_{CC} = 4.0\text{ V to }5.5\text{ V}$ ,  $T_A = -40^\circ\text{C to }+85^\circ\text{C}$ )

Parameter	Pin name	Value			Unit	Remarks
		Min	Typ	Max		
Input voltage range	OPAMP_P, OPAMP_N	0.1	—	1.5	V	
Output voltage range	OPAMP_O	0.1	—	$V_{CC} - 0.1$	V	
Output resistor load	OPAMP_O	220	—	—	k $\Omega$	Minimum driving resistor value
Output capacitor load	OPAMP_O	—	—	20	pF	AD loading (maximum ESR = 10k)
Offset voltage	OPAMP_O	—	—	10	mV	
Open loop bandwidth	OPAMP_O	3	—	—	MHz	
Open loop gain	OPAMP_O	75	85	—	dB	AD loading
Common mode rejection ratio	OPAMP_O	60	—	—	dB	AD loading
Power supply rejection ratio	OPAMP_O	65	—	—	dB	
Power down recovery time	OPAMP_O	—	—	200	$\mu\text{s}$	
Slew rate	OPAMP_O	0.3	—	—	V/ $\mu\text{s}$	
Large signal response	OPAMP_O	—	—	6	$\mu\text{s}$	
Small signal response	OPAMP_O	—	—	500	ns	
Output stabilization time	OPAMP_O	—	—	60	$\mu\text{s}$	After values of RES0-RES2 change

• Closed Loop Configuration

( $V_{CC} = 4.0\text{ V to }5.5\text{ V}$ ,  $T_A = -40^\circ\text{C to }+85^\circ\text{C}$ )

Parameter	Pin name	Value			Unit	Remarks
		Min	Typ	Max		
Input voltage range (10x, 20x, 60x)	OPAMP_P, OPAMP_N	0.09	—	—	V	
Input voltage range (30x, 40x, 50x)	OPAMP_P, OPAMP_N	0.10	—	—	V	
Maximum input voltage range (10x, 20x, 30x, 40x, 50x, 60x)	OPAMP_P, OPAMP_N	—	—	$V_{CC}/\text{Gain}$	V	
Output voltage range	OPAMP_O	0.1	—	$V_{CC} - 0.1$	V	
Output capacitor load	OPAMP_O	—	—	20	pF	AD loading (maximum ESR = 10k)
Closed loop bandwidth	OPAMP_O	1	—	—	MHz	AD loading
Closed loop gain	OPAMP_O	10	—	60	V/V	Selectable
Closed loop gain error* (10x, 20x, 30x, 40x, 50x)	OPAMP_O	—	—	$\pm 10\%$	—	
Closed loop gain error* (60x)	OPAMP_O	—	—	$\pm 15\%$	—	
Power down recovery time	OPAMP_O	—	—	200	$\mu\text{s}$	
Slew rate	OPAMP_O	0.3	—	—	$\text{V}/\mu\text{s}$	
Large signal response	OPAMP_O	—	—	6	$\mu\text{s}$	
Small signal response	OPAMP_O	—	—	500	ns	
Output stabilization time	OPAMP_O	—	—	60	$\mu\text{s}$	After values of RES0- RES2 change

\*: Gain error =  $1 - (\text{actual gain} / \text{design gain})$

## 5. A/D Converter

## (1) A/D Converter Electrical Characteristics

(V<sub>CC</sub> = 4.0 V to 5.5 V, V<sub>SS</sub> = 0.0 V, T<sub>A</sub> = -40°C to +85°C)

Parameter	Symbol	Value			Unit	Remarks
		Min	Typ	Max		
Resolution	—	—	—	10	bit	
Total error		-3	—	+3	LSB	
Linearity error		-2.5	—	+2.5	LSB	
Differential linear error		-1.9	—	+1.9	LSB	
Zero transition voltage	V <sub>OT</sub>	V <sub>SS</sub> - 1.5 LSB	V <sub>SS</sub> + 0.5 LSB	V <sub>SS</sub> + 2.5 LSB	V	
Full-scale transition voltage	V <sub>FST</sub>	V <sub>CC</sub> - 4.5 LSB	V <sub>CC</sub> - 2 LSB	V <sub>CC</sub> + 0.5 LSB	V	
Compare time	—	0.9	—	16500	μs	4.5 V ≤ V <sub>CC</sub> ≤ 5.5 V
		1.8	—	16500	μs	4.0 V ≤ V <sub>CC</sub> < 4.5 V
Sampling time	—	0.6	—	∞	μs	4.5 V ≤ V <sub>CC</sub> ≤ 5.5 V, with external impedance < 5.4 kΩ
		1.2	—	∞	μs	4.0 V ≤ V <sub>CC</sub> < 4.5 V, with external impedance < 2.4 kΩ
Analog input current	I <sub>AIN</sub>	-0.3	—	+0.3	μA	
Analog input voltage	V <sub>AIN</sub>	V <sub>SS</sub>	—	V <sub>CC</sub>	V	

## (2) Notes on Using the A/D Converter

### • External impedance of analog input and its sampling time

- The A/D converter has a sample and hold circuit. If the external impedance is too high to keep sufficient sampling time, the analog voltage charged to the capacitor of the internal sample and hold circuit is insufficient, adversely affecting A/D conversion precision. Therefore, to satisfy the A/D conversion precision standard, considering the relationship between the external impedance and minimum sampling time, either adjust the register value and operating frequency or decrease the external impedance so that the sampling time is longer than the minimum value. In addition, if sufficient sampling time cannot be secured, connect a capacitor of about 0.1  $\mu\text{F}$  to the analog input pin.

### • Analog input equivalent circuit

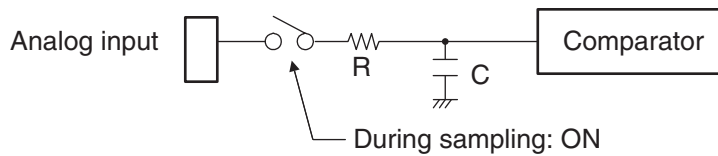

$V_{CC}$	R	C
$4.5 \text{ V} \leq V_{CC} \leq 5.5 \text{ V}$	1.95 k $\Omega$ (Max)	17 pF (Max)
$4.0 \text{ V} \leq V_{CC} < 4.5 \text{ V}$	8.98 k $\Omega$ (Max)	17 pF (Max)

Note: The values are reference values.

### • Relationship between external impedance and minimum sampling time

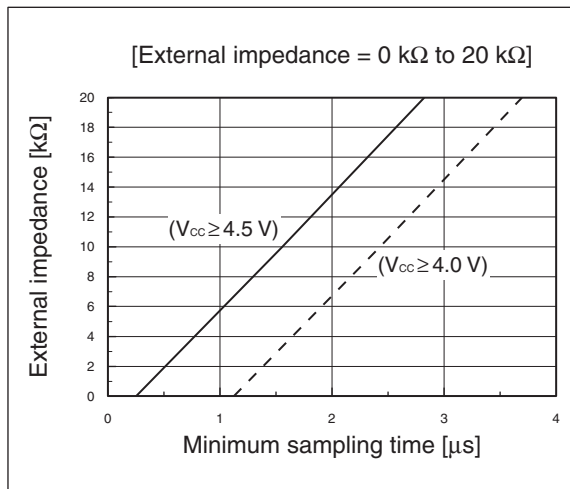
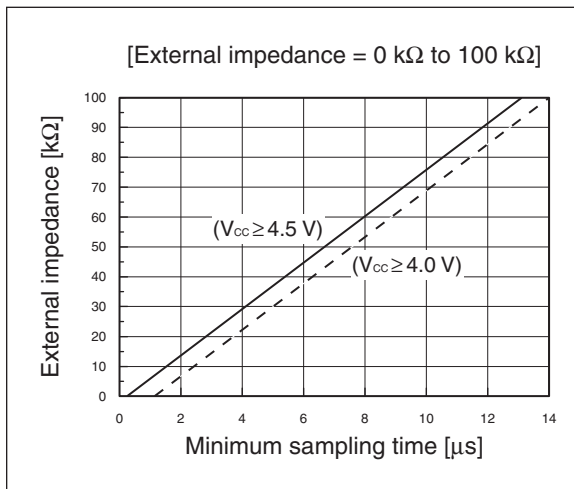

### • A/D conversion error

As  $V_{CC} - V_{SSL}$  decreases, the A/D conversion error increases proportionately.

**(3) Definitions of A/D Converter Terms**

- Resolution  
It indicates the level of analog variation that can be distinguished by the A/D converter. When the number of bits is 10, analog voltage can be divided into  $2^{10} = 1024$ .
- Linearity error (unit: LSB)  
It indicates how much an actual conversion value deviates from the straight line connecting the zero transition point (“00 0000 0000” ← → “00 0000 0001”) of a device to the full-scale transition point (“11 1111 1111” ← → “11 1111 1110”) of the same device.
- Differential linear error (unit: LSB)  
It indicates how much the input voltage required to change the output code by 1 LSB deviates from an ideal value.
- Total error (unit: LSB)  
It indicates the difference between an actual value and a theoretical value. The error can be caused by a zero transition error, a full-scale transition errors, a linearity error, a quantum error, or noise.

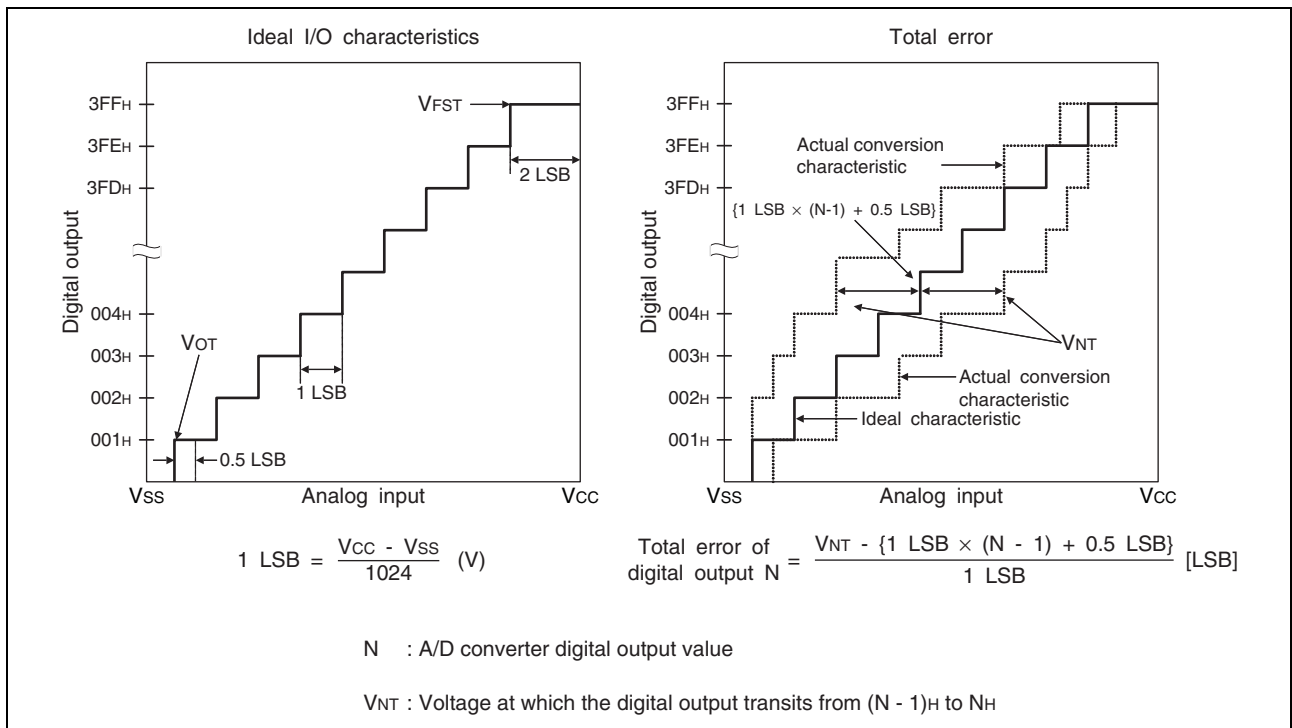

(Continued)

(Continued)

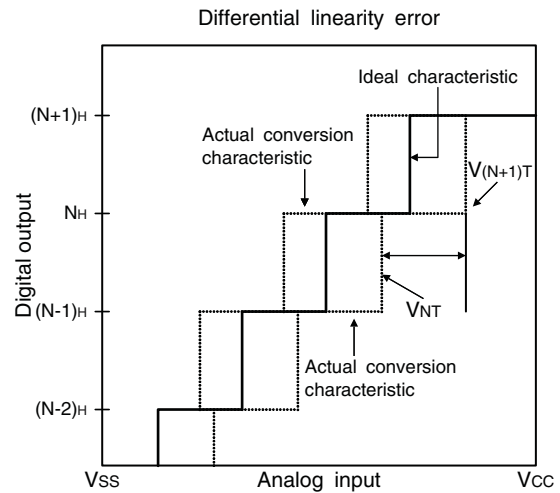
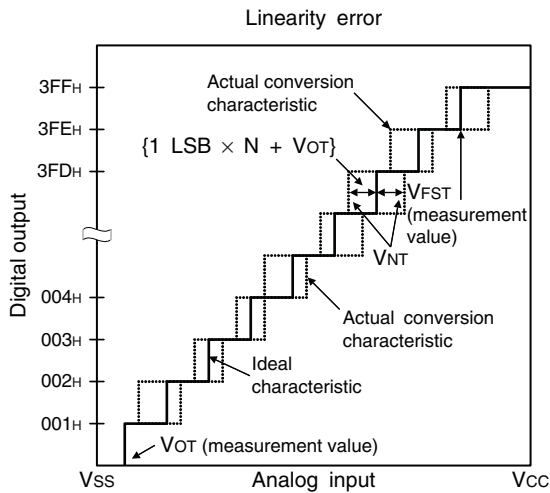
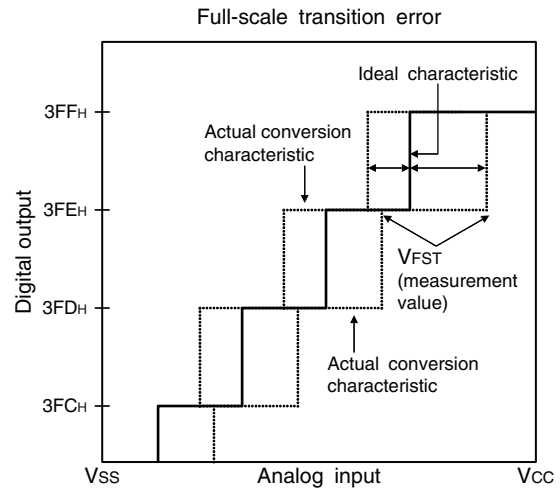
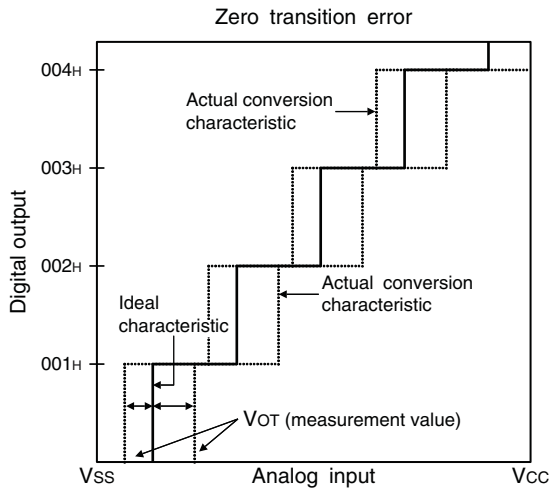

$$\text{Linearity error of digital output } N = \frac{V_{NT} - \{1 \text{ LSB} \times N + V_{OT}\}}{1 \text{ LSB}}$$

$$\text{Differential linear error of digital output } N = \frac{V_{(N+1)T} - V_{NT}}{1 \text{ LSB}} - 1$$

N : A/D converter digital output value

V<sub>NT</sub> : Voltage at which the digital output transits from (N - 1)<sub>H</sub> to N<sub>H</sub>

V<sub>OT</sub> (ideal value) = V<sub>SS</sub> + 0.5 LSB [V]

V<sub>FST</sub> (ideal value) = V<sub>CC</sub> - 2 LSB [V]

## 6. Flash Memory Program/Erase Characteristics

Parameter	Value			Unit	Remarks
	Min	Typ	Max		
Sector erase time (2 Kbyte sector)	—	0.2* <sup>1</sup>	0.5* <sup>2</sup>	s	The time of writing 00 <sub>H</sub> prior to erasure is excluded.
Sector erase time (16 Kbyte sector)	—	0.5* <sup>1</sup>	7.5* <sup>2</sup>	s	The time of writing 00 <sub>H</sub> prior to erasure is excluded.
Byte writing time	—	21	6100* <sup>2</sup>	μs	System-level overhead is excluded.
Program/erase cycle	100000	—	—	cycle	
Power supply voltage at program/erase	3.0	—	5.5	V	
Flash memory data retention time	20* <sup>3</sup>	—	—	year	Average T <sub>A</sub> = +85°C

\*1: T<sub>A</sub> = +25°C, V<sub>CC</sub> = 5.0 V, 100000 cycles

\*2: T<sub>A</sub> = +85°C, V<sub>CC</sub> = 3.0 V, 100000 cycles

\*3: This value is converted from the result of a technology reliability assessment. (The value is converted from the result of a high temperature accelerated test using the Arrhenius equation with the average temperature being +85°C).

## ■ MASK OPTIONS

No.	Part Number	MB95F432H MB95F433H MB95F434H	MB95F432K MB95F433K MB95F434K
	Selectable/Fixed	Fixed	
1	Low-voltage detection reset	Without low-voltage detection reset	With low-voltage detection reset
2	Reset	With dedicated reset input	Without dedicated reset input

## ■ ORDERING INFORMATION

Part Number	Package
MB95F432HPMC-G-SNE2 MB95F432KPMC-G-SNE2 MB95F433HPMC-G-SNE2 MB95F433KPMC-G-SNE2 MB95F434HPMC-G-SNE2 MB95F434KPMC-G-SNE2	32-pin plastic LQFP (FPT-32P-M30)
MB95F432HP-G-SH-SNE2 MB95F432KP-G-SH-SNE2 MB95F433HP-G-SH-SNE2 MB95F433KP-G-SH-SNE2 MB95F434HP-G-SH-SNE2 MB95F434KP-G-SH-SNE2	32-pin plastic SH-DIP (DIP-32P-M06)

## ■ PACKAGE DIMENSION

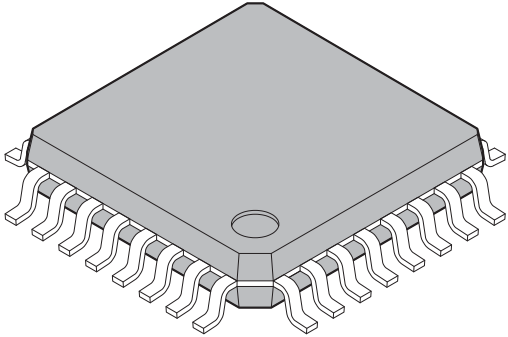
<p style="text-align: center;">32-pin plastic LQFP</p>  <p style="text-align: center;">(FPT-32P-M30)</p>	Lead pitch	0.80 mm
	Package width × package length	7.00 mm × 7.00 mm
	Lead shape	Gullwing
	Sealing method	Plastic mold
	Mounting height	1.60 mm MAX

32-pin plastic LQFP (FPT-32P-M30)

Note 1) \* : These dimensions do not include resin protrusion.  
 Note 2) Pins width and pins thickness include plating thickness.  
 Note 3) Pins width do not include tie bar cutting remainder.

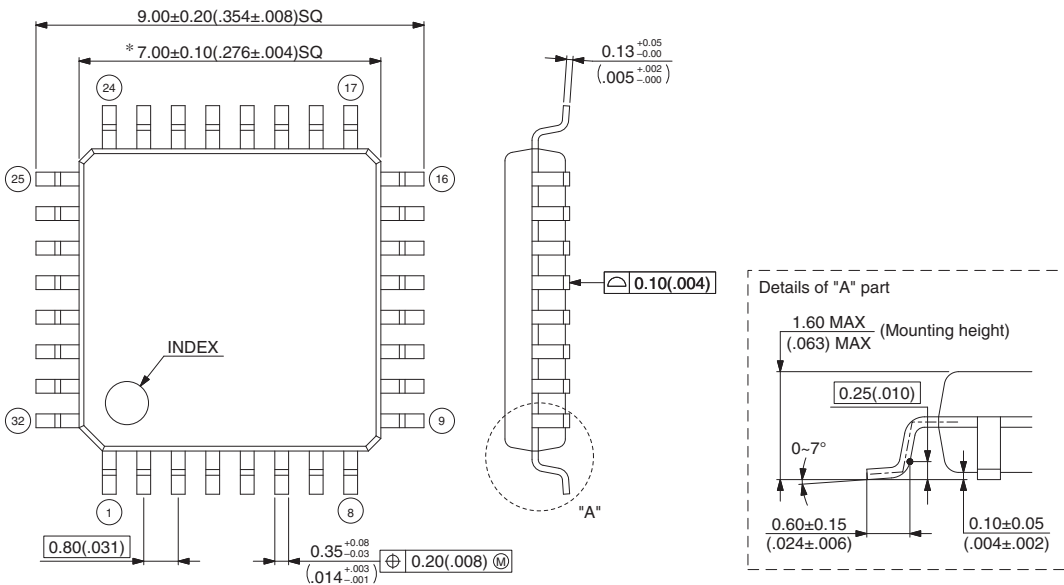

Top view dimensions:  
 Overall width:  $9.00 \pm 0.20$  ( $.354 \pm .008$ ) SQ  
 Pin pitch:  $0.80$  ( $.031$ )  
 Pin width:  $0.35$  ( $.014$ )  
 Pin thickness:  $0.13$  ( $.005$ )  
 Lead thickness:  $0.10$  ( $.004$ )  
 Lead width:  $0.25$  ( $.010$ )  
 Mounting height:  $1.60$  MAX ( $.063$ ) MAX  
 Lead angle:  $0 \sim 7^\circ$   
 Lead width at base:  $0.60 \pm 0.15$  ( $.024 \pm .006$ )  
 Lead thickness at base:  $0.10 \pm 0.05$  ( $.004 \pm .002$ )  
 Pin width:  $0.20$  ( $.008$ )

© 2009-2010 FUJITSU SEMICONDUCTOR LIMITED F32051S-c-1-2

Dimensions in mm (inches).  
 Note: The values in parentheses are reference values.

Please check the latest package dimension at the following URL.  
<http://edevic.fujitsu.com/package/en-search/>

(Continued)

(Continued)

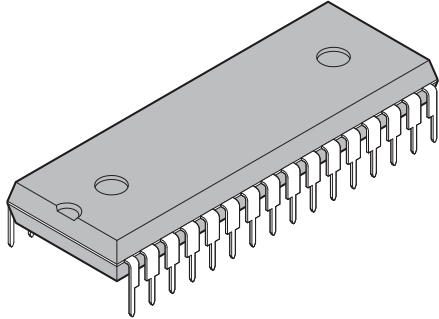
<p>32-pin plastic SDIP</p>  <p>(DIP-32P-M06)</p>	Lead pitch	1.778 mm
	Low space	10.16 mm
	Sealing method	Plastic mold

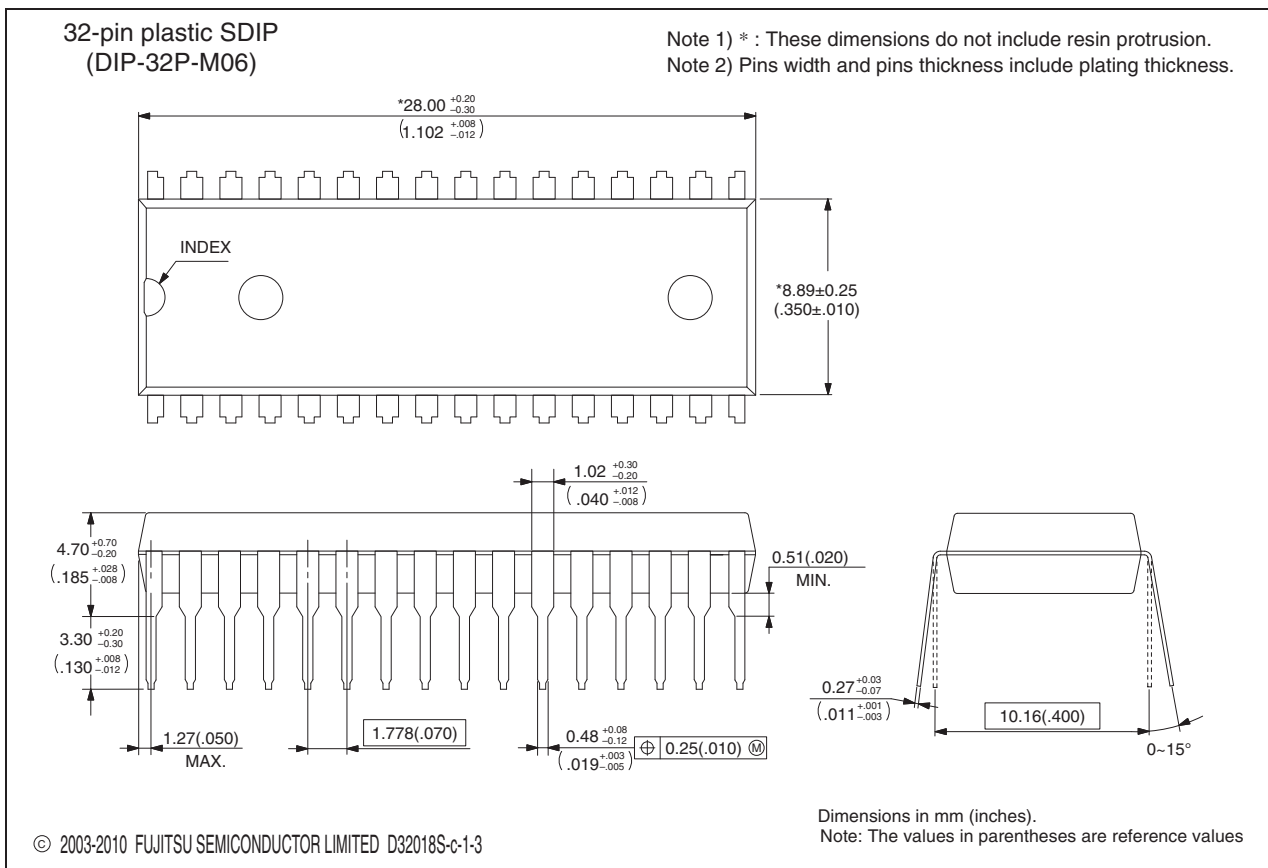

Please check the latest package dimension at the following URL.  
<http://edevice.fujitsu.com/package/en-search/>

**MEMO**

**MEMO**

A large, empty rectangular box with rounded corners, intended for writing a memo. A thin black line connects the top-left corner of this box to the 'MEMO' label.

## FUJITSU SEMICONDUCTOR LIMITED

Nomura Fudosan Shin-yokohama Bldg. 10-23, Shin-yokohama 2-Chome,  
Kohoku-ku Yokohama Kanagawa 222-0033, Japan  
Tel: +81-45-415-5858  
<http://jp.fujitsu.com/fsl/en/>

For further information please contact:

### North and South America

FUJITSU SEMICONDUCTOR AMERICA, INC.  
1250 E. Arques Avenue, M/S 333  
Sunnyvale, CA 94085-5401, U.S.A.  
Tel: +1-408-737-5600 Fax: +1-408-737-5999  
<http://us.fujitsu.com/micro/>

### Europe

FUJITSU SEMICONDUCTOR EUROPE GmbH  
Pittlerstrasse 47, 63225 Langen, Germany  
Tel: +49-6103-690-0 Fax: +49-6103-690-122  
<http://emea.fujitsu.com/semiconductor/>

### Korea

FUJITSU SEMICONDUCTOR KOREA LTD.  
206 Kosmo Tower Building, 1002 Daechi-Dong,  
Gangnam-Gu, Seoul 135-280, Republic of Korea  
Tel: +82-2-3484-7100 Fax: +82-2-3484-7111  
<http://kr.fujitsu.com/fmk/>

### Asia Pacific

FUJITSU SEMICONDUCTOR ASIA PTE. LTD.  
151 Lorong Chuan,  
#05-08 New Tech Park 556741 Singapore  
Tel : +65-6281-0770 Fax : +65-6281-0220  
<http://www.fujitsu.com/sg/services/micro/semiconductor/>

### FUJITSU SEMICONDUCTOR SHANGHAI CO., LTD.

Rm. 3102, Bund Center, No.222 Yan An Road (E),  
Shanghai 200002, China  
Tel : +86-21-6146-3688 Fax : +86-21-6335-1605  
<http://cn.fujitsu.com/fss/>

### FUJITSU SEMICONDUCTOR PACIFIC ASIA LTD.

10/F., World Commerce Centre, 11 Canton Road,  
Tsimshatsui, Kowloon, Hong Kong  
Tel : +852-2377-0226 Fax : +852-2376-3269  
<http://cn.fujitsu.com/fsp/>

Specifications are subject to change without notice. For further information please contact each office.

### All Rights Reserved.

The contents of this document are subject to change without notice.

Customers are advised to consult with sales representatives before ordering.

The information, such as descriptions of function and application circuit examples, in this document are presented solely for the purpose of reference to show examples of operations and uses of FUJITSU SEMICONDUCTOR device; FUJITSU SEMICONDUCTOR does not warrant proper operation of the device with respect to use based on such information. When you develop equipment incorporating the device based on such information, you must assume any responsibility arising out of such use of the information.

FUJITSU SEMICONDUCTOR assumes no liability for any damages whatsoever arising out of the use of the information.

Any information in this document, including descriptions of function and schematic diagrams, shall not be construed as license of the use or exercise of any intellectual property right, such as patent right or copyright, or any other right of FUJITSU SEMICONDUCTOR or any third party or does FUJITSU SEMICONDUCTOR warrant non-infringement of any third-party's intellectual property right or other right by using such information. FUJITSU SEMICONDUCTOR assumes no liability for any infringement of the intellectual property rights or other rights of third parties which would result from the use of information contained herein.

The products described in this document are designed, developed and manufactured as contemplated for general use, including without limitation, ordinary industrial use, general office use, personal use, and household use, but are not designed, developed and manufactured as contemplated (1) for use accompanying fatal risks or dangers that, unless extremely high safety is secured, could have a serious effect to the public, and could lead directly to death, personal injury, severe physical damage or other loss (i.e., nuclear reaction control in nuclear facility, aircraft flight control, air traffic control, mass transport control, medical life support system, missile launch control in weapon system), or (2) for use requiring extremely high reliability (i.e., submersible repeater and artificial satellite).

Please note that FUJITSU SEMICONDUCTOR will not be liable against you and/or any third party for any claims or damages arising in connection with above-mentioned uses of the products.

Any semiconductor devices have an inherent chance of failure. You must protect against injury, damage or loss from such failures by incorporating safety design measures into your facility and equipment such as redundancy, fire protection, and prevention of over-current levels and other abnormal operating conditions.

Exportation/release of any products described in this document may require necessary procedures in accordance with the regulations of the Foreign Exchange and Foreign Trade Control Law of Japan and/or US export control laws.

The company names and brand names herein are the trademarks or registered trademarks of their respective owners.

Edited: Sales Promotion Department

## Looking for pricing, stock, or lifecycle information?

Click below to explore more details on WIN SOURCE:

- ⊖ [View MB95F434KPMC-G-SNE2 on WIN SOURCE](#)
- ⊖ [Fujitsu Electronics America, Inc. Information](#)

## Optimize Your Supply Chain with WIN SOURCE Solutions

- ✓ Global Sourcing Solution
- ✓ Obsolete Management
- ✓ Cost Control Management
- ✓ Shortage Management
- ✓ Alternative Solution
- ✓ Excess Inventory Management