



MB95200H/210H is a series of general-purpose, single-chip microcontrollers. In addition to a compact instruction set, the microcontrollers of this series contain a variety of peripheral resources.

## Features

### F<sup>2</sup>MC-8FX CPU core

Instruction set optimized for controllers

- Multiplication and division instructions
- 16-bit arithmetic operations
- Bit test branch instructions
- Bit manipulation instructions, etc.

### Clock (main OSC clock and sub-OSC clock are only available in MB95F204H/F204K/F203H/F203K/F202H/F202K)

- Selectable main clock source
  - Main OSC clock (up to 16.25 MHz, maximum machine clock frequency: 8.125 MHz)
  - External clock (up to 32.5 MHz, maximum machine clock frequency: 16.25 MHz)
  - Main internal CR clock (1/8/10 MHz ± 3%, maximum machine clock frequency: 10 MHz)
- Selectable subclock source
  - Sub-OSC clock (32.768 kHz)
  - External clock (32.768 kHz)
  - Sub-internal CR clock (Typ: 100 kHz, Min: 50 kHz, Max: 200 kHz)

### Timer

- 8/16-bit composite timer
- Timebase timer
- Watch prescaler

### LIN-UART (MB95F204H/F204K/F203H/F203K/F202H/F202K)

- Full duplex double buffer
  - Capable of clock-synchronized serial data transfer and clock-asynchronous serial data transfer

### External interrupt

- Interrupt by edge detection (rising edge, falling edge, and both edges can be selected)
- Can be used to wake up the device from different low-power consumption (standby) modes

### 8/10-bit A/D converter

- 8-bit or 10-bit resolution can be selected.

### Low power consumption (standby) mode

- Stop mode
- Sleep mode
- Watch mode
- Timebase timer mode

### I/O port (Max: 17) (MB95F204K/F203K/F202K)

- General-purpose I/O ports (Max):  
CMOS I/O: 15, N-ch open drain: 2

### I/O port (Max: 16) (MB95F204H/F203H/F202H)

- General-purpose I/O ports (Max):  
CMOS I/O: 15, N-ch open drain: 1

### I/O port (Max: 5) (MB95F214K/F213K/F212K)

- General-purpose I/O ports (Max):  
CMOS I/O: 3, N-ch open drain: 2

### I/O port (Max: 4) (MB95F214H/F213H/F212H)

- General-purpose I/O ports (Max):  
CMOS I/O: 3, N-ch open drain: 1

### On-chip debug

- 1-wire serial control
- Serial writing supported (asynchronous mode)

### Hardware/software watchdog timer

- Built-in hardware watchdog timer

### Low-voltage detection reset circuit

- Built-in low-voltage detector

### Clock supervisor counter

- Built-in clock supervisor counter function

### Programmable port input voltage level

- CMOS input level / hysteresis input level

### Flash memory security function

- Protects the contents of flash memory

**Contents**

<b>Product Line-up</b> .....	<b>3</b>	<b>Interrupt Source Table (MB95200H Series)</b> .....	<b>26</b>
<b>Packages and Corresponding Products</b> .....	<b>4</b>	<b>Interrupt Source Table (MB95210H Series)</b> .....	<b>27</b>
<b>Differences Among Products And Notes</b>		<b>Electrical Characteristics</b> .....	<b>28</b>
<b>On Product Selection</b> .....	<b>4</b>	Absolute Maximum Ratings .....	28
<b>Pin Assignment</b> .....	<b>5</b>	Recommended Operating Conditions .....	30
<b>Pin Description (MB95200H Series 24 pins)</b> .....	<b>6</b>	DC Characteristics .....	31
<b>Pin Description (MB95200H Series 20 pins)</b> .....	<b>8</b>	AC Characteristics .....	34
<b>Pin Description (MB95210H Series)</b> .....	<b>10</b>	A/D Converter .....	49
<b>I/O Circuit Type</b> .....	<b>11</b>	Flash Memory Program/Erase Characteristics .....	53
<b>Notes on Device Handling</b> .....	<b>13</b>	<b>Sample Electrical Characteristics</b> .....	<b>54</b>
<b>Pin Connection</b> .....	<b>13</b>	<b>Mask Options</b> .....	<b>60</b>
<b>Block Diagram (MB95200H Series)</b> .....	<b>15</b>	<b>Ordering Information</b> .....	<b>60</b>
<b>Block Diagram (MB95210H Series)</b> .....	<b>16</b>	<b>Package Dimensions</b> .....	<b>61</b>
<b>CPU Core</b> .....	<b>17</b>	<b>Major Changes</b> .....	<b>65</b>
<b>I/O Map (MB95200H Series)</b> .....	<b>18</b>	<b>Document History</b> .....	<b>65</b>
<b>I/O Map (MB95210H Series)</b> .....	<b>22</b>		

**1. Product Line-up**

Part number	MB95 F204H	MB95 F203H	MB95 F202H	MB95 F204K	MB95 F203K	MB95 F202K	MB95 F214H	MB95 F213H	MB95 F212H	MB95 F214K	MB95 F213K	MB95 F212K
Type	Flash memory product											
Clock supervisor counter	It supervises the main clock oscillation.											
ROM capacity	16 KB	8 KB	4 KB	16 KB	8 KB	4 KB	16 KB	8 KB	4 KB	16 KB	8 KB	4 KB
RAM capacity	496 B	496 B	240 B	496 B	496 B	240 B	496 B	496 B	240 B	496 B	496 B	240 B
Low-voltage detection reset	No			Yes			No			Yes		
Reset input	Dedicated			Software select			Dedicated			Software select		
CPU functions	Number of basic instructions : 136 Instruction bit length : 8 bits Instruction length : 1 to 3 bytes Data bit length : 1, 8, and 16 bits Minimum instruction execution time : 61.5 ns (with machine clock = 16.25 MHz) Interrupt processing time : 0.6 μs (with machine clock = 16.25 MHz)											
General-purpose I/O	I/O ports (Max): 16 CMOS: 15, N-ch: 1			I/O ports (Max): 17 CMOS: 15, N-ch: 2			I/O ports (Max): 4 CMOS: 3, N-ch: 1			I/O ports (Max): 5 CMOS: 3, N-ch: 2		
Timebase timer	Interrupt cycle : 0.256 ms - 8.3 s (when external clock = 4 MHz)											
Hardware/software watchdog timer	Reset generation cycle Main oscillation clock at 10 MHz : 105 ms (Min) The sub-CR clock can be used as the source clock of the hardware watchdog.											
Wild register	It can be used to replace three bytes of data.											
LIN-UART	A wide range of communication speed can be selected by a dedicated reload timer. It has a full duplex double buffer. Clock-synchronized serial data transfer and clock-asynchronized serial data transfer is enabled. The LIN function can be used as a LIN master or a LIN slave.						No LIN-UART					
8/10-bit A/D converter	6 ch. 8-bit or 10-bit resolution can be selected.						2 ch.					
8/16-bit composite timer	2 ch. The timer can be configured as an "8-bit timer x 2 channels" or a "16-bit timer x 1 channel". It has built-in timer function, PWC function, PWM function and input capture function. Count clock: it can be selected from internal clocks (seven types) and external clocks. It can output square wave.						1 ch.					
External interrupt	6 ch. Interrupt by edge detection (rising edge, falling edge, or both edges can be selected.) It can be used to wake up the device from standby modes.						2 ch.					
On-chip debug	1-wire serial control It supports serial writing. (asynchronous mode)											

*(Continued)*

(Continued)

Part number / Parameter	MB95 F204H	MB95 F203H	MB95 F202H	MB95 F204K	MB95 F203K	MB95 F202K	MB95 F214H	MB95 F213H	MB95 F212H	MB95 F214K	MB95 F213K	MB95 F212K
Watch prescaler	Eight different time intervals can be selected.											
Flash memory	It supports automatic programming, Embedded Algorithm, write/erase/erase-suspend/erase-resume commands. It has a flag indicating the completion of the operation of Embedded Algorithm. Number of write/erase cycles: 100000 Data retention time: 20 years For write/erase, external Vpp(+10 V) input is required. Flash Security Feature for protecting the contents of the flash											
Standby mode	Sleep mode, stop mode, watch mode, timebase timer mode											
Package	SDIP-24 SOP-20						DIP-8 SOP-8					

## 2. Packages and Corresponding Products

Part number / Package	MB95 F204H	MB95 F203H	MB95 F202H	MB95 F204K	MB95 F203K	MB95 F202K	MB95 F214H	MB95 F213H	MB95 F212H	MB95 F214K	MB95 F213K	MB95 F212K
24-pin plastic SDIP	O	O	O	O	O	O	X	X	X	X	X	X
20-pin plastic SOP	O	O	O	O	O	O	X	X	X	X	X	X
8-pin plastic DIP	X	X	X	X	X	X	O	O	O	O	O	O
8-pin plastic SOP	X	X	X	X	X	X	O	O	O	O	O	O

O: Available

X: Unavailable

## 3. Differences Among Products And Notes On Product Selection

### Current consumption

When using the on-chip debug function, take account of the current consumption of flash erase/program.

For details of current consumption, see "18.Electrical Characteristics".

### Package

For details of information on each package, see "2.Packages and Corresponding Products" and "22.Package Dimensions".

### Operating voltage

The operating voltage varies, depending on whether the on-chip debug function is used or not.

For details of the operating voltage, see "18.Electrical Characteristics".

### On-chip debug function

The on-chip debug function requires that V<sub>CC</sub>, V<sub>SS</sub> and 1 serial-wire be connected to an evaluation tool. In addition, if the flash memory data has to be updated, the RSTX/PF2 pin must also be connected to the same evaluation tool.

**4. Pin Assignment**

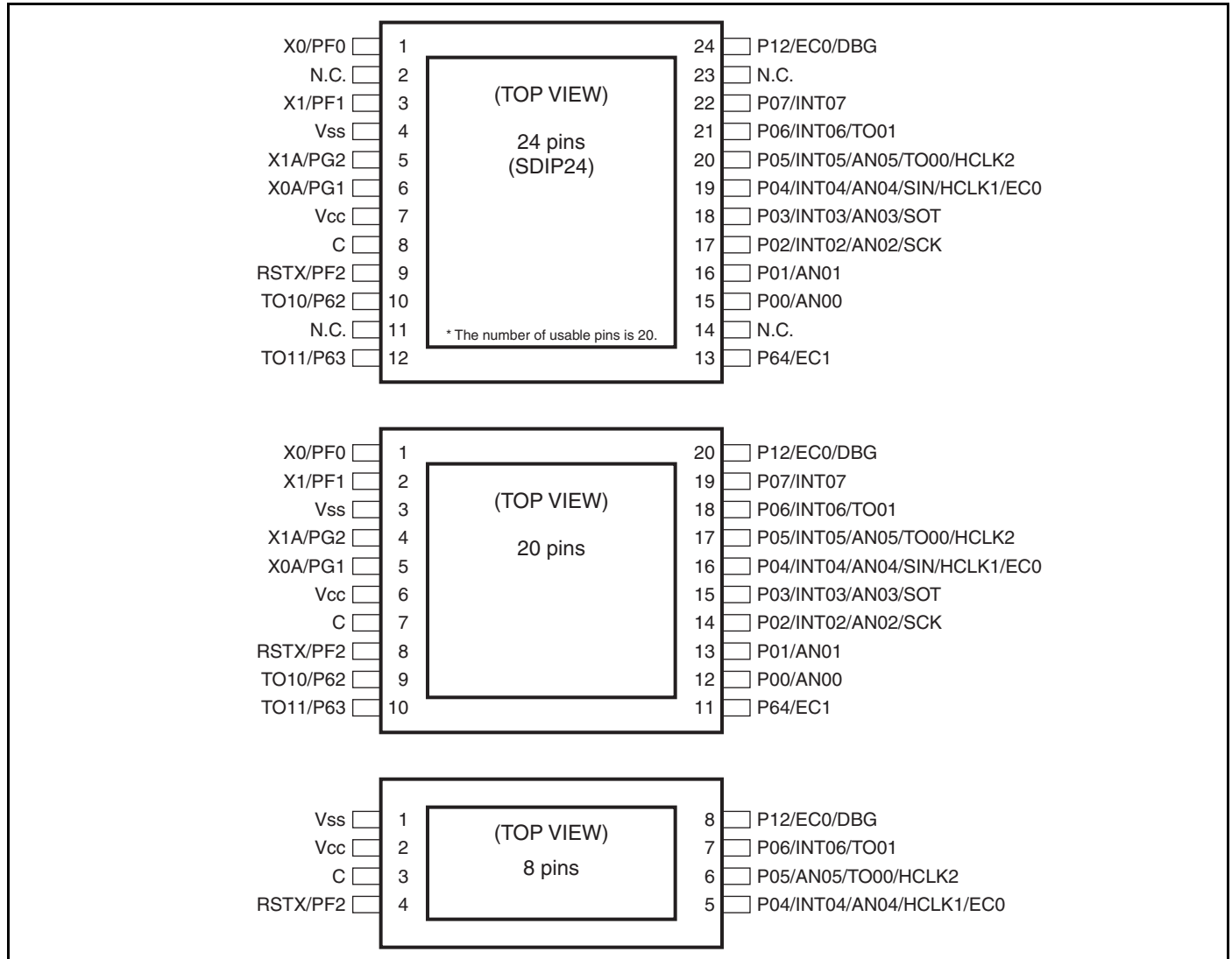

**5. Pin Description (MB95200H Series 24 pins)**

Pin no.	Pin name	I/O circuit type*	Function
1	PF0	B	General-purpose I/O port
	X0		Main clock input oscillation pin
2	N.C.	—	It is an internally unconnected pin. Always leave it unconnected.
3	PF1	B	General-purpose I/O port
	X1		Main clock I/O oscillation pin
4	V <sub>SS</sub>	—	Power supply pin (GND)
5	PG2	C	General-purpose I/O port
	X1A		Subclock I/O oscillation pin
6	PG1	C	General-purpose I/O port
	X0A		Subclock input oscillation pin
7	V <sub>CC</sub>	—	Power supply pin
8	C	—	Capacitor connection pin
9	PF2	A	General-purpose I/O port
	RSTX		Reset pin This is a dedicated reset pin in MB95F202H/F203H/F204H.
10	P62	D	General-purpose I/O port High-current port
	TO10		8/16-bit composite timer ch. 1 output pin
11	N.C.	—	It is an internally unconnected pin. Always leave it unconnected.
12	P63	D	General-purpose I/O port High-current port
	TO11		8/16-bit composite timer ch. 1 output pin
13	P64	D	General-purpose I/O port
	EC1		8/16-bit composite timer ch. 1 clock input pin
14	N.C.	—	It is an internally unconnected pin. Always leave it unconnected.
15	P00	E	General-purpose I/O port
	AN00		A/D converter analog input pin
16	P01	E	General-purpose I/O port
	AN01		A/D converter analog input pin
17	P02	E	General-purpose I/O port
	INT02		External interrupt input pin
	AN02		A/D converter analog input pin
	SCK		LIN-UART clock I/O pin

*(Continued)*

(Continued)

Pin no.	Pin name	I/O circuit type*	Function
18	P03	E	General-purpose I/O port
	INT03		External interrupt input pin
	AN03		A/D converter analog input pin
	SOT		LIN-UART data output pin
19	P04	F	General-purpose I/O port
	INT04		External interrupt input pin
	AN04		A/D converter analog input pin
	SIN		LIN-UART data input pin
	HCLK1		External clock input pin
	EC0		8/16-bit composite timer ch. 0 clock input pin
20	P05	E	General-purpose I/O port High-current port
	INT05		External interrupt input pin
	AN05		A/D converter analog input pin
	TO00		8/16-bit composite timer ch. 0 output pin
	HCLK2		External clock input pin
21	P06	G	General-purpose I/O port High-current port
	INT06		External interrupt input pin
	TO01		8/16-bit composite timer ch. 0 output pin
22	P07	G	General-purpose I/O port
	INT07		External interrupt input pin
23	N.C.	—	It is an internally unconnected pin. Always leave it unconnected.
24	P12	H	General-purpose I/O port
	EC0		8/16-bit composite timer ch. 0 clock input pin
	DBG		DBG input pin

\*: For the I/O circuit types, see "8.I/O Circuit Type".

**6. Pin Description (MB95200H Series 20 pins)**

Pin no.	Pin name	I/O circuit type*	Function
1	PF0/X0	B	General-purpose I/O port This pin is also used as the main clock input oscillation pin.
2	PF1/X1	B	General-purpose I/O port This pin is also used as the main clock input/output oscillation pin.
3	V <sub>SS</sub>	—	Power supply pin (GND)
4	PG2/X1A	C	General-purpose I/O port This pin is also used as the subclock input/output oscillation pin.
5	PG1/X0A	C	General-purpose I/O port This pin is also used as the subclock input oscillation pin.
6	V <sub>CC</sub>	—	Power supply pin
7	C	—	Capacitor connection pin
8	PF2/RSTX	A	General-purpose I/O port This pin is also used as a reset pin. This pin is a dedicated reset pin in MB95F204H/F203H/F202H.
9	P62/TO10	D	General-purpose I/O port High-current port This pin is also used as the 8/16-bit composite timer ch. 1 output.
10	P63/TO11	D	General-purpose I/O port High-current port This pin is also used as the 8/16-bit composite timer ch. 1 output.
11	P64/EC1	D	General-purpose I/O port This pin is also used as the 8/16-bit composite timer ch. 1 clock input.
12	P00/AN00	E	General-purpose I/O port This pin is also used as the A/D converter analog input.
13	P01/AN01	E	General-purpose I/O port This pin is also used as the A/D converter analog input.
14	P02/INT02/AN02/SCK	E	General-purpose I/O port This pin is also used as the external interrupt input. This pin is also used as the A/D converter analog input. This pin is also used as the LIN-UART clock I/O.
15	P03/INT03/AN03/SOT	E	General-purpose I/O port This pin is also used as the external interrupt input. This pin is also used as the A/D converter analog input. This pin is also used as the LIN-UART data output.
16	P04/INT04/AN04/SIN /HCLK1/EC0	F	General-purpose I/O port This pin is also used as the external interrupt input. This pin is also used as the A/D converter analog input. This pin is also used as the LIN-UART data input. This pin is also used as the external clock input. This pin is also used as the 8/16-bit composite timer ch. 0 clock input.

*(Continued)*

(Continued)

Pin no.	Pin name	I/O circuit type*	Function
17	P05/INT05/AN05/TO00 /HCLK2	E	General-purpose I/O port High-current port This pin is also used as the external interrupt input. This pin is also used as the A/D converter analog input. This pin is also used as the 8/16-bit composite timer ch. 0 output. This pin is also used as the external clock input.
18	P06/INT06/TO01	G	General-purpose I/O port High-current port This pin is also used as the external interrupt input. This pin is also used as the 8/16-bit composite timer ch. 0 output.
19	P07/INT07	G	General-purpose I/O port This pin is also used as the external interrupt input.
20	P12/EC0/DBG	H	General-purpose I/O port This pin is also used as the DBG input pin. This pin is also used as the 8/16-bit composite timer ch. 0 clock input.

\*: For the I/O circuit types, see "8.I/O Circuit Type"

**7. Pin Description (MB95210H Series)**

Pin no.	Pin name	I/O circuit type*	Function
1	V <sub>SS</sub>	—	Power supply pin (GND)
2	V <sub>CC</sub>	—	Power supply pin
3	C	—	Capacitor connection pin
4	RSTX/PF2	A	General-purpose I/O port This pin is also used as a reset pin. This pin is a dedicated reset pin in MB95F214H/F213H/F212H.
5	P04/INT04/AN04/HCLK1 /EC0	E	General-purpose I/O port This pin is also used as the external interrupt input. This pin is also used as the A/D converter analog input. This pin is also used as the external clock input. This pin is also used as the 8/16-bit composite timer ch. 0 clock input.
6	P05/AN05/TO00/HCLK2	E	General-purpose I/O port High-current port This pin is also used as the A/D converter analog input. This pin is also used as the 8/16-bit composite timer ch. 0 output. This pin is also used as the external clock input.
7	P06/INT06/TO01	G	General-purpose I/O port High-current port This pin is also used as the external interrupt input. This pin is also used as the 8/16-bit composite timer ch. 0 output.
8	P12/EC0/DBG	H	General-purpose I/O port This pin is also used as the DBG input pin. This pin is also used as the 8/16-bit composite timer ch. 0 clock input.

\*: For the I/O circuit types, see "8.I/O Circuit Type".

**8. I/O Circuit Type**

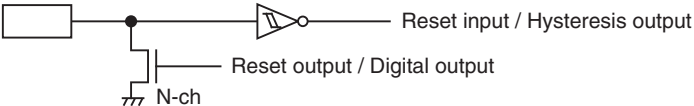
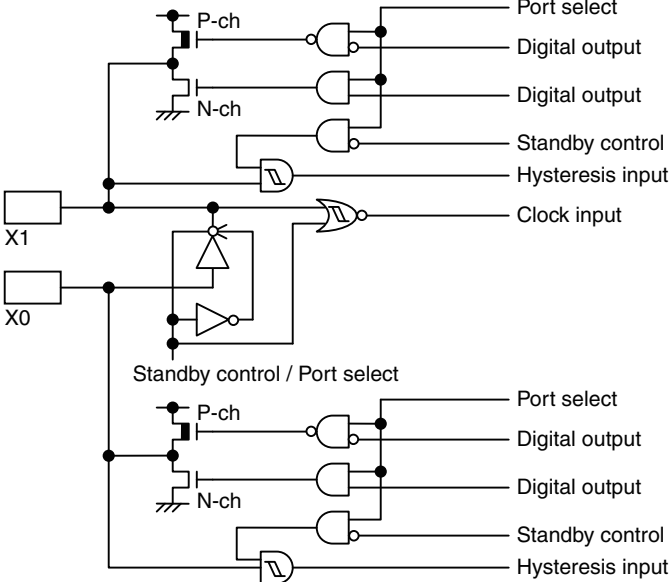
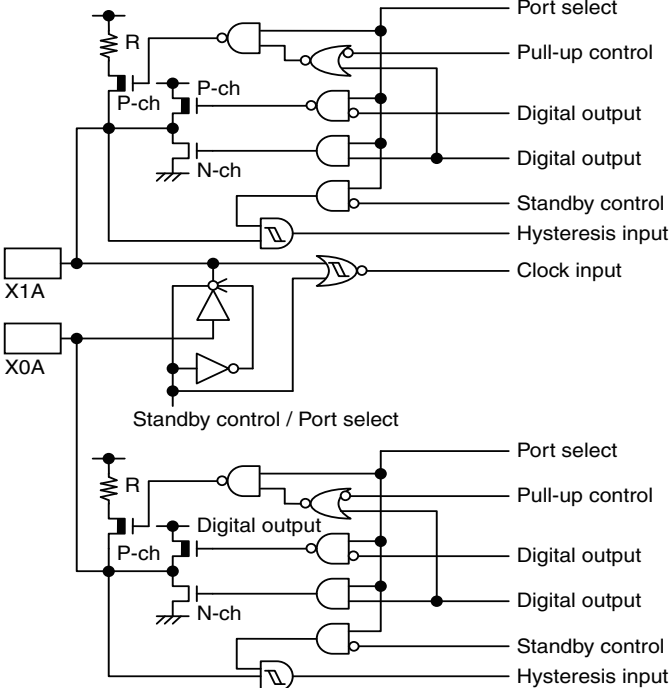
Type	Circuit	Remarks
A		<ul style="list-style-type: none"> <li>• N-ch open drain output</li> <li>• Hysteresis input</li> <li>• Reset output</li> </ul>
B		<ul style="list-style-type: none"> <li>• Oscillation circuit</li> <li>• High-speed side</li> <li>Feedback resistance: approx. 1 MΩ</li> <li>• CMOS output</li> <li>• Hysteresis input</li> </ul>
C		<ul style="list-style-type: none"> <li>• Oscillation circuit</li> <li>• Low-speed side</li> <li>Feedback resistance: approx. 10 MΩ</li> <li>• CMOS output</li> <li>• Hysteresis input</li> <li>• Pull-up control available</li> </ul>

(Continued)

(Continued)

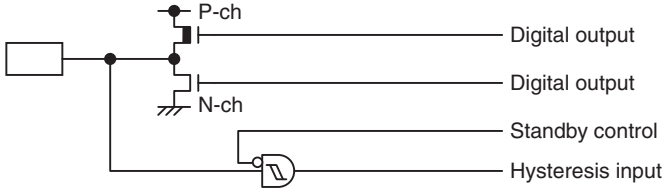
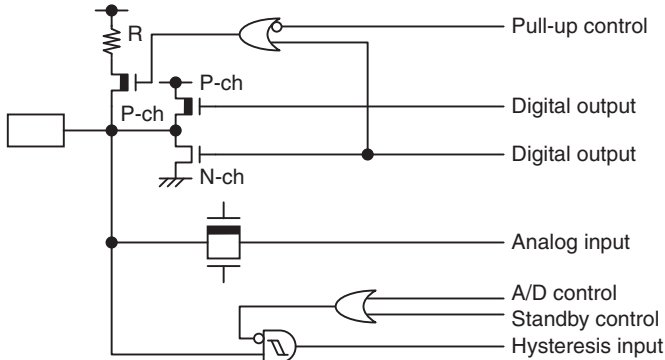
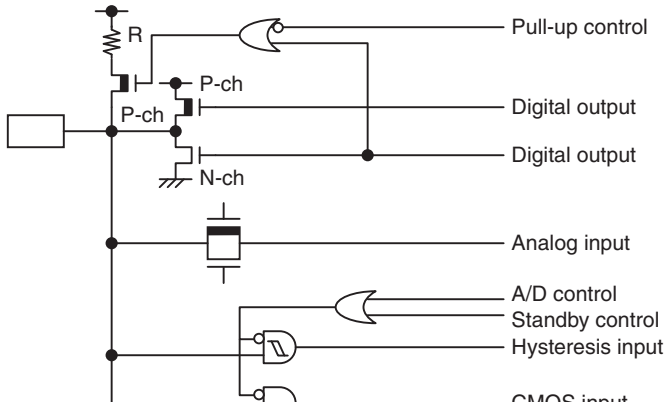
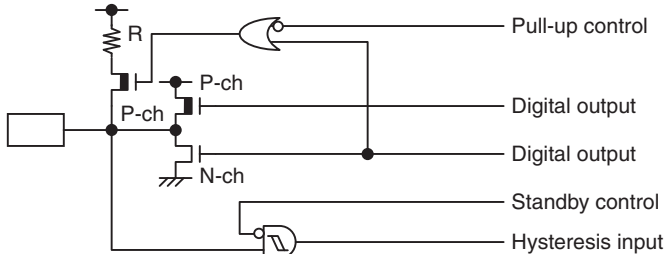
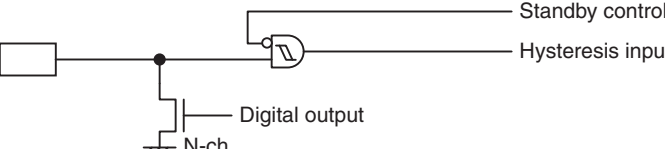
Type	Circuit	Remarks
D		<ul style="list-style-type: none"> <li>• CMOS output</li> <li>• Hysteresis input</li> </ul>
E		<ul style="list-style-type: none"> <li>• CMOS output</li> <li>• Hysteresis input</li> <li>• Pull-up control available</li> </ul>
F		<ul style="list-style-type: none"> <li>• CMOS output</li> <li>• Hysteresis input</li> <li>• CMOS input</li> <li>• Pull-up control available</li> </ul>
G		<ul style="list-style-type: none"> <li>• Hysteresis input</li> <li>• CMOS output</li> <li>• Pull-up control available</li> </ul>
H		<ul style="list-style-type: none"> <li>• N-ch open drain output</li> <li>• Hysteresis input</li> </ul>

## 9. Notes on Device Handling

### Preventing latch-ups

When using the device, ensure that the voltage applied does not exceed the maximum voltage rating.

In a CMOS IC, if a voltage higher than  $V_{CC}$  or a voltage lower than  $V_{SS}$  is applied to an input/output pin that is neither a medium-withstand voltage pin nor a high-withstand voltage pin, or if a voltage out of the rating range of power supply voltage mentioned in “18.1 Absolute Maximum Ratings” of Electrical Characteristics” is applied to the  $V_{CC}$  pin or the  $V_{SS}$  pin, a latch-up may occur.

When a latch-up occurs, power supply current increases significantly, which may cause a component to be thermally destroyed.

### Stabilizing supply voltage

Supply voltage must be stabilized.

A malfunction may occur when power supply voltage fluctuates rapidly even though the fluctuation is within the guaranteed operating range of the  $V_{CC}$  power supply voltage.

As a rule of voltage stabilization, suppress voltage fluctuation so that the fluctuation in  $V_{CC}$  ripple (p-p value) at the commercial frequency (50 Hz/60 Hz) does not exceed 10% of the standard  $V_{CC}$  value, and the transient fluctuation rate does not exceed 0.1 V/ms at a momentary fluctuation such as switching the power supply.

### Notes on using the external clock

When an external clock is used, oscillation stabilization wait time is required for power-on reset, wake-up from subclock mode or stop mode.

## 10. Pin Connection

### Treatment of unused pins

If an unused input pin is left unconnected, a component may be permanently damaged due to malfunctions or latch-ups. Always pull up or pull down an unused input pin through a resistor of at least  $2\text{ k}\Omega$ . Set an unused input/output pin to the output state and leave it unconnected, or set it to the input state and treat it the same as an unused input pin. If there is an unused output pin, leave it unconnected.

### Power supply pins

To reduce unnecessary electro-magnetic emission, prevent malfunctions of strobe signals due to an increase in the ground level, and conform to the total output current standard, always connect the  $V_{CC}$  pin and the  $V_{SS}$  pin to the power supply and ground outside the device. In addition, connect the current supply source to the  $V_{CC}$  pin and the  $V_{SS}$  pin with low impedance.

It is also advisable to connect a ceramic bypass capacitor of approximately  $0.1\ \mu\text{F}$  between the  $V_{CC}$  pin and the  $V_{SS}$  pin at a location close to this device.

### DBG pin

Connect the DBG pin directly to an external pull-up resistor.

To prevent the device from unintentionally entering the debug mode due to noise, minimize the distance between the DBG pin and the  $V_{CC}$  or  $V_{SS}$  pin when designing the layout of the printed circuit board.

The DBG pin should not stay at “L” level after power-on until the reset output is released.

### RSTX pin

Connect the RSTX pin directly to an external pull-up resistor.

To prevent the device from unintentionally entering the reset mode due to noise, minimize the distance between the RSTX pin and the  $V_{CC}$  or  $V_{SS}$  pin when designing the layout of the printed circuit board.

The RSTX/PF2 pin functions as the reset input/output pin after power-on. In addition, the reset output can be enabled by the RSTOE bit of the SYSC register, and the reset input function or the general purpose I/O function can be selected by the RSTEN bit of the SYSC register.

**C pin**

Use a ceramic capacitor or a capacitor with equivalent frequency characteristics. The bypass capacitor for the  $V_{CC}$  pin must have a capacitance larger than  $C_S$ . For the connection to a smoothing capacitor  $C_S$ , see the diagram below. To prevent the device from unintentionally entering an unknown mode due to noise, minimize the distance between the C pin and  $C_S$  and the distance between  $C_S$  and the  $V_{SS}$  pin when designing the layout of a printed circuit board.

- DBG/RSTX/C pin connection diagram

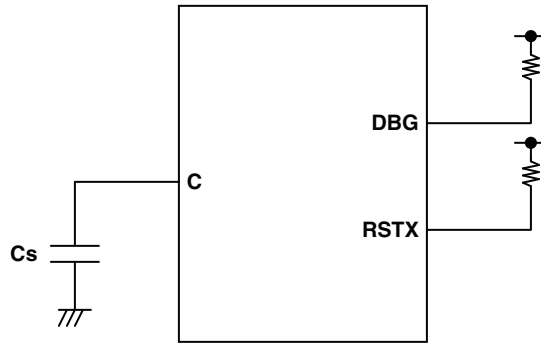

### 11. Block Diagram (MB95200H Series)

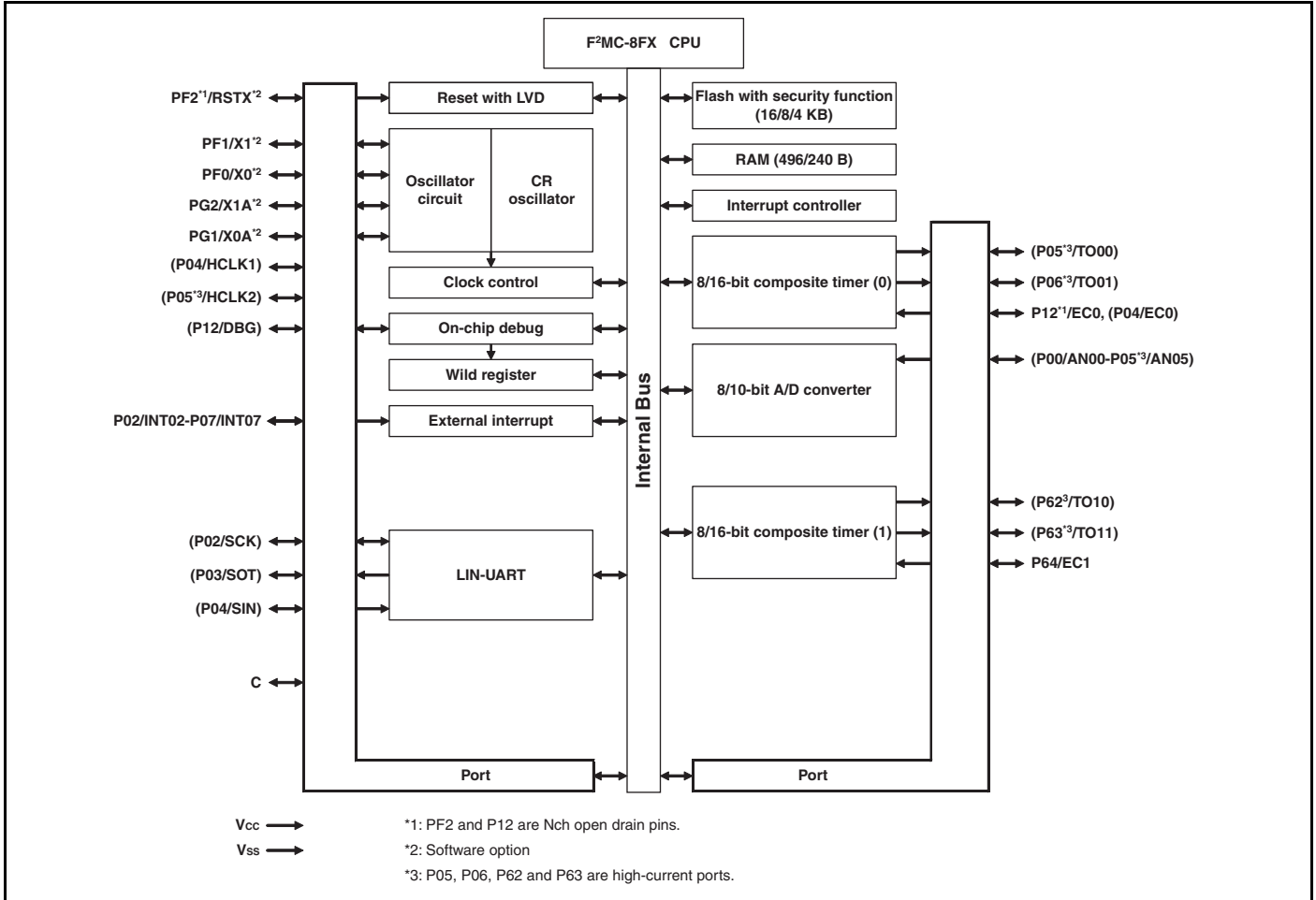

### 12. Block Diagram (MB95210H Series)

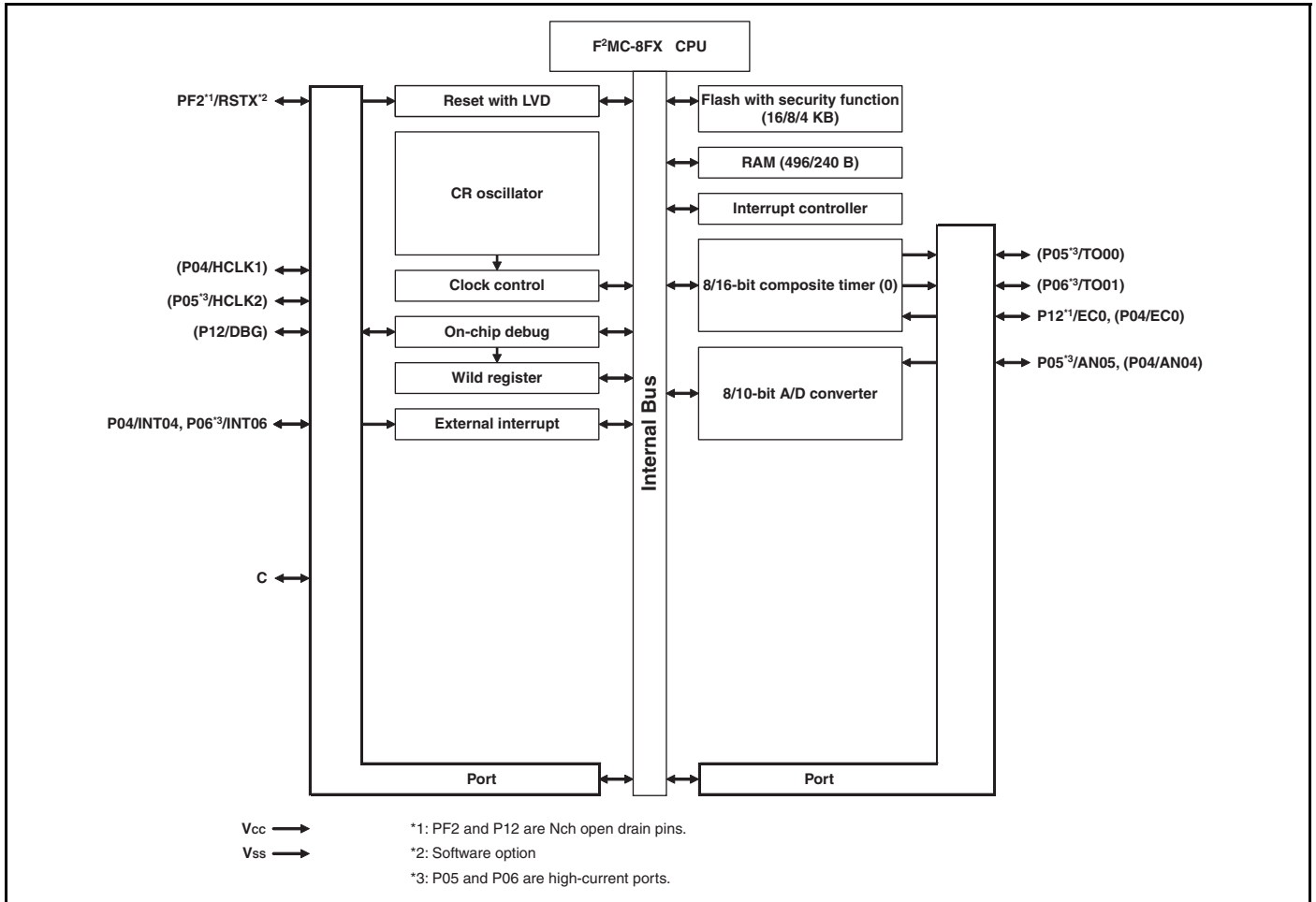

## 13. CPU Core

### Memory Space

The memory space of the MB95200H/210H Series is 64 KB in size, and consists of an I/O area, a data area, and a program area. The memory space includes areas intended for specific purposes such as general-purpose registers and a vector table. The memory maps of the MB95200H/210H Series are shown below.

#### ■ Memory Maps

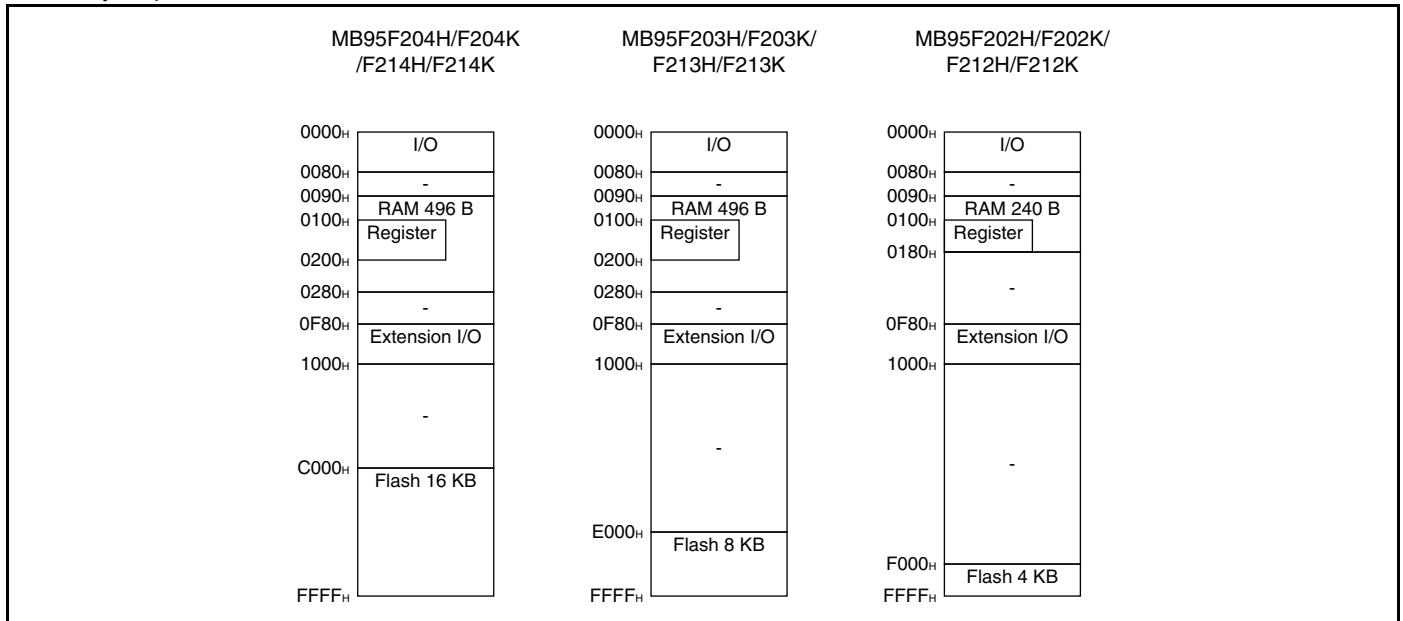

**14. I/O Map (MB95200H Series)**

Address	Register abbreviation	Register name	R/W	Initial value
0000 <sub>H</sub>	PDR0	Port 0 data register	R/W	00000000 <sub>B</sub>
0001 <sub>H</sub>	DDR0	Port 0 direction register	R/W	00000000 <sub>B</sub>
0002 <sub>H</sub>	PDR1	Port 1 data register	R/W	00000000 <sub>B</sub>
0003 <sub>H</sub>	DDR1	Port 1 direction register	R/W	00000000 <sub>B</sub>
0004 <sub>H</sub>	—	(Disabled)	—	—
0005 <sub>H</sub>	WATR	Oscillation stabilization wait time setting register	R/W	11111111 <sub>B</sub>
0006 <sub>H</sub>	—	(Disabled)	—	—
0007 <sub>H</sub>	SYCC	System clock control register	R/W	XXXXXX11 <sub>B</sub>
0008 <sub>H</sub>	STBC	Standby control register	R/W	0000XXX <sub>B</sub>
0009 <sub>H</sub>	RSRR	Reset source register	R	XXXXXXXX <sub>B</sub>
000A <sub>H</sub>	TBTC	Timebase timer control register	R/W	00000000 <sub>B</sub>
000B <sub>H</sub>	WPCR	Watch prescaler control register	R/W	00000000 <sub>B</sub>
000C <sub>H</sub>	WDTC	Watchdog timer control register	R/W	00000000 <sub>B</sub>
000D <sub>H</sub>	SYCC2	System clock control register 2	R/W	XX100011 <sub>B</sub>
000E <sub>H</sub> to 0015 <sub>H</sub>	—	(Disabled)	—	—
0016 <sub>H</sub>	PDR6	Port 6 data register	R/W	00000000 <sub>B</sub>
0017 <sub>H</sub>	DDR6	Port 6 direction register	R/W	00000000 <sub>B</sub>
0018 <sub>H</sub> to 0027 <sub>H</sub>	—	(Disabled)	—	—
0028 <sub>H</sub>	PDRF	Port F data register	R/W	00000000 <sub>B</sub>
0029 <sub>H</sub>	DDRF	Port F direction register	R/W	00000000 <sub>B</sub>
002A <sub>H</sub>	PDRG	Port G data register	R/W	00000000 <sub>B</sub>
002B <sub>H</sub>	DDRG	Port G direction register	R/W	00000000 <sub>B</sub>
002C <sub>H</sub>	PUL0	Port 0 pull-up register	R/W	00000000 <sub>B</sub>
002D <sub>H</sub> to 0034 <sub>H</sub>	—	(Disabled)	—	—
0035 <sub>H</sub>	PULG	Port G pull-up register	R/W	00000000 <sub>B</sub>
0036 <sub>H</sub>	T01CR1	8/16-bit composite timer 01 status control register 1 ch. 0	R/W	00000000 <sub>B</sub>
0037 <sub>H</sub>	T00CR1	8/16-bit composite timer 00 status control register 1 ch. 0	R/W	00000000 <sub>B</sub>
0038 <sub>H</sub>	T11CR1	8/16-bit composite timer 11 status control register 1 ch. 1	R/W	00000000 <sub>B</sub>
0039 <sub>H</sub>	T10CR1	8/16-bit composite timer 10 status control register 1 ch. 1	R/W	00000000 <sub>B</sub>
003A <sub>H</sub> to 0048 <sub>H</sub>	—	(Disabled)	—	—
0049 <sub>H</sub>	EIC10	External interrupt circuit control register ch. 2/ch. 3	R/W	00000000 <sub>B</sub>

*(Continued)*

Address	Register abbreviation	Register name	R/W	Initial value
004A <sub>H</sub>	EIC20	External interrupt circuit control register ch. 4/ch. 5	R/W	00000000 <sub>B</sub>
004B <sub>H</sub>	EIC30	External interrupt circuit control register ch. 6/ch. 7	R/W	00000000 <sub>B</sub>
004C <sub>H</sub> to 004F <sub>H</sub>	—	(Disabled)	—	—
0050 <sub>H</sub>	SCR	LIN-UART serial control register	R/W	00000000 <sub>B</sub>
0051 <sub>H</sub>	SMR	LIN-UART serial mode register	R/W	00000000 <sub>B</sub>
0052 <sub>H</sub>	SSR	LIN-UART serial status register	R/W	00001000 <sub>B</sub>
0053 <sub>H</sub>	RDR/TDR	LIN-UART receive/transmit data register	R/W	00000000 <sub>B</sub>
0054 <sub>H</sub>	ESCR	LIN-UART extended status control register	R/W	00000100 <sub>B</sub>
0055 <sub>H</sub>	ECCR	LIN-UART extended communication control register	R/W	000000XX <sub>B</sub>
0056 <sub>H</sub> to 006B <sub>H</sub>	—	(Disabled)	—	—
006C <sub>H</sub>	ADC1	8/10-bit A/D converter control register 1	R/W	00000000 <sub>B</sub>
006D <sub>H</sub>	ADC2	8/10-bit A/D converter control register 2	R/W	00000000 <sub>B</sub>
006E <sub>H</sub>	ADDH	8/10-bit A/D converter data register (Upper)	R/W	00000000 <sub>B</sub>
006F <sub>H</sub>	ADDL	8/10-bit A/D converter data register (Lower)	R/W	00000000 <sub>B</sub>
0070 <sub>H</sub> to 0071 <sub>H</sub>	—	(Disabled)	—	—
0072 <sub>H</sub>	FSR	Flash memory status register	R/W	000X0000 <sub>B</sub>
0073 <sub>H</sub> to 0075 <sub>H</sub>	—	(Disabled)	—	—
0076 <sub>H</sub>	WREN	Wild register address compare enable register	R/W	00000000 <sub>B</sub>
0077 <sub>H</sub>	WROR	Wild register data test setting register	R/W	00000000 <sub>B</sub>
0078 <sub>H</sub>	—	Mirror of register bank pointer (RP) and direct bank pointer (DP)	—	—
0079 <sub>H</sub>	ILR0	Interrupt level setting register 0	R/W	11111111 <sub>B</sub>
007A <sub>H</sub>	ILR1	Interrupt level setting register 1	R/W	11111111 <sub>B</sub>
007B <sub>H</sub>	ILR2	Interrupt level setting register 2	R/W	11111111 <sub>B</sub>
007C <sub>H</sub>	ILR3	Interrupt level setting register 3	R/W	11111111 <sub>B</sub>
007D <sub>H</sub>	ILR4	Interrupt level setting register 4	R/W	11111111 <sub>B</sub>
007E <sub>H</sub>	ILR5	Interrupt level setting register 5	R/W	11111111 <sub>B</sub>
007F <sub>H</sub>	—	(Disabled)	—	—
0F80 <sub>H</sub>	WRARH0	Wild register address setting register (Upper) ch. 0	R/W	00000000 <sub>B</sub>

*(Continued)*

Address	Register abbreviation	Register name	R/W	Initial value
0F81 <sub>H</sub>	WRARL0	Wild register address setting register (Lower) ch. 0	R/W	00000000 <sub>B</sub>
0F82 <sub>H</sub>	WRDR0	Wild register data setting register ch. 0	R/W	00000000 <sub>B</sub>
0F83 <sub>H</sub>	WRARH1	Wild register address setting register (Upper) ch. 1	R/W	00000000 <sub>B</sub>
0F84 <sub>H</sub>	WRARL1	Wild register address setting register (Lower) ch. 1	R/W	00000000 <sub>B</sub>
0F85 <sub>H</sub>	WRDR1	Wild register data setting register ch. 1	R/W	00000000 <sub>B</sub>
0F86 <sub>H</sub>	WRARH2	Wild register address setting register (Upper) ch. 2	R/W	00000000 <sub>B</sub>
0F87 <sub>H</sub>	WRARL2	Wild register address setting register (Lower) ch. 2	R/W	00000000 <sub>B</sub>
0F88 <sub>H</sub>	WRDR2	Wild register data setting register ch. 2	R/W	00000000 <sub>B</sub>
0F89 <sub>H</sub> to 0F91 <sub>H</sub>	—	(Disabled)	—	—
0F92 <sub>H</sub>	T01CR0	8/16-bit composite timer 01 status control register 0 ch. 0	R/W	00000000 <sub>B</sub>
0F93 <sub>H</sub>	T00CR0	8/16-bit composite timer 00 status control register 0 ch. 0	R/W	00000000 <sub>B</sub>
0F94 <sub>H</sub>	T01DR	8/16-bit composite timer 01 data register ch. 0	R/W	00000000 <sub>B</sub>
0F95 <sub>H</sub>	T00DR	8/16-bit composite timer 00 data register ch. 0	R/W	00000000 <sub>B</sub>
0F96 <sub>H</sub>	TMCR0	8/16-bit composite timer 00/01 timer mode control register ch. 0	R/W	00000000 <sub>B</sub>
0F97 <sub>H</sub>	T11CR0	8/16-bit composite timer 11 status control register 0 ch. 1	R/W	00000000 <sub>B</sub>
0F98 <sub>H</sub>	T10CR0	8/16-bit composite timer 10 status control register 0 ch. 1	R/W	00000000 <sub>B</sub>
0F99 <sub>H</sub>	T11DR	8/16-bit composite timer 11 data register ch. 1	R/W	00000000 <sub>B</sub>
0F9A <sub>H</sub>	T10DR	8/16-bit composite timer 10 data register ch. 1	R/W	00000000 <sub>B</sub>
0F9B <sub>H</sub>	TMCR1	8/16-bit composite timer 10/11 timer mode control register ch. 1	R/W	00000000 <sub>B</sub>
0F9C <sub>H</sub> to 0FBB <sub>H</sub>	—	(Disabled)	—	—
0FBC <sub>H</sub>	BGR1	LIN-UART baud rate generator register 1	R/W	00000000 <sub>B</sub>
0FBD <sub>H</sub>	BGR0	LIN-UART baud rate generator register 0	R/W	00000000 <sub>B</sub>
0FBE <sub>H</sub> to 0FC2 <sub>H</sub>	—	(Disabled)	—	—
0FC3 <sub>H</sub>	AIDRL	A/D input disable register (Lower)	R/W	00000000 <sub>B</sub>
0FC4 <sub>H</sub> to 0FE3 <sub>H</sub>	—	(Disabled)	—	—
0FE4 <sub>H</sub>	CRTH	Main CR clock trimming register (Upper)	R/W	1XXXXXXX <sub>B</sub>
0FE5 <sub>H</sub>	CRTL	Main CR clock trimming register (Lower)	R/W	000XXXXX <sub>B</sub>

*(Continued)*

(Continued)

Address	Register abbreviation	Register name	R/W	Initial value
0FE6 <sub>H</sub> to 0FE7 <sub>H</sub>	—	(Disabled)	—	—
0FE8 <sub>H</sub>	SYSC	System configuration register	R/W	11000011 <sub>B</sub>
0FE9 <sub>H</sub>	CMCR	Clock monitoring control register	R/W	XX000000 <sub>B</sub>
0FEA <sub>H</sub>	CMDR	Clock monitoring data register	R/W	00000000 <sub>B</sub>
0FEB <sub>H</sub>	WDTH	Watchdog timer selection ID register (Upper)	R/W	XXXXXXXX <sub>B</sub>
0FEC <sub>H</sub>	WDTL	Watchdog timer selection ID register (Lower)	R/W	XXXXXXXX <sub>B</sub>
0FED <sub>H</sub>	—	(Disabled)	—	—
0FEE <sub>H</sub>	ILSR	Input level select register	R/W	00000000 <sub>B</sub>
0FEF <sub>H</sub> to 0FFF <sub>H</sub>	—	(Disabled)	—	—

**R/W access symbols**

R/W : Readable / Writable

R : Read only

W : Write only

**Initial value symbols**

0 : The initial value of this bit is “0”.

1 : The initial value of this bit is “1”.

X : The initial value of this bit is undefined.

Note: Do not write to an address that is “(Disabled)”. If a “(Disabled)” address is read, an undefined value is returned.

**15. I/O Map (MB95210H Series)**

Address	Register abbreviation	Register name	R/W	Initial value
0000 <sub>H</sub>	PDR0	Port 0 data register	R/W	00000000 <sub>B</sub>
0001 <sub>H</sub>	DDR0	Port 0 direction register	R/W	00000000 <sub>B</sub>
0002 <sub>H</sub>	PDR1	Port 1 data register	R/W	00000000 <sub>B</sub>
0003 <sub>H</sub>	DDR1	Port 1 direction register	R/W	00000000 <sub>B</sub>
0004 <sub>H</sub>	—	(Disabled)	—	—
0005 <sub>H</sub>	WATR	Oscillation stabilization wait time setting register	R/W	11111111 <sub>B</sub>
0006 <sub>H</sub>	—	(Disabled)	—	—
0007 <sub>H</sub>	SYCC	System clock control register	R/W	XXXXXXXX11 <sub>B</sub>
0008 <sub>H</sub>	STBC	Standby control register	R/W	00000XXX <sub>B</sub>
0009 <sub>H</sub>	RSRR	Reset source register	R	XXXXXXXXXX <sub>B</sub>
000A <sub>H</sub>	TBTC	Timebase timer control register	R/W	00000000 <sub>B</sub>
000B <sub>H</sub>	WPCR	Watch prescaler control register	R/W	00000000 <sub>B</sub>
000C <sub>H</sub>	WDTC	Watchdog timer control register	R/W	00000000 <sub>B</sub>
000D <sub>H</sub>	SYCC2	System clock control register 2	R/W	XX100011 <sub>B</sub>
000E <sub>H</sub> to 0015 <sub>H</sub>	—	(Disabled)	—	—
0016 <sub>H</sub>	—	(Disabled)	—	—
0017 <sub>H</sub>	—	(Disabled)	—	—
0018 <sub>H</sub> to 0027 <sub>H</sub>	—	(Disabled)	—	—
0028 <sub>H</sub>	PDRF	Port F data register	R/W	00000000 <sub>B</sub>
0029 <sub>H</sub>	DDRF	Port F direction register	R/W	00000000 <sub>B</sub>
002A <sub>H</sub>	—	(Disabled)	—	—
002B <sub>H</sub>	—	(Disabled)	—	—
002C <sub>H</sub>	PUL0	Port 0 pull-up register	R/W	00000000 <sub>B</sub>
002D <sub>H</sub> to 0034 <sub>H</sub>	—	(Disabled)	—	—
0035 <sub>H</sub>	—	(Disabled)	—	—
0036 <sub>H</sub>	T01CR1	8/16-bit composite timer 01 status control register 1 ch. 0	R/W	00000000 <sub>B</sub>
0037 <sub>H</sub>	T00CR1	8/16-bit composite timer 00 status control register 1 ch. 0	R/W	00000000 <sub>B</sub>
0038 <sub>H</sub>	—	(Disabled)	—	—
0039 <sub>H</sub>	—	(Disabled)	—	—
003A <sub>H</sub> to 0048 <sub>H</sub>	—	(Disabled)	—	—
0049 <sub>H</sub>	—	(Disabled)	—	—

*(Continued)*

Address	Register abbreviation	Register name	R/W	Initial value
004A <sub>H</sub>	EIC20	External interrupt circuit control register ch. 4	R/W	00000000 <sub>B</sub>
004B <sub>H</sub>	EIC30	External interrupt circuit control register ch. 6	R/W	00000000 <sub>B</sub>
004C <sub>H</sub> to 004F <sub>H</sub>	—	(Disabled)	—	—
0050 <sub>H</sub>	—	(Disabled)	—	—
0051 <sub>H</sub>	—	(Disabled)	—	—
0052 <sub>H</sub>	—	(Disabled)	—	—
0053 <sub>H</sub>	—	(Disabled)	—	—
0054 <sub>H</sub>	—	(Disabled)	—	—
0055 <sub>H</sub>	—	(Disabled)	—	—
0056 <sub>H</sub> to 006B <sub>H</sub>	—	(Disabled)	—	—
006C <sub>H</sub>	ADC1	8/10-bit A/D converter control register 1	R/W	00000000 <sub>B</sub>
006D <sub>H</sub>	ADC2	8/10-bit A/D converter control register 2	R/W	00000000 <sub>B</sub>
006E <sub>H</sub>	ADDH	8/10-bit A/D converter data register (Upper)	R/W	00000000 <sub>B</sub>
006F <sub>H</sub>	ADDL	8/10-bit A/D converter data register (Lower)	R/W	00000000 <sub>B</sub>
0070 <sub>H</sub> to 0071 <sub>H</sub>	—	(Disabled)	—	—
0072 <sub>H</sub>	FSR	Flash memory status register	R/W	000X0000 <sub>B</sub>
0073 <sub>H</sub> to 0075 <sub>H</sub>	—	(Disabled)	—	—
0076 <sub>H</sub>	WREN	Wild register address compare enable register	R/W	00000000 <sub>B</sub>
0077 <sub>H</sub>	WROR	Wild register data test setting register	R/W	00000000 <sub>B</sub>
0078 <sub>H</sub>	—	Mirror of register bank pointer (RP) and direct bank pointer (DP)	—	—
0079 <sub>H</sub>	ILR0	Interrupt level setting register 0	R/W	11111111 <sub>B</sub>
007A <sub>H</sub>	ILR1	Interrupt level setting register 1	R/W	11111111 <sub>B</sub>
007B <sub>H</sub>	—	(Disabled)	—	—
007C <sub>H</sub>	—	(Disabled)	—	—
007D <sub>H</sub>	ILR4	Interrupt level setting register 4	R/W	11111111 <sub>B</sub>
007E <sub>H</sub>	ILR5	Interrupt level setting register 5	R/W	11111111 <sub>B</sub>
007F <sub>H</sub>	—	(Disabled)	—	—
0F80 <sub>H</sub>	WRARH0	Wild register address setting register (Upper) ch. 0	R/W	00000000 <sub>B</sub>
0F81 <sub>H</sub>	WRARL0	Wild register address setting register (Lower) ch. 0	R/W	00000000 <sub>B</sub>
0F82 <sub>H</sub>	WRDR0	Wild register data setting register ch. 0	R/W	00000000 <sub>B</sub>

*(Continued)*

Address	Register abbreviation	Register name	R/W	Initial value
0F83 <sub>H</sub>	WRARH1	Wild register address setting register (Upper) ch. 1	R/W	00000000 <sub>B</sub>
0F84 <sub>H</sub>	WRARL1	Wild register address setting register (Lower) ch. 1	R/W	00000000 <sub>B</sub>
0F85 <sub>H</sub>	WRDR1	Wild register data setting register ch. 1	R/W	00000000 <sub>B</sub>
0F86 <sub>H</sub>	WRARH2	Wild register address setting register (Upper) ch. 2	R/W	00000000 <sub>B</sub>
0F87 <sub>H</sub>	WRARL2	Wild register address setting register (Lower) ch. 2	R/W	00000000 <sub>B</sub>
0F88 <sub>H</sub>	WRDR2	Wild register data setting register ch. 2	R/W	00000000 <sub>B</sub>
0F89 <sub>H</sub> to 0F91 <sub>H</sub>	—	(Disabled)	—	—
0F92 <sub>H</sub>	T01CR0	8/16-bit composite timer 01 status control register 0 ch. 0	R/W	00000000 <sub>B</sub>
0F93 <sub>H</sub>	T00CR0	8/16-bit composite timer 00 status control register 0 ch. 0	R/W	00000000 <sub>B</sub>
0F94 <sub>H</sub>	T01DR	8/16-bit composite timer 01 data register ch. 0	R/W	00000000 <sub>B</sub>
0F95 <sub>H</sub>	T00DR	8/16-bit composite timer 00 data register ch. 0	R/W	00000000 <sub>B</sub>
0F96 <sub>H</sub>	TMCR0	8/16-bit composite timer 00/01 timer mode control register ch. 0	R/W	00000000 <sub>B</sub>
0F97 <sub>H</sub>	—	(Disabled)	—	—
0F98 <sub>H</sub>	—	(Disabled)	—	—
0F99 <sub>H</sub>	—	(Disabled)	—	—
0F9A <sub>H</sub>	—	(Disabled)	—	—
0F9B <sub>H</sub>	—	(Disabled)	—	—
0F9C <sub>H</sub> to 0FBB <sub>H</sub>	—	(Disabled)	—	—
0FBC <sub>H</sub>	—	(Disabled)	—	—
0FBD <sub>H</sub>	—	(Disabled)	—	—
0FBE <sub>H</sub> to 0FC2 <sub>H</sub>	—	(Disabled)	—	—
0FC3 <sub>H</sub>	AIDRL	A/D input disable register (Lower)	R/W	00000000 <sub>B</sub>
0FC4 <sub>H</sub> to 0FE3 <sub>H</sub>	—	(Disabled)	—	—
0FE4 <sub>H</sub>	CRTH	Main CR clock trimming register (Upper)	R/W	1XXXXXXX <sub>B</sub>
0FE5 <sub>H</sub>	CRTL	Main CR clock trimming register (Lower)	R/W	000XXXXX <sub>B</sub>
0FE6 <sub>H</sub> to 0FE7 <sub>H</sub>	—	(Disabled)	—	—
0FE8 <sub>H</sub>	SYSC	System configuration register	R/W	11000011 <sub>B</sub>

*(Continued)*

(Continued)

Address	Register abbreviation	Register name	R/W	Initial value
0FE9 <sub>H</sub>	CMCR	Clock monitoring control register	R/W	XX000000 <sub>B</sub>
0FEA <sub>H</sub>	CMDR	Clock monitoring data register	R/W	00000000 <sub>B</sub>
0FEB <sub>H</sub>	WDTH	Watchdog timer selection ID register (Upper)	R/W	XXXXXXXX <sub>B</sub>
0FEC <sub>H</sub>	WDTL	Watchdog timer selection ID register (Lower)	R/W	XXXXXXXX <sub>B</sub>
0FED <sub>H</sub>	—	(Disabled)	—	—
0FEE <sub>H</sub>	ILSR	Input level select register	R/W	00000000 <sub>B</sub>
0FEF <sub>H</sub> to 0FFF <sub>H</sub>	—	(Disabled)	—	—

**R/W access symbols**

- R/W : Readable / Writable
- R : Read only
- W : Write only

**Initial value symbols**

- 0 : The initial value of this bit is “0”.
- 1 : The initial value of this bit is “1”.
- X : The initial value of this bit is undefined.

Note: Do not write to an address that is “(Disabled)”. If a “(Disabled)” address is read, an undefined value is returned.

**16. Interrupt Source Table (MB95200H Series)**

Interrupt source	Interrupt request number	Vector table address		Bit name of interrupt level setting register	Priority order of interrupt sources of the same level (occurring simultaneously)
		Upper	Lower		
External interrupt ch. 4	IRQ0	FFFA <sub>H</sub>	FFFB <sub>H</sub>	L00 [1:0]	<div style="text-align: center;">High</div>  <div style="text-align: center;">Low</div>
External interrupt ch. 5	IRQ1	FFF8 <sub>H</sub>	FFF9 <sub>H</sub>	L01 [1:0]	
External interrupt ch. 2	IRQ2	FFF6 <sub>H</sub>	FFF7 <sub>H</sub>	L02 [1:0]	
External interrupt ch. 6					
External interrupt ch. 3	IRQ3	FFF4 <sub>H</sub>	FFF5 <sub>H</sub>	L03 [1:0]	
External interrupt ch. 7					
—	IRQ4	FFF2 <sub>H</sub>	FFF3 <sub>H</sub>	L04 [1:0]	
8/16-bit composite timer ch. 0 (Lower)	IRQ5	FFF0 <sub>H</sub>	FFF1 <sub>H</sub>	L05 [1:0]	
8/16-bit composite timer ch. 0 (Upper)	IRQ6	FFEE <sub>H</sub>	FFEF <sub>H</sub>	L06 [1:0]	
LIN-UART (reception)	IRQ7	FFEC <sub>H</sub>	FFED <sub>H</sub>	L07 [1:0]	
LIN-UART (transmission)	IRQ8	FFEA <sub>H</sub>	FFEB <sub>H</sub>	L08 [1:0]	
—	IRQ9	FFE8 <sub>H</sub>	FFE9 <sub>H</sub>	L09 [1:0]	
—	IRQ10	FFE6 <sub>H</sub>	FFE7 <sub>H</sub>	L10 [1:0]	
—	IRQ11	FFE4 <sub>H</sub>	FFE5 <sub>H</sub>	L11 [1:0]	
—	IRQ12	FFE2 <sub>H</sub>	FFE3 <sub>H</sub>	L12 [1:0]	
—	IRQ13	FFE0 <sub>H</sub>	FFE1 <sub>H</sub>	L13 [1:0]	
8/16-bit composite timer ch. 1 (Upper)	IRQ14	FFDE <sub>H</sub>	FFDF <sub>H</sub>	L14 [1:0]	
—	IRQ15	FFDC <sub>H</sub>	FFDD <sub>H</sub>	L15 [1:0]	
—	IRQ16	FFDA <sub>H</sub>	FFDB <sub>H</sub>	L16 [1:0]	
—	IRQ17	FFD8 <sub>H</sub>	FFD9 <sub>H</sub>	L17 [1:0]	
8/10-bit A/D converter	IRQ18	FFD6 <sub>H</sub>	FFD7 <sub>H</sub>	L18 [1:0]	
Timebase timer	IRQ19	FFD4 <sub>H</sub>	FFD5 <sub>H</sub>	L19 [1:0]	
Watch prescaler	IRQ20	FFD2 <sub>H</sub>	FFD3 <sub>H</sub>	L20 [1:0]	
—	IRQ21	FFD0 <sub>H</sub>	FFD1 <sub>H</sub>	L21 [1:0]	
8/16-bit composite timer ch. 1 (Lower)	IRQ22	FFCE <sub>H</sub>	FFCF <sub>H</sub>	L22 [1:0]	
Flash memory	IRQ23	FFCC <sub>H</sub>	FFCD <sub>H</sub>	L23 [1:0]	

**17. Interrupt Source Table (MB95210H Series)**

Interrupt source	Interrupt request number	Vector table address		Bit name of interrupt level setting register	Priority order of interrupt sources of the same level (occurring simultaneously)
		Upper	Lower		
External interrupt ch. 4	IRQ0	FFFA <sub>H</sub>	FFFB <sub>H</sub>	L00 [1:0]	<div style="text-align: center;">High</div>  <div style="text-align: center;">Low</div>
—	IRQ1	FFF8 <sub>H</sub>	FFF9 <sub>H</sub>	L01 [1:0]	
—	IRQ2	FFF6 <sub>H</sub>	FFF7 <sub>H</sub>	L02 [1:0]	
External interrupt ch. 6					
—	IRQ3	FFF4 <sub>H</sub>	FFF5 <sub>H</sub>	L03 [1:0]	
—					
—	IRQ4	FFF2 <sub>H</sub>	FFF3 <sub>H</sub>	L04 [1:0]	
8/16-bit composite timer ch. 0 (Lower)	IRQ5	FFF0 <sub>H</sub>	FFF1 <sub>H</sub>	L05 [1:0]	
8/16-bit composite timer ch. 0 (Upper)	IRQ6	FFEE <sub>H</sub>	FFEF <sub>H</sub>	L06 [1:0]	
—	IRQ7	FFEC <sub>H</sub>	FFED <sub>H</sub>	L07 [1:0]	
—	IRQ8	FFEA <sub>H</sub>	FFEB <sub>H</sub>	L08 [1:0]	
—	IRQ9	FFE8 <sub>H</sub>	FFE9 <sub>H</sub>	L09 [1:0]	
—	IRQ10	FFE6 <sub>H</sub>	FFE7 <sub>H</sub>	L10 [1:0]	
—	IRQ11	FFE4 <sub>H</sub>	FFE5 <sub>H</sub>	L11 [1:0]	
—	IRQ12	FFE2 <sub>H</sub>	FFE3 <sub>H</sub>	L12 [1:0]	
—	IRQ13	FFE0 <sub>H</sub>	FFE1 <sub>H</sub>	L13 [1:0]	
—	IRQ14	FFDE <sub>H</sub>	FFDF <sub>H</sub>	L14 [1:0]	
—	IRQ15	FFDC <sub>H</sub>	FFDD <sub>H</sub>	L15 [1:0]	
—	IRQ16	FFDA <sub>H</sub>	FFDB <sub>H</sub>	L16 [1:0]	
—	IRQ17	FFD8 <sub>H</sub>	FFD9 <sub>H</sub>	L17 [1:0]	
8/10-bit A/D converter	IRQ18	FFD6 <sub>H</sub>	FFD7 <sub>H</sub>	L18 [1:0]	
Timebase timer	IRQ19	FFD4 <sub>H</sub>	FFD5 <sub>H</sub>	L19 [1:0]	
Watch prescaler	IRQ20	FFD2 <sub>H</sub>	FFD3 <sub>H</sub>	L20 [1:0]	
—	IRQ21	FFD0 <sub>H</sub>	FFD1 <sub>H</sub>	L21 [1:0]	
—	IRQ22	FFCE <sub>H</sub>	FFCF <sub>H</sub>	L22 [1:0]	
Flash memory	IRQ23	FFCC <sub>H</sub>	FFCD <sub>H</sub>	L23 [1:0]	

## 18. Electrical Characteristics

### 18.1 Absolute Maximum Ratings

Parameter	Symbol	Rating		Unit	Remarks
		Min	Max		
Power supply voltage*1	$V_{CC}$	$V_{SS}-0.3$	$V_{SS}+6$	V	
Input voltage*1	$V_{I1}$	$V_{SS}-0.3$	$V_{CC}+0.3$	V	Other than PF2*2
	$V_{I2}$	$V_{SS}-0.3$	10.5	V	PF2
Output voltage*1	$V_O$	$V_{SS}-0.3$	$V_{SS}+6$	V	*2
Maximum clamp current	$I_{CLAMP}$	-2	+2	mA	Applicable to pins listed in *3
Total maximum clamp current	$\sum  I_{CLAMP} $	—	20	mA	Applicable to pins listed in *3
“L” level maximum output current	$I_{OL1}$	—	15	mA	Other than P05, P06, P62 and P63*4
	$I_{OL2}$	—	15		P05, P06, P62 and P63*4
“L” level average current	$I_{OLAV1}$	—	4	mA	Other than P05, P06, P62 and P63*4 Average output current = operating current × operating ratio (1 pin)
	$I_{OLAV2}$	—	12		P05, P06, P62 and P63*4 Average output current = operating current × operating ratio (1 pin)
“L” level total maximum output current	$\sum I_{OL}$	—	100	mA	
“L” level total average output current	$\sum I_{OLAV}$	—	50	mA	Total average output current = operating current × operating ratio (Total number of pins)
“H” level maximum output current	$I_{OH1}$	—	-15	mA	Other than P05, P06, P62 and P63*4
	$I_{OH2}$	—	-15		P05, P06, P62 and P63*4
“H” level average current	$I_{OHAV1}$	—	-4	mA	Other than P05, P06, P62 and P63*4 Average output current = operating current × operating ratio (1 pin)
	$I_{OHAV2}$	—	-8		P05, P06, P62 and P63*4 Average output current = operating current × operating ratio (1 pin)
“H” level total maximum output current	$\sum I_{OH}$	—	-100	mA	
“H” level total average output current	$\sum I_{OHAV}$	—	-50	mA	Total average output current = operating current × operating ratio (Total number of pins)
Power consumption	$P_d$	—	320	mW	
Operating temperature	$T_A$	-40	+85	°C	
Storage temperature	$T_{stg}$	-55	+150	°C	

- \*1: The parameter is based on  $V_{SS} = 0.0\text{ V}$ .
- \*2:  $V_I$  and  $V_O$  must not exceed  $V_{CC} + 0.3\text{ V}$ .  $V_I$  must not exceed the rated voltage. However, if the maximum current to/from an input is limited by means of an external component, the  $I_{CLAMP}$  rating is used instead of the  $V_I$  rating.
- \*3: Applicable to the following pins: P00 to P07, P62 to P64, PG1, PG2, PF0, PF1 (P00 to P03, P07, P62 to P64, PG1, PG2, PF0 and PF1 are available in MB95F204H/F203H/F202H/F204K/F203K/F202K.)
  - Use under recommended operating conditions.
  - Use with DC voltage (current).
  - The HV (High Voltage) signal is an input signal exceeding the  $V_{CC}$  voltage. Always connect a limiting resistor between the HV (High Voltage) signal and the microcontroller before applying the HV (High Voltage) signal.
  - The value of the limiting resistor should be set to a value at which the current to be input to the microcontroller pin when the HV (High Voltage) signal is input is below the standard value, irrespective of whether the current is transient current or stationary current.
  - When the microcontroller drive current is low, such as in low power consumption modes, the HV (High Voltage) input potential may pass through the protective diode to increase the potential of the  $V_{CC}$  pin, affecting other devices.
  - If the HV (High Voltage) signal is input when the microcontroller power supply is off (not fixed at 0 V), since power is supplied from the pins, incomplete operations may be executed.
  - If the HV (High Voltage) input is input after power-on, since power is supplied from the pins, the voltage of power supply may not be sufficient to enable a power-on reset.
  - Do not leave the HV (High Voltage) input pin unconnected.
  - Example of a recommended circuit:

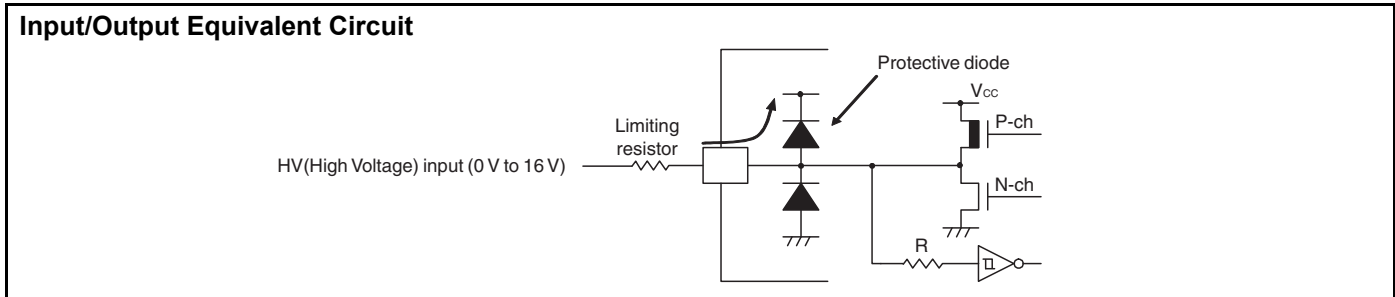

- \*4: P62 and P63 are available in MB95F204H/F203H/F202H/F204K/F203K/F202K.

**WARNING:** A semiconductor device may be damaged by applying stress (voltage, current, temperature, etc.) in excess of the absolute maximum rating. Therefore, ensure that not a single parameter exceeds its absolute maximum rating.

**18.2 Recommended Operating Conditions**

 (V<sub>SS</sub> = 0.0 V)

Parameter	Symbol	Value		Unit	Remarks	
		Min	Max			
Power supply voltage	V <sub>CC</sub>	2.4*1*2	5.5*1	V	In normal operation	Other than on-chip debug mode
		2.3	5.5		Hold condition in stop mode	
		2.9	5.5		In normal operation	On-chip debug mode
		2.3	5.5		Hold condition in stop mode	
Smoothing capacitor	C <sub>S</sub>	0.022	1	μF	*3	
Operating temperature	T <sub>A</sub>	-40	+85	°C	Other than on-chip debug function	
		+5	+35		On-chip debug function	

\*1: The value varies depending on the operating frequency, the machine clock and the analog guaranteed range.

\*2: The value is 2.88 V when the low-voltage detection reset is used.

\*3: Use a ceramic capacitor or a capacitor with equivalent frequency characteristics. The bypass capacitor for the V<sub>CC</sub> pin must have a capacitance larger than C<sub>S</sub>. For the connection to a smoothing capacitor C<sub>S</sub>, see the diagram below. To prevent the device from unintentionally entering an unknown mode due to noise, minimize the distance between the C pin and C<sub>S</sub> and the distance between C<sub>S</sub> and the V<sub>SS</sub> pin when designing the layout of a printed circuit board.

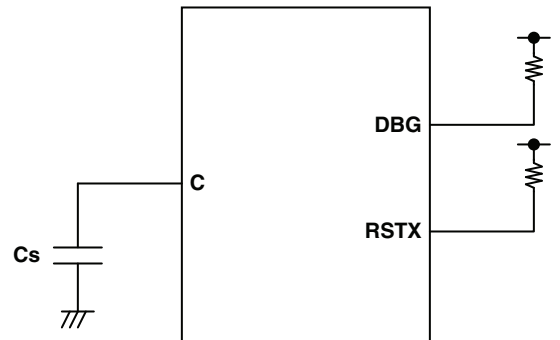
 ● **DBG / RSTX / C pin connection diagram**

\*: Since the DBG pin becomes a communication pin in on-chip debug mode, set a pull-up resistor value suiting the input/output specifications of P12/DBG.

**WARNING:** The recommended operating conditions are required in order to ensure the normal operation of the semiconductor device. All of the electrical characteristics of the device are warranted when the device is operated within these ranges. Always use semiconductor devices within their recommended operating condition ranges. Operation outside these ranges may adversely affect reliability and could result in device failure. No warranty is made with respect to uses, operating conditions, or combinations not represented on the data sheet. Users considering application outside the listed conditions are advised to contact sales representatives beforehand.

**18.3 DC Characteristics**
 $(V_{CC} = 5.0 V \pm 10\%, V_{SS} = 0.0 V, T_A = -40^\circ C \text{ to } +85^\circ C)$ 

Parameter	Symbol	Pin name	Condition	Value			Unit	Remarks
				Min	Typ	Max		
"H" level input voltage	$V_{IH1}$	P04	*1	$0.7 V_{CC}$	—	$V_{CC}+0.3$	V	When CMOS input level (hysteresis input) is selected
	$V_{IHS}$	P00 to P07, P12, P62 to P64, PF0 to PF1, PG1 to PG2	*1	$0.8 V_{CC}$	—	$V_{CC}+0.3$	V	Hysteresis input
	$V_{IHM}$	PF2	—	$0.7 V_{CC}$	—	10.5	V	Hysteresis input*5
"L" level input voltage	$V_{IL}$	P04	*1	$V_{SS}-0.3$	—	$0.3 V_{CC}$	V	When CMOS input level (hysteresis input) is selected
	$V_{ILS}$	P00 to P07, P12, P62 to P64, PF0 to PF1, PG1 to PG2	*1	$V_{SS}-0.3$	—	$0.2 V_{CC}$	V	Hysteresis input
	$V_{ILM}$	PF2	—	$V_{SS}-0.3$	—	$0.3 V_{CC}$	V	Hysteresis input
Open-drain output application voltage	$V_D$	PF2, P12	—	$V_{SS}-0.3$	—	$V_{SS}+5.5$	V	
"H" level output voltage	$V_{OH1}$	Output pins other than P05, P06, P62, P63, PF2 and P12*2	$I_{OH} = -4 \text{ mA}$	$V_{CC}-0.5$	—	—	V	
	$V_{OH2}$	P05, P06, P62, P63*2	$I_{OH} = -8 \text{ mA}$	$V_{CC}-0.5$	—	—	V	
"L" level output voltage	$V_{OL1}$	Output pins other than P05, P06, P62 and P63*2	$I_{OL} = 4 \text{ mA}$	—	—	0.4	V	
	$V_{OL2}$	P05, P06, P62, P63*2	$I_{OL} = 2 \text{ mA}$	—	—	0.4	V	
Input leak current (Hi-Z output leak current)	$I_{LI}$	All input pins	$0.0 V < V_I < V_{CC}$	-5	—	+5	$\mu A$	When pull-up resistance is disabled
Pull-up resistance	$R_{PULL}$	P00 to P07, PG1, PG2*3	$V_I = 0 V$	25	50	100	$k\Omega$	When pull-up resistance is enabled

*(Continued)*

$(V_{CC} = 5.0\text{ V} \pm 10\%, V_{SS} = 0.0\text{ V}, T_A = -40^\circ\text{C to } +85^\circ\text{C})$ 

Parameter	Symbol	Pin name	Condition	Value			Unit	Remarks
				Min	Typ	Max		
Input capacitance	$C_{IN}$	Other than $V_{CC}$ and $V_{SS}$	$f = 1\text{ MHz}$	—	5	15	pF	
Power supply current**4	$I_{CC}$	$V_{CC}$ (External clock operation)	$V_{CC} = 5.5\text{ V}$ $F_{CH} = 32\text{ MHz}$ $F_{MP} = 16\text{ MHz}$ Main clock mode (divided by 2)	—	13	17	mA	Flash memory product (except writing and erasing)
				—	33.5	39.5	mA	Flash memory product (at writing and erasing)
				—	15	21	mA	At A/D conversion
	$I_{CCS}$		$V_{CC} = 5.5\text{ V}$ $F_{CH} = 32\text{ MHz}$ $F_{MP} = 16\text{ MHz}$ Main sleep mode (divided by 2)	—	5.5	9	mA	
	$I_{CCL}$		$V_{CC} = 5.5\text{ V}$ $F_{CL} = 32\text{ kHz}$ $F_{MPL} = 16\text{ kHz}$ Subclock mode (divided by 2) $T_A = +25^\circ\text{C}$	—	65	153	$\mu\text{A}$	
	$I_{CCLS}$		$V_{CC} = 5.5\text{ V}$ $F_{CL} = 32\text{ kHz}$ $F_{MPL} = 16\text{ kHz}$ Subsleep mode (divided by 2) $T_A = +25^\circ\text{C}$	—	10	84	$\mu\text{A}$	
$I_{CCT}$	$V_{CC} = 5.5\text{ V}$ $F_{CL} = 32\text{ kHz}$ Watch mode Main stop mode $T_A = +25^\circ\text{C}$	—	5	30	$\mu\text{A}$			

*(Continued)*

$(V_{CC} = 5.0 V \pm 10\%, V_{SS} = 0.0 V, T_A = -40^\circ C \text{ to } +85^\circ C)$ 

Parameter	Symbol	Pin name	Condition	Value			Unit	Remarks
				Min	Typ	Max		
Power supply current*4	$I_{CCMCR}$	$V_{CC}$	$V_{CC} = 5.5 V$ $F_{CRH} = 10 \text{ MHz}$ $F_{MP} = 10 \text{ MHz}$ Main CR clock mode	—	8.6	—	mA	
	$I_{CCSCR}$		$V_{CC} = 5.5 V$ Sub-CR clock mode (divided by 2) $T_A = +25^\circ C$	—	110	410	$\mu A$	
	$I_{CCTS}$	$V_{CC}$ (External clock operation)	$V_{CC} = 5.5 V$ $F_{CH} = 32 \text{ MHz}$ Timebase timer mode $T_A = +25^\circ C$	—	1.1	3	mA	
	$I_{CCH}$		$V_{CC} = 5.5 V$ Substop mode $T_A = +25^\circ C$	—	3.5	22.5	$\mu A$	Main stop mode for single clock selection
	$I_{LVD}$	$V_{CC}$	Current consumption for low-voltage detection circuit only	—	37	54	$\mu A$	
	$I_{CRH}$		Current consumption for the internal main CR oscillator	—	0.5	0.6	mA	
	$I_{CRL}$		Current consumption for the internal sub-CR oscillator oscillating at 100 kHz	—	20	72	$\mu A$	

\*1: The input level of P04 can be switched between “CMOS input level” and “hysteresis input level”. The input level selection register (ILSR) is used to switch between the two input levels.

\*2: P62 and P63 are available in MB95F204H/F203H/F202H/F204K/F203K/F202K.

\*3: P00 to P03, P07, PG1 and PG2 are available in MB95F204H/F203H/F202H/F204K/F203K/F202K.

\*4: The power supply current is determined by the external clock. When the low-voltage detection option is selected, the power-supply current will be the sum of adding the current consumption of the low-voltage detection circuit ( $I_{LVD}$ ) to a specified value. In addition, when both the low-voltage detection option and the CR oscillator are selected, the power supply current will be the sum of adding up the current consumption of the low-voltage detection circuit, the current consumption of the CR oscillators ( $I_{CRH}$ ,  $I_{CRL}$ ) and a specified value. In on-chip debug mode, the CR oscillator ( $I_{CRH}$ ) and the low-voltage detection circuit are always enabled, and current consumption therefore increases accordingly.

- See “18.4. AC Characteristics: 18.4.1. Clock Timing” for  $F_{CH}$  and  $F_{CL}$ .

- See “18.4. AC Characteristics: 18.4.2. Source Clock/Machine Clock” for  $F_{MP}$  and  $F_{MPL}$ .

\*5 : PF2 act as high voltage supply for the flash memory during program and erase. It can tolerate high voltage input. For details, see section “18.6. Flash Memory Program/Erase Characteristics”.

**18.4 AC Characteristics**
**18.4.1 Clock Timing**
 $(V_{CC} = 2.4\text{ V to } 5.5\text{ V}, V_{SS} = 0.0\text{ V}, T_A = -40^\circ\text{C to } +85^\circ\text{C})$ 

Parameter	Symbol	Pin name	Condition	Value			Unit	Remarks	
				Min	Typ	Max			
Clock frequency	F <sub>CH</sub>	X0, X1	—	1	—	16.25	MHz	When the main oscillation circuit is used	
		X0	X1 open	1	—	12	MHz	When the main external clock is used	
		X0, X1	*	1	—	32.5	MHz		
		HCLK1, HCLK2	—						
	F <sub>CRH</sub>	—	—	—	9.7	10	10.3	MHz	When the main CR clock is used 3.3 V ≤ V <sub>CC</sub> ≤ 5.5 V (-40 °C ≤ T <sub>A</sub> ≤ 40 °C) 2.4 V ≤ V <sub>CC</sub> < 3.3 V (0 °C ≤ T <sub>A</sub> ≤ 40 °C)
					7.76	8	8.24	MHz	
					0.97	1	1.03	MHz	
					9.55	10	10.45	MHz	When the main CR clock is used 3.3 V ≤ V <sub>CC</sub> ≤ 5.5 V (40 °C < T <sub>A</sub> ≤ 85 °C)
					7.64	8	8.36	MHz	
					0.955	1	1.045	MHz	
					9.5	10	10.5	MHz	When the main CR clock is used 2.4 V ≤ V <sub>CC</sub> < 3.3 V (-40 °C ≤ T <sub>A</sub> < 0 °C, 40 °C < T <sub>A</sub> ≤ 85 °C)
					7.6	8	8.4	MHz	
	0.95	1	1.05	MHz					
	F <sub>CL</sub>	X0A, X1A	—	—	—	32.768	—	kHz	When the sub oscillation circuit is used
—					32.768	—	kHz	When the sub-external clock is used	
F <sub>CRL</sub>	—	—	—	50	100	200	kHz	When the sub-CR clock is used	
Clock cycle time	t <sub>H CYL</sub>	X0, X1	—	61.5	—	1000	ns	When the main oscillation circuit is used	
		X0	X1 open	83.4	—	1000	ns	When the external clock is used	
		X0, X1	*	30.8	—	1000	ns		
		HCLK1, HCLK2	—						
	t <sub>L CYL</sub>	X0A, X1A	—	—	30.5	—	μs	When the subclock is used	
Input clock pulse width	t <sub>WH1</sub> t <sub>WL1</sub>	X0	X1 open	33.4	—	—	ns	When the external clock is used, the duty ratio should range between 40% and 60%.	
		X0, X1	*	12.4	—	—	ns		
		HCLK1, HCLK2	—						
	t <sub>WH2</sub> t <sub>WL2</sub>	X0A	—	—	15.2	—	μs		

*(Continued)*

(Continued)

 ( $V_{CC} = 2.4\text{ V to }5.5\text{ V}$ ,  $V_{SS} = 0.0\text{ V}$ ,  $T_A = -40^\circ\text{C to }+85^\circ\text{C}$ )

Parameter	Symbol	Pin name	Condition	Value			Unit	Remarks
				Min	Typ	Max		
Input clock rise time and fall time	$t_{CR}$ $t_{CF}$	X0	X1 open	—	—	5	ns	When the external clock is used
		X0, X1	*	—	—	5	ns	
		HCLK1, HCLK2	—	—	—	—	—	
CR oscillation start time	$t_{CRHWK}$	—	—	—	—	80	$\mu\text{s}$	When the main CR clock is used
	$t_{CRLWK}$	—	—	—	—	10	$\mu\text{s}$	When the sub-CR clock is used

\* : The external clock signal is input to X0 and the inverted external clock signal to X1.

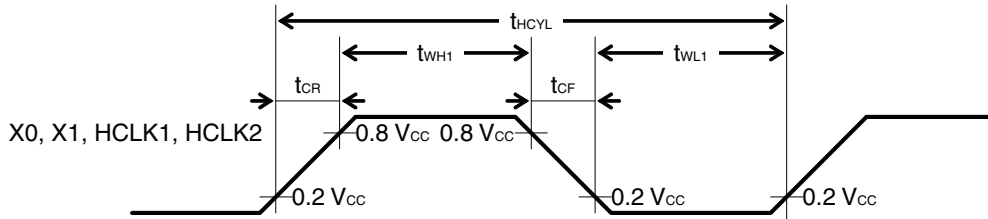

● Figure of main clock input port external connection

When a crystal oscillator or a ceramic oscillator is used

When the external clock is used (X1 is open)

When the external clock is used

When the external clock is used

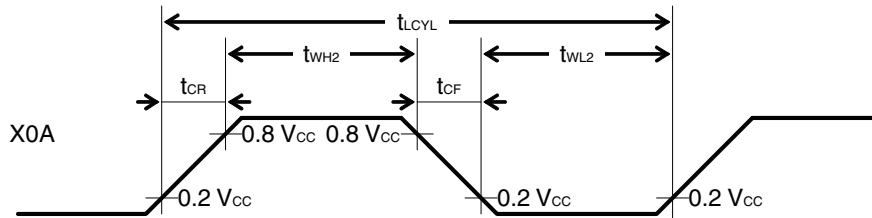
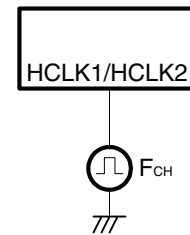
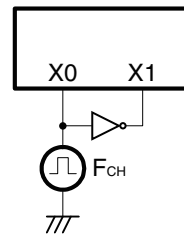
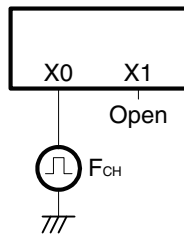
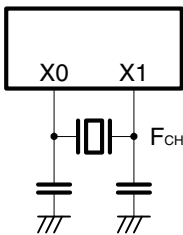

● Figure of subclock input port external connection

When a crystal oscillator or a ceramic oscillator is used

When the external clock is used

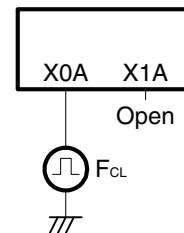
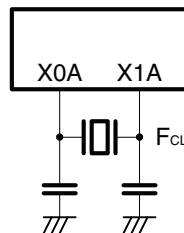

**18.4.2 Source Clock/Machine Clock**
 $(V_{CC} = 5.0 V \pm 10\%, V_{SS} = 0.0 V, T_A = -40^\circ C \text{ to } +85^\circ C)$ 

Parameter	Symbol	Pin name	Value			Unit	Remarks
			Min	Typ	Max		
Source clock cycle time*1	$t_{SCLK}$	—	61.5	—	2000	ns	When the main external clock is used Min: $F_{CH} = 32.5 \text{ MHz}$ , divided by 2 Max: $F_{CH} = 1 \text{ MHz}$ , divided by 2
			100	—	1000	ns	When the main CR clock is used Min: $F_{CRH} = 10 \text{ MHz}$ Max: $F_{CRH} = 1 \text{ MHz}$
			—	61	—	$\mu\text{s}$	When the sub-CR clock is used $F_{CL} = 32.768 \text{ kHz}$ , divided by 2
			—	20	—	$\mu\text{s}$	When the sub-oscillation clock is used $F_{CRL} = 100 \text{ kHz}$ , divided by 2
Source clock frequency	$F_{SP}$	—	0.5	—	16.25	MHz	When the main oscillation clock is used
			1	—	10	MHz	When the main CR clock is used
	$F_{SPL}$		—	16.384	—	kHz	When the sub-oscillation clock is used
			—	50	—	kHz	When the sub-CR clock is used $F_{CRL} = 100 \text{ kHz}$ , divided by 2
Machine clock cycle time*2(minimum instruction execution time)	$t_{MCLK}$	—	61.5	—	32000	ns	When the main oscillation clock is used Min: $F_{SP} = 16.25 \text{ MHz}$ , no division Max: $F_{SP} = 0.5 \text{ MHz}$ , divided by 16
			100	—	16000	ns	When the main CR clock is used Min: $F_{SP} = 10 \text{ MHz}$ Max: $F_{SP} = 1 \text{ MHz}$ , divided by 16
			61	—	976.5	$\mu\text{s}$	When the sub-oscillation clock is used Min: $F_{SPL} = 16.384 \text{ kHz}$ , no division Max: $F_{SPL} = 16.384 \text{ kHz}$ , divided by 16
			20	—	320	$\mu\text{s}$	When the sub-CR clock is used Min: $F_{SPL} = 50 \text{ kHz}$ , no division Max: $F_{SPL} = 50 \text{ kHz}$ , divided by 16
Machine clock frequency	$F_{MP}$	—	0.031	—	16.25	MHz	When the main oscillation clock is used
			0.0625	—	10	MHz	When the main CR clock is used
	$F_{MPL}$		1.024	—	16.384	kHz	When the sub-oscillation clock is used
			3.125	—	50	kHz	When the sub-CR clock is used $F_{CRL} = 100 \text{ kHz}$

\*1: This is the clock before it is divided according to the division ratio set by the machine clock division ratio selection bits (SYCC : DIV1 and DIV0) . This source clock is divided to become a machine clock according to the division ratio set by the machine clock division ratio selection bits (SYCC : DIV1 and DIV0) . In addition, a source clock can be selected from the following.

- Main clock divided by 2
- Main CR clock
- Subclock divided by 2
- Sub-CR clock divided by 2

\*2: This is the operating clock of the microcontroller. A machine clock can be selected from the following.

- Source clock (no division)
- Source clock divided by 4
- Source clock divided by 8
- Source clock divided by 16

- Schematic diagram of the clock generation block

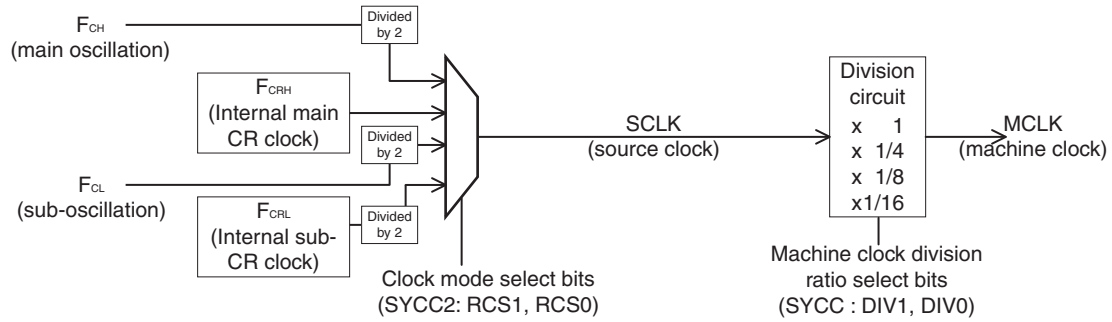

- Operating voltage - Operating frequency (When  $T_A = -40\text{ }^\circ\text{C}$  to  $+85\text{ }^\circ\text{C}$ )

➤ MB95200H/210H (without the on-chip debug function)

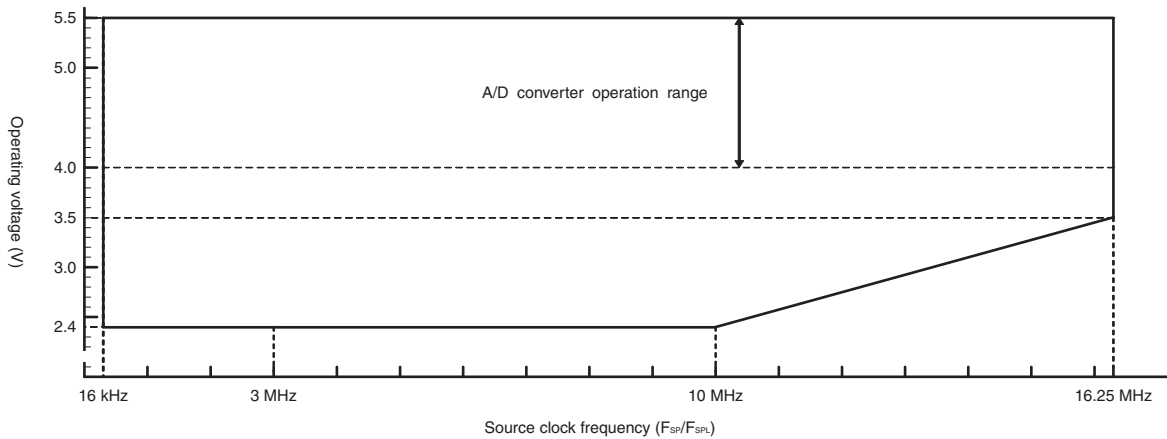

- Operating voltage - Operating frequency (When  $T_A = +5\text{ }^\circ\text{C}$  to  $+35\text{ }^\circ\text{C}$ )

➤ MB95200H/210H (with the on-chip debug function)

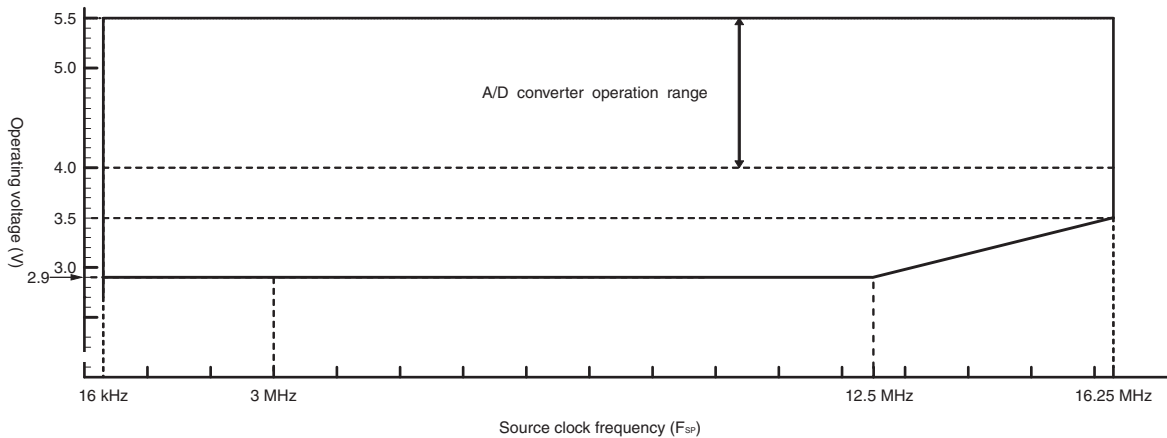

18.4.3 External Reset

( $V_{CC} = 5.0 V \pm 10\%$ ,  $V_{SS} = 0.0 V$ ,  $T_A = -40^\circ C$  to  $+85^\circ C$ )

Parameter	Symbol	Value		Unit	Remarks
		Min	Max		
RSTX "L" level pulse width	$t_{RSTL}$	$2 t_{MCLK}^{*1}$	—	ns	In normal operation
		Oscillation time of the oscillator <sup>*2</sup> +100	—	$\mu s$	In stop mode, subclock mode, sub-sleep mode, watch mode, and power on
		100	—	$\mu s$	In timebase timer mode

\*1: See "18.4.2. Source Clock/Machine Clock" for  $t_{MCLK}$ .

\*2: The oscillation time of an oscillator is the time that the amplitude reaches 90%. The crystal oscillator has an oscillation time of between several ms and tens of ms. The ceramic oscillator has an oscillation time of between hundreds of  $\mu s$  and several ms. The external clock has an oscillation time of 0 ms. The CR oscillator clock has an oscillation time of between several  $\mu s$  and several ms.

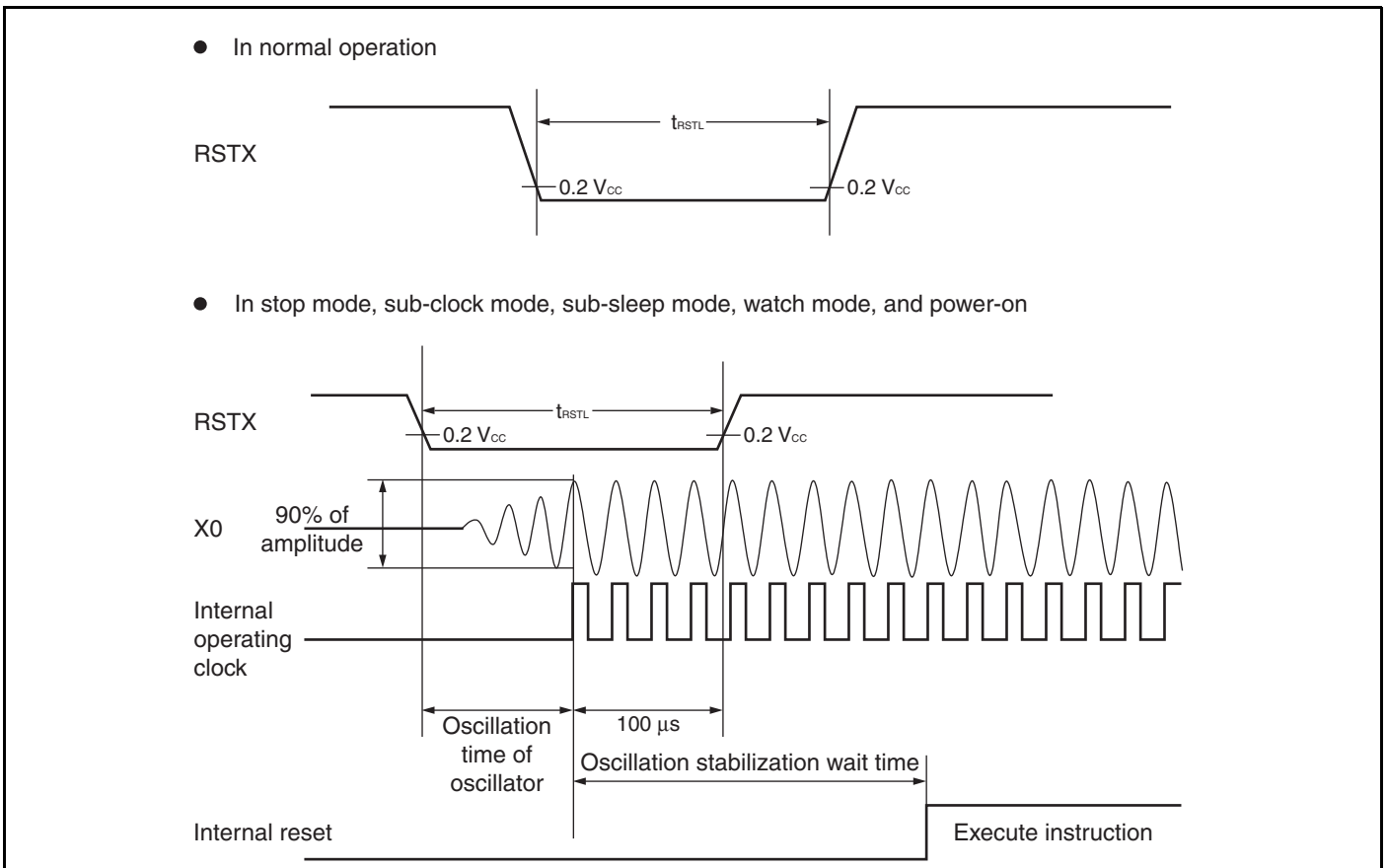

**18.4.4 Power-on Reset**
 $(V_{SS} = 0.0\text{ V}, T_A = -40^\circ\text{C to } +85^\circ\text{C})$ 

Parameter	Symbol	Condition	Value		Unit	Remarks
			Min	Max		
Power supply rising time	$t_R$	—	—	50	ms	
Power supply cutoff time	$t_{OFF}$	—	1	—	ms	Wait time until power-on

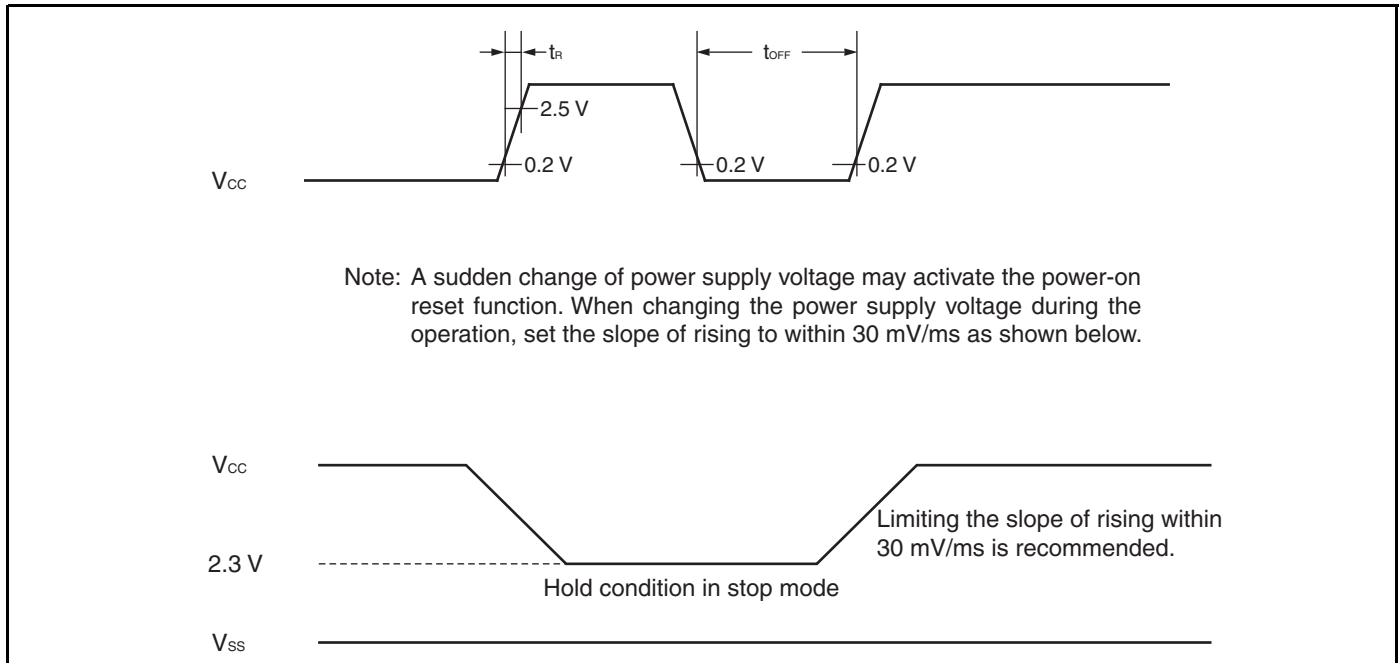
**18.4.5 Peripheral Input Timing**
 $(V_{CC} = 5.0\text{ V} \pm 10\%, V_{SS} = 0.0\text{ V}, T_A = -40^\circ\text{C to } +85^\circ\text{C})$ 

Parameter	Symbol	Pin name	Value		Unit
			Min	Max	
Peripheral input "H" pulse width	$t_{ILIH}$	INT02 to INT07, EC0, EC1 <sup>*2</sup>	$2 t_{MCLK}^{*1}$	—	ns
Peripheral input "L" pulse width	$t_{IHIL}$		$2 t_{MCLK}^{*1}$	—	ns

\*1: See "18.4.2. Source Clock/Machine Clock" for  $t_{MCLK}$ .

\*2: INT02, INT03, INT05, INT07 and EC1 are available in MB95F204H/F203H/F202H/F204K/F203K/F202K.

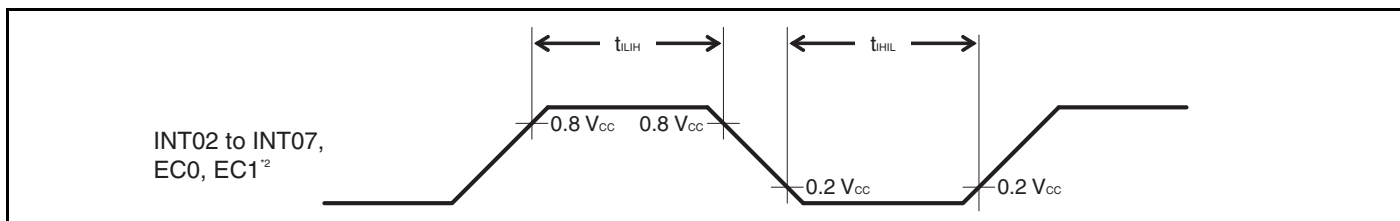

**18.4.6 LIN-UART Timing (Available in MB95F204H/F203H/F202H/F204K/F203K/F202K only)**

Sampling is executed at the rising edge of the sampling clock\*<sup>1</sup>, and serial clock delay is disabled\*<sup>2</sup>. (ESCR register : SCES bit = 0, ECCR register : SCDE bit = 0)

(V<sub>CC</sub> = 5.0 V±10%, AV<sub>SS</sub> = V<sub>SS</sub> = 0.0 V, T<sub>A</sub> = -40°C to +85°C)

Parameter	Symbol	Pin name	Condition	Value		Unit
				Min	Max	
Serial clock cycle time	t <sub>SCYC</sub>	SCK	Internal clock operation output pin: C <sub>L</sub> = 80 pF+1 TTL	5 t <sub>MCLK</sub> <sup>*3</sup>	—	ns
SCK ↓→ SOT delay time	t <sub>SLOVI</sub>	SCK, SOT		-95	+95	ns
Valid SIN → SCK ↑	t <sub>IVSHI</sub>	SCK, SIN		t <sub>MCLK</sub> <sup>*3</sup> +190	—	ns
SCK ↑→ valid SIN hold time	t <sub>SHIXI</sub>	SCK, SIN		0	—	ns
Serial clock "L" pulse width	t <sub>SLSH</sub>	SCK	External clock operation output pin: C <sub>L</sub> = 80 pF+1 TTL	3 t <sub>MCLK</sub> <sup>*3</sup> -t <sub>R</sub>	—	ns
Serial clock "H" pulse width	t <sub>SHSL</sub>	SCK		t <sub>MCLK</sub> <sup>*3</sup> +95	—	ns
SCK ↓→ SOT delay time	t <sub>SLOVE</sub>	SCK, SOT		—	2 t <sub>MCLK</sub> <sup>*3</sup> +95	ns
Valid SIN → SCK ↑	t <sub>IVSHE</sub>	SCK, SIN		190	—	ns
SCK ↑→ valid SIN hold time	t <sub>SHIXE</sub>	SCK, SIN		t <sub>MCLK</sub> <sup>*3</sup> +95	—	ns
SCK fall time	t <sub>F</sub>	SCK		—	10	ns
SCK rise time	t <sub>R</sub>	SCK		—	10	ns

\*1: There is a function used to choose whether the sampling of reception data is performed at a rising edge or a falling edge of the serial clock.

\*2: The serial clock delay function is a function used to delay the output signal of the serial clock for half the clock.

\*3: See "18.4.2. Source Clock/Machine Clock" for t<sub>MCLK</sub>.

● Internal shift clock mode

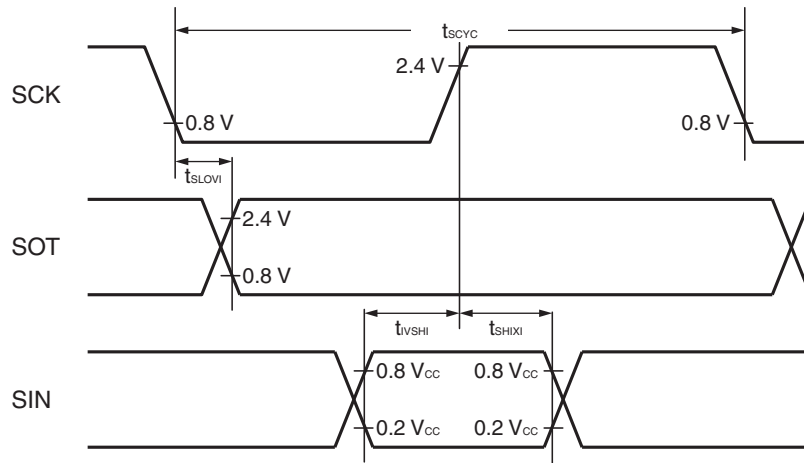

● External shift clock mode

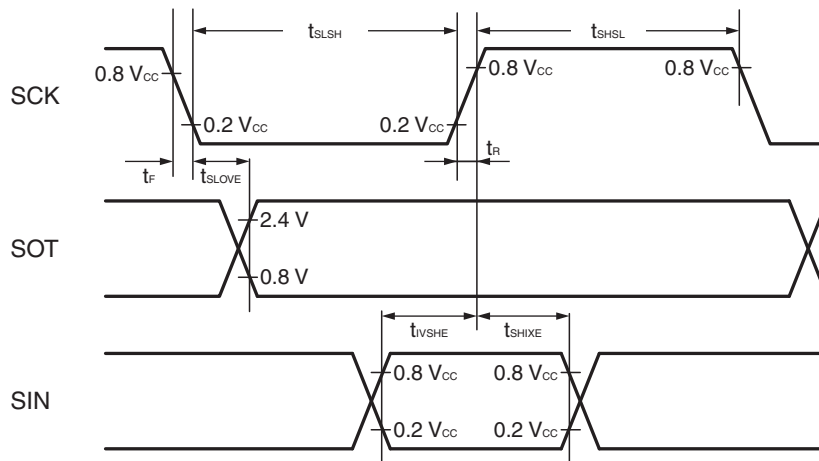

Sampling is executed at the falling edge of the sampling clock\*<sup>1</sup>, and serial clock delay is disabled\*<sup>2</sup>. (ESCR register : SCES bit = 1, ECCR register : SCDE bit = 0)

(V<sub>CC</sub> = 5.0 V±10%, V<sub>SS</sub> = 0.0 V, T<sub>A</sub> = -40°C to +85°C)

Parameter	Symbol	Pin name	Condition	Value		Unit
				Min	Max	
Serial clock cycle time	t <sub>SCYC</sub>	SCK	Internal clock operation output pin: C <sub>L</sub> = 80 pF+1 TTL	5 t <sub>MCLK</sub> <sup>*3</sup>	—	ns
SCK ↑→ SOT delay time	t <sub>SHOVI</sub>	SCK, SOT		-95	+95	ns
Valid SIN → SCK ↓	t <sub>IVSLI</sub>	SCK, SIN		t <sub>MCLK</sub> <sup>*3</sup> +190	—	ns
SCK ↓→ valid SIN hold time	t <sub>SLIXI</sub>	SCK, SIN		0	—	ns
Serial clock "H" pulse width	t <sub>SHSL</sub>	SCK	External clock operation output pin: C <sub>L</sub> = 80 pF+1 TTL	3 t <sub>MCLK</sub> <sup>*3</sup> -t <sub>R</sub>	—	ns
Serial clock "L" pulse width	t <sub>SLSH</sub>	SCK		t <sub>MCLK</sub> <sup>*3</sup> +95	—	ns
SCK ↑→ SOT delay time	t <sub>SHOVE</sub>	SCK, SOT		—	2 t <sub>MCLK</sub> <sup>*3</sup> +95	ns
Valid SIN → SCK ↓	t <sub>IVSLE</sub>	SCK, SIN		190	—	ns
SCK ↓→ valid SIN hold time	t <sub>SLIXE</sub>	SCK, SIN		t <sub>MCLK</sub> <sup>*3</sup> +95	—	ns
SCK fall time	t <sub>F</sub>	SCK		—	10	ns
SCK rise time	t <sub>R</sub>	SCK		—	10	ns

\*1: There is a function used to choose whether the sampling of reception data is performed at a rising edge or a falling edge of the serial clock.

\*2: The serial clock delay function is a function used to delay the output signal of the serial clock for half the clock.

\*3: See "18.4.2. Source Clock/Machine Clock" for t<sub>MCLK</sub>.

● Internal shift clock mode

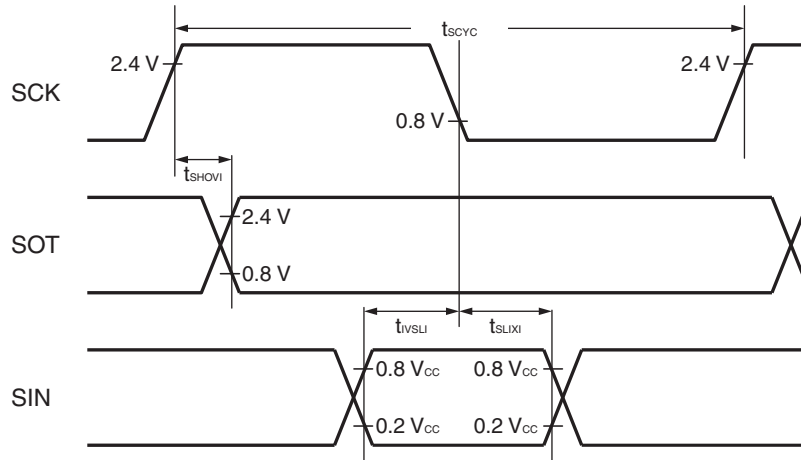

● External shift clock mode

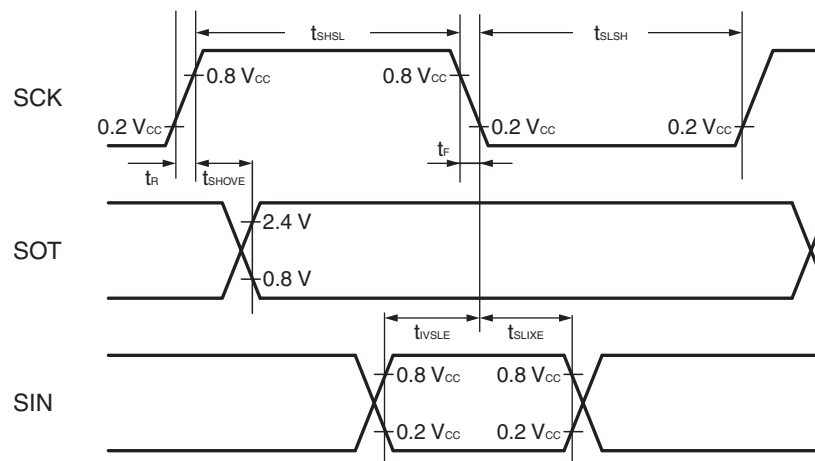

Sampling is executed at the rising edge of the sampling clock\*<sup>1</sup>, and serial clock delay is enabled\*<sup>2</sup>. (ESCR register : SCES bit = 0, ECCR register : SCDE bit = 1)

( $V_{CC} = 5.0 V \pm 10\%$ ,  $V_{SS} = 0.0 V$ ,  $T_A = -40^\circ C$  to  $+85^\circ C$ )

Parameter	Symbol	Pin name	Condition	Value		Unit
				Min	Max	
Serial clock cycle time	$t_{SCYC}$	SCK	Internal clock operation output pin: $C_L = 80 \text{ pF} + 1 \text{ TTL}$	$5 t_{MCLK}^{*3}$	—	ns
SCK $\uparrow \rightarrow$ SOT delay time	$t_{SHOVI}$	SCK, SOT		-95	+95	ns
Valid SIN $\rightarrow$ SCK $\downarrow$	$t_{IVSLI}$	SCK, SIN		$t_{MCLK}^{*3} + 190$	—	ns
SCK $\downarrow \rightarrow$ valid SIN hold time	$t_{SLIXI}$	SCK, SIN		0	—	ns
SOT $\rightarrow$ SCK $\downarrow$ delay time	$t_{SOVLI}$	SCK, SOT		—	$4 t_{MCLK}^{*3}$	ns

\*1: There is a function used to choose whether the sampling of reception data is performed at a rising edge or a falling edge of the serial clock.

\*2: The serial clock delay function is a function that delays the output signal of the serial clock for half clock.

\*3: See "18.4.2. Source Clock/Machine Clock" for  $t_{MCLK}$ .

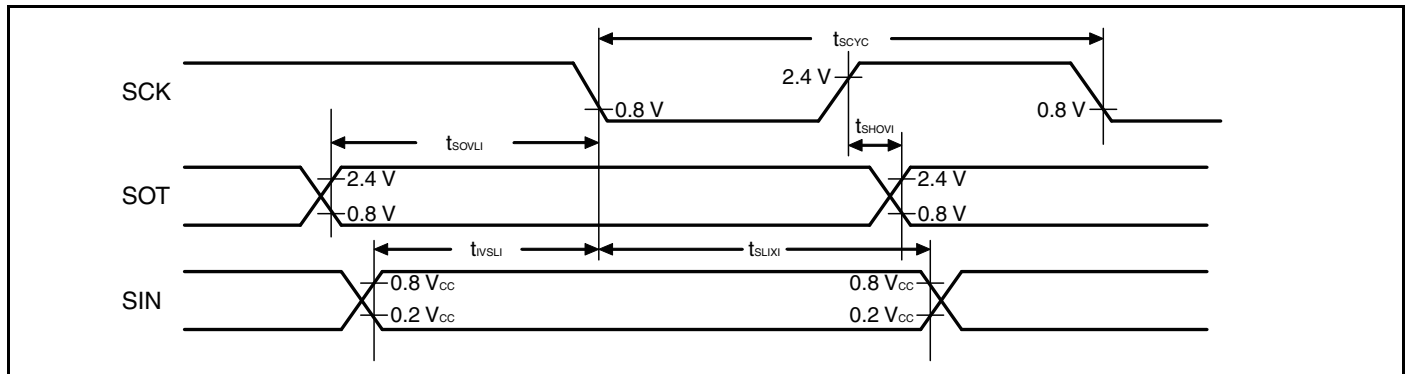

Sampling is executed at the falling edge of the sampling clock\*1, and serial clock delay is enabled\*2.  
 (ESCR register : SCES bit = 1, ECCR register : SCDE bit = 1)

( $V_{CC} = 5.0 V \pm 10\%$ ,  $V_{SS} = 0.0 V$ ,  $T_A = -40^\circ C$  to  $+85^\circ C$ )

Parameter	Symbol	Pin name	Condition	Value		Unit
				Min	Max	
Serial clock cycle time	$t_{SCYC}$	SCK	Internal clock operation output pin: $C_L = 80 \text{ pF} + 1 \text{ TTL}$	$5 t_{MCLK}^{*3}$	—	ns
SCK $\downarrow \rightarrow$ SOT delay time	$t_{SLOVI}$	SCK, SOT		-95	+95	ns
Valid SIN $\rightarrow$ SCK $\uparrow$	$t_{IVSHI}$	SCK, SIN		$t_{MCLK}^{*3} + 190$	—	ns
SCK $\uparrow \rightarrow$ valid SIN hold time	$t_{SHIXI}$	SCK, SIN		0	—	ns
SOT $\rightarrow$ SCK $\uparrow$ delay time	$t_{SOVHI}$	SCK, SOT		—	$4 t_{MCLK}^{*3}$	ns

\*1: There is a function used to choose whether the sampling of reception data is performed at a rising edge or a falling edge of the serial clock.

\*2: The serial clock delay function is a function that delays the output signal of the serial clock for half clock.

\*3: See "18.4.2.Source Clock/Machine Clock" for  $t_{MCLK}$ .

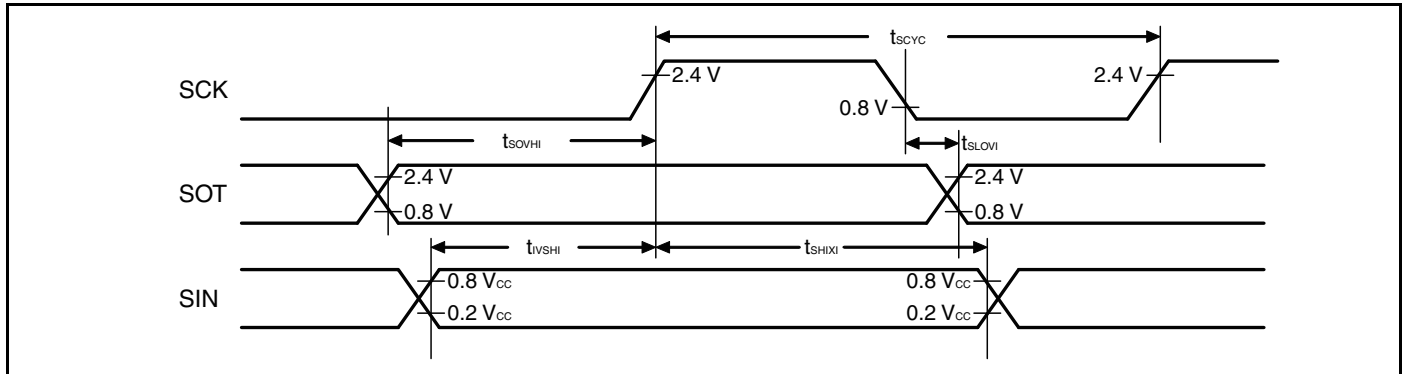

**18.4.7 Low-voltage Detection**

 ( $V_{SS} = 0.0\text{ V}$ ,  $T_A = -40^\circ\text{C}$  to  $+85^\circ\text{C}$ )

Parameter	Symbol	Value			Unit	Remarks
		Min	Typ	Max		
Release voltage	$V_{DL+}$	2.52	2.7	2.88	V	At power supply rise
Detection voltage	$V_{DL-}$	2.42	2.6	2.78	V	At power supply fall
Hysteresis width	$V_{HYS}$	70	100	—	mV	
Power supply start voltage	$V_{off}$	—	—	2.3	V	
Power supply end voltage	$V_{on}$	4.9	—	—	V	
Power supply voltage change time (at power supply rise)	$t_r$	1	—	—	$\mu\text{s}$	Slope of power supply that the reset release signal generates
		—	3000	—	$\mu\text{s}$	Slope of power supply that the reset release signal generates within the rating ( $V_{DL+}$ )
Power supply voltage change time (at power supply fall)	$t_f$	300	—	—	$\mu\text{s}$	Slope of power supply that the reset detection signal generates
		—	300	—	$\mu\text{s}$	Slope of power supply that the reset detection signal generates within the rating ( $V_{DL-}$ )
Reset release delay time	$t_{d1}$	—	—	300	$\mu\text{s}$	
Reset detection delay time	$t_{d2}$	—	—	20	$\mu\text{s}$	

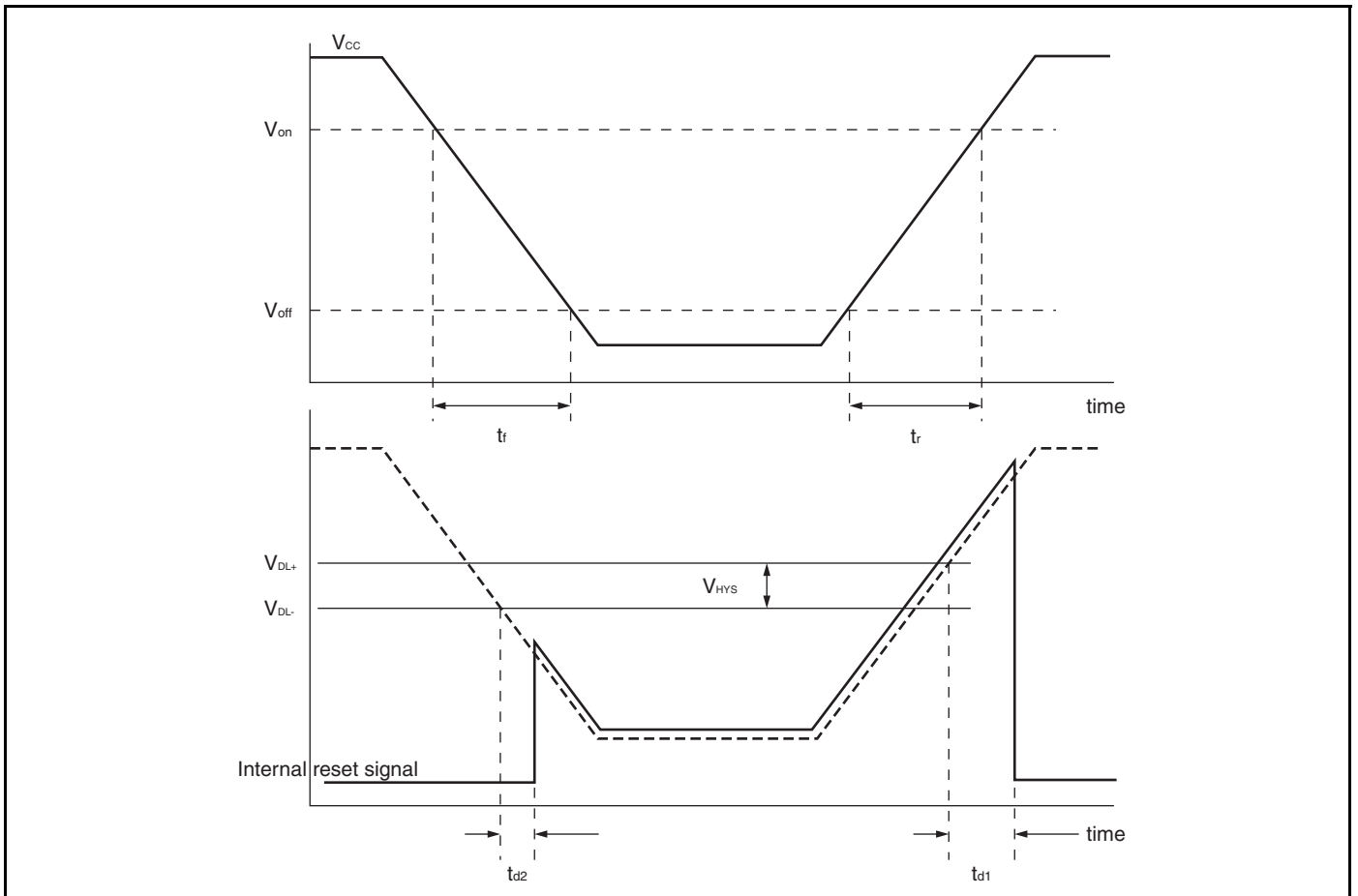

**18.5 A/D Converter**
**18.5.1 A/D Converter Electrical Characteristics**
 $(V_{CC} = 4.0\text{ V to } 5.5\text{ V}, V_{SS} = 0.0\text{ V}, T_A = -40^\circ\text{C to } +85^\circ\text{C})$ 

Parameter	Symbol	Value			Unit	Remarks
		Min	Typ	Max		
Resolution	—	—	—	10	bit	
Total error		-3	—	+3	LSB	
Linearity error		-2.5	—	+2.5	LSB	
Differential linear error		-1.9	—	+1.9	LSB	
Zero transition voltage	$V_{OT}$	$V_{SS}-1.5\text{ LSB}$	$V_{SS}+0.5\text{ LSB}$	$V_{SS}+2.5\text{ LSB}$	V	
Full-scale transition voltage	$V_{FST}$	$V_{CC}-4.5\text{ LSB}$	$V_{CC}-2\text{ LSB}$	$V_{CC}+0.5\text{ LSB}$	V	
Compare time	—	0.9	—	16500	$\mu\text{s}$	$4.5\text{ V} \leq V_{CC} \leq 5.5\text{ V}$
		1.8	—	16500	$\mu\text{s}$	$4.0\text{ V} \leq V_{CC} < 4.5\text{ V}$
Sampling time	—	0.6	—	¥	$\mu\text{s}$	$4.5\text{ V} \leq V_{CC} \leq 5.5\text{ V}$ , with external impedance $< 5.4\text{ k}\Omega$
		1.2	—	¥	$\mu\text{s}$	$4.0\text{ V} \leq V_{CC} \leq 4.5\text{ V}$ , with external impedance $< 2.4\text{ k}\Omega$
Analog input current	$I_{AIN}$	-0.3	—	+0.3	$\mu\text{A}$	
Analog input voltage	$V_{AIN}$	$V_{SS}$	—	$V_{CC}$	V	

18.5.2 Notes on Using the A/D Converter

**External impedance of analog input and its sampling time**

- The A/D converter has a sample and hold circuit. If the external impedance is too high to keep sufficient sampling time, the analog voltage charged to the internal sample and hold capacitor is insufficient, adversely affecting A/D conversion precision. Therefore, to satisfy the A/D conversion precision standard, considering the relationship between the external impedance and minimum sampling time, either adjust the register value and operating frequency or decrease the external impedance so that the sampling time is longer than the minimum value. In addition, if sufficient sampling time cannot be secured, connect a capacitor of about 0.1  $\mu\text{F}$  to the analog input pin.

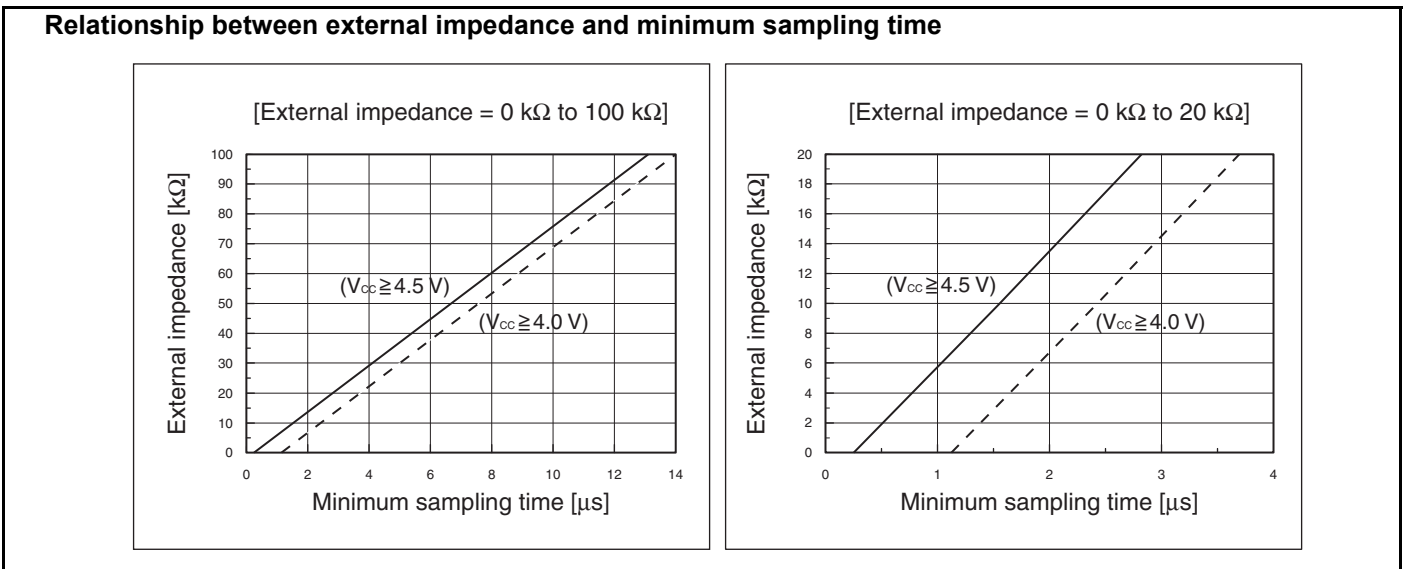
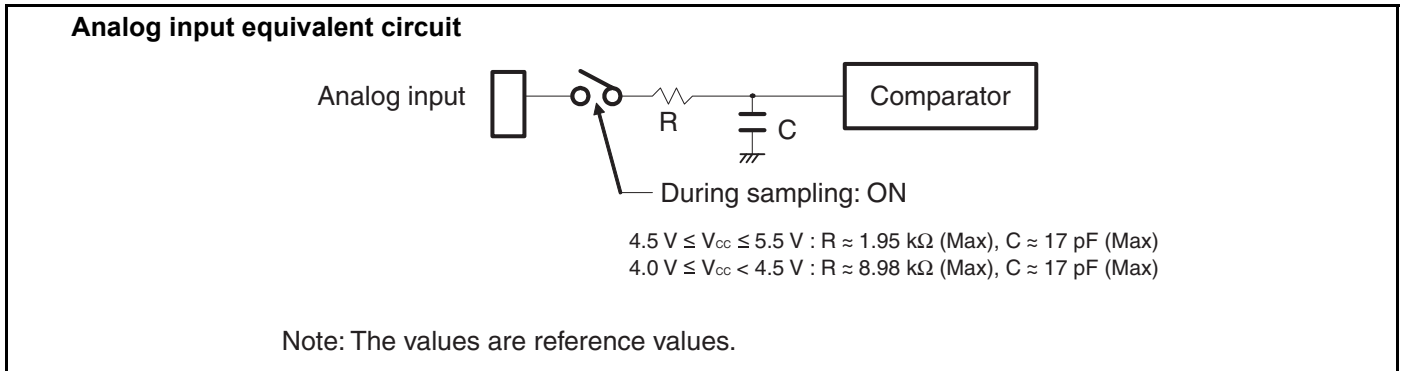

**A/D conversion error**

As  $|V_{\text{CC}} - V_{\text{SS}}|$  decreases, the A/D conversion error increases proportionately.

**18.5.3 Definitions of A/D Converter Terms**

■ **Resolution**

It indicates the level of analog variation that can be distinguished by the A/D converter. When the number of bits is 10, analog voltage can be divided into  $2^{10} = 1024$ .

■ **Linearity error (unit: LSB)**

It indicates how much an actual conversion value deviates from the straight line connecting the zero transition point (“00 0000 0000” ← → “00 0000 0001”) of a device to the full-scale transition point (“11 1111 1111” ← → “11 1111 1110”) of the same device.

■ **Differential linear error (unit: LSB)**

It indicates how much the input voltage required to change the output code by 1 LSB deviates from an ideal value.

■ **Total error (unit: LSB)**

It indicates the difference between an actual value and a theoretical value. The error can be caused by a zero transition error, a full-scale transition errors, a linearity error, a quantum error, or noise.

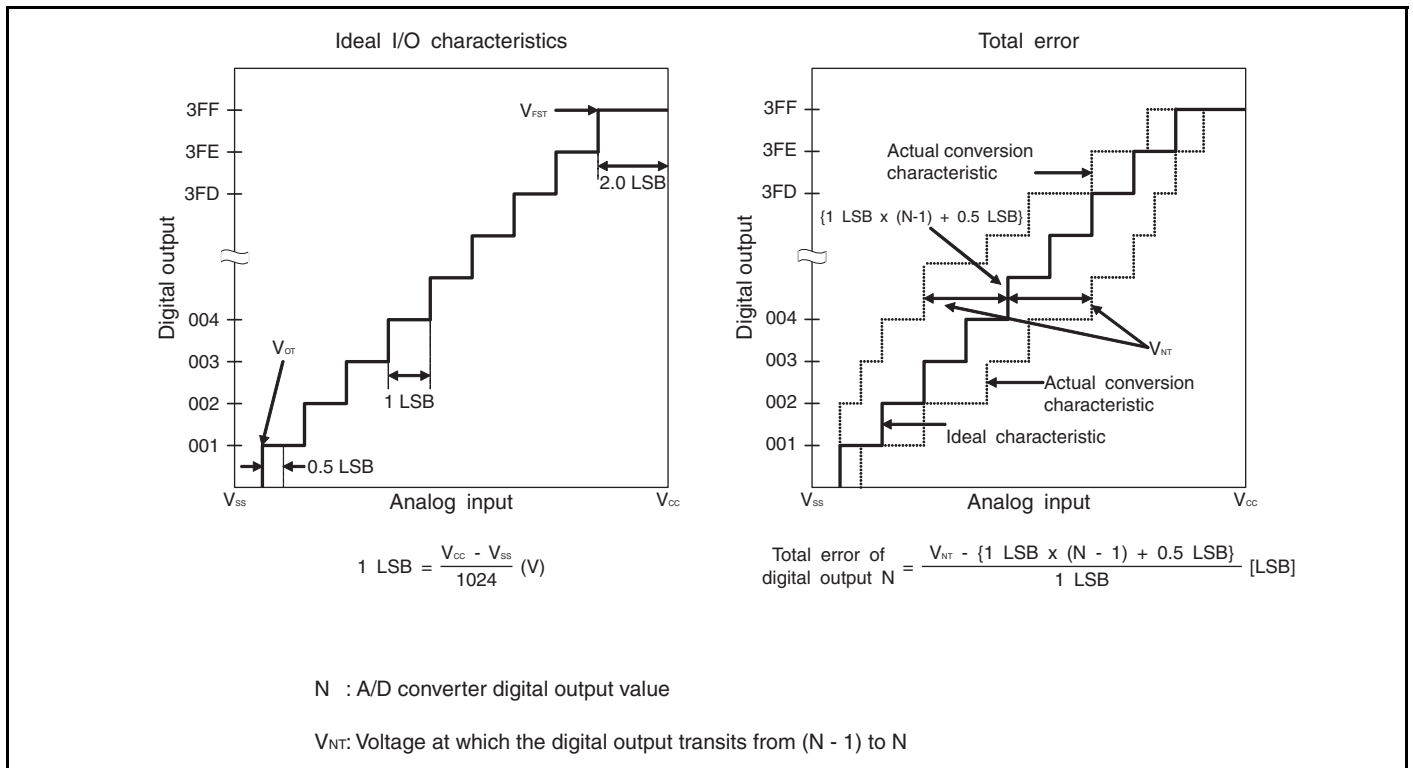

*(Continued)*

(Continued)

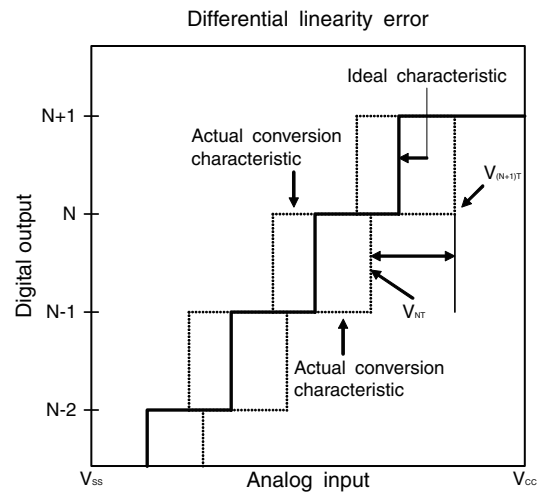
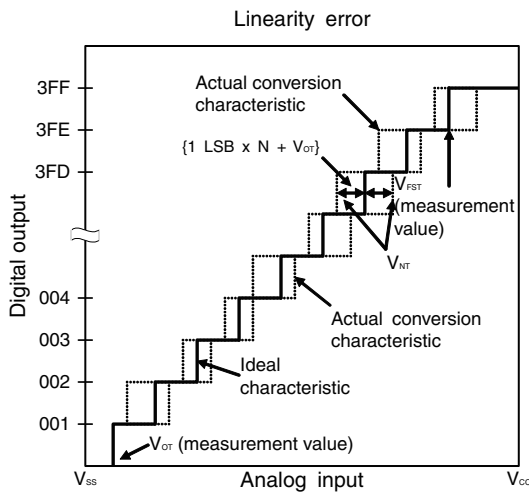
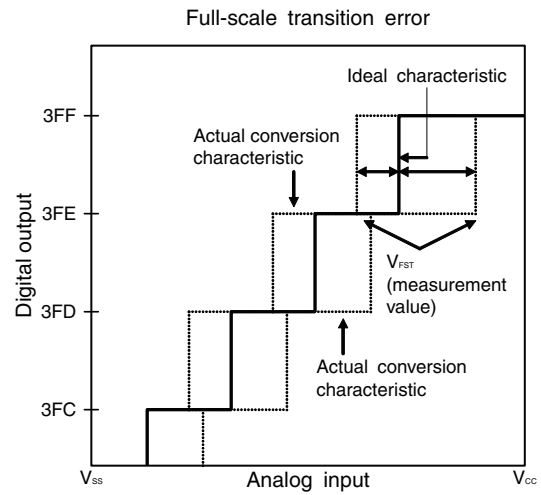
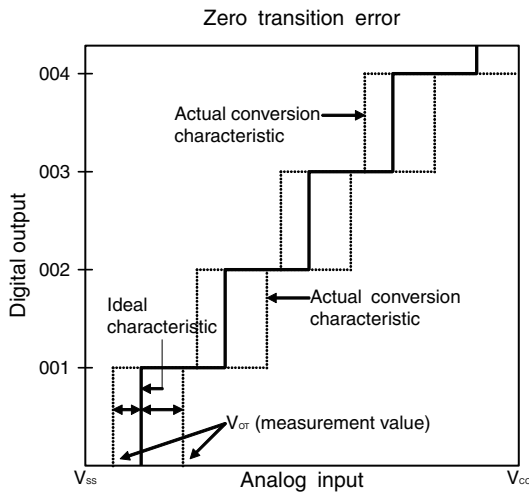

$$\text{Linearity error of digital output } N = \frac{V_{NT} - \{1 \text{ LSB} \times N + V_{OT}\}}{1 \text{ LSB}}$$

$$\text{Differential linear error of digital output } N = \frac{V_{(N+1)T} - V_{NT}}{1 \text{ LSB}} - 1$$

N : A/D converter digital output value

V<sub>NT</sub>: Voltage at which the digital output transits from (N - 1) to N

V<sub>OT</sub> (ideal value) = V<sub>SS</sub> + 0.5 LSB [V]

V<sub>FST</sub> (ideal value) = V<sub>CC</sub> - 2.0 LSB [V]

**18.6 Flash Memory Program/Erase Characteristics**

Parameter	Value			Unit	Remarks
	Min	Typ	Max		
Chip erase time	—	1*1	15*2	s	00 <sub>H</sub> programming time prior to erasure is excluded.
Byte programming time	—	32	3600	μs	System-level overhead is excluded.
Erase/program voltage	9.5	10	10.5	V	The erase/program voltage must be applied to the PF2 pin in erase/program.
Current drawn on PF2	—	—	5.0	mA	Current consumption of PF2 pin during flash memory program/erase
Erase/program cycle	—	100000	—	cycle	
Power supply voltage at erase/program	3.0	—	5.5	V	
Flash memory data retention time	20*3	—	—	year	Average T <sub>A</sub> = +85°C

\*1: T<sub>A</sub> = +25°C, V<sub>CC</sub> = 5.0 V, 100000 cycles

\*2: T<sub>A</sub> = +85°C, V<sub>CC</sub> = 4.5 V, 100000 cycles

\*3: This value is converted from the result of a technology reliability assessment. (The value is converted from the result of a high temperature accelerated test by using the Arrhenius equation with the average temperature being +85°C) .

**19. Sample Electrical Characteristics**

**Power supply current-temperature**

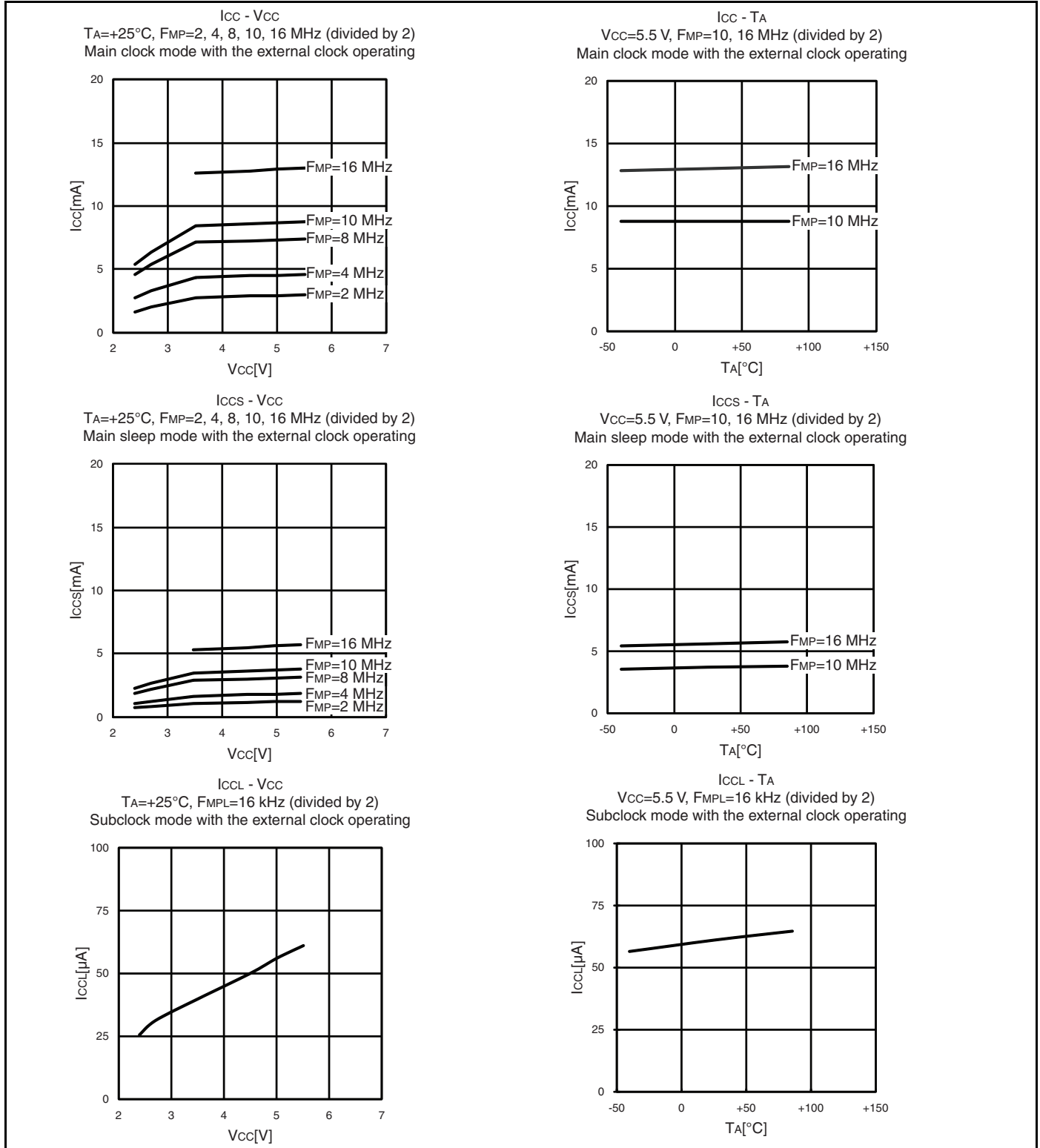

(Continued)

(Continued)

**ICCLS - VCC**  
 $T_A = +25^\circ\text{C}$ , FMPL=16 kHz (divided by 2)  
 Subsleep mode with the external clock operating

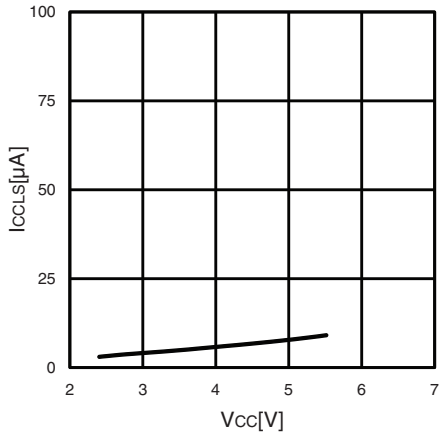

**ICCLS - TA**  
 $V_{CC} = 5.5\text{ V}$ , FMPL=16 kHz (divided by 2)  
 Subsleep mode with the external clock operating

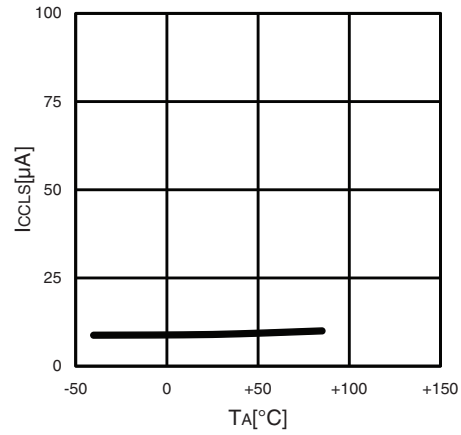

**ICCT - VCC**  
 $T_A = +25^\circ\text{C}$ , FMPL=16 kHz (divided by 2)  
 Clock mode with the external clock operating

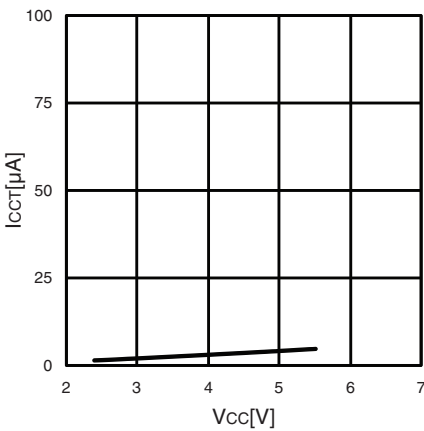

**ICCT - TA**  
 $V = 5.5\text{ V}$ , FMPL=16 kHz (divided by 2)  
 Clock mode with the external clock operating

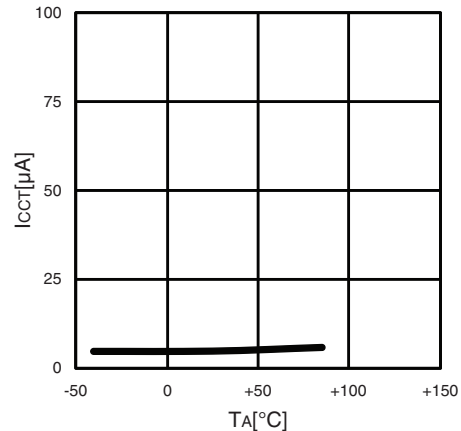

**ICTS - VCC**  
 $T_A = +25^\circ\text{C}$ , FMP=2, 4, 8, 10, 16 MHz (divided by 2)  
 Timebase timer mode with the external clock operating

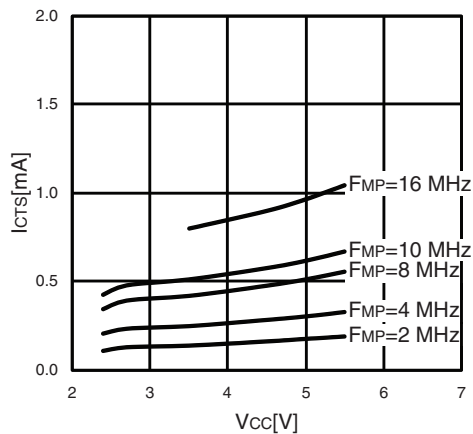

**ICTS - TA**  
 $V = 5.5\text{ V}$ , FMP=10, 16 MHz (divided by 2)  
 Timebase timer mode with the external clock operating

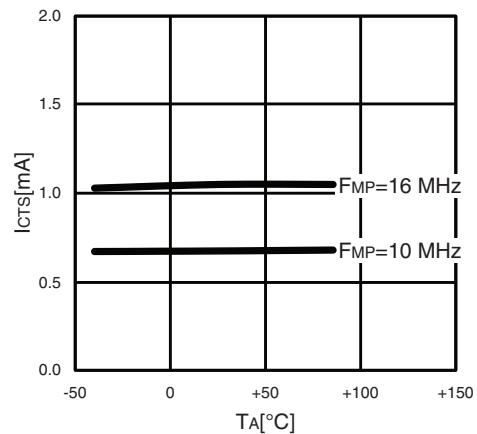

(Continued)

(Continued)

**IcCH - Vcc**  
 TA=+25°C, FMPL=(stop)  
 Substop mode with the external clock stopping

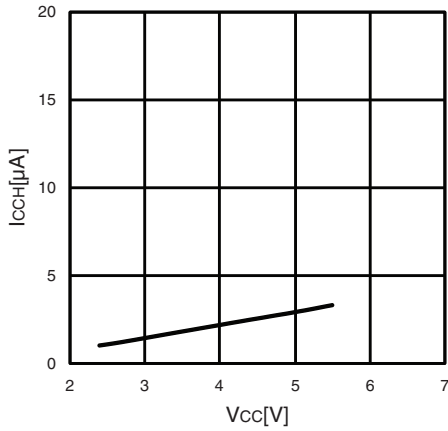

**IcCH - TA**  
 V=5.5 V, FMPL=(stop)  
 Substop mode with the external clock stopping

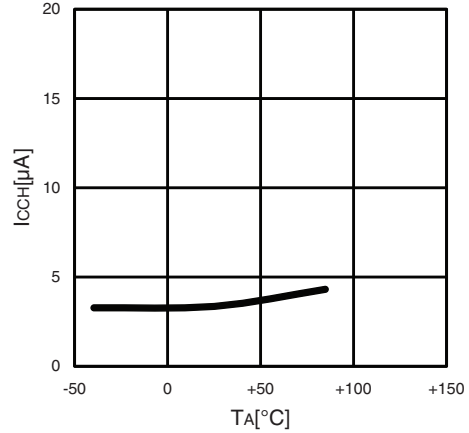

**ICCMCR - Vcc**  
 TA=+25°C, FMPL=1, 8, 10 MHz (no division)  
 Main clock mode with the internal main CR clock operating

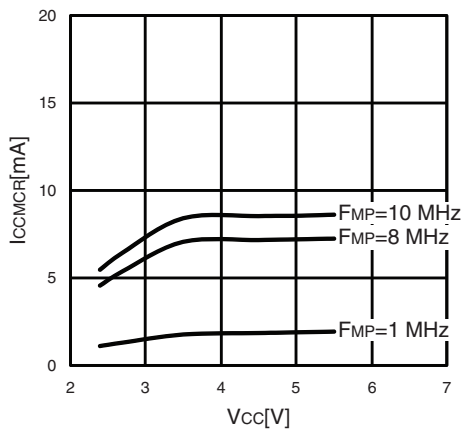

**ICCMCR - TA**  
 V=5.5 V, FMPL=1, 8, 10 MHz (no division)  
 Main clock mode with the internal main CR clock operating

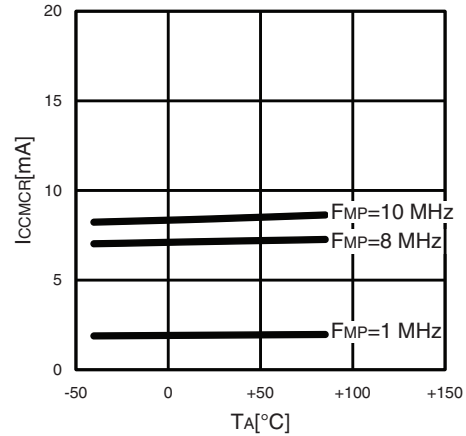

**ICCSSCR - Vcc**  
 TA=+25°C, FMPL=50 kHz (divided by 2)  
 Subclock mode with the internal sub-CR clock operating

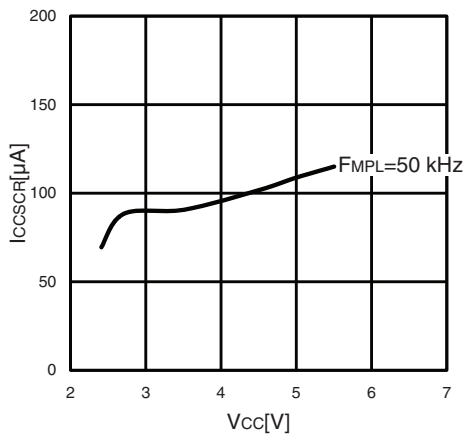

**ICCSSCR - TA**  
 Vcc=5.5 V, FMPL=50 kHz (divided by 2)  
 Subclock mode with the internal sub-CR clock operating

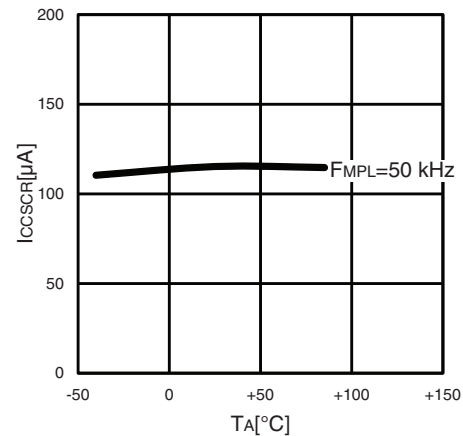

**Input voltage**

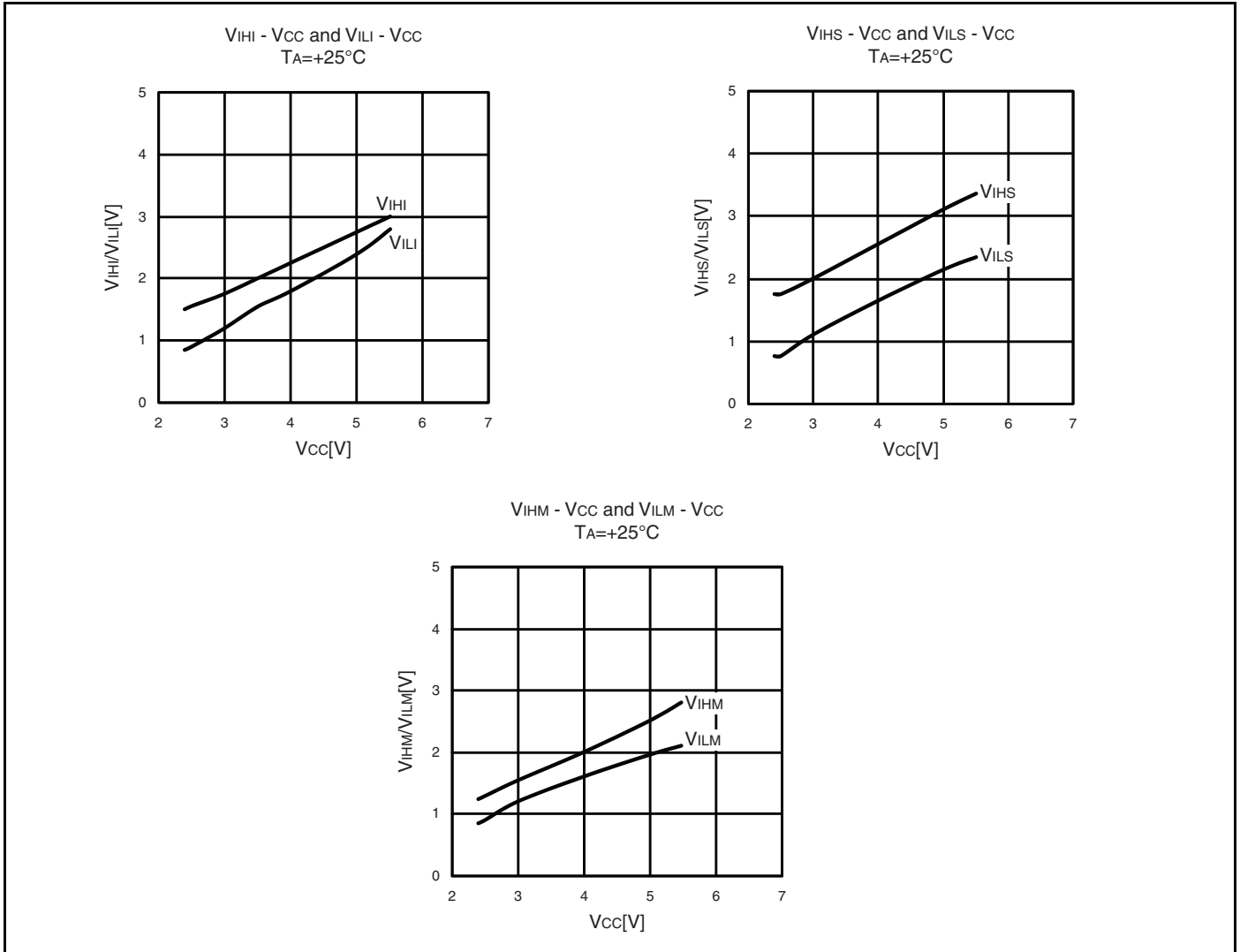

Output voltage

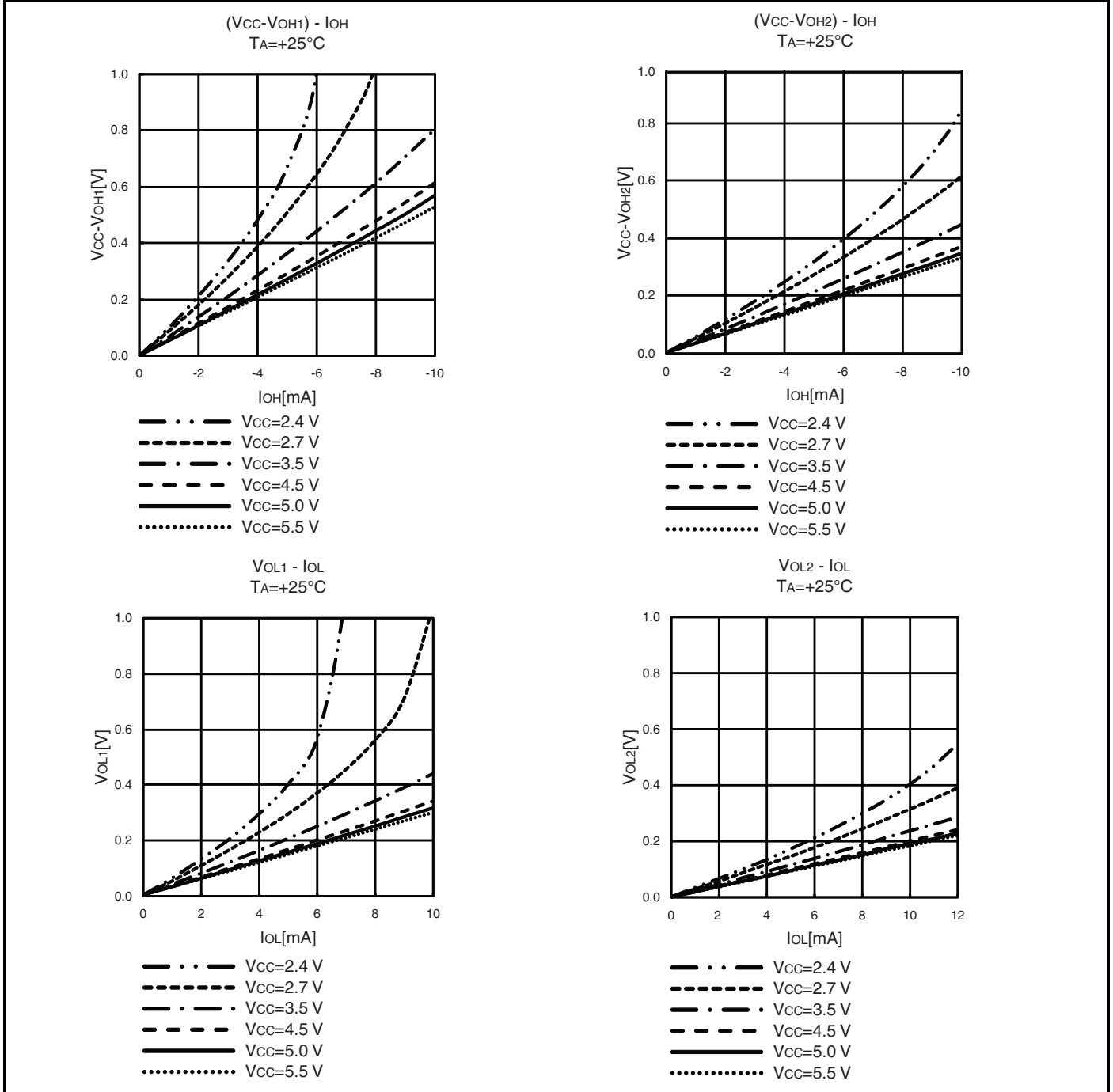

Pull-up

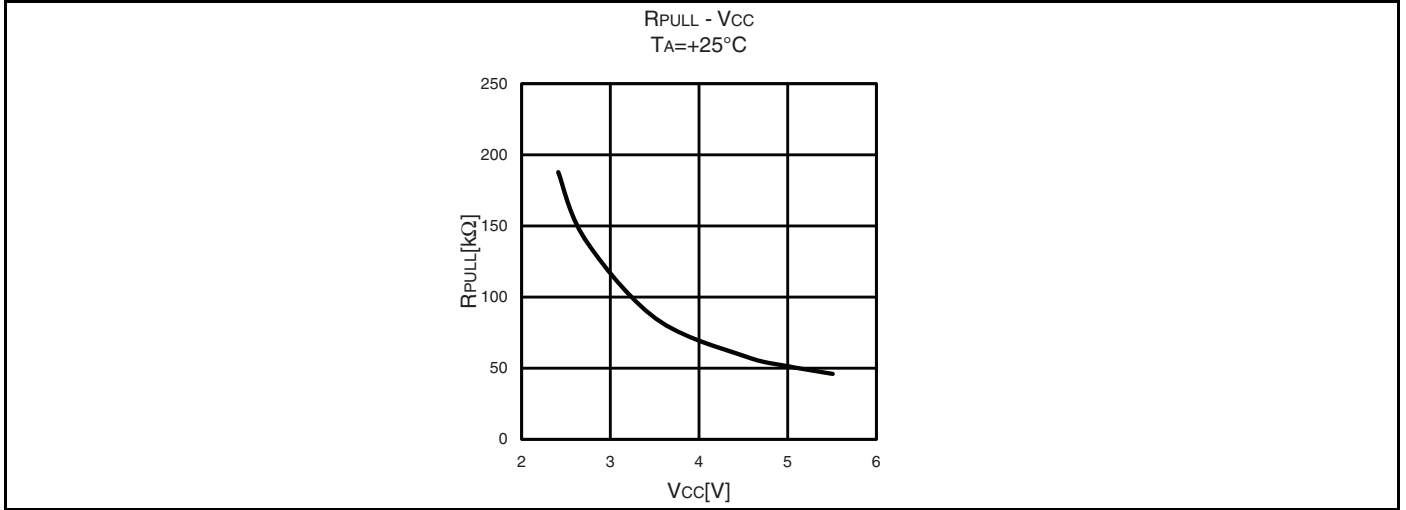

**20. Mask Options**

No.	Part Number	MB95F204H MB95F203H MB95F202H MB95F214H MB95F213H MB95F212H	MB95F204K MB95F203K MB95F202K MB95F214K MB95F213K MB95F212K
	Selection Method	Setting disabled	Setting disabled
1	Low-voltage detection reset •With low-voltage detection reset •Without low-voltage detection reset	Without low-voltage detection reset	With low-voltage detection reset
2	Reset •With dedicated reset input •Without dedicated reset input	With dedicated reset input	Without dedicated reset input

**21. Ordering Information**

Part Number	Package
MB95F204HP-G-SH-SNE2 MB95F204KP-G-SH-SNE2 MB95F203HP-G-SH-SNE2 MB95F203KP-G-SH-SNE2 MB95F202HP-G-SH-SNE2 MB95F202KP-G-SH-SNE2	24-pin plastic SDIP (DIP-24P-M07)
MB95F204HPF-G-SNE2 MB95F204KPF-G-SNE2 MB95F203HPF-G-SNE2 MB95F203KPF-G-SNE2 MB95F202HPF-G-SNE2 MB95F202KPF-G-SNE2	20-pin plastic SOP (FPT-20P-M09)
MB95F214HPH-G-SNE2 MB95F214KPH-G-SNE2 MB95F213HPH-G-SNE2 MB95F213KPH-G-SNE2 MB95F212HPH-G-SNE2 MB95F212KPH-G-SNE2	8-pin plastic DIP (DIP-8P-M03)
MB95F214HPF-G-SNE2 MB95F214KPF-G-SNE2 MB95F213HPF-G-SNE2 MB95F213KPF-G-SNE2 MB95F212HPF-G-SNE2 MB95F212KPF-G-SNE2	8-pin plastic SOP (FPT-8P-M08)

**22. Package Dimensions**

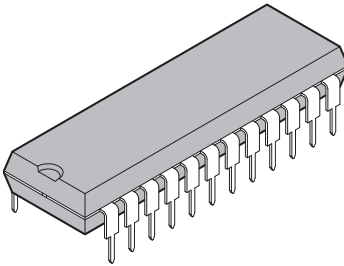
<p>24-pin plastic SDIP</p>  <p>(DIP-24P-M07)</p>	Lead pitch	1.778 mm	
	Package width × package length	6.40 mm × 22.86 mm	
	Sealing method	Plastic mold	
	Mounting height	4.80 mm Max	

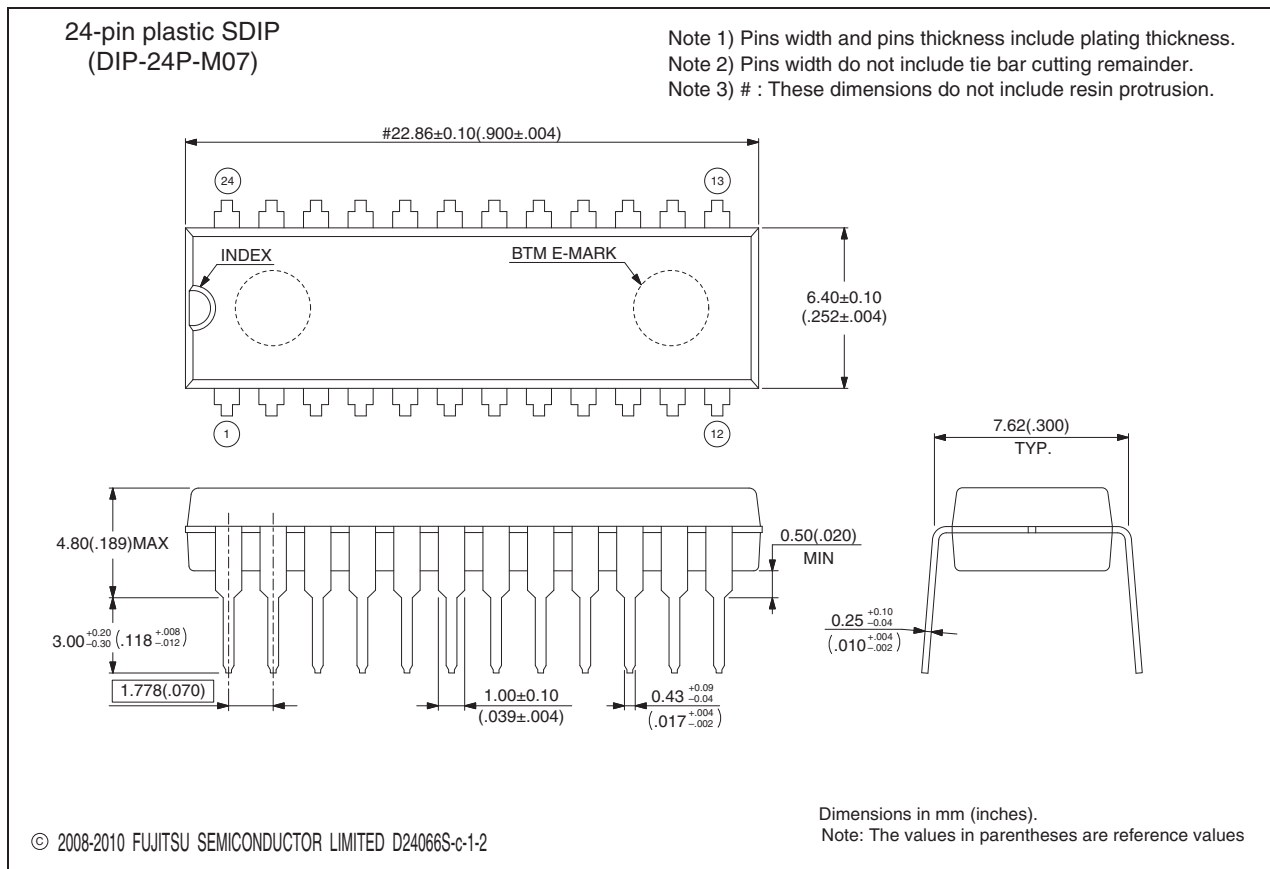

(Continued)

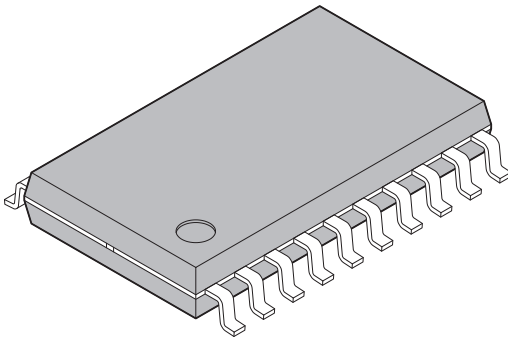
<p>20-pin plastic SOP</p>  <p>(FPT-20P-M09)</p>	Lead pitch	1.27 mm
	Package width × package length	7.50 mm × 12.70 mm
	Lead shape	Gullwing
	Lead bend direction	Normal bend
	Sealing method	Plastic mold
	Mounting height	2.65 mm Max

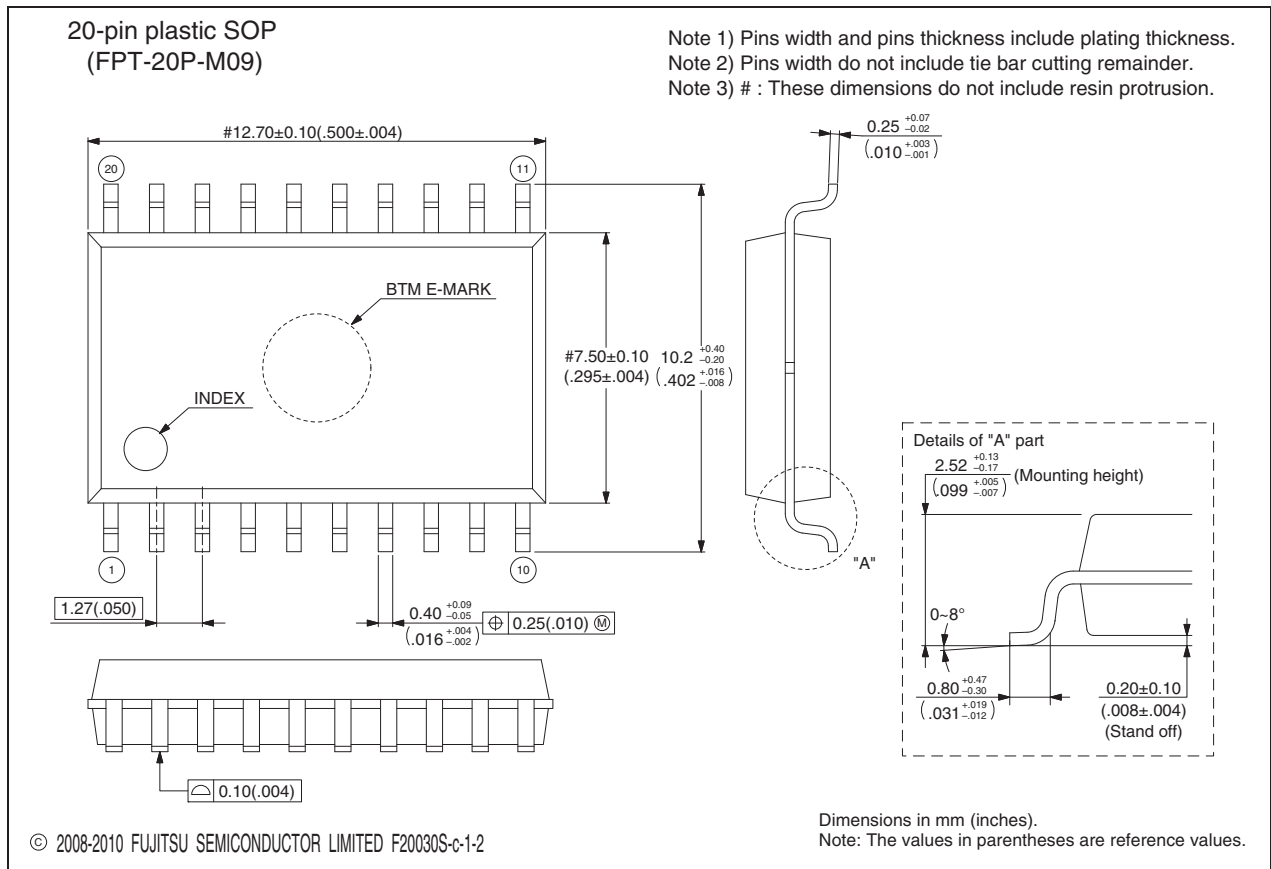

(Continued)

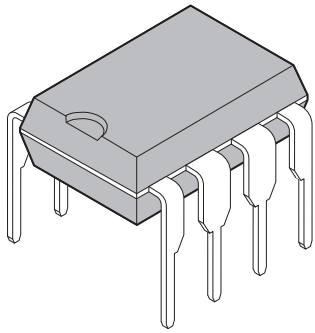
<p>8-pin plastic DIP</p>  <p>(DIP-8P-M03)</p>	Lead pitch	2.54 mm
	Sealing method	Plastic mold

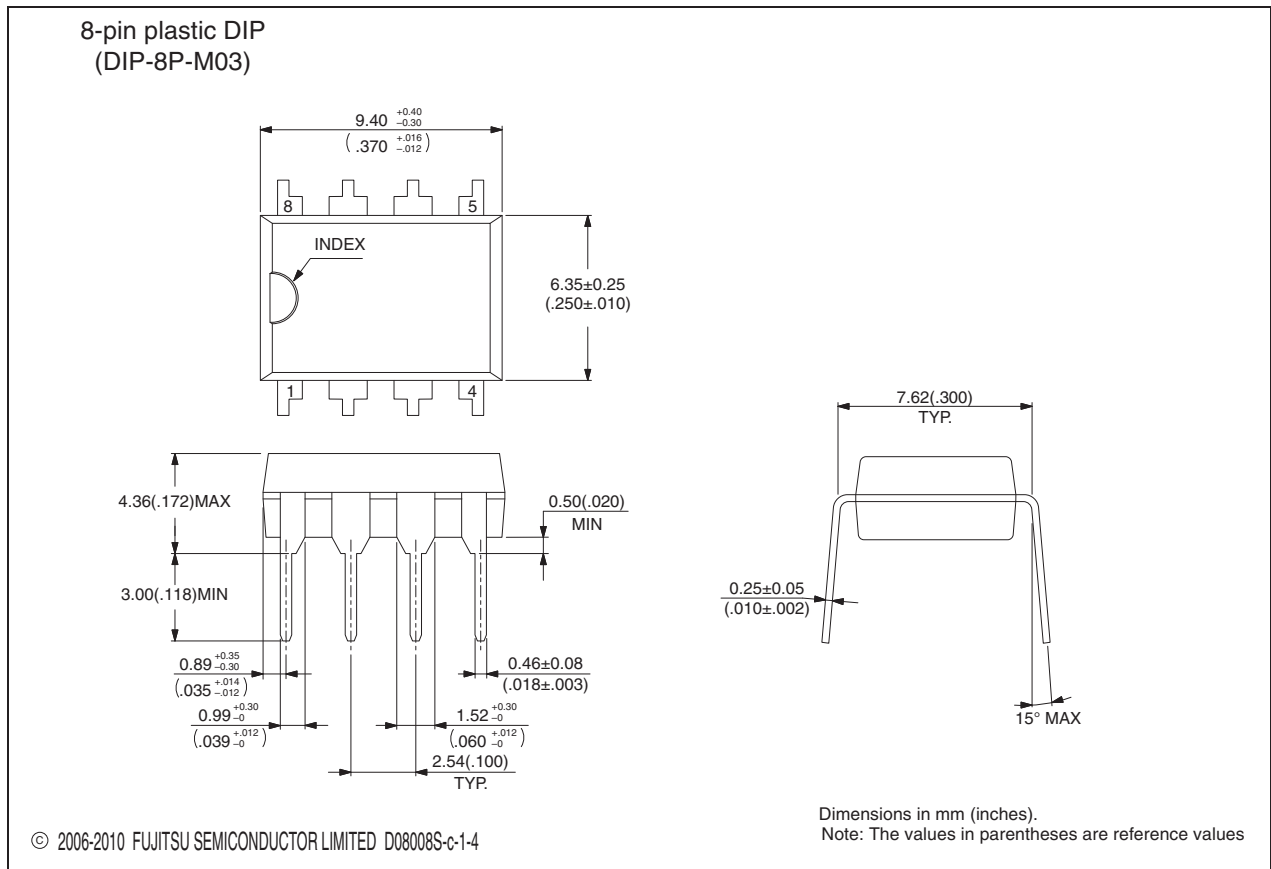

(Continued)

(Continued)

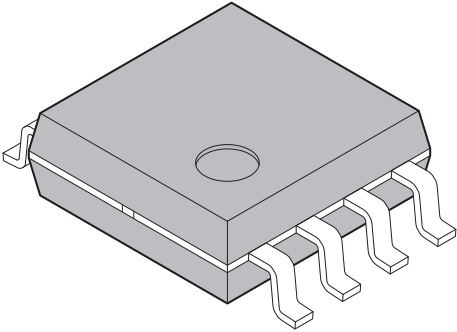
<p style="text-align: center;">8-pin plastic SOP</p>  <p style="text-align: center;">(FPT-8P-M08)</p>	Lead pitch	1.27 mm
	Package width × package length	5.30 mm × 5.24 mm
	Lead shape	Gullwing
	Lead bend direction	Normal bend
	Sealing method	Plastic mold
	Mounting height	2.10 mm Max

8-pin plastic SOP  
(FPT-8P-M08)

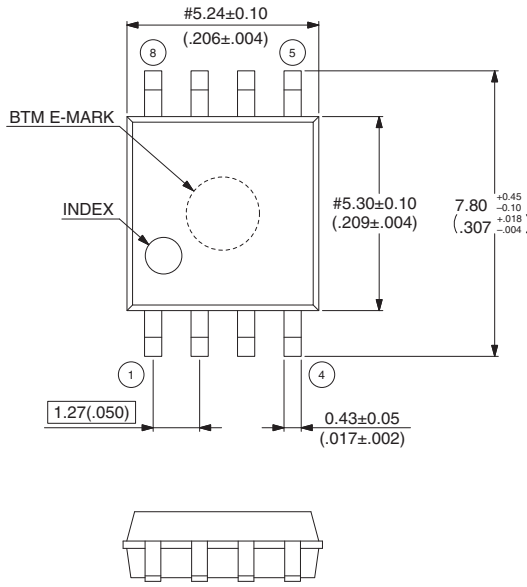

Note 1) Pins width and pins thickness include plating thickness.  
 Note 2) Pins width do not include tie bar cutting remainder.  
 Note 3) # : These dimensions do not include resin protrusion.

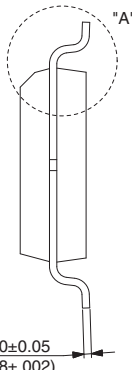

Details of "A" part

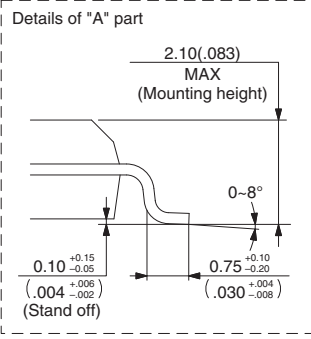

2.10(.083)  
MAX  
(Mounting height)

0-8°

0.10 (+0.15/-0.05)  
(.004 (+0.006/-0.002))  
(Stand off)

0.75 (+0.10/-0.20)  
(.030 (+0.004/-0.008))

© 2008-2010 FUJITSU SEMICONDUCTOR LIMITED F08016S-c-1-2

Dimensions in mm (inches).  
 Note: The values in parentheses are reference values.

## 23. Major Changes

Spansion Publication Number: DS07-12623-5E

Page	Section	Change results
30	Electrical Characteristics 1. Absolute Maximum Ratings	Changed the characteristics of Input voltage.
33	3. DC Characteristics	Corrected the maximum value of "H" level input voltage for PF2 pin. $V_{CC} + 0.3 \rightarrow 10.5$
		Corrected the maximum value of Open-drain output application voltage. $0.2V_{CC} \rightarrow V_{SS} + 5.5$
36		Added the footnote *5.
39	4. AC Characteristics (1) Clock Timing	Added a figure of HCLK1/HCLK2.
42	(2) Source Clock/Machine Clock	Corrected the graph of Operating voltage - Operating frequency (with the on-chip debug function). (Corrected the pitch)
43	(3) External Reset	Added "and power on" to the remarks column.
58	6. Flash Memory Program/Erase Characteristics	Added the row of "Current drawn on PF2".
		Corrected the minimum value of Power supply voltage at erase/program. $4.5 \rightarrow 3.0$

**Note:** Please see "Document History" about later revised information.

## Document History

Document Title: MB95200H/210H Series F <sup>2</sup> MC-8FX 8-bit Microcontroller Document Number: 002-07463				
Revision	ECN	Orig. of Change	Submission Date	Description of Change
**	–	AKIH	07/16/2010	Migrated to Cypress and assigned document number 002-07463. No change to document contents or format.
*A	5177811	AKIH	03/18/2016	Updated to Cypress format.

## Sales, Solutions, and Legal Information

### Worldwide Sales and Design Support

Cypress maintains a worldwide network of offices, solution centers, manufacturer's representatives, and distributors. To find the office closest to you, visit us at [Cypress Locations](#).

#### Products

ARM® Cortex® Microcontrollers	<a href="http://cypress.com/arm">cypress.com/arm</a>
Automotive	<a href="http://cypress.com/automotive">cypress.com/automotive</a>
Clocks & Buffers	<a href="http://cypress.com/clocks">cypress.com/clocks</a>
Interface	<a href="http://cypress.com/interface">cypress.com/interface</a>
Lighting & Power Control	<a href="http://cypress.com/powerpsoc">cypress.com/powerpsoc</a>
Memory	<a href="http://cypress.com/memory">cypress.com/memory</a>
PSoC	<a href="http://cypress.com/psoc">cypress.com/psoc</a>
Touch Sensing	<a href="http://cypress.com/touch">cypress.com/touch</a>
USB Controllers	<a href="http://cypress.com/usb">cypress.com/usb</a>
Wireless/RF	<a href="http://cypress.com/wireless">cypress.com/wireless</a>

#### PSoC® Solutions

[cypress.com/psoc](http://cypress.com/psoc)  
PSoC 1 | PSoC 3 | PSoC 4 | PSoC 5LP

#### Cypress Developer Community

[Community](#) | [Forums](#) | [Blogs](#) | [Video](#) | [Training](#)

#### Technical Support

[cypress.com/support](http://cypress.com/support)



© Cypress Semiconductor Corporation 2008-2016. This document is the property of Cypress Semiconductor Corporation and its subsidiaries, including Spansion LLC ("Cypress"). This document, including any software or firmware included or referenced in this document ("Software"), is owned by Cypress under the intellectual property laws and treaties of the United States and other countries worldwide. Cypress reserves all rights under such laws and treaties and does not, except as specifically stated in this paragraph, grant any license under its patents, copyrights, trademarks, or other intellectual property rights. If the Software is not accompanied by a license agreement and you do not otherwise have a written agreement with Cypress governing the use of the Software, then Cypress hereby grants you under its copyright rights in the Software, a personal, non-exclusive, nontransferable license (without the right to sublicense) (a) for Software provided in source code form, to modify and reproduce the Software solely for use with Cypress hardware products, only internally within your organization, and (b) to distribute the Software in binary code form externally to end users (either directly or indirectly through resellers and distributors), solely for use on Cypress hardware product units. Cypress also grants you a personal, non-exclusive, nontransferable, license (without the right to sublicense) under those claims of Cypress's patents that are infringed by the Software (as provided by Cypress, unmodified) to make, use, distribute, and import the Software solely to the minimum extent that is necessary for you to exercise your rights under the copyright license granted in the previous sentence. Any other use, reproduction, modification, translation, or compilation of the Software is prohibited.

CYPRESS MAKES NO WARRANTY OF ANY KIND, EXPRESS OR IMPLIED, WITH REGARD TO THIS DOCUMENT OR ANY SOFTWARE, INCLUDING, BUT NOT LIMITED TO, THE IMPLIED WARRANTIES OF MERCHANTABILITY AND FITNESS FOR A PARTICULAR PURPOSE. Cypress reserves the right to make changes to this document without further notice. Cypress does not assume any liability arising out of the application or use of any product or circuit described in this document. Any information provided in this document, including any sample design information or programming code, is provided only for reference purposes. It is the responsibility of the user of this document to properly design, program, and test the functionality and safety of any application made of this information and any resulting product. Cypress products are not designed, intended, or authorized for use as critical components in systems designed or intended for the operation of weapons, weapons systems, nuclear installations, life-support devices or systems, other medical devices or systems (including resuscitation equipment and surgical implants), pollution control or hazardous substances management, or other uses where the failure of the device or system could cause personal injury, death, or property damage ("Unintended Uses"). A critical component is any component of a device or system whose failure to perform can be reasonably expected to cause the failure of the device or system, or to affect its safety or effectiveness. Cypress is not liable, in whole or in part, and Company shall and hereby does release Cypress from any claim, damage, or other liability arising from or related to all Unintended Uses of Cypress products. Company shall indemnify and hold Cypress harmless from and against all claims, costs, damages, and other liabilities, including claims for personal injury or death, arising from or related to any Unintended Uses of Cypress products.





Cypress, the Cypress logo, Spansion, the Spansion logo, and combinations thereof, PSoC, CapSense, EZ-USB, F-RAM, and Traveo are trademarks or registered trademarks of Cypress in the United States and other countries. For a more complete list of Cypress trademarks, visit [cypress.com](http://cypress.com). Other names and brands may be claimed as property of their respective owners.

## Looking for pricing, stock, or lifecycle information?

Click below to explore more details on WIN SOURCE:

-  [View MB95F204HP-G-SH-SNE2 on WIN SOURCE](#)
-  [Infineon Technologies](#) Information

## Optimize Your Supply Chain with WIN SOURCE Solutions

-  Global Sourcing Solution
-  Obsolete Management
-  Cost Control Management
-  Shortage Management
-  Alternative Solution
-  Excess Inventory Management