

Tiny, Low-Cost, Single/Dual-Input, Fixed-Gain Microphone Amplifiers with Integrated Bias

General Description

The MAX9812/MAX9813 are single/dual-input, 20dB fixed-gain microphone amplifiers. They offer tiny packaging and a low-noise, integrated microphone bias, making them ideal for portable audio applications such as notebook computers, cell phones, and PDAs. These amplifiers feature a 500kHz bandwidth, rail-to-rail outputs, an industry-leading 100dB power-supply rejection ratio, and a very low 0.015% THD+N. Power-saving features include very low 230µA supply current and a total shutdown mode that cuts the combined supply and BIAS currents to only 100nA.

The MAX9812 is a single amplifier in a 6-pin SC70 package (2mm x 2.1mm) and the MAX9813 is a dual-input amplifier available in an 8-pin SOT23 (3mm x 3mm) package. The MAX9813 has two inputs allowing two microphones to be multiplexed to a single output.

The MAX9812/MAX9813 are offered in two grades. The MAX9812L/MAX9813L are optimized for 3.3V supply operation (2.7V to 3.6V). The MAX9812H/MAX9813H are PC2001 compliant and are optimized for 5V operation (4.5V to 5.5V). Both devices are specified over the -40°C to +85°C extended operating temperature range.

Applications

- Notebook Computers
- PDAs
- Smart Phones
- Digital Cameras
- Video Tape Recorders

Features

- ◆ PC2001 Compliant
- ◆ 100dB at 217Hz Power-Supply Rejection Ratio
- ◆ Very Low 230µA Quiescent Current
- ◆ Low 0.015% THD+N
- ◆ Available in Two Versions
 MAX9812L/MAX9813L—2.7V to 3.6V
 MAX9812H/MAX9813H—4.5V to 5.5V
- ◆ Internal Low-Noise Microphone Bias Supply
 2.3V for MAX9812L/MAX9813L
 4.0V for MAX9812H/MAX9813H
- ◆ 100nA Low-Power Shutdown Mode
- ◆ Rail-to-Rail Outputs
- ◆ 20dB Fixed Gain
- ◆ Available in Tiny 6-Pin SC70 (2mm x 2.1mm) and 8-Pin SOT23 (3mm x 3mm) Packages
- ◆ Extended Temperature Range -40°C to +85°C

Ordering Information

| PART | TEMP RANGE | PIN-PACKAGE | V _{CC} (V) |
|---------------|----------------|-------------|---------------------|
| MAX9812LEXT+T | -40°C to +85°C | 6 SC70 | 2.7 to 3.6 |
| MAX9812HEXT+T | -40°C to +85°C | 6 SC70 | 4.5 to 5.5 |
| MAX9813LEKA+T | -40°C to +85°C | 8 SOT23 | 2.7 to 3.6 |
| MAX9813HEKA+T | -40°C to +85°C | 8 SOT23 | 4.5 to 5.5 |

+Denotes a lead(Pb)-free/RoHS-compliant package.

Pin Configurations, Selector Guide, and Typical Operating Circuits appear at end of data sheet.

Simplified Block Diagrams

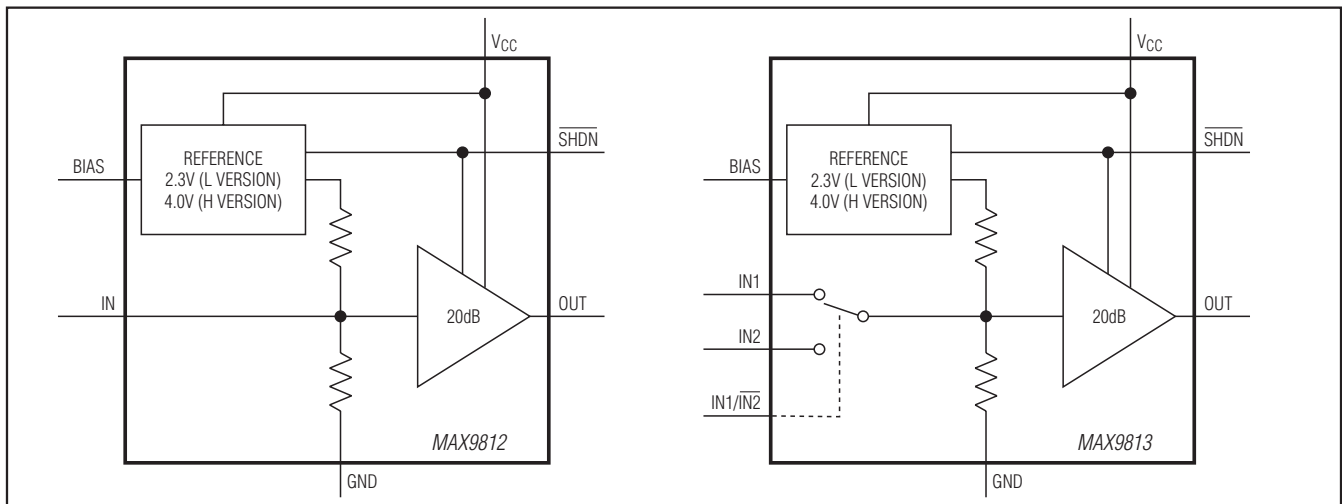

For pricing, delivery, and ordering information, please contact Maxim Direct at 1-888-629-4642, or visit Maxim's website at www.maximintegrated.com.

MAX9812/MAX9813

Tiny, Low-Cost, Single/Dual-Input, Fixed-Gain Microphone Amplifiers with Integrated Bias

ABSOLUTE MAXIMUM RATINGS

(All voltages referenced to GND.)

| | |
|--|-----------------------------------|
| V _{CC} | -0.3V to +6.0V |
| All Other Pins..... | -0.3V to (V _{CC} + 0.3V) |
| Continuous Current (I _N , $\overline{\text{SHDN}}$, I _{N1} , I _{N2} , I _{N1/IN2})..... | ±20mA |
| OUT, BIAS Short-Circuit Duration (to GND or V _{CC}) ... | Continuous |
| Continuous Power Dissipation (T _A = +70°C) | |
| SC70 (derate 3.1mW/°C above +70°C) | 245mW |
| SOT23 (derate 8.9mW/°C above +70°C) | 714mW |

| | |
|---|-----------------|
| Operating Temperature Range | -40°C to +85°C |
| Storage Temperature Range | -65°C to +150°C |
| Junction Temperature | +150°C |
| Lead Temperature (soldering, 10s) | +300°C |
| Soldering Temperature (reflow) | +260°C |

Stresses beyond those listed under "Absolute Maximum Ratings" may cause permanent damage to the device. These are stress ratings only, and functional operation of the device at these or any other conditions beyond those indicated in the operational sections of the specifications is not implied. Exposure to absolute maximum rating conditions for extended periods may affect device reliability.

ELECTRICAL CHARACTERISTICS

(V_{CC} = 3.3V, I_{BIAS} = 500μA (MAX9812L/MAX9813L), V_{CC} = 5V, I_{BIAS} = 800μA (MAX9812H/MAX9813H), V_{GND} = 0V, R_L = open, $\overline{\text{SHDN}}$ = V_{CC}, T_A = T_{MIN} to T_{MAX}, unless otherwise noted. Typical values are at T_A = +25°C.) (Note 1)

| PARAMETER | SYMBOL | CONDITIONS | MIN | TYP | MAX | UNITS | |
|----------------------------------|----------------------|---|-------------------------|------------------------|------|-------|---|
| GENERAL | | | | | | | |
| Supply Voltage Range | V _{CC} | MAX9812L/MAX9813L | Inferred from | 2.7 | 3.6 | V | |
| | | MAX9812H/MAX9813H | PSRR test | 4.5 | 5.5 | | |
| Supply Current | I _{CC} | I _{BIAS} = 0A | | 230 | 400 | μA | |
| Shutdown Supply Current | I _{CC_SHDN} | $\overline{\text{SHDN}}$ = GND | | 0.1 | 1 | μA | |
| Amplifier Output Bias Voltage | V _{OUT_DC} | MAX9812L/MAX9813L | | 1.35 | 1.5 | 1.65 | V |
| | | MAX9812H/MAX9813H | | 2.25 | 2.5 | 2.75 | |
| Input Resistance | R _{IN} | | | 85 | | kΩ | |
| Voltage Gain | A _v | | 19 | 20 | 21 | dB | |
| Power-Supply Rejection Ratio | PSRR _{OUT} | Input referred, T _A = +25°C | DC | 90 | 100 | dB | |
| | | | f = 217Hz | | 100 | | |
| | | | f = 1kHz | | 100 | | |
| | | | f = 10kHz | | 90 | | |
| Output Voltage Swing | V _{OH} | R _L = 10kΩ to V _{CC} /2 | | V _{CC} - 0.1 | | V | |
| | | R _L = 1kΩ to V _{CC} /2 | V _{CC} - 0.25V | V _{CC} - 0.1V | | | |
| | V _{OL} | R _L = 10kΩ to V _{CC} /2 | | 0.1 | | | |
| | | R _L = 1kΩ to V _{CC} /2 | | 0.1 | 0.25 | | |
| Output Short-Circuit Current | I _{OUT_SC} | Sinking or sourcing | 3 | 12 | 24 | mA | |
| Small-Signal -3dB Bandwidth | BW | V _{OUT} = 10mV _{P-P} | | 400 | | kHz | |
| Output Capacitive-Load Stability | C _L | No sustained oscillations | | 50 | | pF | |
| Output Impedance | Z _{OUT} | f = 1kHz | | 0.5 | | Ω | |
| Output Slew Rate | SR | V _{OUT} = 1V step | | 1 | | V/μs | |

MAX9812/MAX9813

Tiny, Low-Cost, Single/Dual-Input, Fixed-Gain Microphone Amplifiers with Integrated Bias

ELECTRICAL CHARACTERISTICS (continued)

($V_{CC} = 3.3V$, $I_{BIAS} = 500\mu A$ (MAX9812L/MAX9813L), $V_{CC} = 5V$, $I_{BIAS} = 800\mu A$ (MAX9812H/MAX9813H), $V_{GND} = 0V$, $R_L = \text{open}$, $SHDN = V_{CC}$, $T_A = T_{MIN}$ to T_{MAX} , unless otherwise noted. Typical values are at $T_A = +25^\circ C$.) (Note 1)

| PARAMETER | SYMBOL | CONDITIONS | | MIN | TYP | MAX | UNITS |
|---|----------------------|---|----------------------------------|-----|-------|---------|----------------|
| Amplifier Input Voltage-Noise Density | e_n | Inputs at AC GND | $f = 1kHz$ | | 40 | | nV/\sqrt{Hz} |
| Total Integrated Input Noise | V_n | 22Hz to 22kHz BW, inputs at AC GND | | | 5 | | μV_{RMS} |
| Off-Isolation | | Input referred, MAX9813 only | 1kHz | | 75 | | dB |
| | | | 10kHz | | 60 | | |
| Total Harmonic Distortion Plus Noise | THD+N | $f = 1kHz$, $R_L = 10k\Omega$ to $V_{CC}/2$, BW = 22Hz to 22kHz | $V_{OUT} = 1V_{P-P}$ (L version) | | 0.04 | | % |
| | | | $V_{OUT} = 4V_{P-P}$ (H version) | | 0.015 | | |
| BIAS | | | | | | | |
| Bias Output Voltage Range | V_{BIAS} | MAX9812L/MAX9813L | | 2.1 | 2.30 | 2.55 | V |
| | | MAX9812H/MAX9813H | | 3.6 | 4.0 | 4.4 | |
| Bias Output Resistance | R_{BIAS} | | | | 0.1 | | Ω |
| Power-Supply Rejection Ratio (V_{CC} to BIAS) | PSRR _{BIAS} | DC, $T_A = +25^\circ C$ | | 70 | 80 | | dB |
| | | $f = 217Hz$ | | | 80 | | |
| | | $f = 1kHz$ | | | 75 | | |
| | | $f = 10kHz$ | | | 55 | | |
| BIAS Current Limit | I_{BIAS_SC} | BIAS short to GND | | 5 | 22 | 50 | mA |
| BIAS Capacitive-Load Stability | C_{BIAS} | No sustained oscillations | | | 50 | | pF |
| Total Integrated BIAS Noise | V_n | 22Hz to 22kHz BW | | | 29 | | μV_{RMS} |
| DIGITAL INPUTS (\overline{SHDN}, $\overline{IN1}$/$\overline{IN2}$) | | | | | | | |
| Logic-Low Threshold | V_{IL} | | | | | 0.8 | V |
| Logic-High Threshold | V_{IH} | | | 2.0 | | | V |
| Logic Input Current | I_{IN} | $\overline{SHDN} = GND$ or V_{CC} | | | | ± 1 | μA |
| Shutdown Enable Time | t_{SHDN_ON} | 95% of settled value | | | 10 | | ms |
| Shutdown Disable Time | t_{SHDN_OFF} | | | | 50 | | μs |
| $\overline{IN1}/\overline{IN2}$ Select Time | t_{SEL} | | | | 10 | | μs |

Note 1: All specifications are 100% tested at $T_A = +25^\circ C$. Temperature limits are guaranteed by design.

MAX9812/MAX9813

Tiny, Low-Cost, Single/Dual-Input, Fixed-Gain Microphone Amplifiers with Integrated Bias

Typical Operating Characteristics

($V_{CC} = 3.3V$ (MAX9812L/MAX9813L), $V_{CC} = 5V$ (MAX9812H/MAX9813H), $V_{GND} = 0V$, $R_L = 10k\Omega$ to $V_{CC}/2$, $SHDN = V_{CC}$, $T_A = +25^\circ C$, unless otherwise noted.)

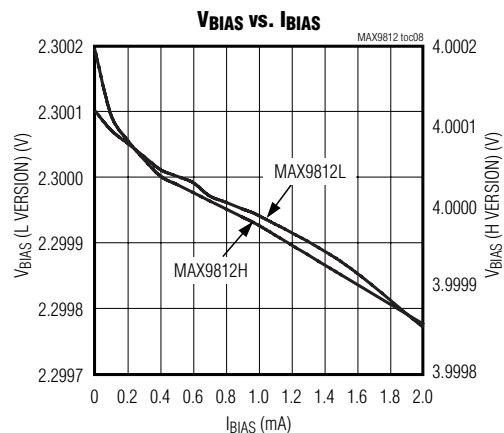
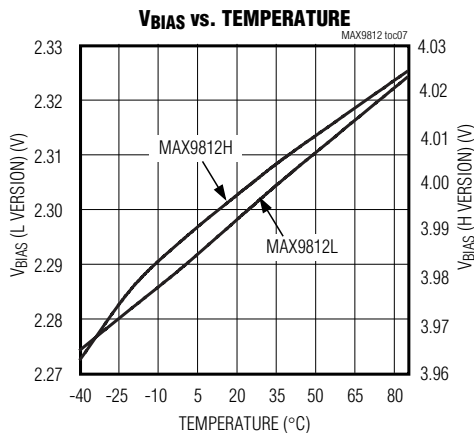
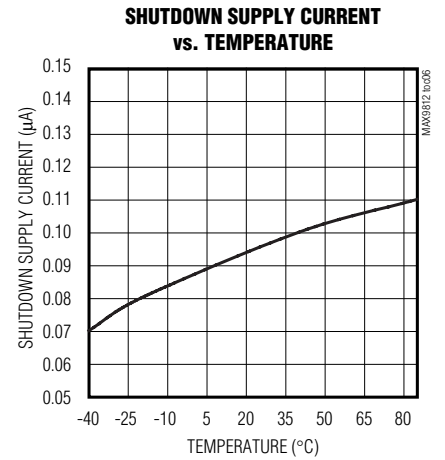
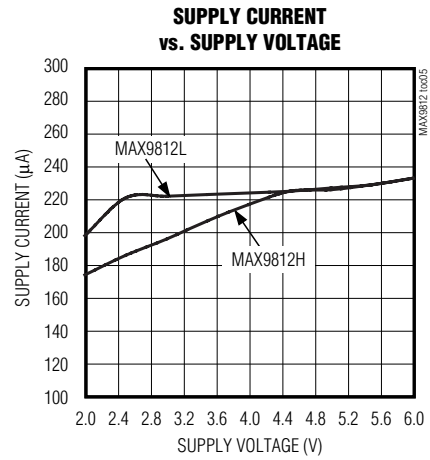
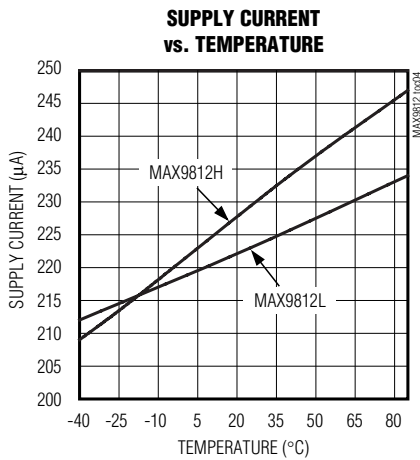
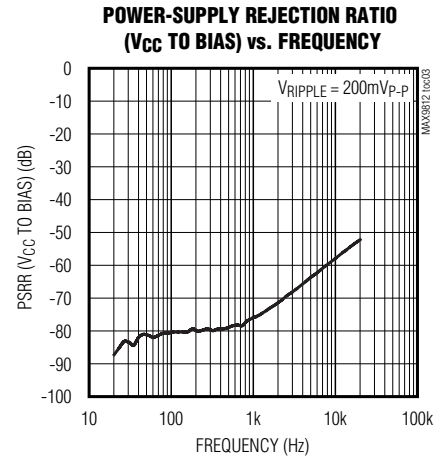
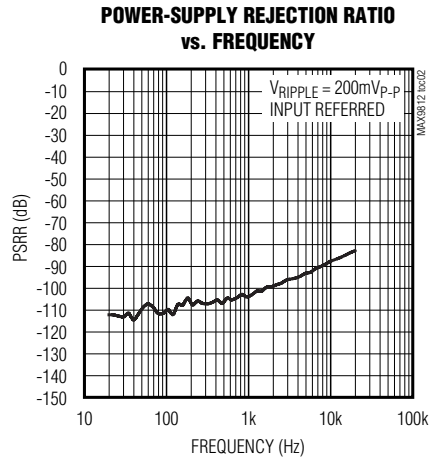
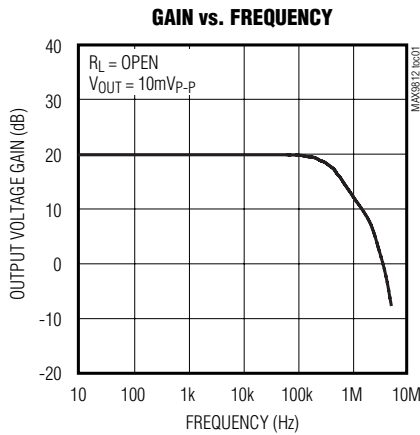

MAX9812/MAX9813

Tiny, Low-Cost, Single/Dual-Input, Fixed-Gain Microphone Amplifiers with Integrated Bias

Typical Operating Characteristics (continued)

($V_{CC} = 3.3V$ (MAX9812L/MAX9813L), $V_{CC} = 5V$ (MAX9812H/MAX9813H), $V_{GND} = 0V$, $R_L = 10k\Omega$ to $V_{CC}/2$, $SHDN = V_{CC}$, $T_A = +25^\circ C$, unless otherwise noted.)

TOTAL HARMONIC DISTORTION PLUS NOISE vs. FREQUENCY

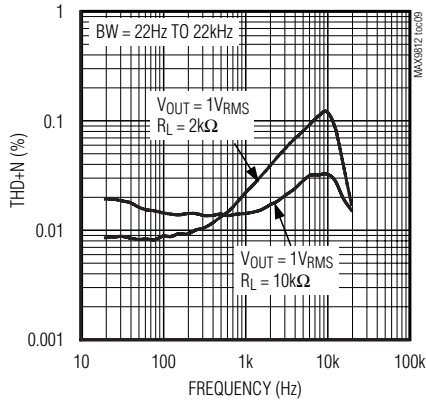

TOTAL HARMONIC DISTORTION PLUS NOISE vs. OUTPUT AMPLITUDE

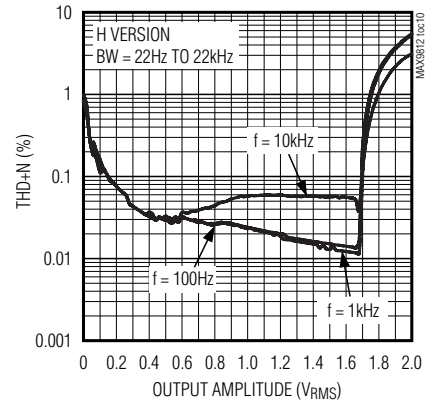

TOTAL HARMONIC DISTORTION PLUS NOISE vs. OUTPUT AMPLITUDE

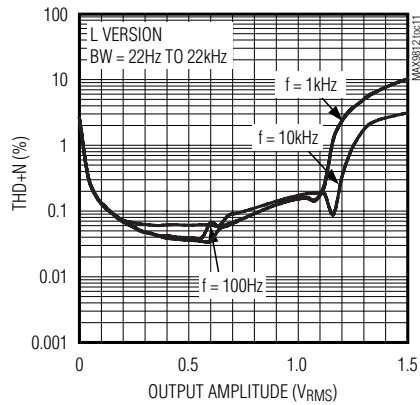

INPUT-REFERRED NOISE vs. FREQUENCY

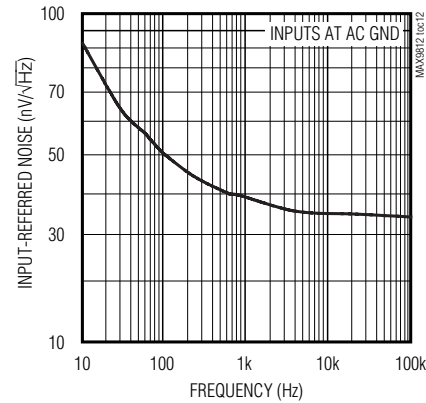

BIAS NOISE vs. FREQUENCY

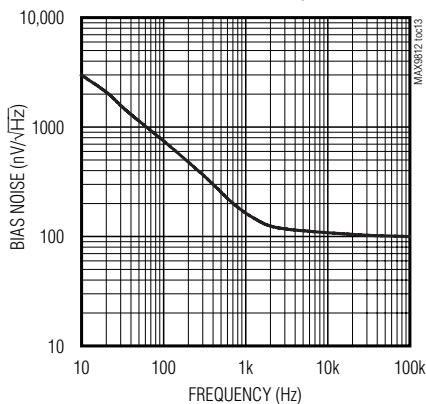

OFF-ISOLATION vs. FREQUENCY

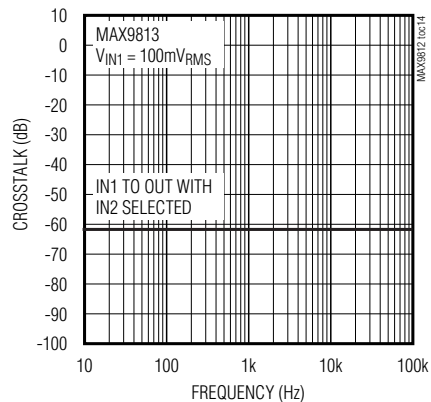

MAX9812/MAX9813

Tiny, Low-Cost, Single/Dual-Input, Fixed-Gain Microphone Amplifiers with Integrated Bias

Typical Operating Characteristics (continued)

($V_{CC} = 3.3V$ (MAX9812L/MAX9813L), $V_{CC} = 5V$ (MAX9812H/MAX9813H), $V_{GND} = 0V$, $R_L = 10k\Omega$ to $V_{CC}/2$, $SHDN = V_{CC}$, $T_A = +25^\circ C$, unless otherwise noted.)

SMALL-SIGNAL PULSE RESPONSE
($R_L = OPEN, C_L = 10pF$)

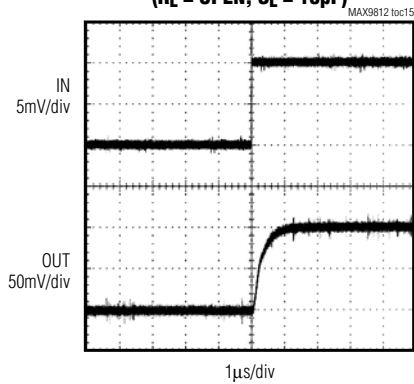

LARGE-SIGNAL PULSE RESPONSE
($R_L = OPEN, C_L = 10pF$)

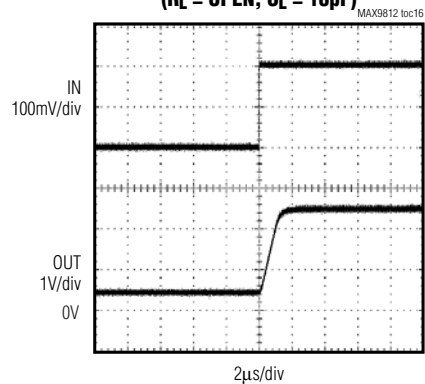

OUT-OF-SHUTDOWN WAVEFORM
INPUT UNCONNECTED

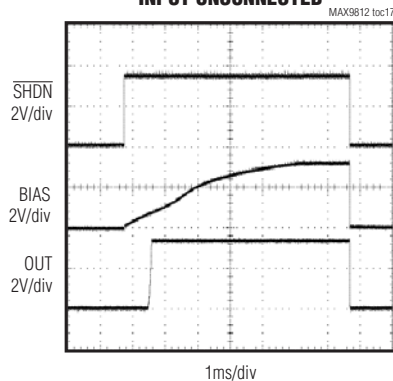

MAX9813
SWITCHING BETWEEN TWO INPUTS

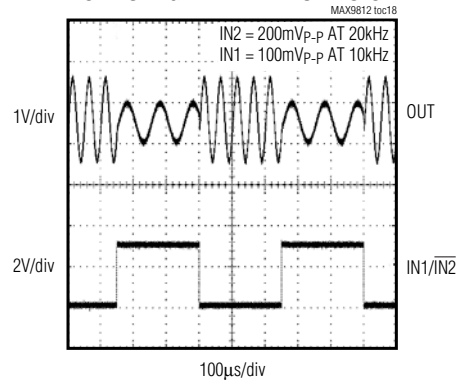

OUTPUT OVERDRIVEN

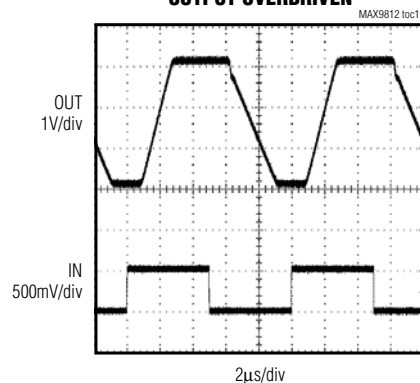

MAX9812/MAX9813

Tiny, Low-Cost, Single/Dual-Input, Fixed-Gain Microphone Amplifiers with Integrated Bias

Pin Description

| PIN | | NAME | FUNCTION |
|-----------------------|-----------------------|------------------------------|---|
| MAX9812L/ MAX9812H | MAX9813L/ MAX9813H | | |
| 1 | 3 | $\overline{\text{SHDN}}$ | Active-Low Shutdown Input. Connect $\overline{\text{SHDN}}$ to V_{CC} for normal operation. Connect $\overline{\text{SHDN}}$ to GND for shutdown. $\overline{\text{SHDN}}$ is a high-impedance input; do not leave unconnected. |
| 2 | 2 | GND | Ground |
| 3 | 1 | OUT | Amplifier Output |
| 4 | 8 | V_{CC} | Positive Supply. Bypass V_{CC} to GND with a 0.1 μ F capacitor. |
| 5 | 7 | BIAS | Low-Noise Microphone Bias Output. 2.3V output for MAX9812L/MAX9813L. 4V output for MAX9812H/MAX9813H. |
| 6 | — | IN | Amplifier Input (MAX9812) |
| — | 6 | IN1 | Amplifier Input 1 (MAX9813) |
| — | 5 | IN2 | Amplifier Input 2 (MAX9813) |
| — | 4 | IN1/ $\overline{\text{IN2}}$ | Input Selector. When IN1/ $\overline{\text{IN2}}$ is high, IN1 is selected. When IN1/ $\overline{\text{IN2}}$ low, IN2 is selected. |

Detailed Description

The MAX9812_/MAX9813_ are low-power fixed-gain microphone amplifiers available in a single- or dual-input configuration. The gain is set at 10V/V (20dB) with a 400kHz, -3dB bandwidth. They also feature a low-noise, integrated microphone input bias voltage.

Single/Dual Input

The MAX9812L/MAX9812H are single-input amplifiers and the MAX9813L/MAX9813H are dual-input amplifiers. All devices typically have an input impedance of 85k Ω . The inputs to the dual version are controlled through a fast 2:1 mux, selectable through the IN1/ $\overline{\text{IN2}}$ pin. Driving IN1/ $\overline{\text{IN2}}$ high selects IN1 and driving the IN1/ $\overline{\text{IN2}}$ low selects IN2. IN1/ $\overline{\text{IN2}}$ is designed to be driven by a logic high of $\geq 2V$ and a logic low $\leq 0.8V$. The IN1/ $\overline{\text{IN2}}$ has a 10 μ s switching time from one channel to the other.

PC2001 Low-Noise Microphone BIAS

The MAX9812_/MAX9813_ provide a low-noise voltage BIAS designed for biasing electret condenser microphone (ECM) cartridges. The BIAS output is regulated to typically 2.3V for the MAX9812L/MAX9813L and 4V for the MAX9812H/MAX9813H. In the single-input version (MAX9812_), the BIAS output can source up to 1mA. In the dual-input version (MAX9813_), the BIAS output can source up to 2mA. The MAX9812H/MAX9813H provides a PC2001-compliant BIAS voltage.

Output Stage

The MAX9812_/MAX9813_ rail-to-rail output (OUT) typically swings to within 100mV of the rails when driving 10k Ω .

The output DC bias point is set to 1.5V for the MAX9812L/MAX9813L and 2.5V for the MAX9812H/MAX9813H.

Shutdown Mode

$\overline{\text{SHDN}}$ controls whether the MAX9812_/MAX9813_ is active or in shutdown mode. Driving $\overline{\text{SHDN}}$ low forces a low-power (100nA) shutdown mode. In this mode, the OUT pin is set to a high-impedance state and the BIAS pin is pulled down (70k Ω). Driving $\overline{\text{SHDN}}$ high enables the MAX9812_/MAX9813_. $\overline{\text{SHDN}}$ is a high-impedance input and cannot be left unconnected.

Driving Capacitive Loads

The MAX9812_/MAX9813_ output can drive up to 50pF of capacitance without sustained oscillations.

Thermal Shutdown

The thermal shutdown feature protects the MAX9812_/MAX9813_ from destruction due to overheating caused by shorting the outputs. This protection feature causes OUT and BIAS to shut down and go high impedance when the die temperature reaches +140°C. The device restarts after the die temperature falls below +120°C.

Applications Information

Power-Up

The MAX9812_/MAX9813_ output typically settles to 95% within 10ms after power-up.

Typical Application Circuit

Figure 1 shows the MAX9813H used as a preamplifier with the MAX9760 3W audio power amplifier.

MAX9812/MAX9813

Tiny, Low-Cost, Single/Dual-Input, Fixed-Gain Microphone Amplifiers with Integrated Bias

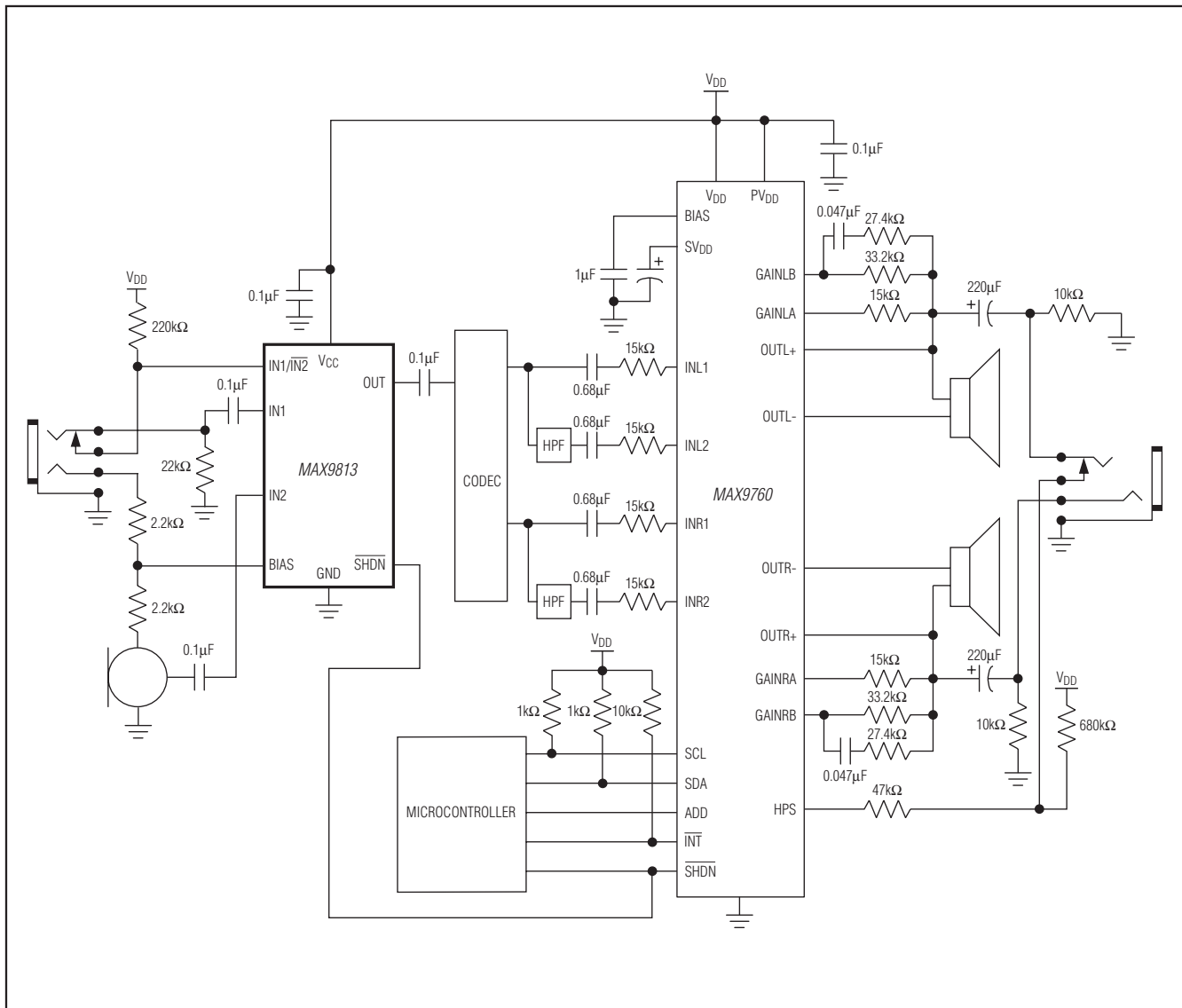
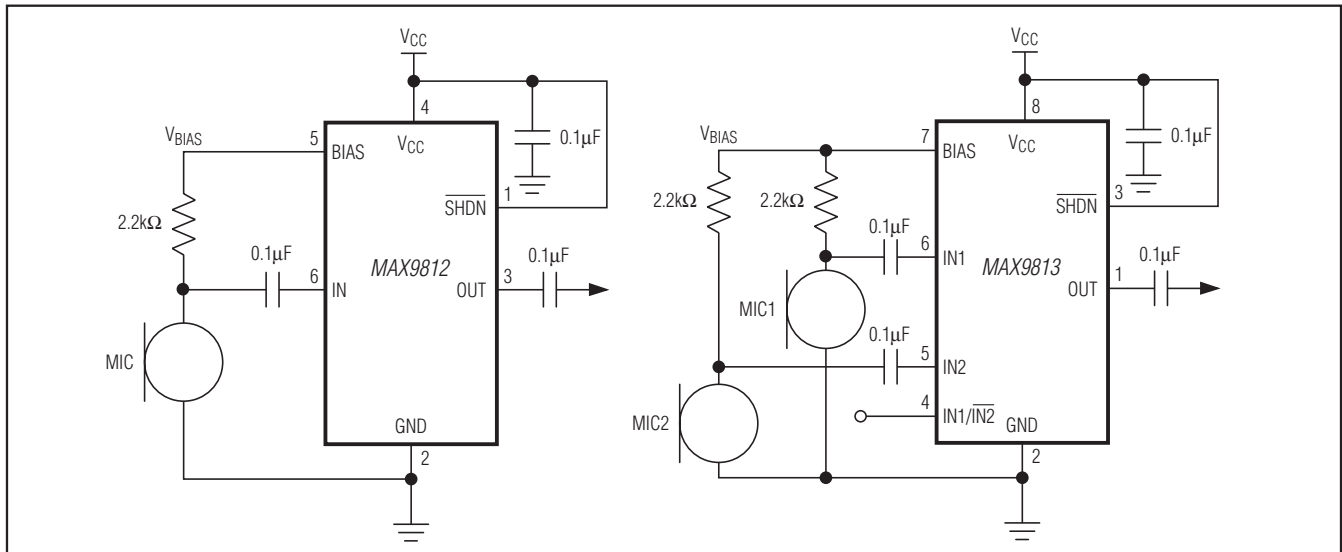

Figure 1. Typical Application Circuit

MAX9812/MAX9813

Tiny, Low-Cost, Single/Dual-Input, Fixed-Gain Microphone Amplifiers with Integrated Bias

Typical Operating Circuits



Pin Configurations

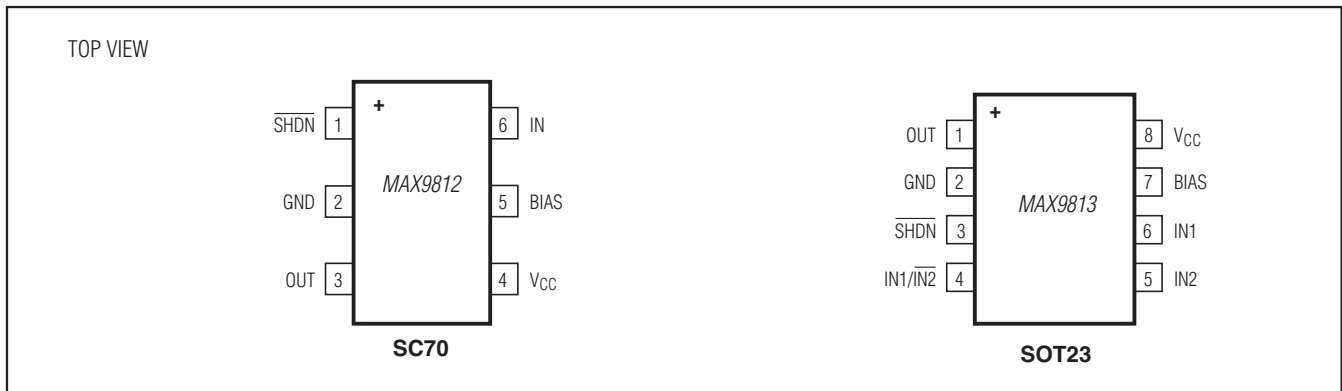

Selector Guide

| PART | PIN-PACKAGE | V _{CC} (V) | TOP MARK |
|---------------|-------------|---------------------|----------|
| MAX9812LEXT+T | 6 SC70 | 2.7 to 3.6 | ABJ |
| MAX9812HEXT+T | 6 SC70 | 4.5 to 5.5 | ABK |
| MAX9813LEKA+T | 8 SOT23 | 2.7 to 3.6 | AEEU |
| MAX9813HEKA+T | 8 SOT23 | 4.5 to 5.5 | AEEV |

+Denotes a lead(Pb)-free/RoHS-compliant package.

Package Information

For the latest package outline information and land patterns (footprints), go to www.maximintegrated.com/packages. Note that a "+", "#", or "-" in the package code indicates RoHS status only. Package drawings may show a different suffix character, but the drawing pertains to the package regardless of RoHS status.

| PACKAGE TYPE | PACKAGE CODE | OUTLINE NO. | LAND PATTERN NO. |
|--------------|--------------|-------------------------|-------------------------|
| 6 SC70 | X6SN+1 | 21-0077 | 90-0189 |
| 8 SOT | K8+1 | 21-0078 | 90-0176 |

Chip Information

PROCESS: BICMOS

MAX9812/MAX9813

Tiny, Low-Cost, Single/Dual-Input, Fixed-Gain Microphone Amplifiers with Integrated Bias

Revision History

| REVISION NUMBER | REVISION DATE | DESCRIPTION | PAGES CHANGED |
|-----------------|---------------|--|---------------|
| 0 | 4/03 | Initial release | — |
| 1 | 8/12 | Added lead-free description | 1, 9 |
| 2 | 9/12 | Added automotive qualified part | 1 |
| 3 | 4/14 | Removed automotive qualified part and references | 1 |



Maxim cannot assume responsibility for use of any circuitry other than circuitry entirely embodied in a Maxim product. No circuit patent licenses are implied. Maxim reserves the right to change the circuitry and specifications without notice at any time. The parametric values (min and max limits) shown in the Electrical Characteristics table are guaranteed. Other parametric values quoted in this data sheet are provided for guidance.

Looking for pricing, stock, or lifecycle information?

Click below to explore more details on WIN SOURCE:

- ⊖ [View MAX9812HEXT+T on WIN SOURCE](#)
- ⊖ [Maxim Integrated Information](#)

Optimize Your Supply Chain with WIN SOURCE Solutions

- ✓ Global Sourcing Solution
- ✓ Obsolete Management
- ✓ Cost Control Management
- ✓ Shortage Management
- ✓ Alternative Solution
- ✓ Excess Inventory Management