



**THE DATASHEET OF
MAX98088EWY+T**



MAX98088

Stereo Audio Codec with FlexSound Technology

General Description

The MAX98088 is a full-featured audio codec whose high performance and low power consumption make it ideal for portable applications.

Class D speaker amplifiers provide efficient amplification for two speakers. Low radiated emissions enable completely filterless operation. Integrated bypass switches optionally connect an external amplifier to the transducer when the Class D amplifiers are disabled.

The IC features a stereo Class H headphone amplifier that utilizes a dual-mode charge pump to maximize efficiency while outputting a ground referenced signal that does not require output coupling capacitors.

The IC also features a mono differential amplifier that can also be configured as a stereo line output.

Two differential analog microphone inputs are available as well as support for two PDM digital microphones. Integrated switches allow for an additional microphone input as well as microphone signals to be routed out to external devices. Two flexible single-ended or differential line inputs may be connected to an FM radio or other sources.

Integrated FlexSound™ technology improves loudspeaker performance by optimizing the signal level and frequency response while limiting the maximum distortion and power at the output to prevent speaker damage. Automatic gain control (AGC) and a noise gate optimize the signal level of microphone input signals to make best use of the ADC dynamic range.

The device is fully specified over the -40°C to +85°C extended temperature range.

FlexSound is a trademark of Maxim Integrated Products, Inc.

Features

- ◆ 5.6mW Power Consumption (DAC to HP at 97dB DR)
- ◆ 101dB DR Stereo DAC (8kHz < f_S < 96kHz)
- ◆ 93dB DR Stereo ADC (8kHz < f_S < 96kHz)
- ◆ Stereo Low EMI Class D Amplifiers
950mW/Channel (8Ω, V_{SPKVDD_} = 4.2V)
- ◆ Efficient Class H Headphone Amplifier
- ◆ Differential Receiver Amplifier/Stereo Line Outputs
- ◆ 2 Stereo Single-Ended/Mono Differential Line Inputs
- ◆ 3 Differential Microphone Inputs
- ◆ FlexSound Technology
 - 5-Band Parametric EQ
 - Automatic Level Control (ALC)
 - Excursion Limiter
 - Speaker Power Limiter
 - Speaker Distortion Limiter
 - Microphone Automatic Gain Control and Noise Gate
- ◆ Dual I²S/PCM/TDM Digital Audio Interfaces
- ◆ Asynchronous Digital Mixing
- ◆ Supports Master Clock Frequencies from 10MHz to 60MHz
- ◆ RF Immune Analog Inputs and Outputs
- ◆ Extensive Click-and-Pop Reduction Circuitry
- ◆ Available in 63-Bump WLP Package (3.80mm x 3.30mm, 0.4mm Pitch)

Ordering Information appears at end of data sheet.

For related parts and recommended products to use with this part, refer to www.maxim-ic.com/MAX98088.related.

Simplified Block Diagram

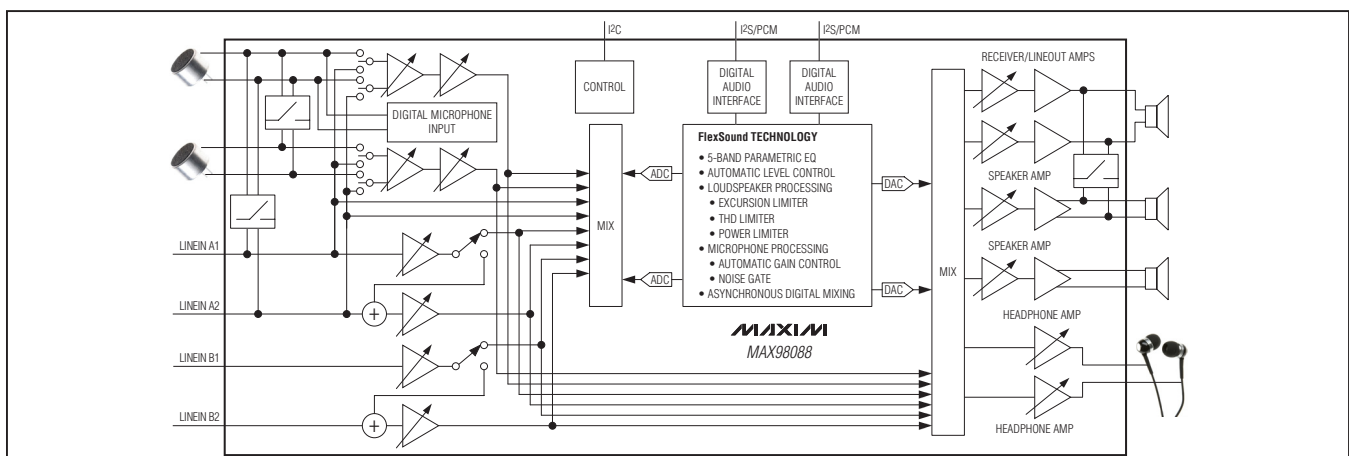

MAX98088

Stereo Audio Codec with FlexSound Technology

TABLE OF CONTENTS

General Description	1
Features	1
Simplified Block Diagram	1
Functional Diagram	5
Absolute Maximum Ratings	6
Electrical Characteristics	6
Digital Input/Output Characteristics	19
Input Clock Characteristics	21
Audio Interface Timing Characteristics	22
Digital Microphone Timing Characteristics	23
I ² C Timing Characteristics	24
Power Consumption	25
Typical Operating Characteristics	28
Microphone to ADC	28
Line to ADC	32
Line-In Pin Direct to ADC	33
Digital Loopback	33
Analog Loopback	34
DAC to Receiver	35
Line to Receiver	37
DAC to Line Output	38
Line to Line Output	38
DAC to Speaker	39
Line to Speaker	43
DAC to Headphone	44
Line to Headphone	51
Speaker Bypass Switch	52
Pin Configuration	53
Pin Description	54
Detailed Description	56
I ² C Slave Address	57
Registers	57
Power Management	63
Microphone Inputs	65
Line Inputs	67
ADC Input Mixers	68

**Stereo Audio Codec
with FlexSound Technology****TABLE OF CONTENTS (continued)**

Record Path Signal Processing	69
Microphone AGC	69
Noise Gate	69
ADC Record Level Control	72
Sidetone	73
Digital Audio Interfaces	74
Clock Control	81
Sample Rate Converter	84
Passband Filtering	85
Playback Path Signal Processing	88
Automatic Level Control	88
Parametric Equalizer	89
Playback Level Control	91
DAC Input Mixers	92
Receiver Amplifier	93
Receiver Output Mixer	94
Receiver Output Volume	95
Speaker Amplifiers	96
Speaker Output Mixers	97
Speaker Amplifier Signal Processing	98
Excursion Limiter	98
Speaker Output Volume	98
Power Limiter	101
Distortion Limiter	102
Headphone	103
DirectDrive Headphone Amplifier	103
Charge Pump	103
Class H Operation	104
Headphone Output Mixers	105
Headphone Output Volume	106
Output Bypass Switches	107
Click-and-Pop Reduction	108
Jack Detection	109
Jack Detection and Removal	109
Battery Measurement	110
Device Status	111

MAX98088

Stereo Audio Codec with FlexSound Technology

TABLE OF CONTENTS (CONTINUED)

I ² C Serial Interface	112
Bit Transfer	112
START and STOP Conditions	112
Early STOP Conditions	112
Device Revision	112
Slave Address	113
Acknowledge	113
Write Data Format	113
Read Data Format	114
Applications Information	115
Typical Operating Circuits	115
Filterless Class D Operation	117
RF Susceptibility	117
Startup/Shutdown Sequencing	117
Component Selection	118
Optional Ferrite Bead Filter	118
Input Capacitor	118
Charge-Pump Capacitor Selection	118
Charge-Pump Flying Capacitor	119
Charge-Pump Holding Capacitor	119
Unused Pins	119
Recommended PCB Routing	120
Supply Bypassing, Layout, and Grounding	120
WLP Applications Information	121
Ordering Information	121
Package Information	122
Revision History	123

Stereo Audio Codec with FlexSound Technology

ABSOLUTE MAXIMUM RATINGS

(Voltages with respect to AGND.)

DVDD, AVDD, PVDD, HPVDD.....	-0.3V to +2.2V
SPKLVDD, SPKRVDD, DVDDS1, DVDDS2.....	-0.3V to +6.0V
DGND, HPGND, SPKLGND, SPKRGND.....	-0.1V to +0.1V
HPVSS.....	(HPGND - 2.2V) to (HPGND + 0.3V)
C1N.....	(HPVSS - 0.3V) to (HPGND + 0.3V)
C1P.....	(HPGND - 0.3V) to (HPVDD + 0.3V)
REF, MICBIAS.....	-0.3V to (SPKLVDD + 0.3V)
MCLK, SDINS1, SDINS2, JACKSNS, SDA, SCL, I ² C.....	-0.3V to +6.0V
LRCLKS1, BCLKS1, SDOUTS1.....	-0.3V to (DVDDS1 + 0.3V)
LRCLKS2, BCLKS2, SDOUTS2.....	-0.3V to (DVDDS2 + 0.3V)

REG, INA1/EXTMICP, INA2/EXTMICN, INB1, INB2, MIC1P/DIGMICDATA, MIC1N/DIGMICCLK, MIC2P, MIC2N.....	-0.3V to +2.2V
HPSNS.....	(HPGND - 0.3V) to (HPGND + 0.3V)
HPL, HPR.....	(HPVSS - 0.3V) to (HPVDD + 0.3V)
RECP/LOUTL/RXINP, REC�/LOUTR/ RXINN.....	(SPKLGND - 0.3V) to (SPKLVDD + 0.3V)
SPKLP, SPKLN.....	(SPKLGND - 0.3V) to (SPKLVDD + 0.3V)
SPKRP, SPKRN.....	(SPKRGND - 0.3V) to (SPKRVDD + 0.3V)
Continuous Power Dissipation (T _A = +70°C)	
63-Bump WLP (derate 25.6mW/°C above +70°C).....	2.05W
Operating Temperature Range.....	-40°C to +85°C
Storage Temperature Range.....	-65°C to +150°C
Soldering Temperature (reflow).....	+260°C

Stresses beyond those listed under "Absolute Maximum Ratings" may cause permanent damage to the device. These are stress ratings only, and functional operation of the device at these or any other conditions beyond those indicated in the operational sections of the specifications is not implied. Exposure to absolute maximum rating conditions for extended periods may affect device reliability.

ELECTRICAL CHARACTERISTICS

(V_{AVDD} = V_{PVDD} = V_{DVDD} = V_{DVDDS1} = V_{DVDDS2} = +1.8V, V_{SPKLVDD} = V_{SPKRVDD} = 3.7V. Speaker loads (Z_{SPK}) connected between SPK_P and SPK_N. Receiver load (R_{REC}) connected between RECP and REC�. Headphone loads (R_{HP}) connected from HPL or HPR to HPGND. Line out loads (R_{LOAD}) connected from LOUTL or LOUTR to SPKLGND. R_{LOAD} = R_{HP} = ∞, R_{REC} = ∞, Z_{SPK} = ∞, C_{REF} = 2.2μF, C_{MICBIAS} = C_{REG} = 1μF, C_{C1N-C1P} = 1μF, C_{HPVDD} = C_{HPVSS} = 1μF. AV_{MICPRE} = +20dB, AV_{MICPGA} = 0dB, AV_{DACATTN} = 0dB, AV_{DACGAIN} = 0dB, AV_{ADCLVL} = 0dB, AV_{ADCGAIN} = 0dB, AV_{PGAIN} = 0dB, AV_{HP} = 0dB, AV_{REC} = 0dB, AV_{SPK} = 0dB, MCLK = 12.288MHz, LRCLK = 48kHz, MAS = 1. T_A = T_{MIN} to T_{MAX}, unless otherwise noted. Typical values are at +25°C.) (Note 1)

PARAMETER	SYMBOL	CONDITIONS	MIN	TYP	MAX	UNITS	
POWER SUPPLY							
Supply Voltage Range		Guaranteed by PSRR	V _{SPKLVDD} , V _{SPKRVDD}	2.8		5.5	V
			V _{DVDD} , V _{AVDD} , V _{PVDD}	1.65	1.8	2	
			V _{DVDDS1} , V _{DVDDS2}	1.65		3.6	
Total Supply Current (Notes 2 and 3)	I _{VDD}	Full-duplex 8kHz mono, receiver output, MAS = 1	Analog		4.5	8	mA
			Speaker		1.6	2.3	
			Digital		1.3	2	
		DAC playback 48kHz stereo, headphone outputs, MAS = 1	Analog		1.9	3	
			Speaker		0.001	0.0058	
			Digital		2.47	3.5	
		DAC playback 48kHz stereo, speaker outputs, MAS = 1	Analog		3.6	6.5	
			Speaker		6.41	8.5	
			Digital		2.49	3.5	
Shutdown Supply Current (Note 2)		T _A = +25°C	Analog		0.2	2	μA
			Speaker		0.01	1	
			Digital		1	5	
REF Voltage				2.5		V	
REG Voltage				0.79		V	
Shutdown to Full Operation		V _{SEN} = 0		30		ms	
		V _{SEN} = 1		17			

Stereo Audio Codec with FlexSound Technology

ELECTRICAL CHARACTERISTICS (continued)

(V_{AVDD} = V_{PVDD} = V_{DVDD} = V_{DVDDS1} = V_{DVDDS2} = +1.8V, V_{SPKLVDD} = V_{SPKRVDD} = 3.7V. Speaker loads (Z_{SPK}) connected between SPK_P and SPK_N. Receiver load (R_{REC}) connected between RECP and REC_N. Headphone loads (R_{HP}) connected from HPL or HPR to HPGND. Line out loads (R_{LOAD}) connected from LOU_{TL} or LOU_{TR} to SPK_{LGND}. R_{LOAD} = R_{HP} = ∞, R_{REC} = ∞, Z_{SPK} = ∞, C_{REF} = 2.2μF, C_{MICBIAS} = C_{REG} = 1μF, C_{C1N-C1P} = 1μF, C_{HPVDD} = C_{HPVSS} = 1μF. AV_{MICPRE_} = +20dB, AV_{MICPGA_} = 0dB, AV_{DACATTN} = 0dB, AV_{DACGAIN} = 0dB, AV_{ADCLVL} = 0dB, AV_{ADCGAIN} = 0dB, AV_{PGAIN_} = 0dB, AV_{HP_} = 0dB, AV_{REC} = 0dB, AV_{SPK_} = 0dB, MCLK = 12.288MHz, LRCLK = 48kHz, MAS = 1. T_A = T_{MIN} to T_{MAX}, unless otherwise noted. Typical values are at +25°C.) (Note 1)

PARAMETER	SYMBOL	CONDITIONS		MIN	TYP	MAX	UNITS	
MICROPHONE TO ADC PATH								
Dynamic Range	DR	f _S = 8kHz, MODE = 0 (IIR voice), AV _{MICPRE_} = 0dB (Note 4)			88		dB	
Total Harmonic Distortion + Noise	THD+N	V _{IN} = 0.1V _{P-P} , f _S = 8kHz, f = 1kHz			-78		dB	
		AV _{MICPRE_} = 0dB, V _{IN} = 1V _{P-P} , f = 1kHz			-85			
		AV _{MICPRE_} = +30dB, V _{IN} = 32mV _{P-P} , f = 1kHz			-71			
Common-Mode Rejection Ratio	CMRR	V _{IN} = 100mV _{P-P} , f = 217Hz			74		dB	
Power-Supply Rejection Ratio	PSRR	V _{AVDD} = 1.65V to 1.95V, input referred, MIC inputs floating		50	62		dB	
		f = 217Hz, V _{RIPPLE} = 200mV _{P-P} , input referred			62			
		f = 1kHz, V _{RIPPLE} = 200mV _{P-P} , input referred			62			
		f = 10kHz, V _{RIPPLE} = 200mV _{P-P} , input referred			53			
Path Phase Delay		1kHz, 0dB input, highpass filter disabled measured from analog input to digital output	MODE = 0 (IIR voice) 8kHz		2.2		ms	
			MODE = 0 (IIR voice) 16kHz		1.1			
			MODE = 1 (FIR audio) 8kHz		4.5			
			MODE = 1 (FIR audio) 48kHz		0.76			
MICROPHONE PREAMP								
Full-Scale Input		AV _{MICPRE_} = 0dB			1.05		V _{P-P}	
Preamplifier Gain	AV _{MICPRE_}	(Note 5)	PA1EN/PA2EN = 01		0		dB	
			PA1EN/PA2EN = 10		19.5	20		20.5
			PA1EN/PA2EN = 11		29.5	30		30.5
PGA Gain	AV _{MICPGA_}	(Note 5)	PGAM1/PGAM2 = 0x00		19	20	21	dB
			PGAM1/PGAM2 = 0x14		0			
MIC Input Resistance	R _{IN_MIC}	All gain settings, measured at MIC1P/ MIC1N/MIC2P/MIC2N			50		kΩ	

Stereo Audio Codec with FlexSound Technology

ELECTRICAL CHARACTERISTICS (continued)

(VAVDD = VPVDD = VD VDD = VD VDD S1 = VD VDD S2 = +1.8V, VSPKLVDD = VSPKRVDD = 3.7V. Speaker loads (ZSPK) connected between SPK_P and SPK_N. Receiver load (RREC) connected between RECP and REC N. Headphone loads (RH P) connected from HPL or HPR to HPGND. Line out loads (RLOAD) connected from LOU TL or LOU TR to SPKLGND. RLOAD = RH P = ∞, RREC = ∞, ZSPK = ∞, CREF = 2.2μF, CMICBIAS = CREG = 1μF, CC1N-C1P = 1μF, CHPVDD = CHPVSS = 1μF. AVMICPRE_ = +20dB, AVMICPGA_ = 0dB, AVDACATTN = 0dB, AVDACGAIN = 0dB, AVADCLVL = 0dB, AVADCGAIN = 0dB, AVPGAIN_ = 0dB, AVHP_ = 0dB, AVREC = 0dB, AVSPK_ = 0dB, MCLK = 12.288MHz, LRCLK = 48kHz, MAS = 1. TA = TMIN to TMAX, unless otherwise noted. Typical values are at +25°C.) (Note 1)

PARAMETER	SYMBOL	CONDITIONS	MIN	TYP	MAX	UNITS
MICROPHONE BIAS						
MICBIAS Output Voltage	VMICBIAS	ILOAD = 1mA	2.15	2.2	2.25	V
Load Regulation		ILOAD = 1mA to 2mA		0.5	4.5	mV
Line Regulation		VSPKLVDD = 2.8V to 5.5V		110		μV
Ripple Rejection		f = 217Hz, VRIPPLE (SPKLVDD) = 100mVp-p		92		dB
		f = 10kHz, VRIPPLE (SPKLVDD) = 100mVp-p		83		
Noise Voltage		A-weighted, f = 20Hz to 20kHz		3.9		μVRMS
		P-weighted, f = 20Hz to 4kHz		2.1		
		f = 1kHz		50		
MICROPHONE BYPASS SWITCH						
On-Resistance	RON	IMIC1_ = 100mA, INABYP = MIC2BYP = 1, VMIC2_ = VINA_ = 0V, AVDD, TA = +25°C		5	30	Ω
Total Harmonic Distortion + Noise	THD+N	VIN = 2Vp-p, VCM = 0.9V, RL = 10kΩ, f = 1kHz, INABYP = MIC2BYP = 1		-80		dB
Off-Isolation		VIN = 2Vp-p, VCM = 0.9V, RL = 10kΩ, f = 1kHz		60		dB
Off-Leakage Current		VMIC1_ = [0V, AVDD], VMIC2_/VINA_ = [AVDD, 0V]	-1		+1	μA
LINE INPUT TO ADC PATH						
Dynamic Range (Note 4)	DR	INA pin direct, fS = 48kHz, MODE = 1 (FIR audio)		93		dB
Total Harmonic Distortion + Noise	THD+N	VIN = 1Vp-p, f = 1kHz		-82	-74	dB
Gain Error		DC accuracy		1		%
Power-Supply Rejection Ratio	PSRR	VAVDD = 1.65V to 1.95V, input referred, line inputs floating, TA = +25°C	57	68		dB
		f = 217Hz, VRIPPLE = 200mVp-p, AVADC = 0dB, input referred		63		
		f = 1kHz, VRIPPLE = 200mVp-p, AVADC = 0dB, input referred		63		
		f = 10kHz, VRIPPLE = 200mVp-p, AVADC = 0dB, input referred		57		

Stereo Audio Codec with FlexSound Technology

ELECTRICAL CHARACTERISTICS (continued)

(VAVDD = VPVDD = VD VDD = VD VDD S1 = VD VDD S2 = +1.8V, VSPKLVDD = VSPKRVDD = 3.7V. Speaker loads (ZSPK) connected between SPK_P and SPK_N. Receiver load (RREC) connected between RECP and REC N. Headphone loads (RHP) connected from HPL or HPR to HPGND. Line out loads (RLOAD) connected from LOU TL or LOU TR to SPK LGND. RLOAD = RHP = ∞, RREC = ∞, ZSPK = ∞, CREF = 2.2μF, CMICBIAS = CREG = 1μF, CC1N-C1P = 1μF, CHPVDD = CHPVSS = 1μF. AVMICPRE_ = +20dB, AVMICPGA_ = 0dB, AVDACATTN = 0dB, AVDACGAIN = 0dB, AVADCLVL = 0dB, AVADCGAIN = 0dB, AVPGAIN_ = 0dB, AVHP_ = 0dB, AVREC = 0dB, AVSPK_ = 0dB, MCLK = 12.288MHz, LRCLK = 48kHz, MAS = 1. TA = TMIN to TMAX, unless otherwise noted. Typical values are at +25°C.) (Note 1)

PARAMETER	SYMBOL	CONDITIONS		MIN	TYP	MAX	UNITS
LINE INPUT PREAMP							
Full-Scale Input	VIN	AVPGAIN_ = 0dB		1			VP-P
		AVPGAIN_ = -6dB		1.4			
Level Adjust Gain	AVPGAIN_	TA = +25°C (Note 5)	PGAINA/PGAINB = 0x0	19	20	21	dB
			PGAINA/PGAINB = 0x1	13	14	15	
			PGAINA/PGAINB = 0x2	2	3	4	
			PGAINA/PGAINB = 0x3	0			
			PGAINA/PGAINB = 0x4	-4	-3	-2	
			PGAINA/PGAINB = 0x5, 0x6, 0x7	-7	-6	-5	
Input Resistance	RIN	AVPGAIN_ = +20dB		14.5	21	28	kΩ
		AVPGAIN_ = +14dB		20			
		AVPGAIN_ = +3dB		20			
		AVPGAIN_ = 0dB		7.5	10	14	
		AVPGAIN_ = -3dB		20			
		AVPGAIN_ = -6dB		20			
Feedback Resistance	RIN_FB	INAEXT/IINBEXT = 1	TA = +25°C	18	20	22	kΩ
			TA = TMIN to TMAX	16			
ADC LEVEL CONTROL							
ADC Level Adjust Range	AVADCLVL	AVL/AVR = 0xF to 0x0 (Note 5)		-12		+3	dB
ADC Level Step Size					1		dB
ADC Gain Adjust Range	AVADCGAIN	AVLG/AVRG = 00 to 11 (Note 5)		0		18	dB
ADC Gain Adjust Step Size					6		dB
ADC DIGITAL FILTERS							
VOICE MODE IIR LOWPASS FILTER (MODE1 = 0)							
Passband Cutoff	fPLP	Ripple limit cutoff		0.441 x fs			Hz
		-3dB cutoff		0.449 x fs			
Passband Ripple		f < fPLP		-0.1		+0.1	dB
Stopband Cutoff	fSLP					0.47 x fs	Hz
Stopband Attenuation (Note 6)		f > fSLP		74			dB

Stereo Audio Codec with FlexSound Technology

ELECTRICAL CHARACTERISTICS (continued)

(VAVDD = VPVDD = VD VDD = VD VDD S1 = VD VDD S2 = +1.8V, VSPKLVDD = VSPKRVDD = 3.7V. Speaker loads (ZSPK) connected between SPK_P and SPK_N. Receiver load (RREC) connected between RECP and REC_N. Headphone loads (RH P) connected from HPL or HPR to HPGND. Line out loads (RLOAD) connected from LOU_TL or LOU_TR to SPKLGND. RLOAD = RH P = ∞, RREC = ∞, ZSPK = ∞, CREF = 2.2μF, CMICBIAS = CREG = 1μF, CC1N-C1P = 1μF, CHPVDD = CHPVSS = 1μF. AVMICPRE_ = +20dB, AVMICPGA_ = 0dB, AVDACATTN = 0dB, AVDACGAIN = 0dB, AVADCLVL = 0dB, AVADCGAIN = 0dB, AVPGAIN_ = 0dB, AVHP_ = 0dB, AVREC = 0dB, AVSPK_ = 0dB, MCLK = 12.288MHz, LRCLK = 48kHz, MAS = 1. TA = TMIN to TMAX, unless otherwise noted. Typical values are at +25°C.) (Note 1)

PARAMETER	SYMBOL	CONDITIONS	MIN	TYP	MAX	UNITS
VOICE MODE IIR HIGHPASS FILTER (MODE1 = 0)						
Passband Cutoff (-3dB from Peak)	f _{AHPPB}	AVFLT = 0x1 (Elliptical tuned for f _S = 16kHz + 217Hz notch)			0.0161 x f _S	Hz
		AVFLT = 0x2 (500Hz Butterworth tuned for f _S = 16kHz)			0.0319 x f _S	
		AVFLT = 0x3 (Elliptical tuned for f _S = 8kHz + 217Hz notch)			0.0321 x f _S	
		AVFLT = 0x4 (500Hz Butterworth tuned for f _S = 8kHz)			0.0632 x f _S	
		AVFLT = 0x5 (f _S /240 Butterworth)			0.0043 x f _S	
Stopband Cutoff (-30dB from Peak)	f _{AHPSB}	AVFLT = 0x1 (Elliptical tuned for f _S = 16kHz + 217Hz notch)	0.0139 x f _S			Hz
		AVFLT = 0x2 (500Hz Butterworth tuned for f _S = 16kHz)	0.0156 x f _S			
		AVFLT = 0x3 (Elliptical tuned for f _S = 8kHz + 217Hz notch)	0.0279 x f _S			
		AVFLT = 0x4 (500Hz Butterworth tuned for f _S = 8kHz)	0.0312 x f _S			
		AVFLT = 0x5 (f _S /240 Butterworth)	0.0018 x f _S			
DC Attenuation	DCATTEN	AVFLT ≠ 000		90		dB
STEREO AUDIO MODE FIR LOWPASS FILTER (MODE1 = 1, DHF1 = 0, LRCLK < 50kHz)						
Passband Cutoff	f _{PLP}	Ripple limit cutoff	0.43 x f _S			Hz
		-3dB cutoff	0.48 x f _S			
		-6.02dB cutoff	0.5 x f _S			
Passband Ripple		f < f _{PLP}	-0.1	+0.1		dB
Stopband Cutoff	f _{SLP}			0.58 x f _S		Hz
Stopband Attenuation (Note 6)		f < f _{SLP}	60			dB
ADC STEREO AUDIO MODE FIR LOWPASS FILTER (MODE1 = 1, DHF1 = 1, LRCLK > 50kHz)						
Passband Cutoff	f _{PLP}	Ripple limit cutoff	0.208 x f _S			Hz
		-3dB cutoff	0.28 x f _S			
Passband Ripple		f < f _{PLP}	-0.1	+0.1		dB
Stopband Cutoff	f _{SLP}			0.417 x f _S		Hz
Stopband Attenuation		f < f _{SLP}	60			dB

Stereo Audio Codec with FlexSound Technology

ELECTRICAL CHARACTERISTICS (continued)

(VAVDD = VPVDD = VD VDD = VD VDD S1 = VD VDD S2 = +1.8V, VSPKLVDD = VSPKRVDD = 3.7V. Speaker loads (ZSPK) connected between SPK_P and SPK_N. Receiver load (RREC) connected between RECP and REC N. Headphone loads (RHP) connected from HPL or HPR to HPGND. Line out loads (RLOAD) connected from LOU TL or LOU TR to SPKLGND. RLOAD = RHP = ∞, RREC = ∞, ZSPK = ∞, CREF = 2.2μF, CMICBIAS = CREG = 1μF, CC1N-C1P = 1μF, CHPVDD = CHPVSS = 1μF. AVMICPRE_ = +20dB, AVMICPGA_ = 0dB, AVDACATTN = 0dB, AVDACGAIN = 0dB, AVADCLVL = 0dB, AVADCGAIN = 0dB, AVPGAIN_ = 0dB, AVHP_ = 0dB, AVREC = 0dB, AVSPK_ = 0dB, MCLK = 12.288MHz, LRCLK = 48kHz, MAS = 1. TA = TMIN to TMAX, unless otherwise noted. Typical values are at +25°C.) (Note 1)

PARAMETER	SYMBOL	CONDITIONS	MIN	TYP	MAX	UNITS
ADC STEREO AUDIO MODE DC BLOCKING HIGHPASS FILTER (MODE1 = 1)						
Passband Cutoff (-3dB from Peak)	fAHPPB	AVFLT ≠ 000		0.000125 x fs		Hz
DC Attenuation	DCAtten	AVFLT ≠ 000		90		dB
MICROPHONE AUTOMATIC GAIN CONTROL						
AGC Hold Duration		AGCHLD = 01		50		ms
		AGCHLD = 11		400		
AGC Attack Time		AGCATK = 00		2		ms
		AGCATK = 11		123		
AGC Release Time		AGCRLS = 000		0.078		s
		AGCRLS = 111		10		
AGC Threshold Level		AGCTH = 0x0 to 0xF	-3		+18	dB
AGC Threshold Step Size				1		dB
AGC Gain		(Note 5)	0		20	dB
ADC NOISE GATE						
NG Threshold Level		ANTH = 0x3 to 0xF, referred to 0dBFS	-64		-16	dB
NG Attenuation		(Note 5)	0		12	dB
ADC-TO-DAC DIGITAL SIDETONE (MODE = 0)						
Sidetone Gain Adjust Range	AVSTGA	DVST = 0x01		-0.5		dB
		DVST = 0x1F		-60.5		
Sidetone Gain Adjust Step Size				2		dB
Sidetone Path Phase Delay		1kHz, 0dB input, highpass filter disabled	8kHz		2.2	ms
			16kHz		1.1	
ADC-TO-DAC DIGITAL LOOP-THROUGH PATH						
Dynamic Range (Note 4)	DR	fs = 48kHz, MCLK = 12.288MHz, MODE = 1 (FIR audio), MIC to HP output, TA = +25°C	83	93		dB
Total Harmonic Distortion + Noise	THD+N	f = 1kHz, fs = 48kHz, MCLK = 12.288MHz, MODE = 1 (FIR audio), MIC to HP output		81		dB
DAC LEVEL CONTROL						
DAC Attenuation Range	AVDACATTN	DV_ = 0xF to 0x0 (Note 5)	-15		0	dB
DAC Attenuation Step Size				1		dB
DAC Gain Adjust Range	AVDACGAIN	DV1G = 00 to 11 (Note 5)	0		18	dB
DAC Gain Adjust Step Size				6		dB

Stereo Audio Codec with FlexSound Technology

ELECTRICAL CHARACTERISTICS (continued)

(VAVDD = VPVDD = VD VDD = VD VDD S1 = VD VDD S2 = +1.8V, VSPKLVDD = VSPKRVDD = 3.7V. Speaker loads (ZSPK) connected between SPK_P and SPK_N. Receiver load (RREC) connected between RECP and REC N. Headphone loads (RHP) connected from HPL or HPR to HPGND. Line out loads (RLOAD) connected from LOU TL or LOU TR to SPKLGND. RLOAD = RHP = ∞, RREC = ∞, ZSPK = ∞, CREF = 2.2μF, CMICBIAS = CREG = 1μF, CC1N-C1P = 1μF, CHPVDD = CHPVSS = 1μF. AVMICPRE_ = +20dB, AVMICPGA_ = 0dB, AVDACATTN = 0dB, AVDACGAIN = 0dB, AVADCLVL = 0dB, AVADCGAIN = 0dB, AVPGAIN_ = 0dB, AVHP_ = 0dB, AVREC = 0dB, AVSPK_ = 0dB, MCLK = 12.288MHz, LRCLK = 48kHz, MAS = 1. TA = TMIN to TMAX, unless otherwise noted. Typical values are at +25°C.) (Note 1)

PARAMETER	SYMBOL	CONDITIONS	MIN	TYP	MAX	UNITS
DAC DIGITAL FILTERS						
VOICE MODE IIR LOWPASS FILTER (MODE1 = 0)						
Passband Cutoff	f _{PLP}	Ripple limit cutoff	0.448 x f _s			Hz
		-3dB cutoff	0.451 x f _s			
Passband Ripple		f < f _{PLP}	-0.1		+0.1	dB
Stopband Cutoff	f _{SLP}			0.476 x f _s		Hz
Stopband Attenuation (Note 6)		f > f _{SLP}	75			dB
VOICE MODE IIR HIGHPASS FILTER (MODE1 = 0)						
Passband Cutoff (-3dB from Peak)	f _{DHPPB}	DVFLT = 0x1 (Elliptical tuned for f _s = 16kHz + 217Hz notch)			0.0161 x f _s	Hz
		DVFLT = 0x2 (500Hz Butterworth tuned for f _s = 16kHz)			0.0312 x f _s	
		DVFLT = 0x3 (Elliptical tuned for f _s = 8kHz + 217Hz notch)			0.0321 x f _s	
		DVFLT = 0x4 (500Hz Butterworth tuned for f _s = 8kHz)			0.0625 x f _s	
		DVFLT = 0x5 (f _s /240 Butterworth)			0.0042 x f _s	
Stopband Cutoff (-30dB from Peak)	f _{DHPSB}	DVFLT = 0x1 (Elliptical tuned for f _s = 16kHz + 217Hz notch)	0.0139 x f _s			Hz
		DVFLT = 0x2 (500Hz Butterworth tuned for f _s = 16kHz)	0.0156 x f _s			
		DVFLT = 0x3 (Elliptical tuned for f _s = 8kHz + 217Hz notch)	0.0279 x f _s			
		DVFLT = 0x4 (500Hz Butterworth tuned for f _s = 8kHz)	0.0312 x f _s			
		DVFLT = 0x5 (f _s /240 Butterworth)	0.0021 x f _s			
DC Attenuation	DCATTEN	DVFLT ≠ 000	85			dB
STEREO AUDIO MODE FIR LOWPASS FILTER (MODE1 = 1, DHF1/DHF2 = 0, LRCLK < 50kHz)						
Passband Cutoff	f _{PLP}	Ripple limit cutoff	0.43 x f _s			Hz
		-3dB cutoff	0.47 x f _s			
		-6.02dB cutoff	0.5 x f _s			
Passband Ripple		f < f _{PLP}	-0.1		+0.1	dB
Stopband Cutoff	f _{SLP}			0.58 x f _s		Hz
Stopband Attenuation (Note 6)		f > f _{SLP}	60			dB

Stereo Audio Codec with FlexSound Technology

ELECTRICAL CHARACTERISTICS (continued)

(VAVDD = VPVDD = VD VDD = VD VDD S1 = VD VDD S2 = +1.8V, VSPKLVDD = VSPKRVDD = 3.7V. Speaker loads (ZSPK) connected between SPK_P and SPK_N. Receiver load (RREC) connected between RECP and REC N. Headphone loads (RHP) connected from HPL or HPR to HPGND. Line out loads (RLOAD) connected from LOU TL or LOU TR to SPKLGND. RLOAD = RHP = ∞, RREC = ∞, ZSPK = ∞, CREF = 2.2μF, CMICBIAS = CREG = 1μF, CC1N-C1P = 1μF, CHPVDD = CHPVSS = 1μF. AVMICPRE_ = +20dB, AVMICPGA_ = 0dB, AVDACATTN = 0dB, AVDACGAIN = 0dB, AVADCLVL = 0dB, AVADCGAIN = 0dB, AVPGAIN_ = 0dB, AVHP_ = 0dB, AVREC = 0dB, AVSPK_ = 0dB, MCLK = 12.288MHz, LRCLK = 48kHz, MAS = 1. TA = TMIN to TMAX, unless otherwise noted. Typical values are at +25°C.) (Note 1)

PARAMETER	SYMBOL	CONDITIONS	MIN	TYP	MAX	UNITS
STEREO AUDIO MODE FIR LOWPASS FILTER (MODE1 = 1, DHF1/DHF2 = 1 for LRCLK > 50kHz)						
Passband Cutoff	f _{PLP}	Ripple limit cutoff	0.24 x f _S			Hz
		-3dB cutoff	0.31 x f _S			
Passband Ripple		f < f _{PLP}	-0.1		+0.1	dB
Stopband Cutoff	f _{SLP}				0.477 x f _S	Hz
Stopband Attenuation (Note 6)		f < f _{SLP}	60			dB
STEREO AUDIO MODE DC BLOCKING HIGHPASS FILTER						
Passband Cutoff (-3dB from Peak)	f _{DHPPB}	DVFLT ≠ 000 (DAI1), DCB2 = 1 (DAI2)			0.000104 x f _S	Hz
DC Attenuation	DCATTEN	DVFLT ≠ 000 (DAI1), DCB2 = 1 (DAI2)		90		dB
AUTOMATIC LEVEL CONTROL						
Dual Band Lowpass Corner Frequency		ALCMB = 1		5		kHz
Dual Band Highpass Corner Frequency		ALCMB = 1		5		kHz
Gain Range			0		12	dB
Low-Signal Threshold		ALC TH = 111 to 001	-48		-12	dBFS
Release Time		ALCRLS = 101		0.25		s
		ALCRLS = 000		8		
PARAMETRIC EQUALIZER						
Number of Bands				5		Bands
Per Band Gain Range			-12		+12	dB
Preattenuator Gain Range		(Note 5)	-15		0	dB
Preattenuator Step Size				1		dB
DAC TO RECEIVER AMPLIFIER PATH						
Dynamic Range	DR	f _S = 48kHz, f = 1kHz (Note 4)		96		dB
Total Harmonic Distortion + Noise	THD+N	f = 1kHz, P _{OUT} = 15mW, RREC = 32Ω		-70	-63	dB
Power-Supply Rejection Ratio	PSRR	VSPKLVDD = 2.8V to 5.5V, TA = +25°C	64	75		dB
		f = 217Hz, V _{RIPPLE} = 200mV _{P-P}		-59		
		f = 1kHz, V _{RIPPLE} = 200mV _{P-P}		-59		
		f = 10kHz, V _{RIPPLE} = 200mV _{P-P}		-59		
Click-and-Pop Level	KCP	Peak voltage, A-weighted, 32 samples per second, AVREC = 0dB	Into shutdown		-68	dBV
			Out of shutdown		-72	

Stereo Audio Codec with FlexSound Technology

ELECTRICAL CHARACTERISTICS (continued)

(VAVDD = VPVDD = VD VDD = VD VDD S1 = VD VDD S2 = +1.8V, VSPKLVDD = VSPKRVDD = 3.7V. Speaker loads (Z_{SPK}) connected between SPK_P and SPK_N. Receiver load (R_{REC}) connected between RECP and REC_N. Headphone loads (R_{HP}) connected from HPL or HPR to HPGND. Line out loads (R_{LOAD}) connected from LOU_TL or LOU_TR to SPKLGND. R_{LOAD} = R_{HP} = ∞, R_{REC} = ∞, Z_{SPK} = ∞, C_{REF} = 2.2μF, C_{MICBIAS} = C_{REG} = 1μF, C_{C1N-C1P} = 1μF, C_{HPVDD} = C_{HPVSS} = 1μF. AV_{MICPRE_} = +20dB, AV_{MICPGA_} = 0dB, AV_{DACATTN} = 0dB, AV_{DACGAIN} = 0dB, AV_{ADCLVL} = 0dB, AV_{ADCGAIN} = 0dB, AV_{PGAIN_} = 0dB, AV_{HP_} = 0dB, AV_{REC} = 0dB, AV_{SPK_} = 0dB, MCLK = 12.288MHz, LRCLK = 48kHz, MAS = 1. T_A = T_{MIN} to T_{MAX}, unless otherwise noted. Typical values are at +25°C.) (Note 1)

PARAMETER	SYMBOL	CONDITIONS		MIN	TYP	MAX	UNITS
LINE INPUT TO RECEIVER AMPLIFIER PATH							
Dynamic Range (Note 4)	DR	Referenced to full-scale output level			94		dB
Total Harmonic Distortion + Noise	THD+N				-64		dB
Click-and-Pop Level	K _{CP}	Peak voltage, A-weighted, 32 samples per second, AV _{REC} = 0dB	Into shutdown		-51		dBV
			Out of shutdown		-49		
RECEIVER AMPLIFIER							
Output Power	P _{OUT}	R _{REC} = 32Ω, f = 1kHz, THD = 1%			83		mW
Full-Scale Output		(Note 7)			1		V _{RMS}
Volume Control (Note 5)	AV _{REC}	RECVOL = 0x00			-62		dB
		RECVOL = 0x1F			8		
Volume Control Step Size		+8dB to +6dB			0.5		dB
		+6dB to +0dB			1		
		0dB to -14dB			2		
		-14dB to -38dB			3		
		-38dB to -62dB			4		
Mute Attenuation		f = 1kHz			88		dB
Capacitive Drive Capability		No sustained oscillations	R _{REC} = 32Ω		500		pF
			R _{REC} = ∞		100		
DAC TO LINE OUT AMPLIFIER PATH							
Dynamic Range (Note 4)	DR	f _S = 48kHz, f = 1kHz		83	96		dB
Total Harmonic Distortion + Noise	THD+N	f = 1kHz, R _L = 1kΩ			-78	-72	dB
LINE INPUT TO LINE OUT AMPLIFIER PATH							
Dynamic Range (Note 4)	DR	Referenced to full-scale output level			92		dB
Total Harmonic Distortion + Noise	THD+N	f = 1kHz, R _L = 10kΩ			76		dB
Full-Scale Output		(Note 7)			2		V _{P-P}
Mute Attenuation		f = 1kHz			85		dB
Output Offset Voltage	V _{OS}	AV _{REC_} = -62dB			±3.0	±4	mV
Capacitive Drive Capability		No sustained oscillations, R _L = 1kΩ			500		pF

Stereo Audio Codec with FlexSound Technology

ELECTRICAL CHARACTERISTICS (continued)

(VAVDD = VPVDD = VD VDD = VD VDD S1 = VD VDD S2 = +1.8V, VSPKLVDD = VSPKRVDD = 3.7V. Speaker loads (ZSPK) connected between SPK_P and SPK_N. Receiver load (RREC) connected between RECP and REC N. Headphone loads (RHP) connected from HPL or HPR to HPGND. Line out loads (RLOAD) connected from LOU TL or LOU TR to SPKLGND. RLOAD = RHP = ∞, RREC = ∞, ZSPK = ∞, CREF = 2.2μF, CMICBIAS = CREG = 1μF, CC1N-C1P = 1μF, CHPVDD = CHPVSS = 1μF. AVMICPRE_ = +20dB, AVMICPGA_ = 0dB, AVDACATTN = 0dB, AVDACGAIN = 0dB, AVADCLVL = 0dB, AVADCGAIN = 0dB, AVPGAIN_ = 0dB, AVHP_ = 0dB, AVREC = 0dB, AVSPK_ = 0dB, MCLK = 12.288MHz, LRCLK = 48kHz, MAS = 1. TA = TMIN to TMAX, unless otherwise noted. Typical values are at +25°C.) (Note 1)

PARAMETER	SYMBOL	CONDITIONS		MIN	TYP	MAX	UNITS
DAC TO SPEAKER AMPLIFIER PATH							
Total Harmonic Distortion + Noise	THD+N	f = 1kHz, POUT = 200mW, ZSPK = 8Ω + 68μH			-68		dB
Crosstalk		SPKL to SPKR and SPKR to SPKL, POUT = 640mW, f = 1kHz			-88		dB
Output Noise					53		μVRMS
Click-and-Pop Level	KCP	Peak voltage, A-weighted, 32 samples per second, AVSPK_ = 0dB	Into shutdown		65		dBV
			Out of shutdown		66		
MIC INPUT TO SPEAKER AMPLIFIER PATH							
Dynamic Range (Note 4)	DR	Referenced to full-scale output level, AVSPK_ = 0dB			82		dB
Total Harmonic Distortion + Noise	THD+N	f = 1kHz, POUT = 200mW, RL = 8Ω + 68μH			71		dB
Click-and-Pop Level	KCP	Peak voltage, A-weighted, 32 samples per second, AVSPK_ = 0dB	Into shutdown		55		dBV
			Out of shutdown		52		
SPEAKER AMPLIFIER							
Output Power	POUT	f = 1kHz, THD = 1%, ZSPK = 8Ω + 68μH	VSPKLVDD = VSPKRVDD = 5.0V		1323		mW
			VSPKLVDD = VSPKRVDD = 4.2V		914		
			VSPKLVDD = VSPKRVDD = 3.7V		700		
			VSPKLVDD = VSPKRVDD = 3.2V		514		
Full-Scale Output		(Note 7)			2		VRMS
Volume Control	AVSPK_	(Note 5)	SPVOLL/SPVOLR = 0x00		-62		dB
			SPVOLL/SPVOLR = 0x1F		+8		
Volume Control Step Size			+8dB to +6dB		0.5		dB
			+6dB to +0dB		1		
			0dB to -14dB		2		
			-14dB to -38dB		3		
			-38dB to -64dB		4		
Mute Attenuation		f = 1kHz			86		dB
Output Offset Voltage	VOS	AVSPK_ = -61dB, TA = +25°C			±0.5	±3	mV

Stereo Audio Codec with FlexSound Technology

ELECTRICAL CHARACTERISTICS (continued)

(VAVDD = VPVDD = VD VDD = VD VDD S1 = VD VDD S2 = +1.8V, VSPKL VDD = VSPKR VDD = 3.7V. Speaker loads (ZSPK) connected between SPK_P and SPK_N. Receiver load (RREC) connected between RECP and REC N. Headphone loads (RHP) connected from HPL or HPR to HPGND. Line out loads (RLOAD) connected from LOU TL or LOU TR to SPK LGND. RLOAD = RHP = ∞, RREC = ∞, ZSPK = ∞, CREF = 2.2μF, CMICBIAS = CREG = 1μF, CC1N-C1P = 1μF, CHPVDD = CHPVSS = 1μF. AVMICPRE_ = +20dB, AVMICPGA_ = 0dB, AVDACATTN = 0dB, AVDACGAIN = 0dB, AVADCLVL = 0dB, AVADCGAIN = 0dB, AVPGAIN_ = 0dB, AVHP_ = 0dB, AVREC = 0dB, AVSPK_ = 0dB, MCLK = 12.288MHz, LRCLK = 48kHz, MAS = 1. TA = TMIN to TMAX, unless otherwise noted. Typical values are at +25°C.) (Note 1)

PARAMETER	SYMBOL	CONDITIONS	MIN	TYP	MAX	UNITS
EXCURSION LIMITER						
Upper Corner Frequency Range		DHPUCF = 001 to 100	400		1000	Hz
Lower Corner Frequency		DHPLCF = 01 to 10		400		Hz
Biquad Minimum Corner Frequency		DHPUCF = 000 (fixed mode)		100		Hz
		DHPUCF = 001		200		
		DHPUCF = 010		300		
		DHPUCF = 011		400		
		DHPUCF = 100		500		
Threshold Voltage		ZSPK = 8Ω + 68μH, VSPKL VDD = VSPKR VDD = 5.5V, AVSPK_ = 8dB	DHPTH = 000		0.34	Vp
			DHPTH = 111		0.95	
Release Time		ALCRLS = 101		0.25		s
		ALCRLS = 000		4		
POWER LIMITER						
Attenuation				-64		dB
Threshold		ZSPK = 8Ω + 68μH, VSPKL VDD = VSPKR VDD = 5.5V, AVSPK_ = 8dB	PWRTH = 0x1		0.08	W
			PWRTH = 0xF		1.23	
Time Constant 1	tPWR1	PWRT1 = 0x1		0.5		s
		PWRT1 = 0xF		8.7		
Time Constant 2	tPWR2	PWRT2 = 0x1 to 0xF		0.5		min
		PWRT2 = 0xF		8.7		
Weighting Factor	kPWR	PWRK = 000 to 111	12.5		100	%
DISTORTION LIMITER						
Distortion Limit		THDCLP = 0x1		< 1		%
		THDCLP = 0xF		24		
Release Time Constant		THDT1 = 000		0.76		s
		THDT1 = 111		6.2		

Stereo Audio Codec with FlexSound Technology

ELECTRICAL CHARACTERISTICS (continued)

(VAVDD = VPVDD = VD VDD = VD VDD S1 = VD VDD S2 = +1.8V, VSPKLVDD = VSPKRVD D = 3.7V. Speaker loads (ZSPK) connected between SPK_P and SPK_N. Receiver load (RREC) connected between RECP and REC N. Headphone loads (RHP) connected from HPL or HPR to HPGND. Line out loads (RLOAD) connected from LOU TL or LOU TR to SPKLGND. RLOAD = RHP = ∞, RREC = ∞, ZSPK = ∞, CREF = 2.2μF, CMICBIAS = CREG = 1μF, CC1N-C1P = 1μF, CHPVDD = CHPVSS = 1μF. AVMICPRE_ = +20dB, AVMICPGA_ = 0dB, AVDACATTN = 0dB, AVDACGAIN = 0dB, AVADCLVL = 0dB, AVADCGAIN = 0dB, AVPGAIN_ = 0dB, AVHP_ = 0dB, AVREC = 0dB, AVSPK_ = 0dB, MCLK = 12.288MHz, LRCLK = 48kHz, MAS = 1. TA = TMIN to TMAX, unless otherwise noted. Typical values are at +25°C.) (Note 1)

PARAMETER	SYMBOL	CONDITIONS		MIN	TYP	MAX	UNITS
DAC TO HEADPHONE AMPLIFIER PATH							
Dynamic Range (Note 4)	DR	fS = 48kHz	Master or slave mode	101		dB	
			Slave mode	97			
			Low power mode, TA = +25°C	95	97		
Total Harmonic Distortion + Noise	THD+N	f = 1kHz, POUT = 20mW	RHP = 16Ω	-85	-64	dB	
			RHP = 32Ω	-92			
Crosstalk		HPL to HPR and HPR to HPL, POUT = 5mW, f = 1kHz, RHP = 32Ω		79.5			dB
Power-Supply Rejection Ratio	PSRR	VAVDD = VPVDD = 1.65V to 2.0V		46	54	dB	
		f = 217Hz, VRIPPLE = 200mVP-P, AVHP_ = 0dB		72			
		f = 1kHz, VRIPPLE = 200mVP-P, AVHP_ = 0dB		63			
		f = 10kHz, VRIPPLE = 200mVP-P, AVHP_ = 0dB		43			
DAC Path Phase Delay		1kHz, 0dB input, highpass filter disabled measured from digital input to analog output	MODE = 0 (voice) 8kHz	2.2		ms	
			MODE = 0 (voice) 16kHz	1.1			
			MODE = 1 (music) 8kHz	4.5			
			MODE = 1 (music) 48kHz	0.76			
Gain Error				1	5		%
Channel Gain Mismatch				1			%
Click-and-Pop Level	KCP	Peak voltage, A-weighted, 32 samples per second, AVHP_ = 0dB	Into shutdown	-62		dBV	
			Out of shutdown	-63			
LINE INPUT TO HEADPHONE AMPLIFIER PATH							
Total Harmonic Distortion + Noise	THD+N	VIN = 1VP-P, f = 1kHz, RHP = 32Ω		81			dB
Dynamic Range (Note 4)				92.5			dB
Click-and-Pop Level	KCP	Peak voltage, A-weighted, 32 samples per second, AVHP_ = 0dB	Into shutdown	-62		dBV	
			Out of shutdown	-63			

Stereo Audio Codec with FlexSound Technology

ELECTRICAL CHARACTERISTICS (continued)

(VAVDD = VPVDD = VD VDD = VD VDD S1 = VD VDD S2 = +1.8V, VSPKLVDD = VSPKRVDD = 3.7V. Speaker loads (ZSPK) connected between SPK_P and SPK_N. Receiver load (RREC) connected between RECP and REC_N. Headphone loads (RHHP) connected from HPL or HPR to HPGND. Line out loads (RLOAD) connected from LOU_TL or LOU_TR to SPKLGND. RLOAD = RHHP = ∞, RREC = ∞, ZSPK = ∞, CREF = 2.2μF, CMICBIAS = CREG = 1μF, CC1N-C1P = 1μF, CHPVDD = CHPVSS = 1μF. AVMICPRE_ = +20dB, AVMICPGA_ = 0dB, AVDACATTN = 0dB, AVDACGAIN = 0dB, AVADCLVL = 0dB, AVADCGAIN = 0dB, AVPGAIN_ = 0dB, AVHP_ = 0dB, AVREC = 0dB, AVSPK_ = 0dB, MCLK = 12.288MHz, LRCLK = 48kHz, MAS = 1. TA = TMIN to TMAX, unless otherwise noted. Typical values are at +25°C.) (Note 1)

PARAMETER	SYMBOL	CONDITIONS	MIN	TYP	MAX	UNITS
HEADPHONE AMPLIFIER						
Output Power	POUT	f = 1kHz, THD = 1%	RHP = 32Ω	30		mW
			RHP = 16Ω	38		
Positive Charge-Pump Output Voltage	HPVDD	VOUT ≤ VPVDD × 0.25V, RHP = ∞		PVDD/2		V
		VOUT > VPVDD × 0.25V, RHP = ∞		PVDD		
Negative Charge-Pump Output Voltage	HPVSS	VOUT ≤ VPVDD × 0.25V, RHP = ∞		-PVDD/2		V
		VOUT > VPVDD × 0.25V, RHP = ∞		-PVDD		
Output Voltage Threshold (Output Voltage at which the Charge Pump Switches Modes; VOUT Rising; Transition from Split to Invert Mode)	VTH	RL = ∞		±PVDD × 0.25		V
Full-Scale Output		(Note 7)		1		VRMS
Volume Control	AVHP_	(Note 5)	HPVOL_ = 0x00	-67		dB
			HPVOL_ = 0x1F	+3		
Volume Control Step Size			+3dB to +1dB	0.5		dB
			+1dB to -5dB	1		
			-5dB to -19dB	2		
			-19dB to -43dB	3		
			-43dB to -67dB	4		
Mute Attenuation		f = 1kHz		100		dB
Output Offset Voltage	VOS	AVHP_ = -67dB	TA = +25°C	±0.5	±1	mV
			TA = TMIN to TMAX		±3	
Capacitive Drive Capability		No sustained oscillations	RHP = 32Ω	500		pF
			RHP = ∞	100		
SPEAKER BYPASS SWITCH						
On-Resistance	RON	ISPKL_ = 100mA, SPKBYP = 1, VRXIN_ = [0V, VSPKLVDD]		2.8		Ω
Total Harmonic Distortion + Noise	THD+N	VIN = 2VP-P, VCM = VSPKLVDD/2, ZSPK = 8Ω + 68μH, f = 1kHz, SPKBYP = 1	RS = 10Ω	60		dB
			RS = 0Ω	60		
Off-Isolation		VIN = 2VP-P, VCM = VSPKLVDD/2, ZSPK = 8Ω + 68μH, f = 1kHz		96		dB
Off-Leakage Current		VRXIN_ = [0V, VSPKLVDD], VSPKL_ = [VSPKLVDD, 0V]		-20	+20	μA

Stereo Audio Codec with FlexSound Technology

ELECTRICAL CHARACTERISTICS (continued)

(VAVDD = VPVDD = VD VDD = VD VDD S1 = VD VDD S2 = +1.8V, VSPKLVDD = VSPKRVDD = 3.7V. Speaker loads (ZSPK) connected between SPK_P and SPK_N. Receiver load (RREC) connected between RECP and REC_N. Headphone loads (RHP) connected from HPL or HPR to HPGND. Line out loads (RLOAD) connected from LOU_TL or LOU_TR to SPKLGND. RLOAD = RHP = ∞, RREC = ∞, ZSPK = ∞, CREF = 2.2μF, CMICBIAS = CREG = 1μF, CC1N-C1P = 1μF, CHPVDD = CHPVSS = 1μF. AVMICPRE_ = +20dB, AVMICPGA_ = 0dB, AVDACATTN = 0dB, AVDACGAIN = 0dB, AVADCLVL = 0dB, AVADCGAIN = 0dB, AVPGAIN_ = 0dB, AVHP_ = 0dB, AVREC = 0dB, AVSPK_ = 0dB, MCLK = 12.288MHz, LRCLK = 48kHz, MAS = 1. TA = TMIN to TMAX, unless otherwise noted. Typical values are at +25°C.) (Note 1)

PARAMETER	SYMBOL	CONDITIONS	MIN	TYP	MAX	UNITS
RECEIVER BYPASS SWITCH						
On-Resistance	RON	I _{RECP} = 100mA, RECBYP = 1, V _{REC_N} = [0V, V _{SPKLVDD}]		2		Ω
Total Harmonic Distortion + Noise	THD+N	V _{IN} = 2V _{P-P} , V _{CM} = V _{SPKLVDD} /2, Z _{SPK} = 8Ω + 68μH, f = 1kHz, RECBYP = 1, R _S = 0Ω		60		dB
Off-Isolation		V _{IN} = 2V _{P-P} , V _{CM} = V _{SPKLVDD} /2, Z _{SPK} = 8Ω + 68μH, f = 1kHz		84		dB
Off-Leakage Current		V _{RECP} = [0V, V _{SPKLVDD}], V _{REC_N} = [V _{SPKLVDD} , 0V]	-15		+15	μA
JACK DETECTION						
JACKSNS Threshold		$\overline{\text{SHDN}} = 1$, JACKSNS rising	0.92 x	0.95 x	0.98 x	V
		$\overline{\text{SHDN}} = 0$, JKSNS	SPKLVDD - 0.7			
JACKSNS Sense Voltage		$\overline{\text{SHDN}} = 0$	SPKLVDD			V
JACKSNS Sense Current		V _{JACKSNS} = 0V		4	10	μA
BATTERY ADC						
Input Voltage Range			2.6		5.6	V
LSB Size				0.1		V

DIGITAL INPUT/OUTPUT CHARACTERISTICS

(VAVDD = VPVDD = VD VDD = VD VDD S1 = VD VDD S2 = +1.8V, VSPKLVDD = VSPKRVDD = 3.7V, TA = +25°C, unless otherwise noted.) (Note 1)

PARAMETER	SYMBOL	CONDITIONS	MIN	TYP	MAX	UNITS
MCLK						
Input High Voltage	V _{IH}		1.2			V
Input Low Voltage	V _{IL}				0.6	V
Input Leakage Current	I _{IH} , I _{IL}	VD VDD = 2.0V, V _{IN} = 0V, 5.5V; TA = +25°C	-1		+1	μA
Input Capacitance				10		pF
SDINS1, BCLKS1, LRCLKS1—INPUT						
Input High Voltage	V _{IH}		0.7 x			V
Input Low Voltage	V _{IL}				0.29 x	V
Input Hysteresis				200		mV
Input Leakage Current	I _{IH} , I _{IL}	VD VDD S1 = 3.6V, V _{IN} = 0V, 3.6V; TA = +25°C	-1		+1	μA
Input Capacitance				10		pF

Stereo Audio Codec with FlexSound Technology

DIGITAL INPUT/OUTPUT CHARACTERISTICS (continued)

(VAVDD = VPVDD = VD VDD = VD VDDS1 = VD VDDS2 = +1.8V, VSPKL VDD = VSPKR VDD = 3.7V, T_A = +25°C, unless otherwise noted.)
(Note 1)

PARAMETER	SYMBOL	CONDITIONS	MIN	TYP	MAX	UNITS
BCLKS1, LRCLKS1, SDOUTS1—OUTPUT						
Output Low Voltage	V _{OL}	VDVDDS1 = 1.65V, I _{OL} = 3mA			0.4	V
Output High Voltage	V _{OH}	VDVDDS1 = 1.65V, I _{OH} = 3mA	DVDDS1 - 0.4			V
Input Leakage Current	I _{IH} , I _{IL}	VDVDD = 2.0V, V _{IN} = 0V, 5.5V; T _A = +25°C, high-impedance state	-1		+1	μA
SDINS2, BCLKS2, LRCLKS2—INPUT						
Input High Voltage	V _{IH}		0.7 x DVDDS2			V
Input Low Voltage	V _{IL}			0.29 x DVDDS2		V
Input Hysteresis				200		mV
Input Leakage Current	I _{IH} , I _{IL}	VDVDDS2 = 3.6V, V _{IN} = 0V, 3.6V; T _A = +25°C	-1		+1	μA
Input Capacitance				10		pF
BCLKS2, LRCLKS2, SDOUTS2—OUTPUT						
Output Low Voltage	V _{OL}	VDVDDS2 = 1.65V, I _{OL} = 3mA			0.4	V
Output High Voltage	V _{OH}	VDVDDS2 = 1.65V, I _{OH} = 3mA	DVDDS2 - 0.4			V
Input Leakage Current	I _{IH} , I _{IL}	VDVDD = 2.0V, V _{IN} = 0V, 5.5V; T _A = +25°C, high-impedance state	-1		+1	μA
SDA, SCL—INPUT						
Input High Voltage	V _{IH}		0.7 x DVDD			V
Input Low Voltage	V _{IL}			0.3 x DVDD		V
Input Hysteresis				210		mV
Input Leakage Current	I _{IH} , I _{IL}	VDVDD = 2.0V, V _{IN} = 0V, 5.5V; T _A = +25°C	-1		+1	μA
Input Capacitance				10		pF
SDA, $\overline{\text{IRQ}}$—OUTPUT						
Output High Current	I _{OH}	V _{OUT} = 5.5V, T _A = +25°C			1	mA
Output Low Voltage	V _{OL}	VDVDD = 1.65V, I _{OL} = 3mA			0.2 x DVDD	V
DIGMICDATA—INPUT						
Input High Voltage	V _{IH}		0.65 x DVDD			V
Input Low Voltage	V _{IL}			0.35 x DVDD		V
Input Hysteresis				125		mV
Input Leakage Current	I _{IH} , I _{IL}	VDVDD = 2.0V, V _{IN} = 0V, 2.0V; T _A = +25°C	-25		+25	μA
Input Capacitance				10		pF

MAX98088

Stereo Audio Codec with FlexSound Technology

DIGITAL INPUT/OUTPUT CHARACTERISTICS (continued)

(VAVDD = VPVDD = VD VDD = VD VDDS1 = VD VDDS2 = +1.8V, VSPKL VDD = VSPKR VDD = 3.7V, T_A = +25°C, unless otherwise noted.)
(Note 1)

PARAMETER	SYMBOL	CONDITIONS	MIN	TYP	MAX	UNITS
DIGMICCLK—OUTPUT						
Output Low Voltage	V _{OL}	VD VDD = 1.65V, I _{OL} = 1mA			0.4	V
Output High Voltage	V _{OH}	VD VDD = 1.65V, I _{OH} = 1mA	VD VDD - 0.4			V

INPUT CLOCK CHARACTERISTICS

(VAVDD = VPVDD = VD VDD = VD VDDS1 = VD VDDS2 = +1.8V, VSPKL VDD = VSPKR VDD = 3.7V, T_A = +25°C, unless otherwise noted.)
(Note 1)

PARAMETER	SYMBOL	CONDITIONS	MIN	TYP	MAX	UNITS
MCLK Input Frequency	f _{MCLK}		10		60	MHz
MCLK Input Duty Cycle		PSCLK = 01	40	50	60	%
		PSCLK = 10 or 11	30		70	
Maximum MCLK Input Jitter				100		psRMS
LRCLK Sample Rate (Note 8)		DHF ₋ = 0	8		48	kHz
		DHF ₋ = 1	48		96	
DAI1 LRCLK Average Frequency Error (Note 9)		FREQ1 = 0x8 to 0xF	0		0	%
		FREQ1 = 0x0	-0.025		+0.025	
DAI2 LRCLK Average Frequency Error (Note 9)			-0.025		+0.025	%
PLL Lock Time		Rapid lock mode		2	7	ms
		Nonrapid lock mode		12	25	
Maximum LRCLK Jitter to Maintain PLL Lock					100	ns
Soft-Start/Stop Time				10		ms

Stereo Audio Codec with FlexSound Technology

AUDIO INTERFACE TIMING CHARACTERISTICS

(VAVDD = VPVDD = VDvDD = VDvDdS1 = VDvDdS2 = +1.8V, VSPKLVDD = VSPKRVDD = 3.7V, TA = +25°C, unless otherwise noted.)
(Note 1)

PARAMETER	SYMBOL	CONDITIONS	MIN	TYP	MAX	UNITS
BCLK Cycle Time	t _{BCLK}	Slave mode	90			ns
BCLK High Time	t _{BCLKH}	Slave mode	20			ns
BCLK Low Time	t _{BCLKL}	Slave mode	20			ns
BCLK or LRCLK Rise and Fall Time	t _R , t _F	Master mode, C _L = 15pF		5		ns
SDIN to BCLK Setup Time	t _{SETUP}		20			ns
LRCLK to BCLK Setup Time	t _{SYNCSET}	Slave mode	20			ns
SDIN to BCLK Hold Time	t _{HOLD}		20			ns
LRCLK to BCLK Hold Time	t _{SYNHOLD}	Slave mode	20			ns
Minimum Delay Time from LSB BCLK Falling Edge to High-Impedance State	t _{HIZOUT}	Master mode, TDM ₋ = 1		42		ns
LRCLK Rising Edge to SDOU MSB Delay	t _{SYNCTX}	C _L = 30pF, TDM ₋ = 1, FSW ₋ = 1			50	ns
BCLK to SDOU Delay	t _{CLKTX}	C _L = 30pF	TDM ₋ = 1, BCLK rising edge		50	ns
			TDM ₋ = 0		50	
Delay Time from BCLK to LRCLK	t _{CLKSYNC}	Master mode	TDM ₋ = 1		-15	ns
			TDM ₋ = 0		0.8 x t _{BCLKL}	
Delay Time from LRCLK to BCLK After LSB	t _{ENDSYNC}	Master mode	TDM ₋ = 1, FSW ₋ = 1		20	ns

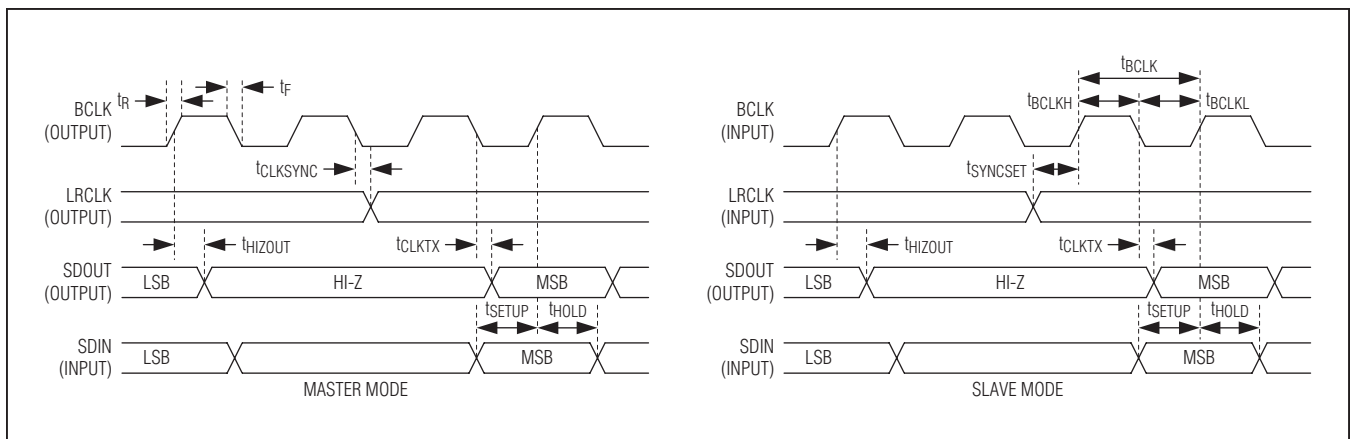

Figure 1. Non-TDM Audio Interface Timing Diagrams (TDM₋ = 0)

Stereo Audio Codec with FlexSound Technology

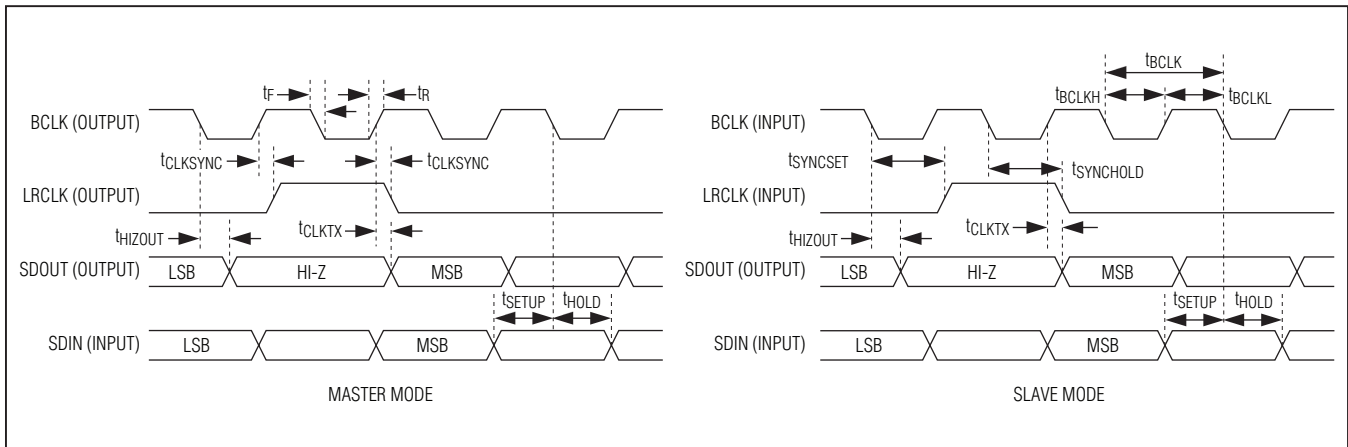

Figure 2. TDM Audio Interface Timing Diagram ($TDM_ = 1, FSW_ = 0$)

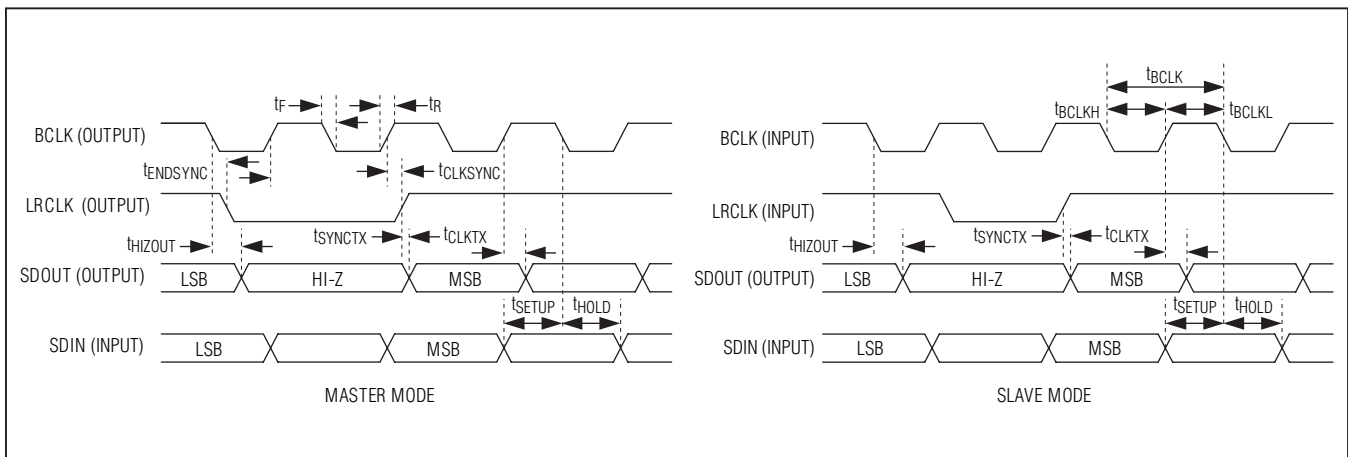

Figure 3. TDM Audio Interface Timing Diagram ($TDM_ = 1, FSW_ = 1$)

DIGITAL MICROPHONE TIMING CHARACTERISTICS

($V_{AVDD} = V_{PVDD} = V_{DVDD} = V_{DVDD1} = V_{DVDD2} = +1.8V$, $V_{SPKLVDD} = V_{SPKRVDD} = 3.7V$, $T_A = +25^\circ C$, unless otherwise noted.)
(Note 1)

PARAMETER	SYMBOL	CONDITIONS	MIN	TYP	MAX	UNITS
DIGMICCLK Frequency	f _{MICCLK}	MICCLK = 00		MCLK/8		MHz
		MICCLK = 01		MCLK/6		
DIGMICDATA to DIGMICCLK Setup Time	t _{SU,MIC}	Either clock edge	20			ns
DIGMICDATA to DIGMICCLK Hold Time	t _{HD,MIC}	Either clock edge	0			ns

MAX98088

Stereo Audio Codec with FlexSound Technology

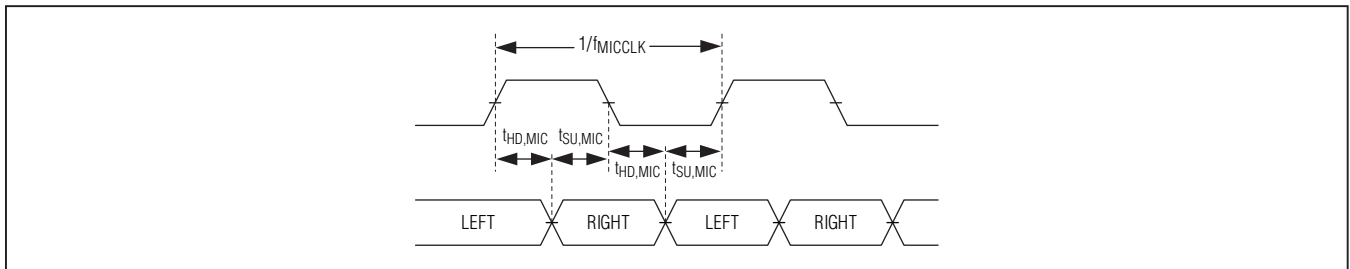

Figure 4. Digital Microphone Timing Diagram

I²C TIMING CHARACTERISTICS

($V_{AVDD} = V_{PVDD} = V_{DVDD} = V_{DVDDS1} = V_{DVDDS2} = +1.8V$, $V_{SPKLVDD} = V_{SPKRVD} = 3.7V$, $T_A = +25^\circ C$, unless otherwise noted.)
(Note 1)

PARAMETER	SYMBOL	CONDITIONS	MIN	TYP	MAX	UNITS
Serial-Clock Frequency	f_{SCL}	Guaranteed by SCL pulse-width low and high	0		400	kHz
Bus Free Time Between STOP and START Conditions	t_{BUF}		1.3			μs
Hold Time (Repeated) START Condition	$t_{HD,STA}$		0.6			μs
SCL Pulse-Width Low	t_{LOW}		1.3			μs
SCL Pulse-Width High	t_{HIGH}		0.6			μs
Setup Time for a Repeated START Condition	$t_{SU,STA}$		0.6			μs
Data Hold Time	$t_{HD,DAT}$	$R_{PU} = 475\Omega$, $C_B = 100pF$, $400pF$	0		900	ns
Data Setup Time	$t_{SU,DAT}$		100			ns
SDA and SCL Receiving Rise Time	t_R	(Note 10)	$20 + 0.1C_B$		300	ns
SDA and SCL Receiving Fall Time	t_F	(Note 10)	$20 + 0.1C_B$		300	ns
SDA Transmitting Fall Time	t_F	$R_{PU} = 475\Omega$, $C_B = 100pF$, $400pF$ (Note 10)	$20 + 0.05C_B$		250	ns
Setup Time for STOP Condition	$t_{SU,STO}$		0.6			μs
Bus Capacitance	C_B	Guaranteed by SDA transmitting fall time			400	pF
Pulse Width of Suppressed Spike	t_{SP}		0		50	ns

Stereo Audio Codec with FlexSound Technology

I²C TIMING CHARACTERISTICS (continued)

(V_{AVDD} = V_{PVDD} = V_{DVDD} = V_{DVDDS1} = V_{DVDDS2} = +1.8V, V_{SPKLVD} = V_{SPKRVD} = 3.7V. T_A = +25°C, unless otherwise noted.)
(Note 1)

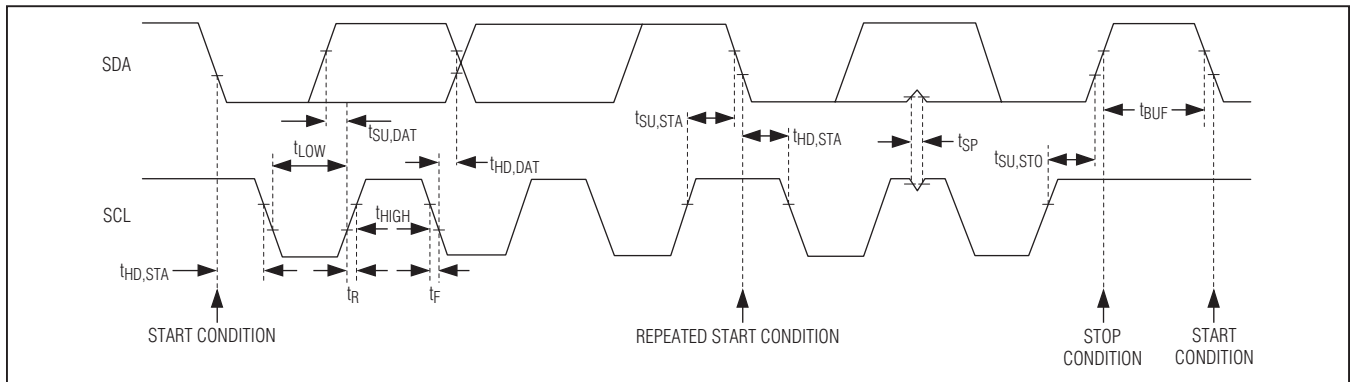

Figure 5. I²C Interface Timing Diagram

- Note 1:** The IC is 100% production tested at T_A = +25°C. Specifications over temperature limits are guaranteed by design.
- Note 2:** Analog supply current = I_{AVDD} + I_{HPVDD}. Speaker supply current = I_{SPKLVD} + I_{SPKRVD}. Digital supply current = I_{DVDD} + I_{DVDDS1} + I_{DVDDS2}.
- Note 3:** Clocking all zeros into the DAC.
- Note 4:** Dynamic range measured using the EIAJ method. -60dBFS, 1kHz output signal, A-weighted and normalized to 0dBFS. f = 20Hz to 20kHz.
- Note 5:** Gain measured relative to the 0dB setting.
- Note 6:** The filter specification is accurate only for synchronous clocking modes, where NI is a multiple of 0x1000.
- Note 7:** 0dBFS for DAC input. 1V_{p-p} for INA/INB inputs.
- Note 8:** LRCLK may be any rate in the indicated range. Asynchronous or noninteger MCLK/LRCLK ratios may exhibit some full-scale performance degradation compared to synchronous integer related MCLK/LRCLK ratios.
- Note 9:** In master-mode operation, the accuracy of the MCLK input proportionally determines the accuracy of the sample clock rate.
- Note 10:** CB is in pF.

Power Consumption

(V_{AVDD} = V_{PVDD} = V_{DVDD} = V_{DVDDS1} = V_{DVDDS2} = 1.8V, V_{SPKLVD} = V_{SPKRVD} = 3.7V)

MODE	I _{AVDD} (mA)	I _{PVDD} (mA)	I _{SPKVDD} + I _{SPKLVDD} (mA)	I _{DVDD} (mA)	I _{DVDDS1} + I _{DVDDS2} (mA)	POWER (mW)	DYNAMIC RANGE (dB)
PLAYBACK TO HEADPHONE ONLY							
DAC Playback 48kHz Stereo HP DAC → HP Low power mode, 24-bit, music filters, 256Fs	1.25	0.47	0.00	1.35	0.01	5.55	97
DAC Playback 48kHz Stereo HP DAC → HP Low power mode, 24-bit, music filters, 256Fs, 0.1mW/channel, R _{HP} = 32Ω	1.25	1.81	0.00	1.56	0.01	8.32	97

MAX98088

Stereo Audio Codec with FlexSound Technology

Power Consumption (continued)

($V_{AVDD} = V_{PVDD} = V_{DVDD} = V_{DVDDS1} = V_{DVDDS2} = 1.8V$, $V_{SPKLVDD} = V_{SPKRVD} = 3.7V$)

MODE	I _{AVDD} (mA)	I _{PVDD} (mA)	I _{SPKVDD} + I _{SPKLVDD} (mA)	I _{DVDD} (mA)	I _{DVDDS1} + I _{DVDDS2} (mA)	POWER (mW)	DYNAMIC RANGE (dB)
DAC Playback 48kHz Stereo HP DAC → HP 24-bit, music filters, 256Fs	2.04	1.27	0.00	1.53	0.01	8.72	101
DAC Playback 48kHz Stereo HP DAC → HP 24-bit, music filters, 256Fs, 0.1mW/ channel, R _{HP} = 32Ω	2.04	2.11	0.00	1.74	0.01	10.63	101
DAC Playback 44.1kHz Stereo HP DAC → HP 24-bit, music filters	2.03	1.27	0.00	1.41	0.01	8.46	100
DAC Playback 44.1kHz Stereo HP DAC → HP Low power mode, 24-bit, music filters	1.25	0.47	0.00	1.25	0.01	5.34	97
DAC Playback 8kHz Stereo HP DAC → HP 16-bit, voice filters	2.04	1.27	0.00	1.07	0.00	7.89	95
DAC Playback 8kHz Stereo HP DAC → HP 16-bit, low power mode, voice filters	1.26	0.47	0.00	0.90	0.00	4.72	94
DAC Playback 8kHz Mono HP DAC → HP 16-bit, low power mode, voice filters	0.77	0.29	0.00	0.79	0.00	3.33	93.7
Line Playback Stereo HP INA → HP Single-ended inputs	2.40	1.27	0.00	0.02	0.00	6.67	95
DAC PLAYBACK TO CLASS D SPEAKER							
DAC Playback 48kHz Stereo SPK DAC → SPK 24-bit, music filters	2.31	0.00	6.33	2.14	0.01	31.44	86

MAX98088

Stereo Audio Codec with FlexSound Technology

Power Consumption (continued)

($V_{AVDD} = V_{PVDD} = V_{DVDD} = V_{DVDDS1} = V_{DVDDS2} = 1.8V$, $V_{SPKLVDD} = V_{SPKRVDD} = 3.7V$)

MODE	I _{AVDD} (mA)	I _{PVDD} (mA)	I _{SPKVDD} + I _{SPKLVDD} (mA)	I _{DVDD} (mA)	I _{DVDDS1} + I _{DVDDS2} (mA)	POWER (mW)	DYNAMIC RANGE (dB)
DAC Playback 48kHz Mono SPK DAC → SPK 24-bit, music filters	1.35	0.00	3.23	1.84	0.01	17.69	86
Line Playback Mono SPK INA → SPKL Differential inputs	1.01	0.00	3.24	0.03	0.00	13.83	83
FULL DUPLEX							
Full-Duplex 8kHz Mono RCV MIC1 → ADC DAC → REC 16-bit, voice filters	6.32	0.00	1.54	1.24	0.01	19.33	Record = 87 Playback = 94
Full-Duplex 8kHz Stereo HP MIC1/2 → ADC DAC → HP 16-bit, mixer, voice filters	11.19	1.27	0.48	1.28	0.01	26.43	Record = 87 Playback = 96
Full-Duplex 8kHz Stereo HP MIC1/2 → ADC DAC → HP 16-bit, low power mode, voice filters	7.12	0.47	0.48	1.10	0.02	17.44	Record = 87 Playback = 94
LINE RECORD							
Line Stereo Record 48kHz INA → ADC 24-bit, low power, music filters	6.19	0.00	0.20	1.31	0.15	14.47	91
Line Stereo Record 48kHz INA → ADC Direct pin input, 24bit, low power, music filters	5.69	0.00	0.20	1.31	0.12	13.53	93

Stereo Audio Codec with FlexSound Technology

Typical Operating Characteristics

($V_{AVDD} = V_{PVDD} = V_{DVDD} = V_{DVDDS1} = V_{DVDDS2} = +1.8V$, $V_{SPKLVDD} = V_{SPKRVDD} = 3.7V$. Speaker loads (Z_{SPK}) connected between SPK_P and SPK_N . Receiver load (R_{REC}) connected between $RECP$ and $RECN$. Headphone loads (R_{HP}) connected from HPL or HPR to $HPGND$. $R_{HP} = \infty$, $R_{REC} = \infty$, $Z_{SPK} = \infty$, $C_{REF} = 2.2\mu F$, $C_{MICBIAS} = C_{REG} = 1\mu F$, $C_{C1N-C1P} = 1\mu F$, $C_{HPVDD} = C_{HPVSS} = 1\mu F$. $AV_{MICPRE_} = +20dB$, $AV_{MICPGA_} = 0dB$, $AV_{DACATTN} = 0dB$, $AV_{DACGAIN} = 0dB$, $AV_{ADCLVL} = 0dB$, $AV_{ADCGAIN} = 0dB$, $AV_{PGAIN_} = 0dB$, $AV_{HP_} = 0dB$, $AV_{REC} = 0dB$, $AV_{SPK_} = 0dB$, $MCLK = 12.288MHz$, $LRCLK = 48kHz$, $MAS = 1$. $T_A = +25^\circ C$, unless otherwise noted.)

Microphone to ADC

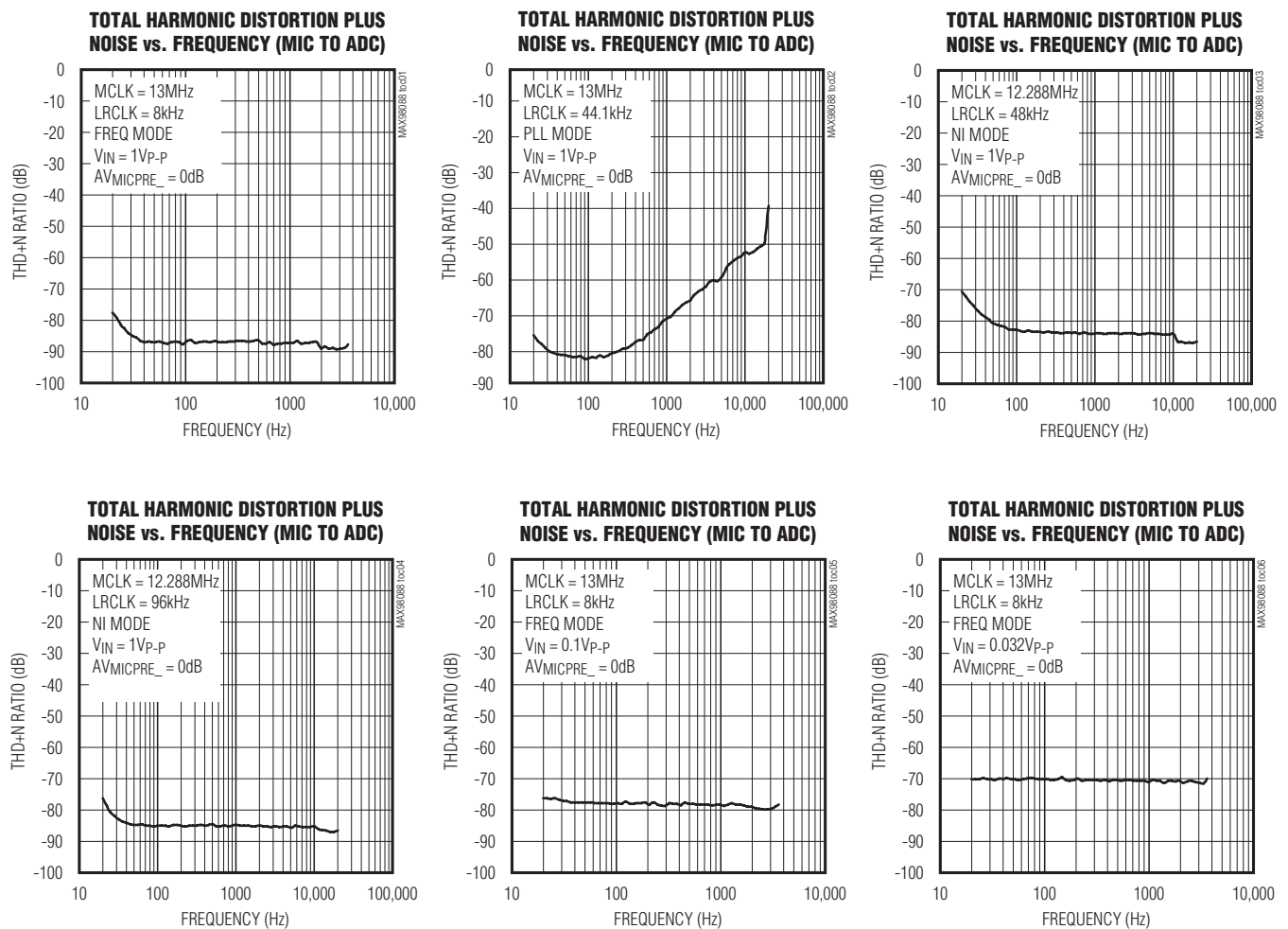

Stereo Audio Codec with FlexSound Technology

Typical Operating Characteristics (continued)

($V_{AVDD} = V_{PVDD} = V_{DVDD} = V_{DVDDS1} = V_{DVDDS2} = +1.8V$, $V_{SPKLVDD} = V_{SPKRVDD} = 3.7V$. Speaker loads (Z_{SPK}) connected between SPK_P and SPK_N. Receiver load (R_{REC}) connected between RECP and RECN. Headphone loads (R_{HP}) connected from HPL or HPR to HPGND. $R_{HP} = \infty$, $R_{REC} = \infty$, $Z_{SPK} = \infty$, $C_{REF} = 2.2\mu F$, $C_{MICBIAS} = C_{REG} = 1\mu F$, $C_{C1N-C1P} = 1\mu F$, $C_{HPVDD} = C_{HPVSS} = 1\mu F$. $AV_{MICPRE_} = +20dB$, $AV_{MICPGA_} = 0dB$, $AV_{DACATTN} = 0dB$, $AV_{DACGAIN} = 0dB$, $AV_{ADCLVL} = 0dB$, $AV_{ADCGAIN} = 0dB$, $AV_{PGAIN_} = 0dB$, $AV_{HP_} = 0dB$, $AV_{REC} = 0dB$, $AV_{SPK_} = 0dB$, $MCLK = 12.288MHz$, $LRCLK = 48kHz$, $MAS = 1$. $T_A = +25^\circ C$, unless otherwise noted.)

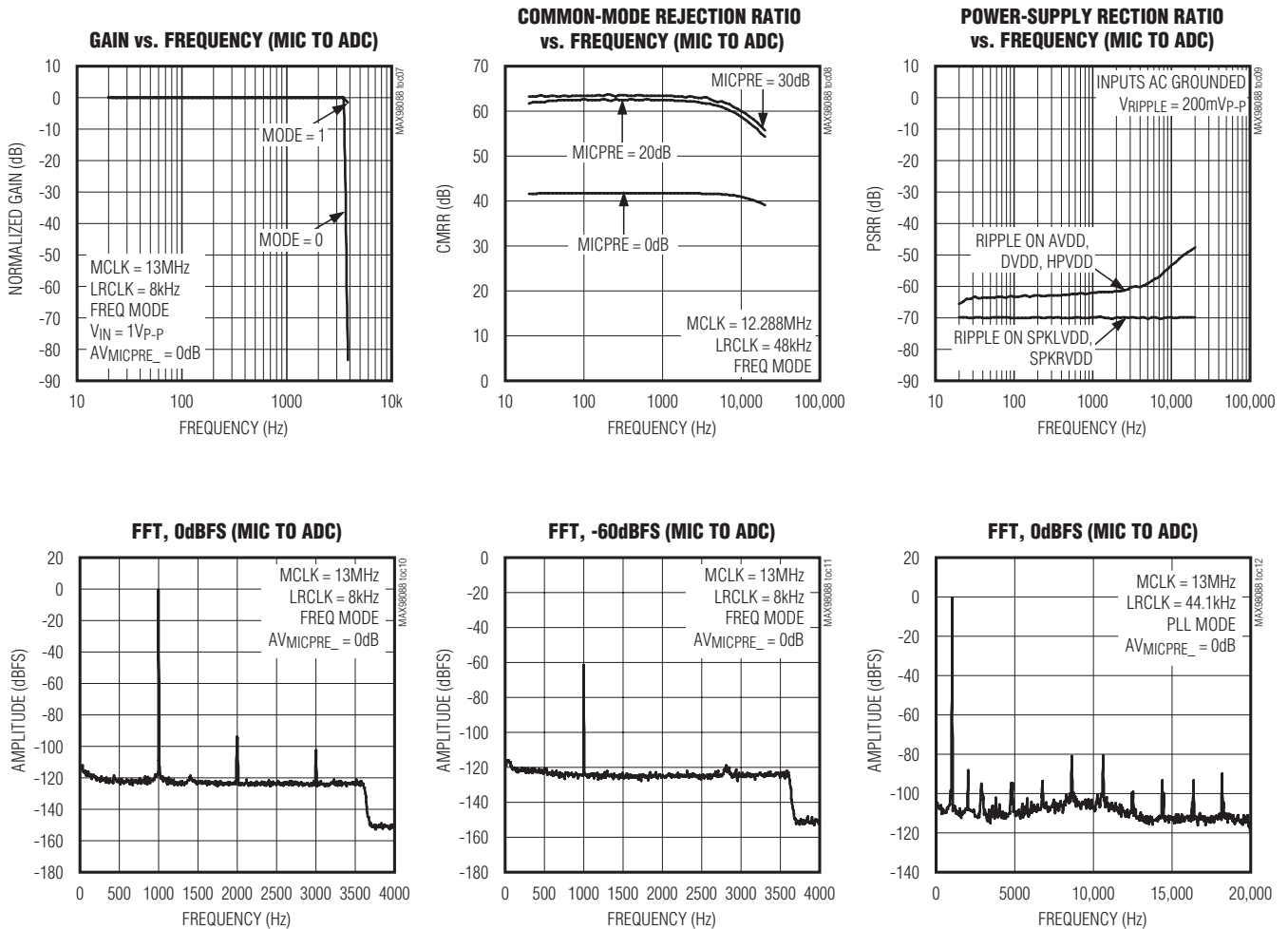

MAX98088

Stereo Audio Codec with FlexSound Technology

Typical Operating Characteristics (continued)

($V_{AVDD} = V_{PVDD} = V_{DVDD} = V_{DVDDS1} = V_{DVDDS2} = +1.8V$, $V_{SPKLVDD} = V_{SPKRVD} = 3.7V$. Speaker loads (Z_{SPK}) connected between SPK_P and SPK_N. Receiver load (R_{REC}) connected between RECP and RECN. Headphone loads (R_{HP}) connected from HPL or HPR to HPGND. $R_{HP} = \infty$, $R_{REC} = \infty$, $Z_{SPK} = \infty$, $C_{REF} = 2.2\mu F$, $C_{MICBIAS} = C_{REG} = 1\mu F$, $C_{C1N-C1P} = 1\mu F$, $C_{HPVDD} = C_{HPVSS} = 1\mu F$. $AV_{MICPRE_} = +20dB$, $AV_{MICPGA_} = 0dB$, $AV_{DACATTN} = 0dB$, $AV_{DACGAIN} = 0dB$, $AV_{ADCLVL} = 0dB$, $AV_{ADCGAIN} = 0dB$, $AV_{PGAIN_} = 0dB$, $AV_{HP_} = 0dB$, $AV_{REC} = 0dB$, $AV_{SPK_} = 0dB$, $MCLK = 12.288MHz$, $LRCLK = 48kHz$, $MAS = 1$. $T_A = +25^\circ C$, unless otherwise noted.)

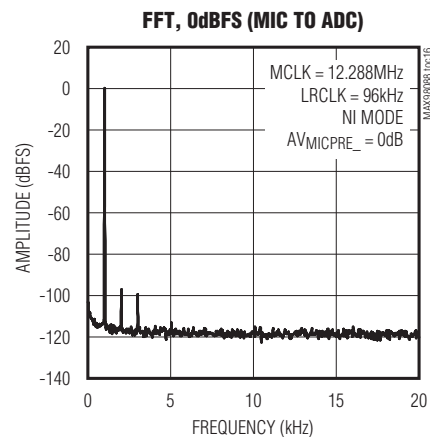
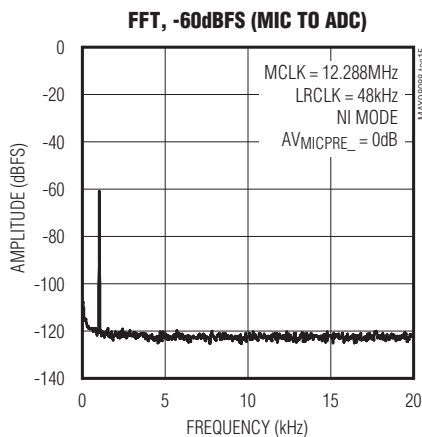
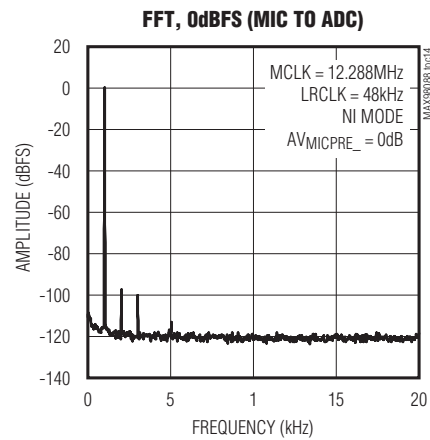
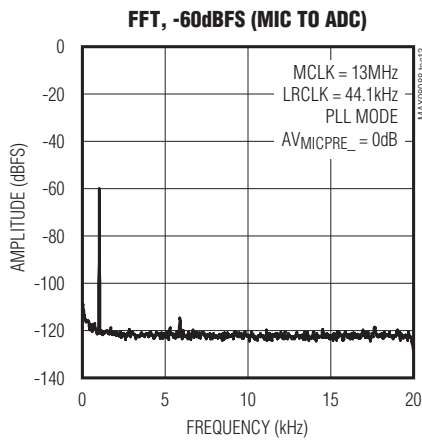

MAX98088

Stereo Audio Codec with FlexSound Technology

Typical Operating Characteristics (continued)

($V_{AVDD} = V_{PVDD} = V_{DVDD} = V_{DVDDS1} = V_{DVDDS2} = +1.8V$, $V_{SPKLVDD} = V_{SPKRVDD} = 3.7V$. Speaker loads (Z_{SPK}) connected between SPK_P and SPK_N . Receiver load (R_{REC}) connected between $RECP$ and $RECN$. Headphone loads (R_{HP}) connected from HPL or HPR to $HPGND$. $R_{HP} = \infty$, $R_{REC} = \infty$, $Z_{SPK} = \infty$, $C_{REF} = 2.2\mu F$, $C_{MICBIAS} = C_{REG} = 1\mu F$, $C_{C1N-C1P} = 1\mu F$, $C_{HPVDD} = C_{HPVSS} = 1\mu F$. $AV_{MICPRE_} = +20dB$, $AV_{MICPGA_} = 0dB$, $AV_{DACATTN} = 0dB$, $AV_{DACGAIN} = 0dB$, $AV_{ADCLVL} = 0dB$, $AV_{ADCGAIN} = 0dB$, $AV_{PGAIN_} = 0dB$, $AV_{HP_} = 0dB$, $AV_{REC} = 0dB$, $AV_{SPK_} = 0dB$, $MCLK = 12.288MHz$, $LRCLK = 48kHz$, $MAS = 1$. $T_A = +25^\circ C$, unless otherwise noted.)

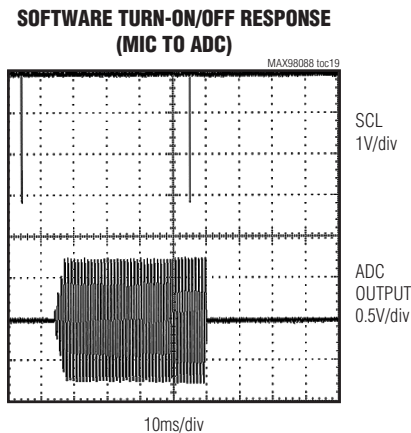
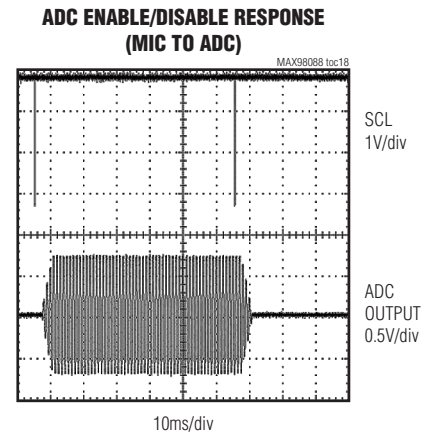
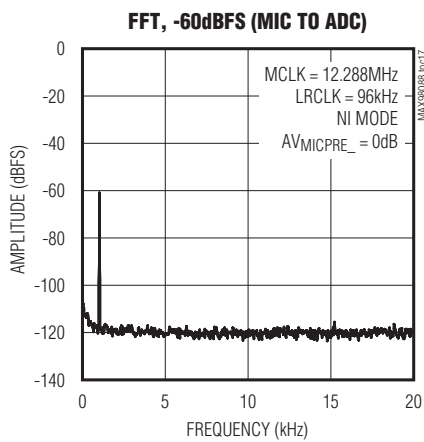

Stereo Audio Codec with FlexSound Technology

Typical Operating Characteristics (continued)

($V_{AVDD} = V_{PVDD} = V_{DVDD} = V_{DVDDS1} = V_{DVDDS2} = +1.8V$, $V_{SPKLVDD} = V_{SPKRVDD} = 3.7V$. Speaker loads (Z_{SPK}) connected between SPK_P and SPK_N. Receiver load (R_{REC}) connected between RECP and RECN. Headphone loads (R_{HP}) connected from HPL or HPR to HPGND. $R_{HP} = \infty$, $R_{REC} = \infty$, $Z_{SPK} = \infty$, $C_{REF} = 2.2\mu F$, $C_{MICBIAS} = C_{REG} = 1\mu F$, $C_{C1N-C1P} = 1\mu F$, $C_{HPVDD} = C_{HPVSS} = 1\mu F$. $AV_{MICPRE_} = +20dB$, $AV_{MICPGA_} = 0dB$, $AV_{DACATTN} = 0dB$, $AV_{DACGAIN} = 0dB$, $AV_{ADCLVL} = 0dB$, $AV_{ADCGAIN} = 0dB$, $AV_{PGAIN_} = 0dB$, $AV_{HP_} = 0dB$, $AV_{REC} = 0dB$, $AV_{SPK_} = 0dB$, $MCLK = 12.288MHz$, $LRCLK = 48kHz$, $MAS = 1$. $T_A = +25^\circ C$, unless otherwise noted.)

Line to ADC

TOTAL HARMONIC DISTORTION PLUS NOISE vs. FREQUENCY (LINE TO ADC)

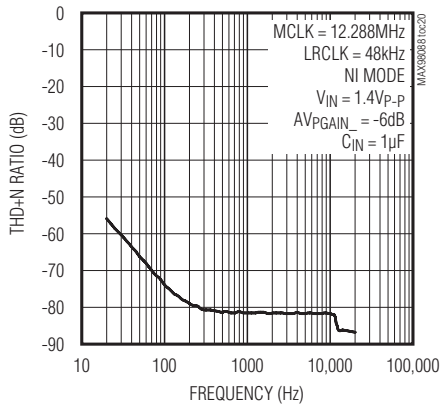

TOTAL HARMONIC DISTORTION PLUS NOISE vs. FREQUENCY (LINE TO ADC)

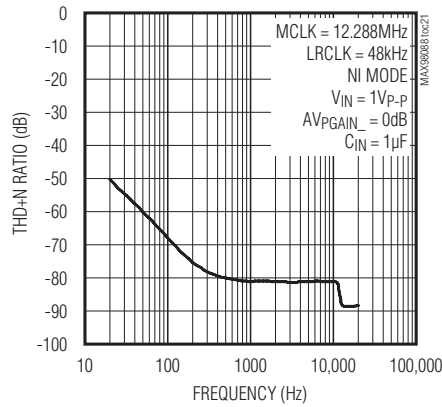

TOTAL HARMONIC DISTORTION PLUS NOISE vs. FREQUENCY (LINE TO ADC)

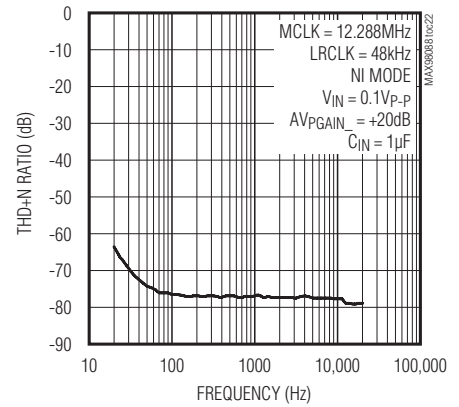

TOTAL HARMONIC DISTORTION PLUS NOISE vs. FREQUENCY (LINE-IN TO ADC)

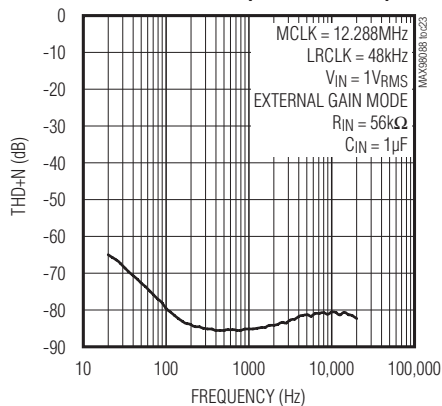

POWER-SUPPLY REJECTION RATIO vs. FREQUENCY (LINE-IN TO ADC)

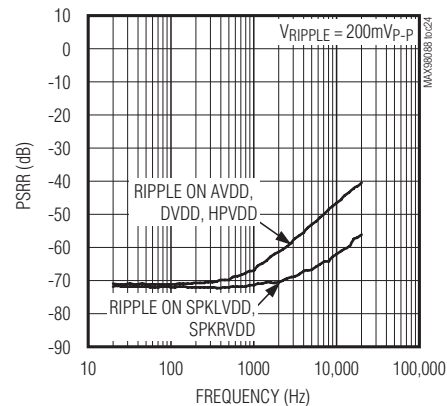

Stereo Audio Codec with FlexSound Technology

Typical Operating Characteristics (continued)

($V_{AVDD} = V_{PVDD} = V_{DVDD} = V_{DVDDS1} = V_{DVDDS2} = +1.8V$, $V_{SPKLVDD} = V_{SPKRVDD} = 3.7V$. Speaker loads (Z_{SPK}) connected between SPK_P and SPK_N. Receiver load (R_{REC}) connected between RECP and REC_N. Headphone loads (R_{HP}) connected from HPL or HPR to HPGND. $R_{HP} = \infty$, $R_{REC} = \infty$, $Z_{SPK} = \infty$, $C_{REF} = 2.2\mu F$, $C_{MICBIAS} = C_{REG} = 1\mu F$, $C_{C1N-C1P} = 1\mu F$, $C_{HPVDD} = C_{HPVSS} = 1\mu F$. $AV_{MICPRE_} = +20dB$, $AV_{MICPGA_} = 0dB$, $AV_{DACATTN} = 0dB$, $AV_{DACGAIN} = 0dB$, $AV_{ADCLVL} = 0dB$, $AV_{ADCGAIN} = 0dB$, $AV_{PGAIN_} = 0dB$, $AV_{HP_} = 0dB$, $AV_{REC} = 0dB$, $AV_{SPK_} = 0dB$, $MCLK = 12.288MHz$, $LRCLK = 48kHz$, $MAS = 1$. $T_A = +25^\circ C$, unless otherwise noted.)

Line-In Pin Direct to ADC

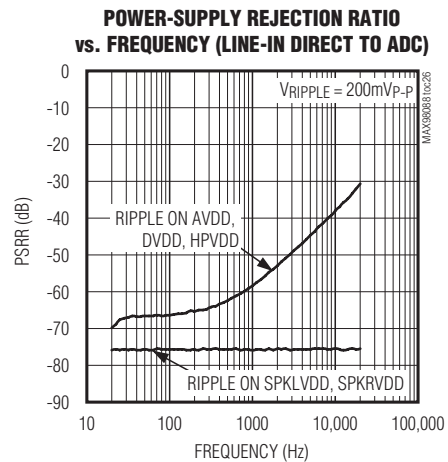
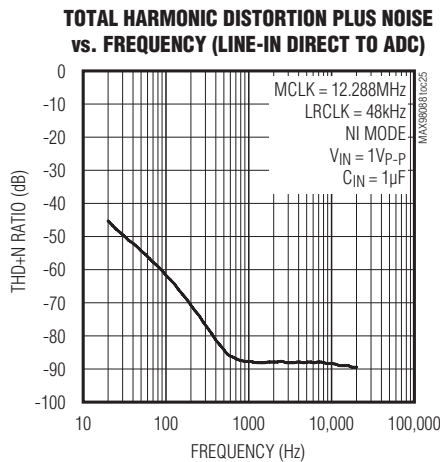

Digital Loopback

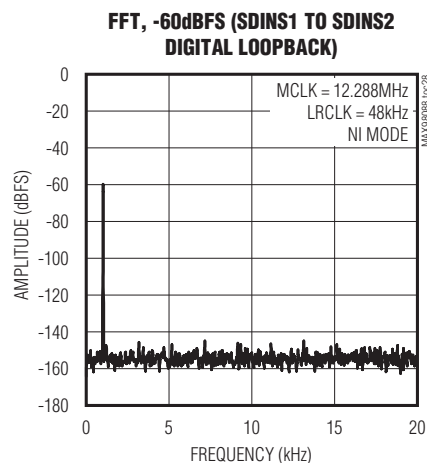
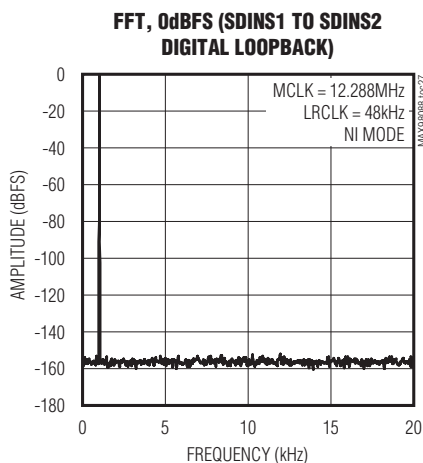

Stereo Audio Codec with FlexSound Technology

Typical Operating Characteristics (continued)

($V_{AVDD} = V_{PVDD} = V_{DVDD} = V_{DVDDS1} = V_{DVDDS2} = +1.8V$, $V_{SPKLVDD} = V_{SPKRVDD} = 3.7V$. Speaker loads (Z_{SPK}) connected between SPK_P and SPK_N. Receiver load (R_{REC}) connected between RECP and RECN. Headphone loads (R_{HP}) connected from HPL or HPR to HPGND. $R_{HP} = \infty$, $R_{REC} = \infty$, $Z_{SPK} = \infty$, $C_{REF} = 2.2\mu F$, $C_{MICBIAS} = C_{REG} = 1\mu F$, $C_{C1N-C1P} = 1\mu F$, $C_{HPVDD} = C_{HPVSS} = 1\mu F$. $AV_{MICPRE_} = +20dB$, $AV_{MICPGA_} = 0dB$, $AV_{DACATTN} = 0dB$, $AV_{DACGAIN} = 0dB$, $AV_{ADCLVL} = 0dB$, $AV_{ADCGAIN} = 0dB$, $AV_{PGAIN_} = 0dB$, $AV_{HP_} = 0dB$, $AV_{REC} = 0dB$, $AV_{SPK_} = 0dB$, $MCLK = 12.288MHz$, $LRCLK = 48kHz$, $MAS = 1$. $T_A = +25^\circ C$, unless otherwise noted.)

Analog Loopback

TOTAL HARMONIC DISTORTION PLUS NOISE vs. FREQUENCY (LINE TO ADC TO DAC TO HEADPHONE)

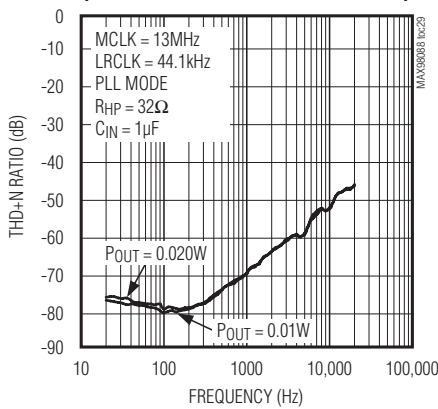

TOTAL HARMONIC DISTORTION PLUS NOISE vs. FREQUENCY (LINE TO ADC TO DAC TO HEADPHONE)

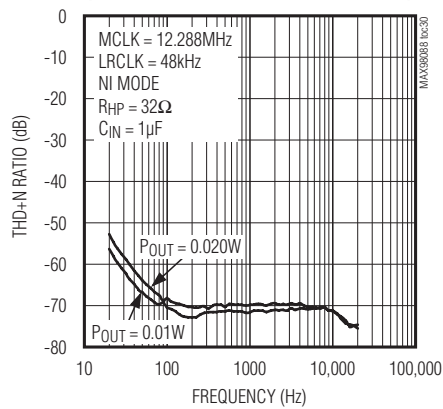

FFT, 0dBFS (LINE TO ADC TO DAC TO HEADPHONE)

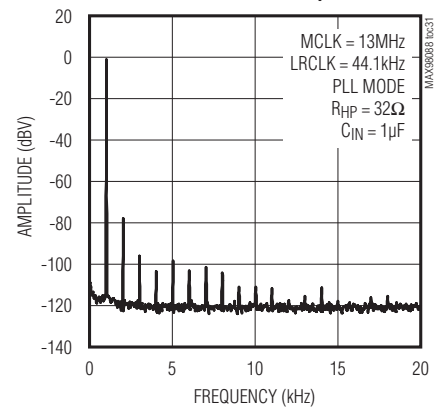

FFT, -60dBFS (LINE TO ADC TO DAC TO HEADPHONE)

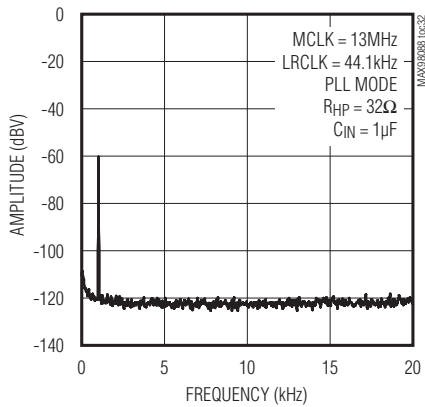

FFT, 0dBFS (LINE TO ADC TO DAC TO HEADPHONE)

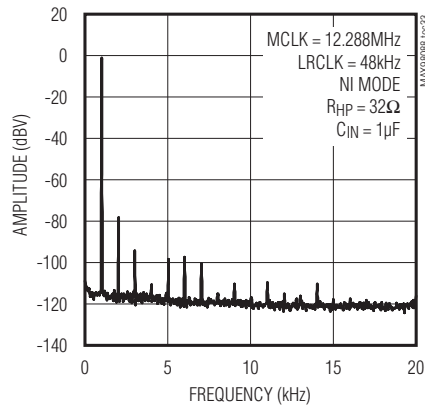

FFT, -60dBFS (LINE TO ADC TO DAC TO HEADPHONE)

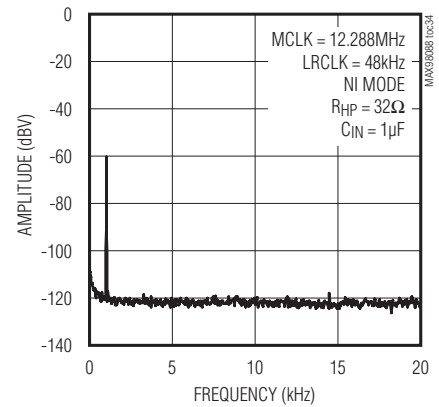

Stereo Audio Codec with FlexSound Technology

Typical Operating Characteristics (continued)

($V_{AVDD} = V_{PVDD} = V_{DVDD} = V_{DVDDS1} = V_{DVDDS2} = +1.8V$, $V_{SPKLVDD} = V_{SPKRVD} = 3.7V$. Speaker loads (Z_{SPK}) connected between SPK_P and SPK_N . Receiver load (R_{REC}) connected between $RECP$ and REC_N . Headphone loads (R_{HP}) connected from HPL or HPR to $HPGND$. $R_{HP} = \infty$, $R_{REC} = \infty$, $Z_{SPK} = \infty$, $C_{REF} = 2.2\mu F$, $C_{MICBIAS} = C_{REG} = 1\mu F$, $C_{C1N-C1P} = 1\mu F$, $C_{HPVDD} = C_{HPVSS} = 1\mu F$. $AV_{MICPRE_} = +20dB$, $AV_{MICPGA_} = 0dB$, $AV_{DACATTN} = 0dB$, $AV_{DACGAIN} = 0dB$, $AV_{ADCLVL} = 0dB$, $AV_{ADCGAIN} = 0dB$, $AV_{PGAIN_} = 0dB$, $AV_{HP_} = 0dB$, $AV_{REC} = 0dB$, $AV_{SPK_} = 0dB$, $MCLK = 12.288MHz$, $LRCLK = 48kHz$, $MAS = 1$. $T_A = +25^\circ C$, unless otherwise noted.)

DAC to Receiver

TOTAL HARMONIC DISTORTION PLUS NOISE vs. OUTPUT POWER (DAC TO RECEIVER)

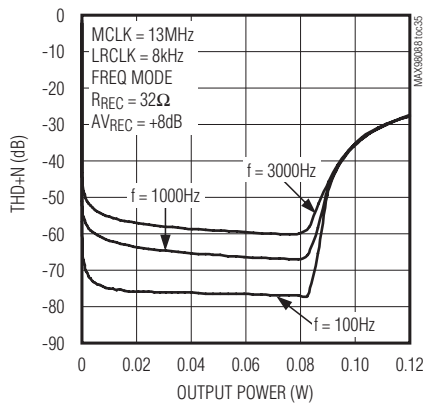

TOTAL HARMONIC DISTORTION PLUS NOISE vs. FREQUENCY (DAC TO RECEIVER)

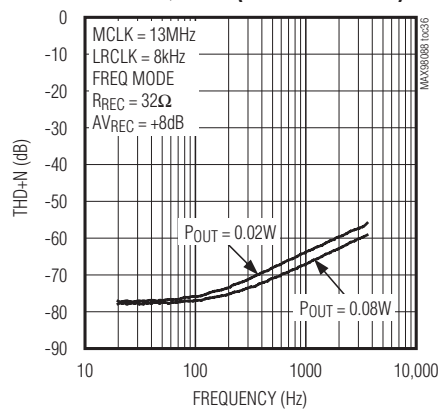

OUTPUT POWER vs. SUPPLY VOLTAGE (DAC TO RECEIVER)

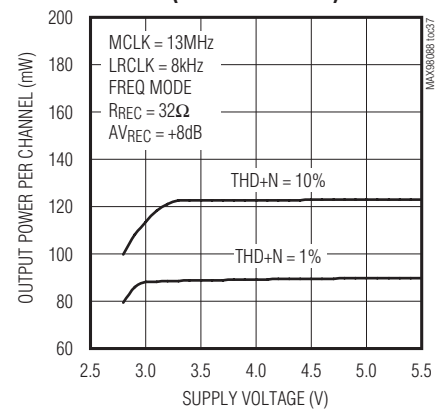

GAIN vs. FREQUENCY (DAC TO RECEIVER)

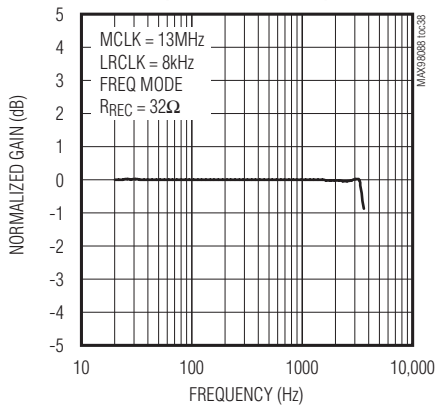

POWER CONSUMPTION vs. OUTPUT POWER (DAC TO RECEIVER)

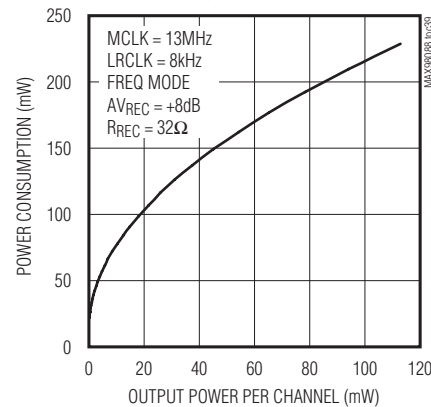

POWER-SUPPLY REJECTION RATIO vs. FREQUENCY (DAC TO RECEIVER)

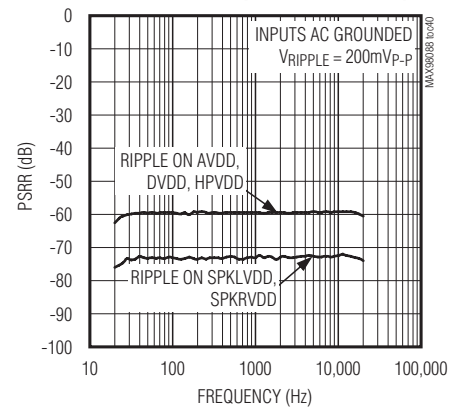

MAX98088

Stereo Audio Codec with FlexSound Technology

Typical Operating Characteristics (continued)

($V_{AVDD} = V_{PVDD} = V_{DVDD} = V_{DVDDS1} = V_{DVDDS2} = +1.8V$, $V_{SPKLVDD} = V_{SPKRVDD} = 3.7V$. Speaker loads (Z_{SPK}) connected between SPK_P and SPK_N. Receiver load (R_{REC}) connected between RECP and RECN. Headphone loads (R_{HP}) connected from HPL or HPR to HPGND. $R_{HP} = \infty$, $R_{REC} = \infty$, $Z_{SPK} = \infty$, $C_{REF} = 2.2\mu F$, $C_{MICBIAS} = C_{REG} = 1\mu F$, $C_{C1N-C1P} = 1\mu F$, $C_{HPVDD} = C_{HPVSS} = 1\mu F$. $AV_{MICPRE_} = +20dB$, $AV_{MICPGA_} = 0dB$, $AV_{DACATTN} = 0dB$, $AV_{DACGAIN} = 0dB$, $AV_{ADCLVL} = 0dB$, $AV_{ADCGAIN} = 0dB$, $AV_{PGAIN_} = 0dB$, $AV_{HP_} = 0dB$, $AV_{REC} = 0dB$, $AV_{SPK_} = 0dB$, $MCLK = 12.288MHz$, $LRCLK = 48kHz$, $MAS = 1$. $T_A = +25^\circ C$, unless otherwise noted.)

**SOFTWARE TURN-ON/OFF RESPONSE
(DAC TO RECEIVER, VSEN = 0)**

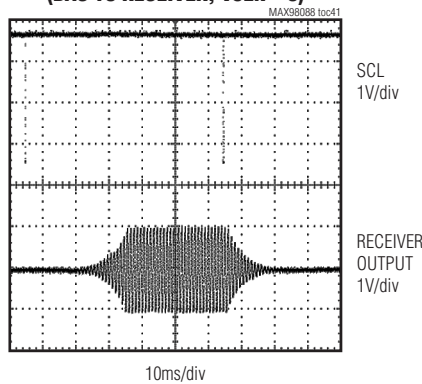

**SOFTWARE TURN-ON/OFF RESPONSE
(DAC TO RECEIVER, VSEN = 1)**

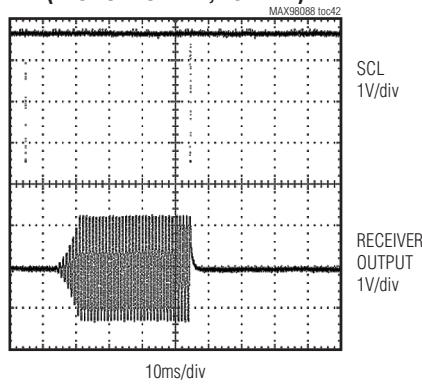

FFT, 0dBFS (DAC TO RECEIVER)

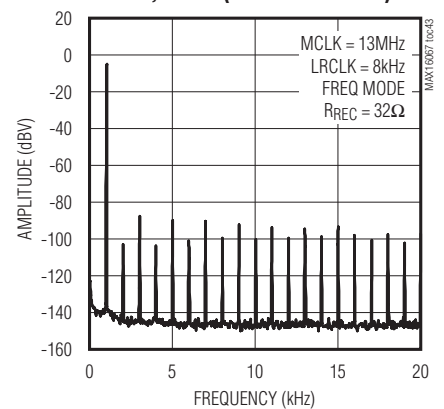

FFT, -60dBFS (DAC TO RECEIVER)

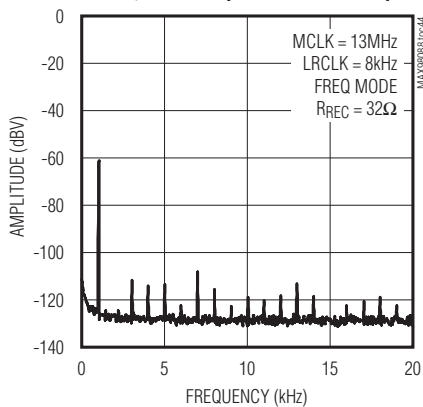

**WIDEBAND FFT, 0dBFS
(DAC TO RECEIVER)**

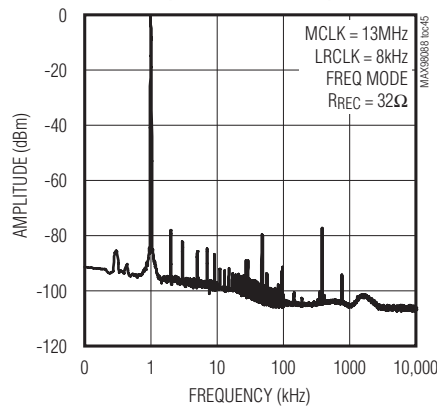

**WIDEBAND FFT, 0dBFS
(DAC TO RECEIVER)**

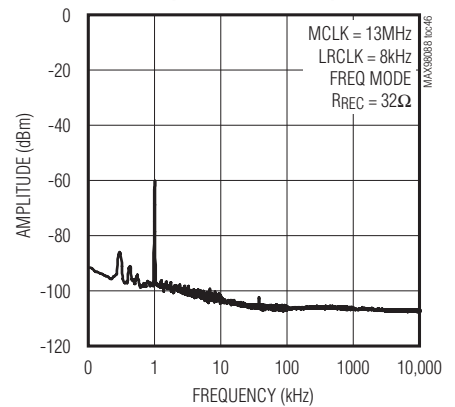

Stereo Audio Codec with FlexSound Technology

Typical Operating Characteristics (continued)

($V_{AVDD} = V_{PVDD} = V_{DVDD} = V_{DVDDS1} = V_{DVDDS2} = +1.8V$, $V_{SPKLVDD} = V_{SPKRVDD} = 3.7V$. Speaker loads (Z_{SPK}) connected between SPK_P and SPK_N. Receiver load (R_{REC}) connected between RECP and RECN. Headphone loads (R_{HP}) connected from HPL or HPR to HPGND. $R_{HP} = \infty$, $R_{REC} = \infty$, $Z_{SPK} = \infty$, $C_{REF} = 2.2\mu F$, $C_{MICBIAS} = C_{REG} = 1\mu F$, $C_{C1N-C1P} = 1\mu F$, $C_{HPVDD} = C_{HPVSS} = 1\mu F$. $AV_{MICPRE_} = +20dB$, $AV_{MICPGA_} = 0dB$, $AV_{DACATTN} = 0dB$, $AV_{DACGAIN} = 0dB$, $AV_{ADCLVL} = 0dB$, $AV_{ADCGAIN} = 0dB$, $AV_{PGAIN_} = 0dB$, $AV_{HP_} = 0dB$, $AV_{REC} = 0dB$, $AV_{SPK_} = 0dB$, $MCLK = 12.288MHz$, $LRCLK = 48kHz$, $MAS = 1$. $T_A = +25^\circ C$, unless otherwise noted.)

Line to Receiver

**TOTAL HARMONIC DISTORTION PLUS NOISE
vs. OUTPUT POWER (LINE TO RECEIVER)**

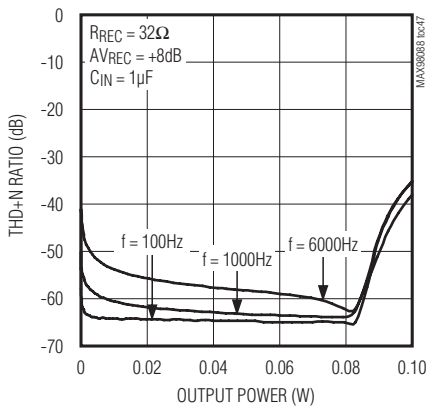

**TOTAL HARMONIC DISTORTION PLUS NOISE
vs. FREQUENCY (LINE TO RECEIVER)**

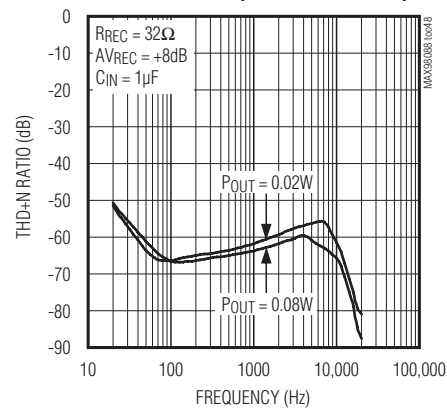

**GAIN vs. FREQUENCY
(LINE TO RECEIVER)**

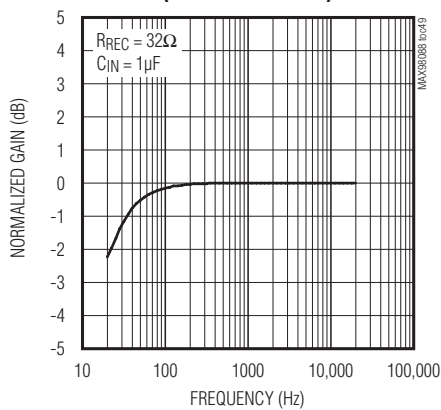

**POWER-SUPPLY
REJECTION RATIO vs. FREQUENCY
(LINE-IN DIRECT TO RECEIVER)**

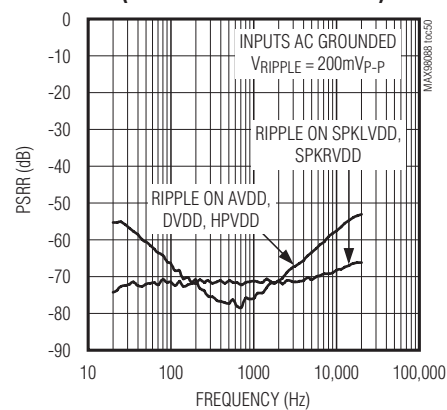

Stereo Audio Codec with FlexSound Technology

Typical Operating Characteristics (continued)

($V_{AVDD} = V_{PVDD} = V_{DVDD} = V_{DVDDS1} = V_{DVDDS2} = +1.8V$, $V_{SPKLVDD} = V_{SPKRVDD} = 3.7V$. Speaker loads (Z_{SPK}) connected between SPK_P and SPK_N. Receiver load (R_{REC}) connected between RECP and RECN. Headphone loads (R_{HP}) connected from HPL or HPR to HPGND. $R_{HP} = \infty$, $R_{REC} = \infty$, $Z_{SPK} = \infty$, $C_{REF} = 2.2\mu F$, $C_{MICBIAS} = C_{REG} = 1\mu F$, $C_{C1N-C1P} = 1\mu F$, $C_{HPVDD} = C_{HPVSS} = 1\mu F$. $AV_{MICPRE_} = +20dB$, $AV_{MICPGA_} = 0dB$, $AV_{DACATTN} = 0dB$, $AV_{DACGAIN} = 0dB$, $AV_{ADCLVL} = 0dB$, $AV_{ADCGAIN} = 0dB$, $AV_{PGAIN_} = 0dB$, $AV_{HP_} = 0dB$, $AV_{REC} = 0dB$, $AV_{SPK_} = 0dB$, $MCLK = 12.288MHz$, $LRCLK = 48kHz$, $MAS = 1$. $T_A = +25^\circ C$, unless otherwise noted.)

DAC to Line Output

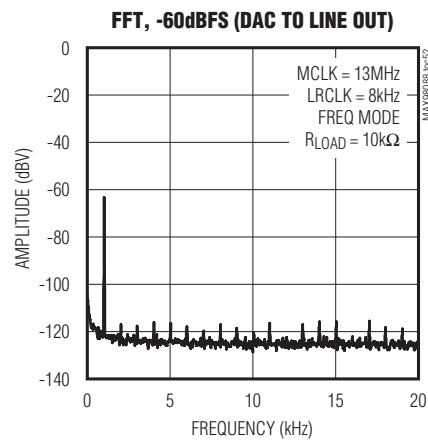
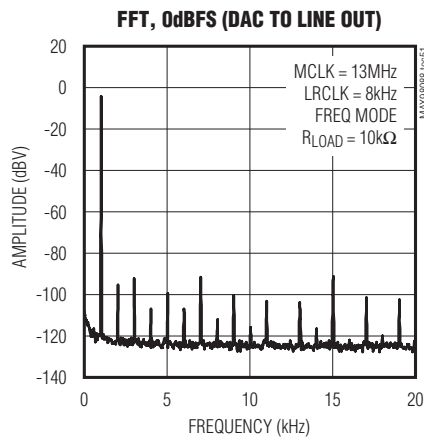

Line to Line Output

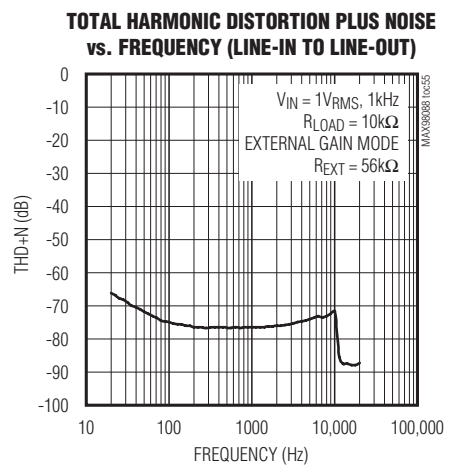
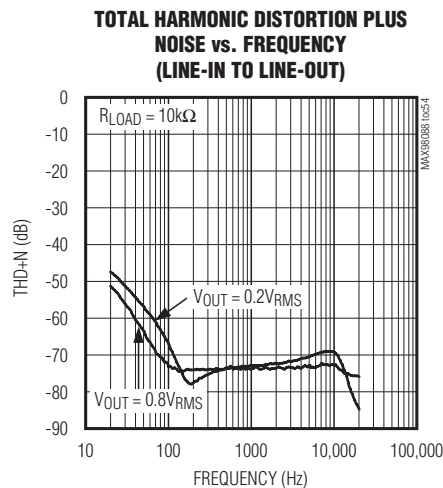
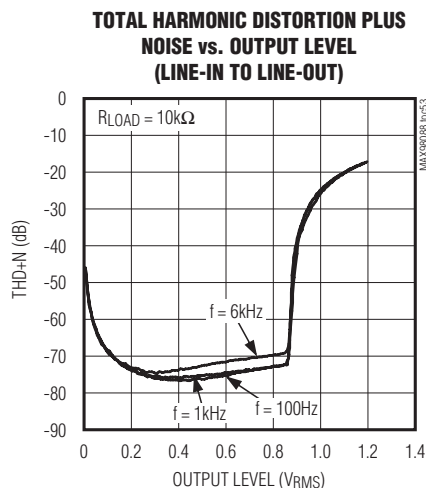

Stereo Audio Codec with FlexSound Technology

Typical Operating Characteristics (continued)

($V_{AVDD} = V_{PVDD} = V_{DVDD} = V_{DVDDS1} = V_{DVDDS2} = +1.8V$, $V_{SPKLVDD} = V_{SPKRVDD} = 3.7V$. Speaker loads (Z_{SPK}) connected between SPK_P and SPK_N. Receiver load (R_{REC}) connected between RECP and RECN. Headphone loads (R_{HP}) connected from HPL or HPR to HPGND. $R_{HP} = \infty$, $R_{REC} = \infty$, $Z_{SPK} = \infty$, $C_{REF} = 2.2\mu F$, $C_{MICBIAS} = C_{REG} = 1\mu F$, $C_{C1N-C1P} = 1\mu F$, $C_{HPVDD} = C_{HPVSS} = 1\mu F$. $AV_{MICPRE_} = +20dB$, $AV_{MICPGA_} = 0dB$, $AV_{DACATTN} = 0dB$, $AV_{DACGAIN} = 0dB$, $AV_{ADCLVL} = 0dB$, $AV_{ADCGAIN} = 0dB$, $AV_{PGAIN_} = 0dB$, $AV_{HP_} = 0dB$, $AV_{REC} = 0dB$, $AV_{SPK_} = 0dB$, $MCLK = 12.288MHz$, $LRCLK = 48kHz$, $MAS = 1$. $T_A = +25^\circ C$, unless otherwise noted.)

DAC to Speaker

TOTAL HARMONIC DISTORTION PLUS NOISE vs. OUTPUT POWER (DAC TO SPEAKER)

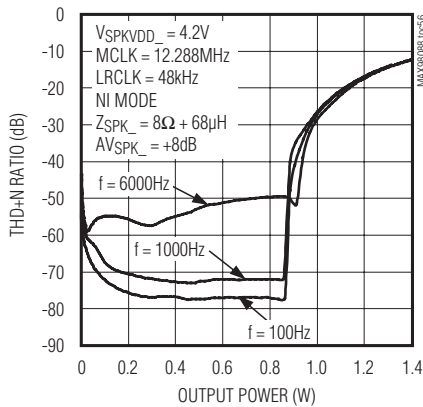

TOTAL HARMONIC DISTORTION PLUS NOISE vs. OUTPUT POWER (DAC TO SPEAKER)

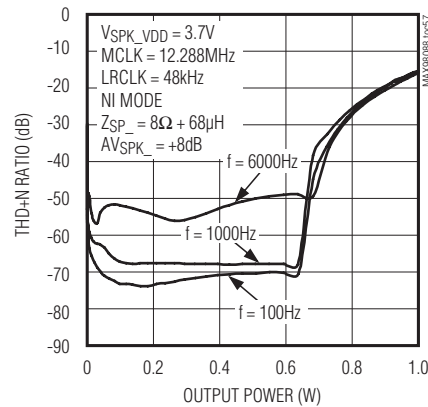

TOTAL HARMONIC DISTORTION PLUS NOISE vs. OUTPUT POWER (DAC TO SPEAKER)

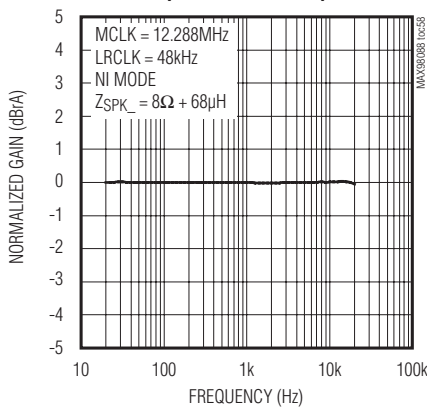

TOTAL HARMONIC DISTORTION PLUS NOISE vs. OUTPUT POWER (DAC TO SPEAKER)

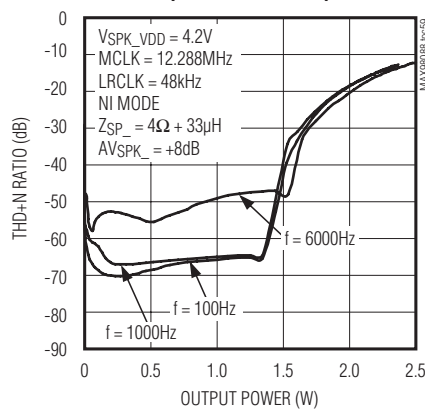

TOTAL HARMONIC DISTORTION PLUS NOISE vs. OUTPUT POWER (DAC TO SPEAKER)

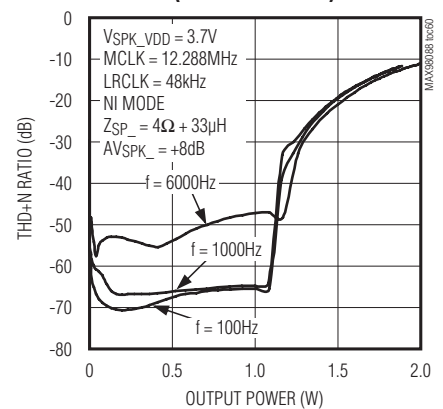

Stereo Audio Codec with FlexSound Technology

Typical Operating Characteristics (continued)

($V_{AVDD} = V_{PVDD} = V_{DVDD} = V_{DVDDS1} = V_{DVDDS2} = +1.8V$, $V_{SPKLVDD} = V_{SPKRVDD} = 3.7V$. Speaker loads (Z_{SPK}) connected between SPK_P and SPK_N . Receiver load (R_{REC}) connected between $RECP$ and $RECN$. Headphone loads (R_{HP}) connected from HPL or HPR to $HPGND$. $R_{HP} = \infty$, $R_{REC} = \infty$, $Z_{SPK} = \infty$, $C_{REF} = 2.2\mu F$, $C_{MICBIAS} = C_{REG} = 1\mu F$, $C_{C1N-C1P} = 1\mu F$, $C_{HPVDD} = C_{HPVSS} = 1\mu F$. $AV_{MICPRE_} = +20dB$, $AV_{MICPGA_} = 0dB$, $AV_{DACATTN} = 0dB$, $AV_{DACGAIN} = 0dB$, $AV_{ADCLVL} = 0dB$, $AV_{ADCGAIN} = 0dB$, $AV_{PGAIN_} = 0dB$, $AV_{HP_} = 0dB$, $AV_{REC} = 0dB$, $AV_{SPK_} = 0dB$, $MCLK = 12.288MHz$, $LRCLK = 48kHz$, $MAS = 1$. $T_A = +25^\circ C$, unless otherwise noted.)

TOTAL HARMONIC DISTORTION PLUS NOISE vs. OUTPUT POWER (DAC TO SPEAKER)

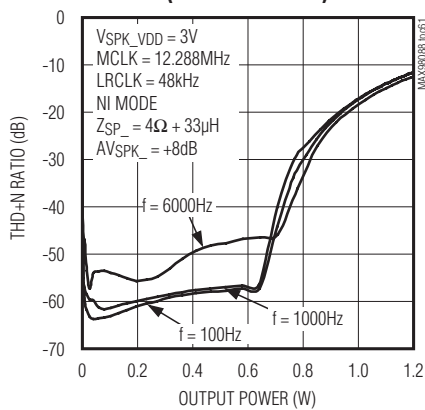

TOTAL HARMONIC DISTORTION PLUS NOISE vs. FREQUENCY (DAC TO SPEAKER)

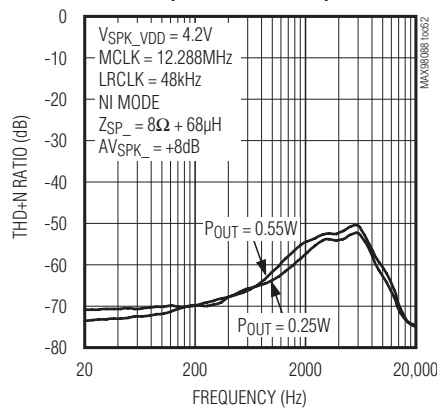

TOTAL HARMONIC DISTORTION PLUS NOISE vs. FREQUENCY (DAC TO SPEAKER)

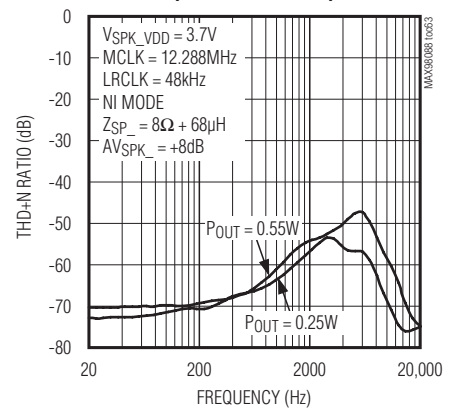

TOTAL HARMONIC DISTORTION PLUS NOISE vs. FREQUENCY (DAC TO SPEAKER)

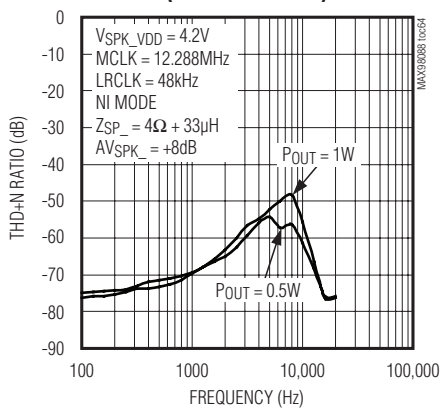

TOTAL HARMONIC DISTORTION PLUS NOISE vs. FREQUENCY (DAC TO SPEAKER)

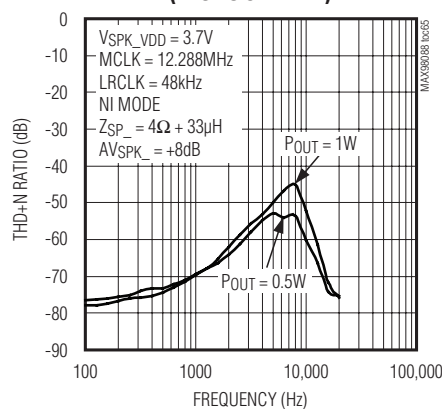

OUTPUT POWER vs. SUPPLY VOLTAGE (DAC TO SPEAKER)

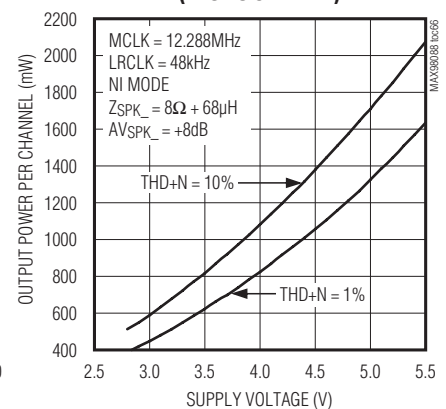

Stereo Audio Codec with FlexSound Technology

Typical Operating Characteristics (continued)

($V_{AVDD} = V_{PVDD} = V_{DVDD} = V_{DVDDS1} = V_{DVDDS2} = +1.8V$, $V_{SPKLVDD} = V_{SPKRVDD} = 3.7V$. Speaker loads (Z_{SPK}) connected between SPK_P and SPK_N . Receiver load (R_{REC}) connected between $RECP$ and $RECN$. Headphone loads (R_{HP}) connected between HPL or HPR to $HPGND$. $R_{HP} = \infty$, $R_{REC} = \infty$, $Z_{SPK} = \infty$, $C_{REF} = 2.2\mu F$, $C_{MICBIAS} = C_{REG} = 1\mu F$, $C_{C1N-C1P} = 1\mu F$, $C_{HPVDD} = C_{HPVSS} = 1\mu F$. $AV_{MICPRE_} = +20dB$, $AV_{MICPGA_} = 0dB$, $AV_{DACATTN} = 0dB$, $AV_{DACGAIN} = 0dB$, $AV_{ADCLVL} = 0dB$, $AV_{ADCGAIN} = 0dB$, $AV_{PGAIN_} = 0dB$, $AV_{HP_} = 0dB$, $AV_{REC} = 0dB$, $AV_{SPK_} = 0dB$, $MCLK = 12.288MHz$, $LRCLK = 48kHz$, $MAS = 1$. $T_A = +25^\circ C$, unless otherwise noted.)

**OUTPUT POWER vs. SUPPLY VOLTAGE
(DAC TO SPEAKER)**

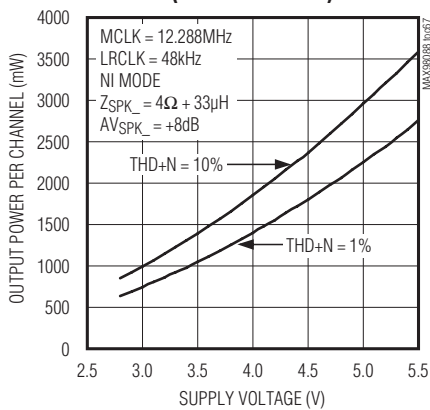

**GAIN vs. FREQUENCY
(DAC TO SPEAKER)**

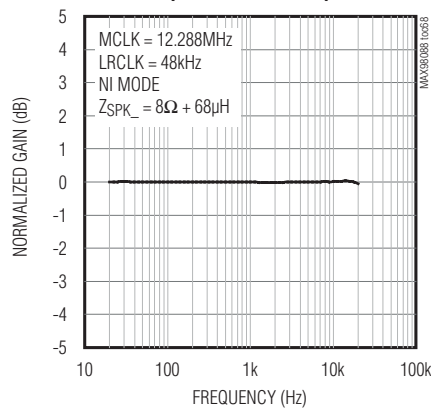

**EFFICIENCY vs. OUTPUT POWER
(DAC TO SPEAKER)**

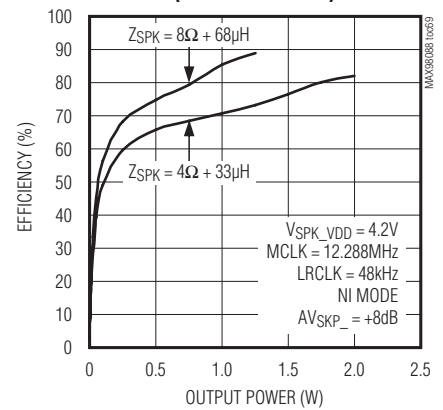

**EFFICIENCY vs. OUTPUT POWER
(DAC TO SPEAKER)**

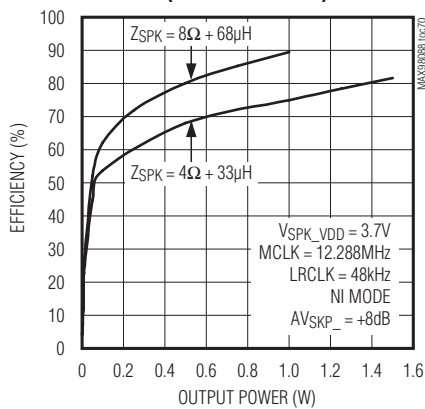

**SUPPLY CURRENT vs. SUPPLY VOLTAGE
(DAC TO SPEAKER)**

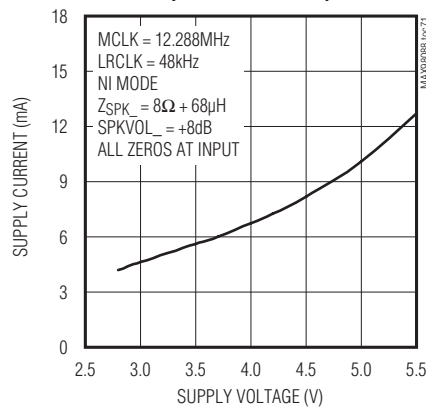

**POWER-SUPPLY REJECTION RATIO
vs. FREQUENCY (DAC TO SPEAKER)**

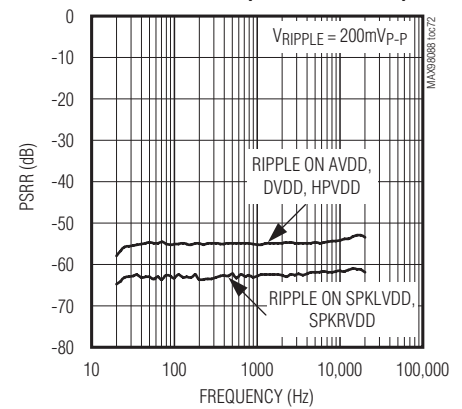

MAX98088

Stereo Audio Codec with FlexSound Technology

Typical Operating Characteristics (continued)

($V_{AVDD} = V_{PVDD} = V_{DVDD} = V_{DVDDS1} = V_{DVDDS2} = +1.8V$, $V_{SPKLVDD} = V_{SPKRVDD} = 3.7V$. Speaker loads (Z_{SPK}) connected between SPK_P and SPK_N. Receiver load (R_{REC}) connected between RECP and RECN. Headphone loads (R_{HP}) connected from HPL or HPR to HPGND. $R_{HP} = \infty$, $R_{REC} = \infty$, $Z_{SPK} = \infty$, $C_{REF} = 2.2\mu F$, $C_{MICBIAS} = C_{REG} = 1\mu F$, $C_{C1N-C1P} = 1\mu F$, $C_{HPVDD} = C_{HPVSS} = 1\mu F$. $AV_{MICPRE_} = +20dB$, $AV_{MICPGA_} = 0dB$, $AV_{DACATTN} = 0dB$, $AV_{DACGAIN} = 0dB$, $AV_{ADCLVL} = 0dB$, $AV_{ADCGAIN} = 0dB$, $AV_{PGAIN_} = 0dB$, $AV_{HP_} = 0dB$, $AV_{REC} = 0dB$, $AV_{SPK_} = 0dB$, $MCLK = 12.288MHz$, $LRCLK = 48kHz$, $MAS = 1$. $T_A = +25^\circ C$, unless otherwise noted.)

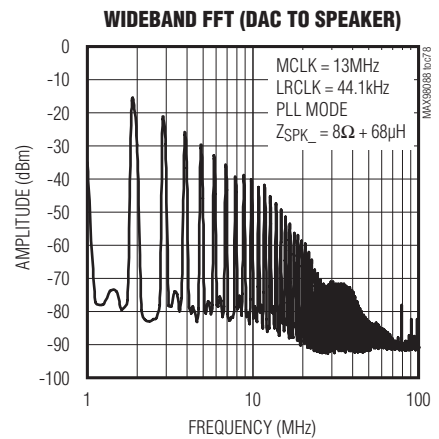
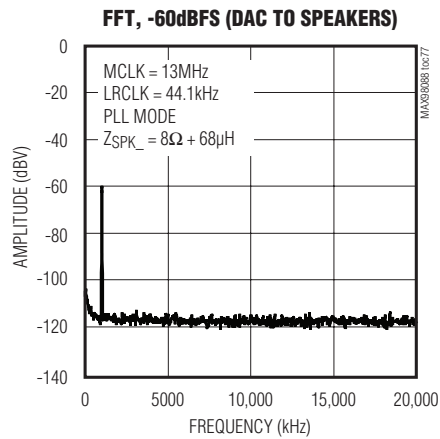
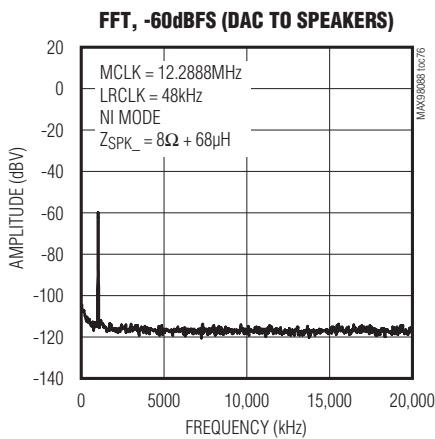
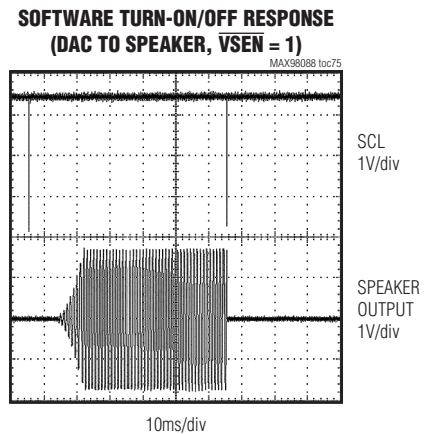
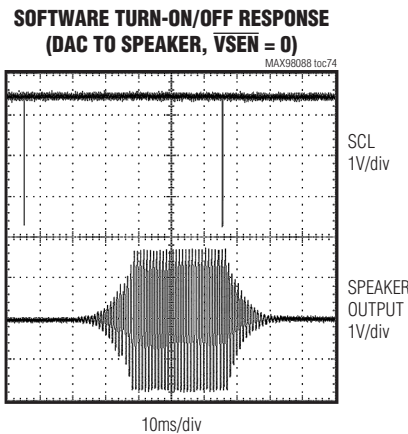
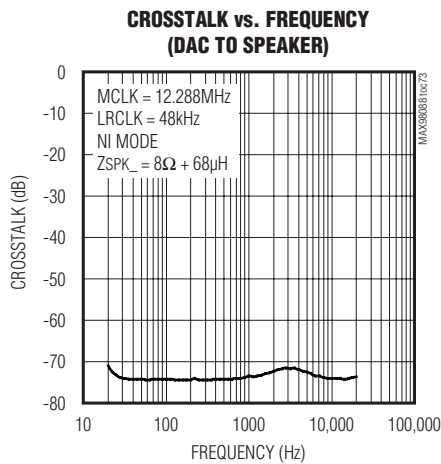

MAX98088

Stereo Audio Codec with FlexSound Technology

Typical Operating Characteristics (continued)

($V_{AVDD} = V_{PVDD} = V_{DVDD} = V_{DVDDS1} = V_{DVDDS2} = +1.8V$, $V_{SPKLVDD} = V_{SPKRVDD} = 3.7V$. Speaker loads (Z_{SPK}) connected between SPK_P and SPK_N. Receiver load (R_{REC}) connected between RECP and REC_N. Headphone loads (R_{HP}) connected from HPL or HPR to HPGND. $R_{HP} = \infty$, $R_{REC} = \infty$, $Z_{SPK} = \infty$, $C_{REF} = 2.2\mu F$, $C_{MICBIAS} = C_{REG} = 1\mu F$, $C_{C1N-C1P} = 1\mu F$, $C_{HPVDD} = C_{HPVSS} = 1\mu F$. $AV_{MICPRE_} = +20dB$, $AV_{MICPGA_} = 0dB$, $AV_{DACATTN} = 0dB$, $AV_{DACGAIN} = 0dB$, $AV_{ADCLVL} = 0dB$, $AV_{ADCGAIN} = 0dB$, $AV_{PGAIN_} = 0dB$, $AV_{HP_} = 0dB$, $AV_{REC} = 0dB$, $AV_{SPK_} = 0dB$, $MCLK = 12.288MHz$, $LRCLK = 48kHz$, $MAS = 1$. $T_A = +25^\circ C$, unless otherwise noted.)

Line to Speaker

TOTAL HARMONIC DISTORTION PLUS NOISE vs. OUTPUT POWER (LINE TO SPEAKER)

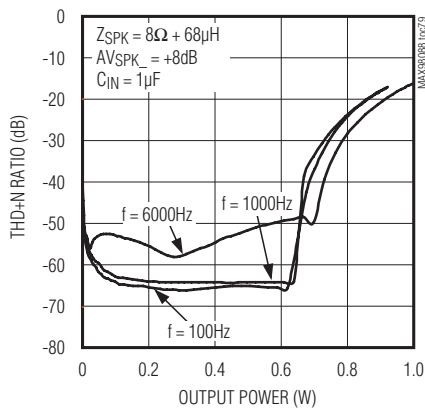

TOTAL HARMONIC DISTORTION PLUS NOISE vs. FREQUENCY (LINE TO SPEAKER)

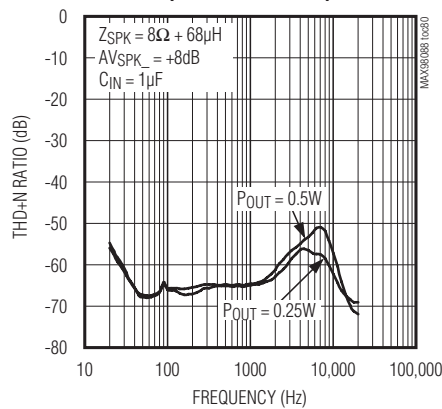

GAIN vs. FREQUENCY (LINE TO SPEAKER)

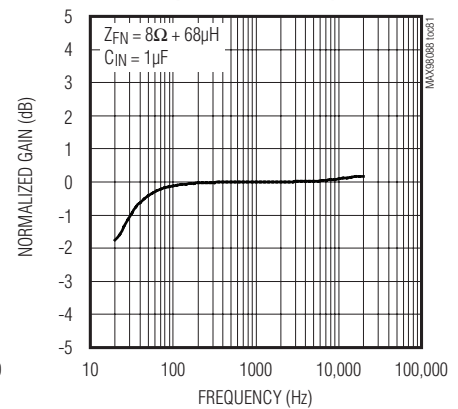

POWER-SUPPLY REJECTION RATIO vs. FREQUENCY (LINE-IN TO SPEAKER)

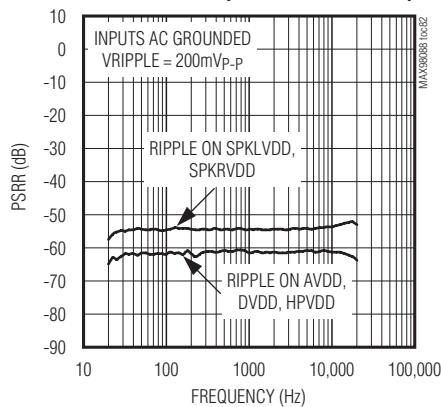

CROSSTALK vs. FREQUENCY (LINE TO SPEAKER)

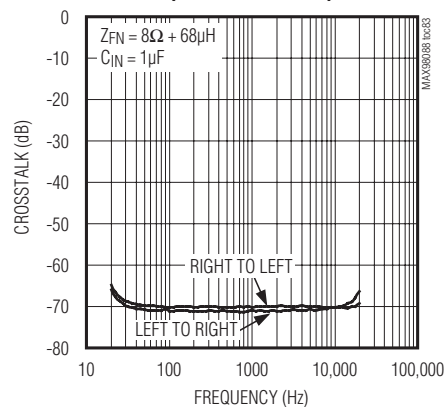

Stereo Audio Codec with FlexSound Technology

Typical Operating Characteristics (continued)

($V_{AVDD} = V_{PVDD} = V_{DVDD} = V_{DVDDS1} = V_{DVDDS2} = +1.8V$, $V_{SPKLVDD} = V_{SPKRVDD} = 3.7V$. Speaker loads (Z_{SPK}) connected between SPK_P and SPK_N. Receiver load (R_{REC}) connected between RECP and RECN. Headphone loads (R_{HP}) connected from HPL or HPR to HPGND. $R_{HP} = \infty$, $R_{REC} = \infty$, $Z_{SPK} = \infty$, $C_{REF} = 2.2\mu F$, $C_{MICBIAS} = C_{REG} = 1\mu F$, $C_{C1N-C1P} = 1\mu F$, $C_{HPVDD} = C_{HPVSS} = 1\mu F$. $AV_{MICPRE_} = +20dB$, $AV_{MICPGA_} = 0dB$, $AV_{DACATTN} = 0dB$, $AV_{DACGAIN} = 0dB$, $AV_{ADCLVL} = 0dB$, $AV_{ADCGAIN} = 0dB$, $AV_{PGAIN_} = 0dB$, $AV_{HP_} = 0dB$, $AV_{REC} = 0dB$, $AV_{SPK_} = 0dB$, $MCLK = 12.288MHz$, $LRCLK = 48kHz$, $MAS = 1$. $T_A = +25^\circ C$, unless otherwise noted.)

DAC to Headphone

TOTAL HARMONIC DISTORTION PLUS NOISE vs. OUTPUT POWER (DAC TO HEADPHONE)

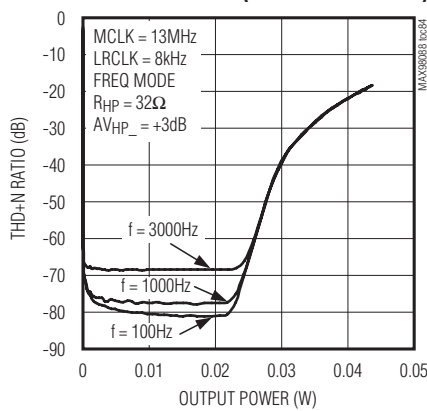

TOTAL HARMONIC DISTORTION PLUS NOISE vs. OUTPUT POWER (DAC TO HEADPHONE)

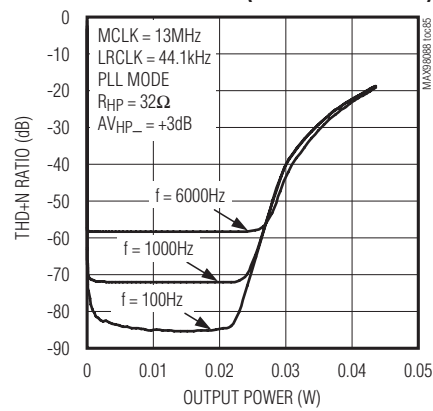

TOTAL HARMONIC DISTORTION PLUS NOISE vs. OUTPUT POWER (DAC TO HEADPHONE)

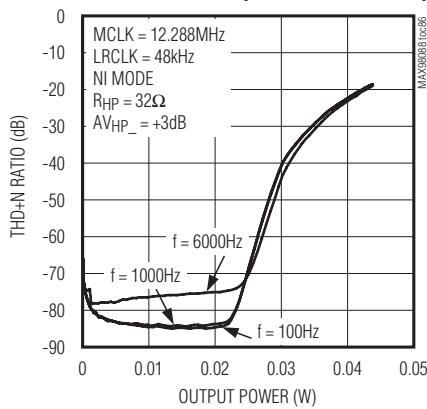

TOTAL HARMONIC DISTORTION PLUS NOISE vs. OUTPUT POWER (DAC TO HEADPHONE)

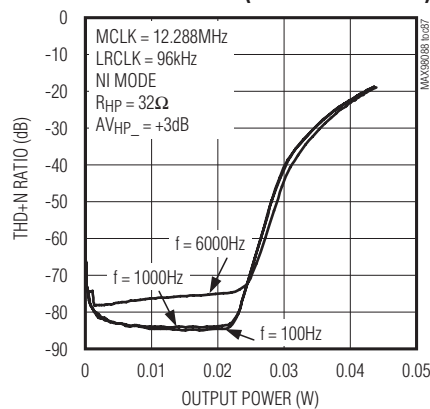

TOTAL HARMONIC DISTORTION PLUS NOISE vs. OUTPUT POWER (DAC TO HEADPHONE)

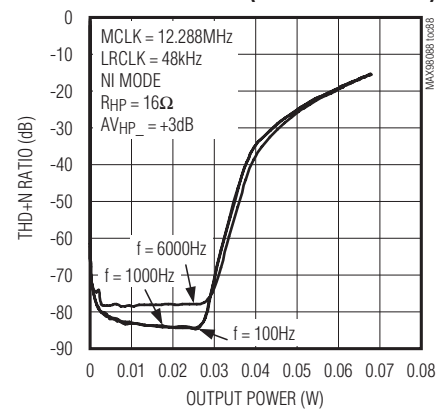

Stereo Audio Codec with FlexSound Technology

Typical Operating Characteristics (continued)

($V_{AVDD} = V_{PVDD} = V_{DVDD} = V_{DVDDS1} = V_{DVDDS2} = +1.8V$, $V_{SPKLVDD} = V_{SPKRVDD} = 3.7V$. Speaker loads (Z_{SPK}) connected between SPK_P and SPK_N. Receiver load (R_{REC}) connected between RECP and RECN. Headphone loads (R_{HP}) connected from HPL or HPR to HPGND. $R_{HP} = \infty$, $R_{REC} = \infty$, $Z_{SPK} = \infty$, $C_{REF} = 2.2\mu F$, $C_{MICBIAS} = C_{REG} = 1\mu F$, $C_{C1N-C1P} = 1\mu F$, $C_{HPVDD} = C_{HPVSS} = 1\mu F$. $AV_{MICPRE_} = +20dB$, $AV_{MICPGA_} = 0dB$, $AV_{DACATTN} = 0dB$, $AV_{DACGAIN} = 0dB$, $AV_{ADCLVL} = 0dB$, $AV_{ADCGAIN} = 0dB$, $AV_{PGAIN_} = 0dB$, $AV_{HP_} = 0dB$, $AV_{REC} = 0dB$, $AV_{SPK_} = 0dB$, $MCLK = 12.288MHz$, $LRCLK = 48kHz$, $MAS = 1$. $T_A = +25^\circ C$, unless otherwise noted.)

TOTAL HARMONIC DISTORTION PLUS NOISE vs. OUTPUT POWER (DAC TO HEADPHONE)

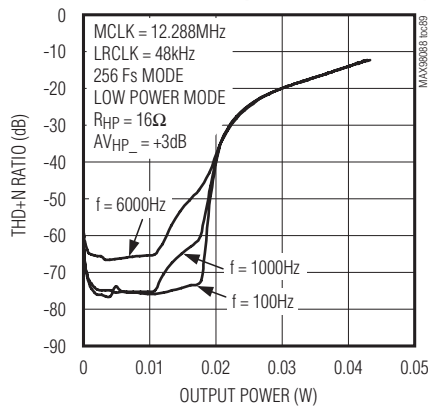

TOTAL HARMONIC DISTORTION PLUS NOISE vs. OUTPUT POWER (DAC TO HEADPHONE)

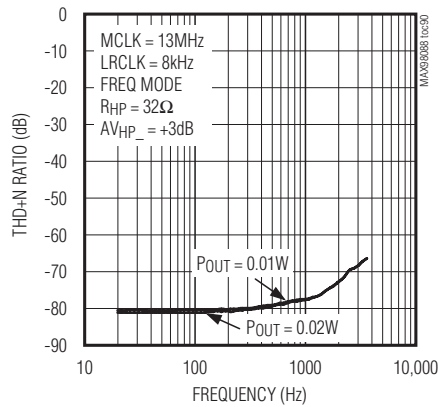

TOTAL HARMONIC DISTORTION PLUS NOISE vs. FREQUENCY (DAC TO HEADPHONE)

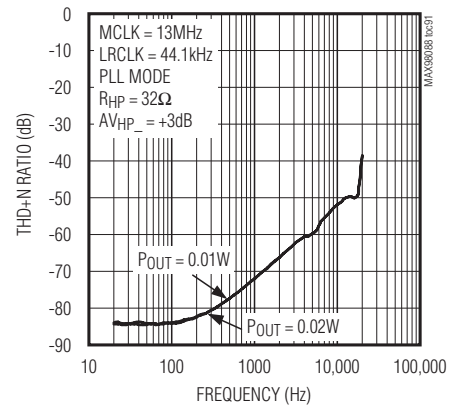

TOTAL HARMONIC DISTORTION PLUS NOISE vs. FREQUENCY (DAC TO HEADPHONE)

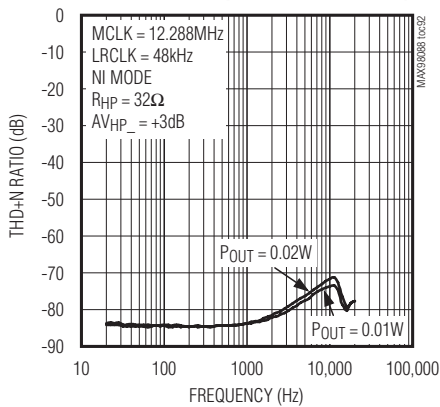

TOTAL HARMONIC DISTORTION PLUS NOISE vs. FREQUENCY (DAC TO HEADPHONE)

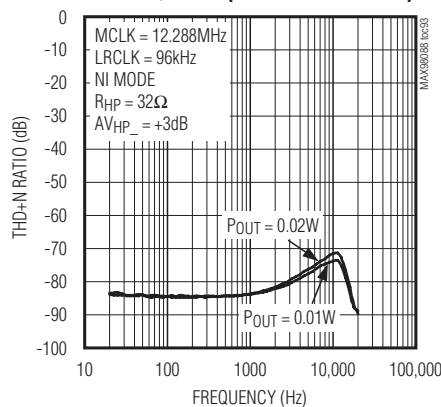

TOTAL HARMONIC DISTORTION PLUS NOISE vs. FREQUENCY (DAC TO HEADPHONE)

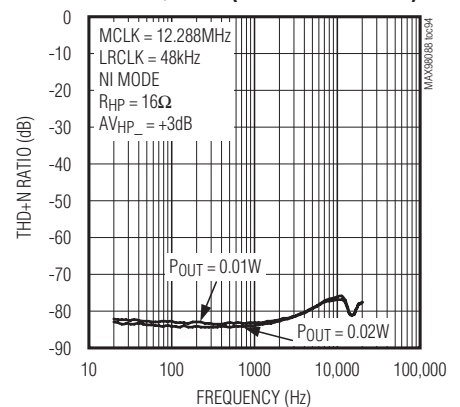

MAX98088

Stereo Audio Codec with FlexSound Technology

Typical Operating Characteristics (continued)

($V_{AVDD} = V_{PVDD} = V_{DVDD} = V_{DVDDS1} = V_{DVDDS2} = +1.8V$, $V_{SPKLVDD} = V_{SPKRVDD} = 3.7V$. Speaker loads (Z_{SPK}) connected between SPK_P and SPK_N. Receiver load (R_{REC}) connected between RECP and RECN. Headphone loads (R_{HP}) connected from HPL or HPR to HPGND. $R_{HP} = \infty$, $R_{REC} = \infty$, $Z_{SPK} = \infty$, $C_{REF} = 2.2\mu F$, $C_{MICBIAS} = C_{REG} = 1\mu F$, $C_{C1N-C1P} = 1\mu F$, $C_{HPVDD} = C_{HPVSS} = 1\mu F$. $AV_{MICPRE_} = +20dB$, $AV_{MICPGA_} = 0dB$, $AV_{DACATTN} = 0dB$, $AV_{DACGAIN} = 0dB$, $AV_{ADCLVL} = 0dB$, $AV_{ADCGAIN} = 0dB$, $AV_{PGAIN_} = 0dB$, $AV_{HP_} = 0dB$, $AV_{REC} = 0dB$, $AV_{SPK_} = 0dB$, $MCLK = 12.288MHz$, $LRCLK = 48kHz$, $MAS = 1$. $T_A = +25^\circ C$, unless otherwise noted.)

**GAIN vs. FREQUENCY
(DAC TO HEADPHONE)**

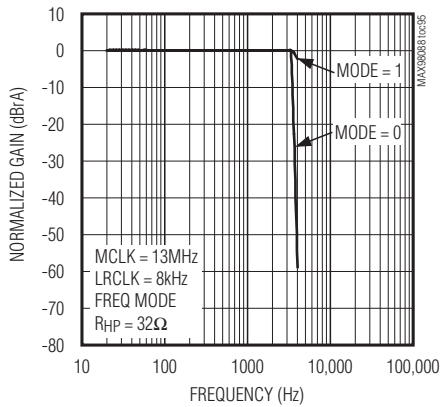

**PVDD CURRENT vs. OUTPUT POWER
(DAC TO HEADPHONE)**

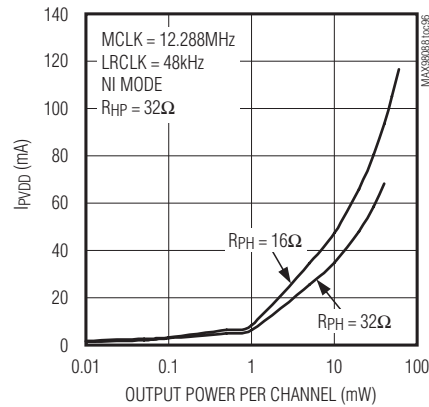

**PVDD CURRENT vs. OUTPUT POWER
(DAC TO HEADPHONE)**

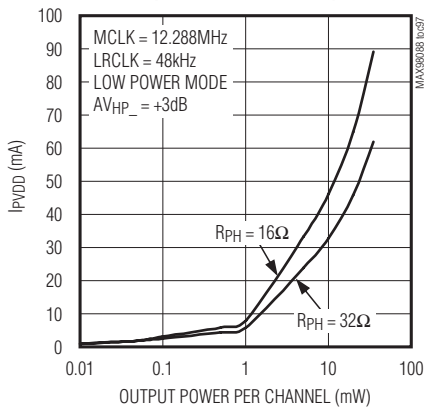

**POWER-SUPPLY REJECTION RATIO
vs. FREQUENCY (DAC TO HEADPHONE)**

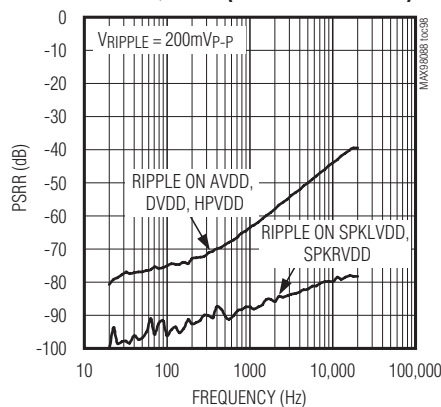

**POWER-SUPPLY REJECTION RATIO
vs. FREQUENCY (DAC TO HEADPHONE)**

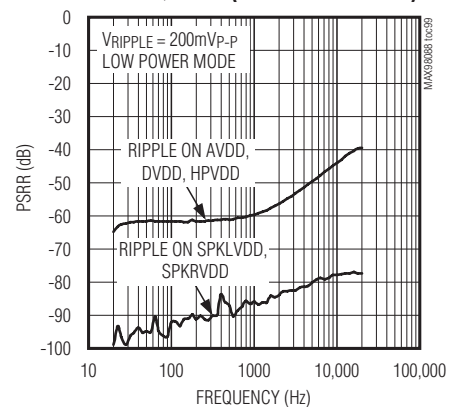

MAX98088

Stereo Audio Codec with FlexSound Technology

Typical Operating Characteristics (continued)

($V_{AVDD} = V_{PVDD} = V_{DVDD} = V_{DVDDS1} = V_{DVDDS2} = +1.8V$, $V_{SPKLVDD} = V_{SPKRVDD} = 3.7V$. Speaker loads (Z_{SPK}) connected between SPK_P and SPK_N. Receiver load (R_{REC}) connected between RECP and RECN. Headphone loads (R_{HP}) connected from HPL or HPR to HPGND. $R_{HP} = \infty$, $R_{REC} = \infty$, $Z_{SPK} = \infty$, $C_{REF} = 2.2\mu F$, $C_{MICBIAS} = C_{REG} = 1\mu F$, $C_{C1N-C1P} = 1\mu F$, $C_{HPVDD} = C_{HPVSS} = 1\mu F$. $AV_{MICPRE_} = +20dB$, $AV_{MICPGA_} = 0dB$, $AV_{DACATTN} = 0dB$, $AV_{DACGAIN} = 0dB$, $AV_{ADCLVL} = 0dB$, $AV_{ADCGAIN} = 0dB$, $AV_{PGAIN_} = 0dB$, $AV_{HP_} = 0dB$, $AV_{REC} = 0dB$, $AV_{SPK_} = 0dB$, $MCLK = 12.288MHz$, $LRCLK = 48kHz$, $MAS = 1$. $T_A = +25^\circ C$, unless otherwise noted.)

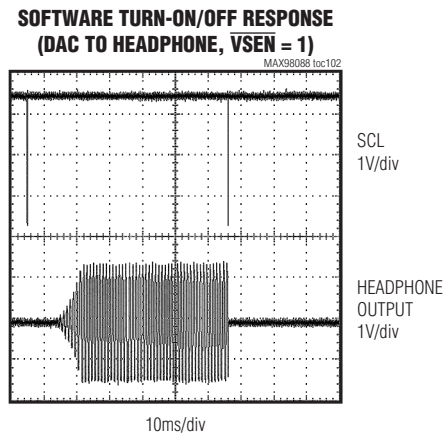
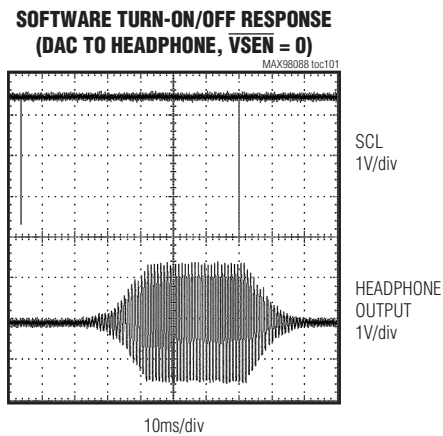
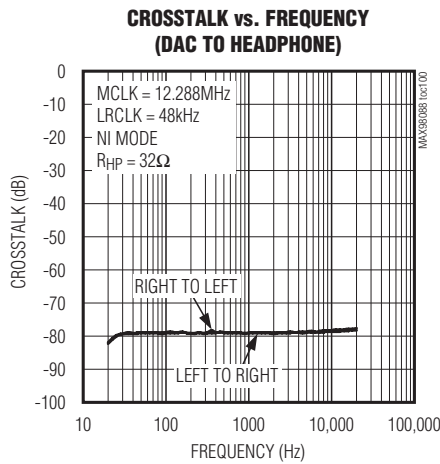

MAX98088

Stereo Audio Codec with FlexSound Technology

Typical Operating Characteristics (continued)

($V_{AVDD} = V_{PVDD} = V_{DVDD} = V_{DVDDS1} = V_{DVDDS2} = +1.8V$, $V_{SPKLVDD} = V_{SPKRVDD} = 3.7V$. Speaker loads (Z_{SPK}) connected between SPK_P and SPK_N. Receiver load (R_{REC}) connected between RECP and RECN. Headphone loads (R_{HP}) connected from HPL or HPR to HPGND. $R_{HP} = \infty$, $R_{REC} = \infty$, $Z_{SPK} = \infty$, $C_{REF} = 2.2\mu F$, $C_{MICBIAS} = C_{REG} = 1\mu F$, $C_{C1N-C1P} = 1\mu F$, $C_{HPVDD} = C_{HPVSS} = 1\mu F$. $AV_{MICPRE_} = +20dB$, $AV_{MICPGA_} = 0dB$, $AV_{DACATTN} = 0dB$, $AV_{DACGAIN} = 0dB$, $AV_{ADCLVL} = 0dB$, $AV_{ADCGAIN} = 0dB$, $AV_{PGAIN_} = 0dB$, $AV_{HP_} = 0dB$, $AV_{REC} = 0dB$, $AV_{SPK_} = 0dB$, $MCLK = 12.288MHz$, $LRCLK = 48kHz$, $MAS = 1$. $T_A = +25^\circ C$, unless otherwise noted.)

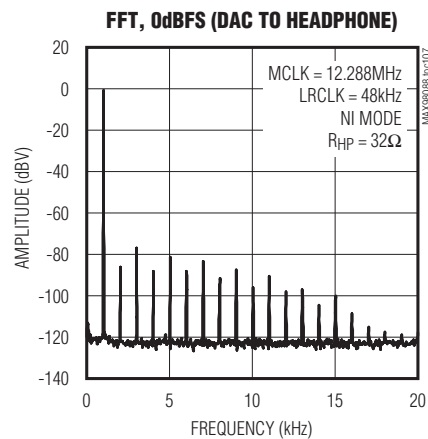
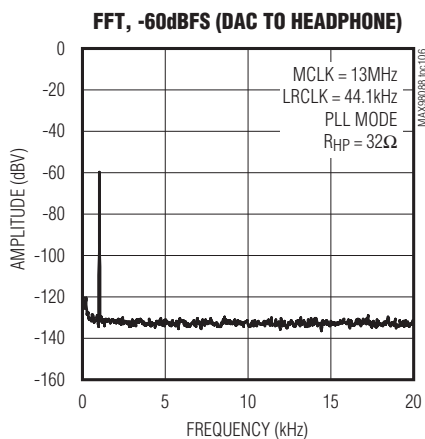
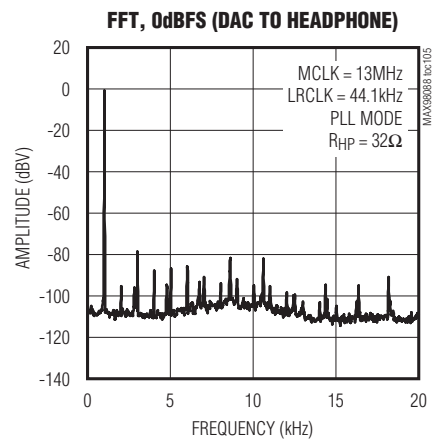
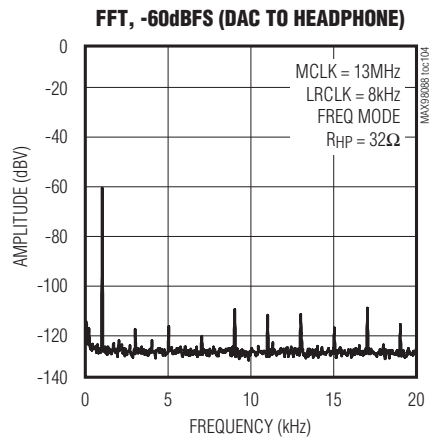
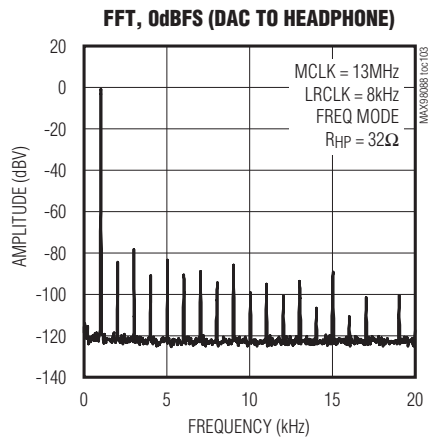

MAX98088

Stereo Audio Codec with FlexSound Technology

Typical Operating Characteristics (continued)

($V_{AVDD} = V_{PVDD} = V_{DVDD} = V_{DVDDS1} = V_{DVDDS2} = +1.8V$, $V_{SPKLVDD} = V_{SPKRVDD} = 3.7V$. Speaker loads (Z_{SPK}) connected between SPK_P and SPK_N. Receiver load (R_{REC}) connected between RECP and RECN. Headphone loads (R_{HP}) connected from HPL or HPR to HPGND. $R_{HP} = \infty$, $R_{REC} = \infty$, $Z_{SPK} = \infty$, $C_{REF} = 2.2\mu F$, $C_{MICBIAS} = C_{REG} = 1\mu F$, $C_{C1N-C1P} = 1\mu F$, $C_{HPVDD} = C_{HPVSS} = 1\mu F$. $AV_{MICPRE_} = +20dB$, $AV_{MICPGA_} = 0dB$, $AV_{DACATTN} = 0dB$, $AV_{DACGAIN} = 0dB$, $AV_{ADCLVL} = 0dB$, $AV_{ADCGAIN} = 0dB$, $AV_{PGAIN_} = 0dB$, $AV_{HP_} = 0dB$, $AV_{REC} = 0dB$, $AV_{SPK_} = 0dB$, $MCLK = 12.288MHz$, $LRCLK = 48kHz$, $MAS = 1$. $T_A = +25^\circ C$, unless otherwise noted.)

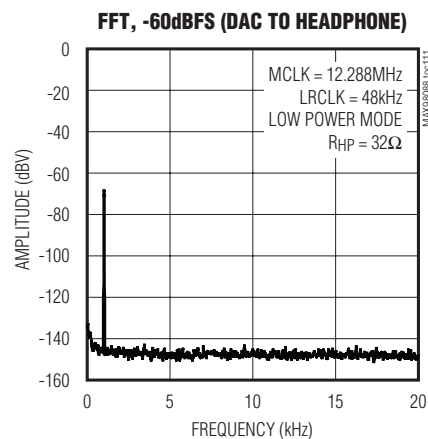
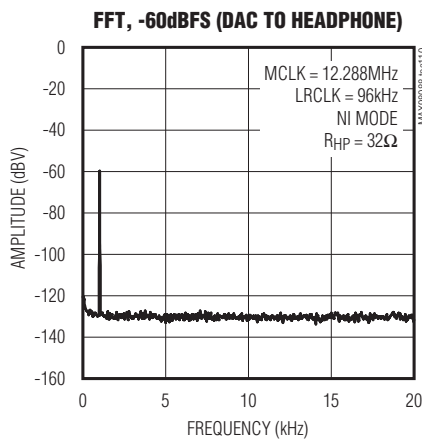
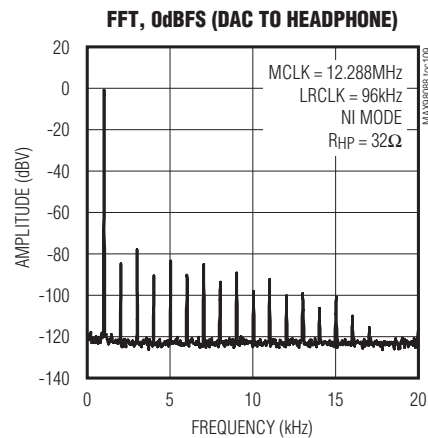
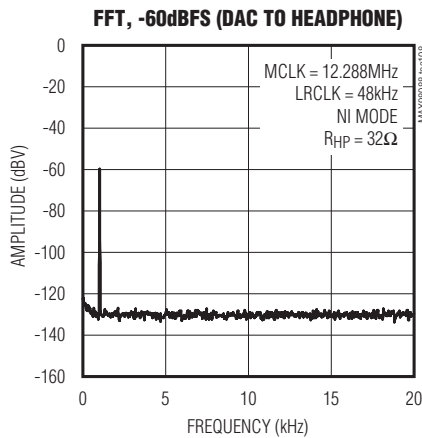

MAX98088

Stereo Audio Codec with FlexSound Technology

Typical Operating Characteristics (continued)

($V_{AVDD} = V_{PVDD} = V_{DVDD} = V_{DVDDS1} = V_{DVDDS2} = +1.8V$, $V_{SPKLVDD} = V_{SPKRVDD} = 3.7V$. Speaker loads (Z_{SPK}) connected between SPK_P and SPK_N. Receiver load (R_{REC}) connected between RECP and RECN. Headphone loads (R_{HP}) connected from HPL or HPR to HPGND. $R_{HP} = \infty$, $R_{REC} = \infty$, $Z_{SPK} = \infty$, $C_{REF} = 2.2\mu F$, $C_{MICBIAS} = C_{REG} = 1\mu F$, $C_{C1N-C1P} = 1\mu F$, $C_{HPVDD} = C_{HPVSS} = 1\mu F$. $AV_{MICPRE_} = +20dB$, $AV_{MICPGA_} = 0dB$, $AV_{DACATTN} = 0dB$, $AV_{DACGAIN} = 0dB$, $AV_{ADCLVL} = 0dB$, $AV_{ADCGAIN} = 0dB$, $AV_{PGAIN_} = 0dB$, $AV_{HP_} = 0dB$, $AV_{REC} = 0dB$, $AV_{SPK_} = 0dB$, $MCLK = 12.288MHz$, $LRCLK = 48kHz$, $MAS = 1$. $T_A = +25^\circ C$, unless otherwise noted.)

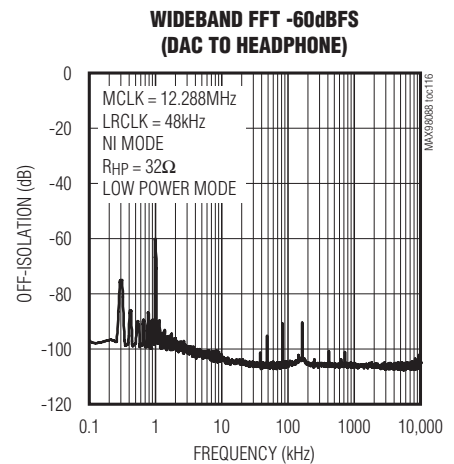
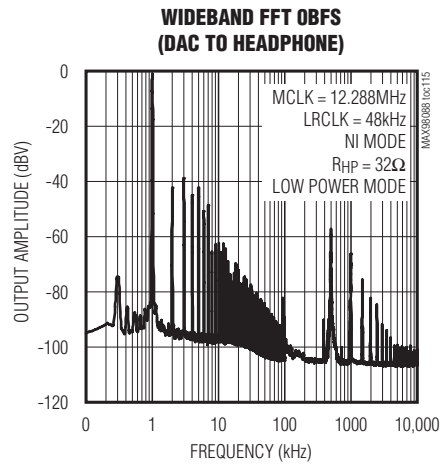
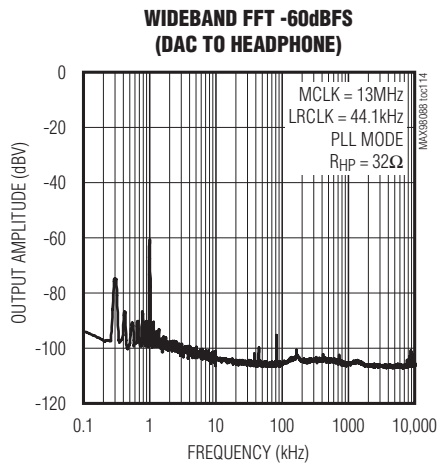
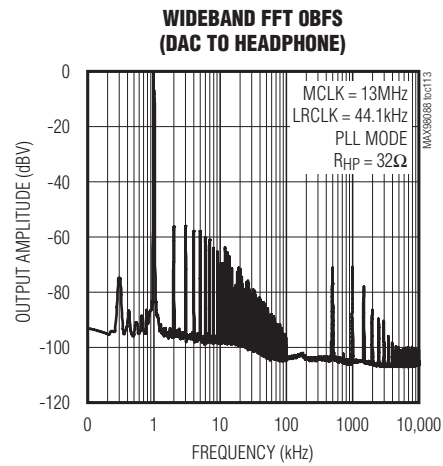
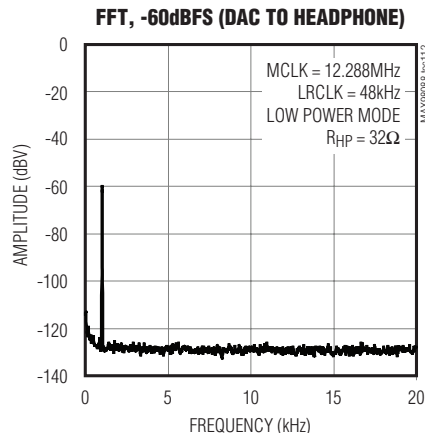

Stereo Audio Codec with FlexSound Technology

Typical Operating Characteristics (continued)

($V_{AVDD} = V_{PVDD} = V_{DVDD} = V_{DVDDS1} = V_{DVDDS2} = +1.8V$, $V_{SPKLVDD} = V_{SPKRVD} = 3.7V$. Speaker loads (Z_{SPK}) connected between SPK_P and SPK_N. Receiver load (R_{REC}) connected between RECP and RECN. Headphone loads (R_{HP}) connected from HPL or HPR to HPGND. $R_{HP} = \infty$, $R_{REC} = \infty$, $Z_{SPK} = \infty$, $C_{REF} = 2.2\mu F$, $C_{MICBIAS} = C_{REG} = 1\mu F$, $C_{C1N-C1P} = 1\mu F$, $C_{HPVDD} = C_{HPVSS} = 1\mu F$. $AV_{MICPRE_} = +20dB$, $AV_{MICPGA_} = 0dB$, $AV_{DACATTN} = 0dB$, $AV_{DACGAIN} = 0dB$, $AV_{ADCLVL} = 0dB$, $AV_{ADCGAIN} = 0dB$, $AV_{PGAIN_} = 0dB$, $AV_{HP_} = 0dB$, $AV_{REC} = 0dB$, $AV_{SPK_} = 0dB$, $MCLK = 12.288MHz$, $LRCLK = 48kHz$, $MAS = 1$. $T_A = +25^\circ C$, unless otherwise noted.)

Line to Headphone

TOTAL HARMONIC DISTORTION PLUS NOISE vs. OUTPUT POWER (LINE TO HEADPHONE)

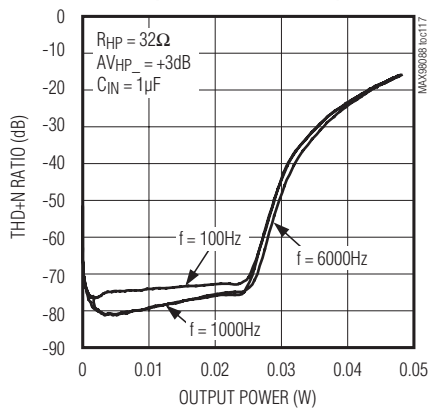

TOTAL HARMONIC DISTORTION PLUS NOISE vs. FREQUENCY (LINE TO HEADPHONE)

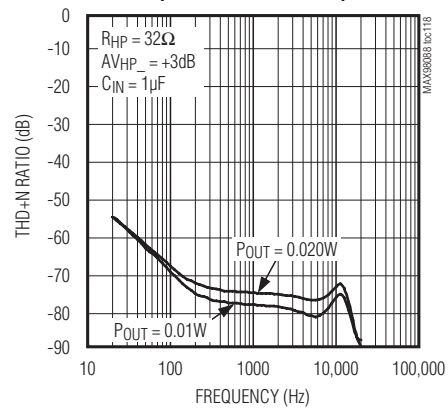

GAIN vs. FREQUENCY (LINE TO HEADPHONE)

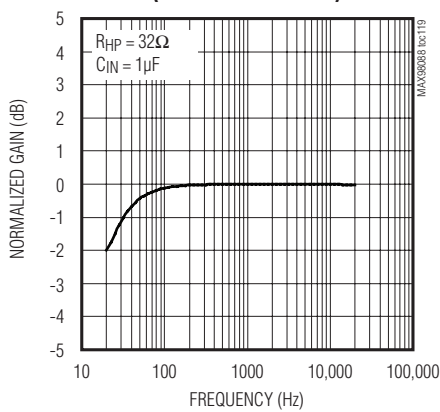

POWER-SUPPLY REJECTION RATIO vs. FREQUENCY (LINE TO HEADPHONE)

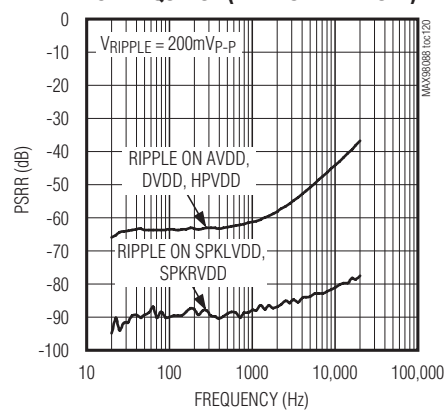

CROSSTALK vs. FREQUENCY (LINE TO HEADPHONES)

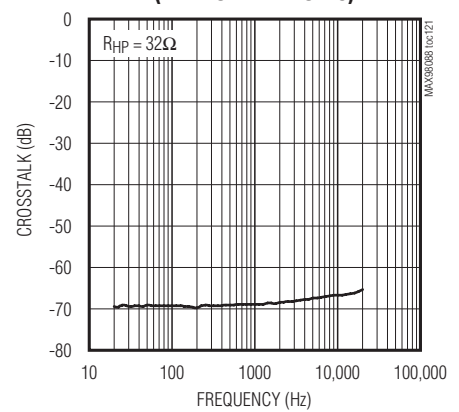

Stereo Audio Codec with FlexSound Technology

Typical Operating Characteristics (continued)

($V_{AVDD} = V_{PVDD} = V_{DVDD} = V_{DVDDS1} = V_{DVDDS2} = +1.8V$, $V_{SPKLVDD} = V_{SPKRVDD} = 3.7V$. Speaker loads (Z_{SPK}) connected between SPK_P and SPK_N . Receiver load (R_{REC}) connected between $RECP$ and $RECN$. Headphone loads (R_{HP}) connected from HPL or HPR to $HPGND$. $R_{HP} = \infty$, $R_{REC} = \infty$, $Z_{SPK} = \infty$, $C_{REF} = 2.2\mu F$, $C_{MICBIAS} = C_{REG} = 1\mu F$, $C_{C1N-C1P} = 1\mu F$, $C_{HPVDD} = C_{HPVSS} = 1\mu F$. $AV_{MICPRE_} = +20dB$, $AV_{MICPGA_} = 0dB$, $AV_{DACATTN} = 0dB$, $AV_{DACGAIN} = 0dB$, $AV_{ADCLVL} = 0dB$, $AV_{ADCGAIN} = 0dB$, $AV_{PGAIN_} = 0dB$, $AV_{HP_} = 0dB$, $AV_{REC} = 0dB$, $AV_{SPK_} = 0dB$, $MCLK = 12.288MHz$, $LRCLK = 48kHz$, $MAS = 1$. $T_A = +25^\circ C$, unless otherwise noted.)

Speaker Bypass Switch

**COMMON-MODE REJECTION RATIO
vs. FREQUENCY (LINE TO HEADPHONES)**

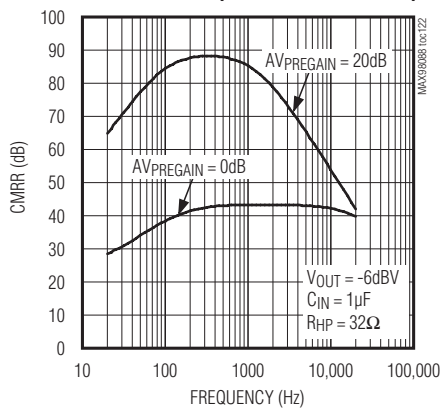

**TOTAL HARMONIC DISTORTION
PLUS NOISE vs. OUTPUT POWER
(SPEAKER BYPASS SWITCH)**

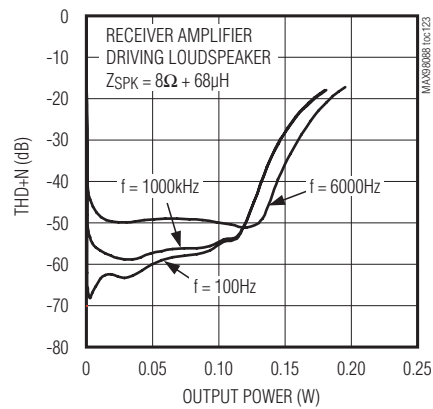

**ON-RESISTANCE vs. VCOM
(SPEAKER BYPASS SWITCH)**

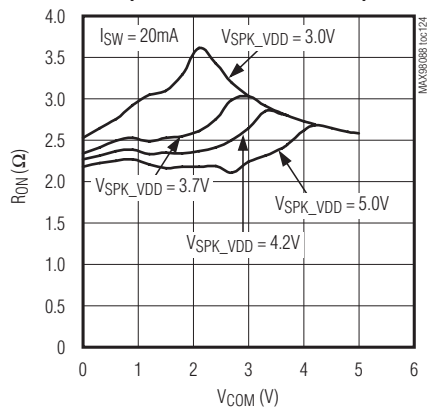

**OFF-ISOLATION vs. FREQUENCY
(SPEAKER BYPASS SWITCH)**

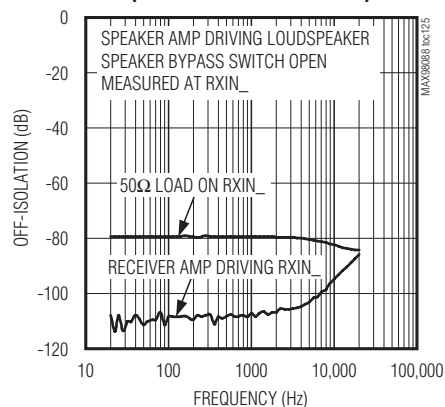

MAX98088

Stereo Audio Codec with FlexSound Technology

Pin Configuration

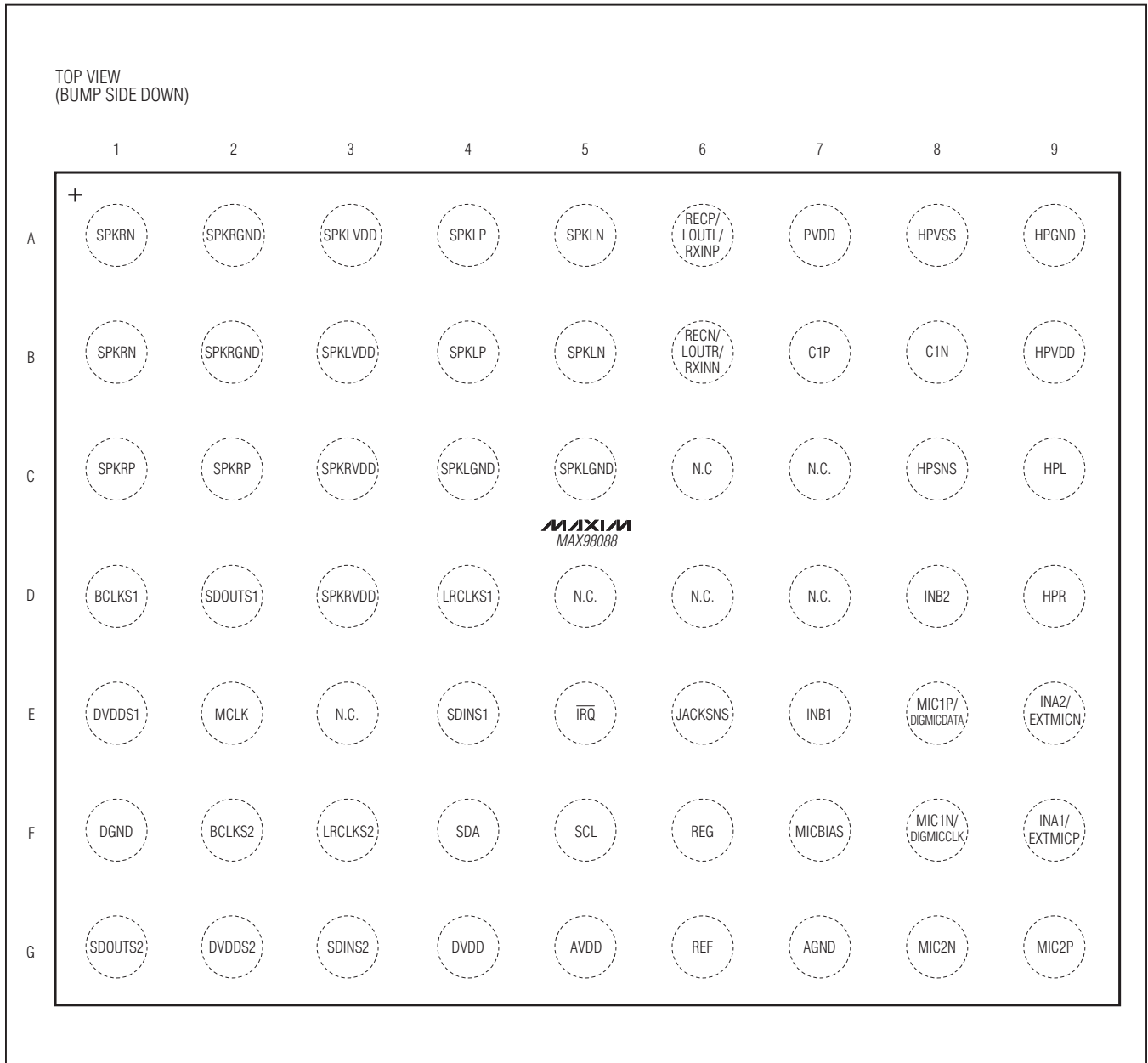

MAX98088

Stereo Audio Codec with FlexSound Technology

Pin Description

PIN	NAME	FUNCTION
A1, B1	SPKRN	Negative Right-Channel Class D Speaker Output
A2, B2	SPKRGND	Right-Speaker Ground
A3, B3	SPKLVDD	Left-Speaker, REF, Receiver Amp Power Supply. Bypass to SPKLGND with a 1 μ F and a 10 μ F capacitor.
A4, B4	SPKLP	Positive Left-Channel Class D Speaker Output
A5, B5	SPKLN	Negative Left-Channel Class D Speaker Output
A6	RECP/LOUTL/ RXINP	Positive Receiver Amplifier Output or Left Line Output. Can be positive bypass switch input when receiver amp is shut down.
A7	PVDD	Headphone Power Supply. Bypass to HPGND with 1 μ F and 10 μ F capacitors.
A8	HPVSS	Inverting Charge-Pump Output. Bypass to HPGND with a 1 μ F ceramic capacitor.
A9	HPGND	Headphone Ground
B6	REC�/LOUTR/ RXINN	Negative Receiver Amplifier Output or Right Line Output. Can be negative bypass switch input when receiver amp is shut down.
B7	C1P	Charge-Pump Flying Capacitor Positive Terminal. Connect a 1 μ F ceramic capacitor between C1N and C1P.
B8	C1N	Charge-Pump Flying Capacitor Negative Terminal. Connect a 1 μ F ceramic capacitor between C1N and C1P.
B9	HPVDD	Noninverting Charge-Pump Output. Bypass to HPGND with a 1 μ F ceramic capacitor.
C1, C2	SPKRP	Positive Right-Channel Class D Speaker Output
C3, D3	SPKRVDD	Right-Speaker Power Supply. Bypass to SPKRGND with a 1 μ F capacitor.
C4, C5	SPKLGND	Left-Speaker Ground
C6, C7, D5, D6, D7, E3	N.C.	No Connection
C8	HPSNS	Headphone Amplifier Ground Sense. Connect to the headphone jack ground terminal or connect to ground.
C9	HPL	Left-Channel Headphone Output
D1	BCLKS1	S1 Digital Audio Bit Clock Input/Output. BCLKS1 is an input when the IC is in slave mode and an output when in master mode. The input/output voltage is referenced to DVDDS1.
D2	SDOUTS1	S1 Digital Audio Serial-Data ADC Output. The output voltage is referenced to DVDDS1.
D4	LRCLKS1	S1 Digital Audio Left-Right Clock Input/Output. LRCLKS1 is the audio sample rate clock and determines whether S1 audio data is routed to the left or right channel. In TDM mode, LRCLKS1 is a frame sync pulse. LRCLKS1 is an input when the IC is in slave mode and an output when in master mode.
D8	INB2	Single-Ended Line Input B2. Also positive differential line input B.
D9	HPR	Right-Channel Headphone Output
E1	DVDDS1	S1 Digital Audio Interface Power-Supply Input. Bypass to DGND with a 1 μ F capacitor.
E2	MCLK	Master Clock Input. Acceptable input frequency range is 10MHz to 60MHz.
E4	SDINS1	S1 Digital Audio Serial-Data DAC Input. The input/output voltage is referenced to DVDDS1.

MAX98088

Stereo Audio Codec with FlexSound Technology

Pin Description (continued)

PIN	NAME	FUNCTION
E5	$\overline{\text{IRQ}}$	Hardware Interrupt Output. $\overline{\text{IRQ}}$ can be programmed to pull low when bits in status register 0x00 change state. Read status register 0x00 to clear $\overline{\text{IRQ}}$ once set. Repeat faults have no effect on $\overline{\text{IRQ}}$ until it is cleared by reading the I ² C status register 0x00. Connect a 10k Ω pullup resistor to DVDD for full output swing.
E6	JACKSNS	Jack Sense. Detects the insertion of a jack. See the <i>Jack Detection</i> section.
E7	INB1	Single-Ended Line Input B1. Also negative differential line input B.
E8	MIC1P/ DIGMICDATA	Positive Differential Microphone 1 Input. AC-couple a microphone with a series 1 μ F capacitor. Can be retasked as a digital microphone data input.
E9	INA2/ EXTMICN	Single-Ended Line Input A2. Also positive differential line input A or negative differential external microphone input.
F1	DGND	Digital Ground
F2	BCLKS2	S2 Digital Audio Bit Clock Input/Output. BCLKS2 is an input when the IC is in slave mode and an output when in master mode. The input/output voltage is referenced to DVDDS2.
F3	LRCLKS2	S2 Digital Audio Left-Right Clock Input/Output. LRCLKS2 is the audio sample rate clock and determines whether audio data on S2 is routed to the left or right channel. In TDM mode, LRCLKS2 is a frame sync pulse. LRCLKS2 is an input when the IC is in slave mode and an output when in master mode. The input/output voltage is referenced to DVDDS2.
F4	SDA	I ² C Serial-Data Input/Output. Connect a pullup resistor to DVDD for full output swing.
F5	SCL	I ² C Serial-Clock Input. Connect a pullup resistor to DVDD for full output swing.
F6	REG	Common-Mode Voltage Reference. Bypass to AGND with a 1 μ F capacitor.
F7	MICBIAS	Low-Noise Bias Voltage. Outputs a 2.2V microphone bias. An external 2.2k Ω resistor should be placed between MICBIAS and the microphone output.
F8	MIC1N/ DIGMICCLK	Negative Differential Microphone 1 Input. AC-couple a microphone with a series 1 μ F capacitor. Can be retasked as a digital microphone clock output.
F9	INA1/ EXTMICP	Single-Ended Line Input A1. Also negative differential line input A or positive differential external microphone input.
G1	SDOUTS2	S2 Digital Audio Serial-Data ADC Output. The output voltage is referenced to DVDDS2.
G2	DVDDS2	S2 Digital Audio Interface Power-Supply Input. Bypass to DGND with a 1 μ F capacitor.
G3	SDINS2	S2 Digital Audio Serial-Data DAC Input. The input voltage is referenced to DVDDS2.
G4	DVDD	Digital Power Supply. Supply for the digital core and I ² C interface. Bypass to DGND with a 1 μ F capacitor.
G5	AVDD	Analog Power Supply. Bypass to AGND with a 1 μ F capacitor.
G6	REF	Converter Reference. Bypass to AGND with a 2.2 μ F capacitor.
G7	AGND	Analog Ground
G8	MIC2N	Negative Differential Microphone 2 Input. AC-couple a microphone with a series 1 μ F capacitor.
G9	MIC2P	Positive Differential Microphone 2 Input. AC-couple a microphone with a series 1 μ F capacitor.

Stereo Audio Codec with FlexSound Technology

Detailed Description

The MAX98088 is a fully integrated stereo audio codec with FlexSound technology and integrated amplifiers.

Two differential microphone amplifiers can accept signals from three analog inputs. One input can be retasked to support two digital microphones. Any combination of two microphones (analog or digital) can be recorded simultaneously. The analog signals are amplified up to 50dB and recorded by the stereo ADC. The digital record path supports voice filtering with selectable preset highpass filters and high stopband attenuation at $f_s/2$. An automatic gain control (AGC) circuit monitors the digitized signal and automatically adjusts the analog microphone gain to make best use of the ADC's dynamic range. A noise gate attenuates signals below the user-defined threshold to minimize the noise output by the ADC.

The IC includes two analog line inputs. One of the line inputs can be optionally retasked as a third analog microphone input. Both line inputs support either stereo single-ended input signals or mono differential signals. The line inputs are preamplified and then routed to the ADC for recording and/or to the output amplifiers for playback. The single-ended line input signals from INA1 and INA2 can bypass the PGAs, and be connected directly to the ADC input to provide the best dynamic range.

Integrated analog switches allow two differential microphone signals to be routed out the third microphone input to an external device. This eliminates the need for an external analog switch in systems that have two devices recording signals from the same microphone.

Through two digital audio interfaces, the device can transmit one stereo audio signal and receive two stereo audio signals in a wide range of formats including I²S, PCM, and up to four mono slots in TDM. Each interface can be connected to either of two audio ports (S1 and S2) for communication with external devices. Both audio interfaces support 8kHz to 96kHz sample rates. Each input signal is independently equalized using 5-band parametric equalizers. A multiband automatic level control (ALC) boosts signals by up to 12dB. One signal path additionally supports the same voiceband filtering as the ADC path.

The IC includes a stereo Class D speaker amplifier, a high-efficiency Class H stereo headphone amplifier, and a differential receiver amplifier that can be configured as a stereo single-ended line output.

When the receiver amplifier is disabled, analog switches allow RECP/RXINP and RECN/RXINN to be reused for signal routing. In systems where a single transducer is used for both the loudspeaker and receiver, an external receiver amplifier can be routed to the left speaker through RECP/RXINP and RECN/RXINN, bypassing the Class D amplifier, to connect to the loudspeaker. If the internal receiver amplifier is used, then leave RECP/RXINP and RECN/RXINN unconnected. In systems where an external amplifier drives both the receiver and the MAX98088's line input, one of the differential signals can be disconnected from the receiver when not needed by passing it through the analog switch that connects RECP/RXINP to RECN/RXINN.

The stereo Class D amplifier provides efficient amplification for two speakers. The amplifier includes active emissions limiting to minimize the radiated emissions (EMI) traditionally associated with Class D. In most systems, no output filtering is required to meet standard EMI limits.

To optimize speaker sound quality, the IC includes an excursion limiter, a distortion limiter, and a power limiter. The excursion limiter is a dynamic highpass filter with variable corner frequency that increases in response to high signal levels. Low-frequency energy typically causes more distortion than useful sound at high signal levels, so attenuating low frequencies allows the speaker to play louder without distortion or damage. At lower signal levels, the filter corner frequency reduces to pass more low frequency energy when the speaker can handle it. The distortion limiter reduces the volume when the output signal exceeds a preset distortion level. This ensures that regardless of input signal and battery voltage, excessive distortion is never heard by the user. The power limiter monitors the continuous power into the loudspeaker and lowers the signal level if the speaker is at risk of overheating.

The stereo Class H headphone amplifier uses a dual-mode charge pump to maximize efficiency while outputting a ground-referenced signal. This eliminates the need for DC-blocking capacitors or a midrail bias for the headphone jack ground return. Ground sense reduces output noise caused by ground return current.

The IC integrates jack detection allowing the detection of insertion and removal of accessories.

Stereo Audio Codec with FlexSound Technology

I²C Slave Address

Configure the MAX98088 using the I²C control bus. The IC uses a slave address of 0x20 or 00100000 for write operations and 0x21 or 00100001 for read operations. See the [I²C Serial Interface](#) section for a complete interface description.

Registers

[Table 1](#) lists all of the registers, their addresses, and power-on-reset states. Registers 0x00 to 0x03 and 0xFF are read-only while all of the other registers are read/write. Write zeros to all unused bits in the register table when updating the register, unless otherwise noted.

Table 1. Register Map

REGISTER	B7	B6	B5	B4	B3	B2	B1	B0	ADDRESS	DEFAULT	R/W	PAGE
STATUS												
Status	CLD	SLD	ULK	—	—	—	JDET	—	0x00	—	R	111
Microphone AGC/NG	NG			AGC				—	0x01	—	R	70
Jack Status	—	JKSNS	—	—	—	—	—	—	0x02	—	R	110
Battery Voltage	—	—	—	VBAT				—	0x03	—	R/W	110
Interrupt Enable	ICLD	ISLD	IULK	0	0	0	IJDET	0	0x0F	0x00	R/W	111
MASTER CLOCK CONTROL												
Master Clock	0	0	PSClk		0	0	0	0	0x10	0x00	R/W	81
DAI1 CLOCK CONTROL												
Clock Mode	SR1				FREQ1				0x11	0x00	R/W	81, 82
Any Clock Control	PLL1	NI1[14:8]						—	0x12	0x00	R/W	82
	NI1[7:1]						NI1[0]	0x13	0x00	R/W	82	
DAI1 CONFIGURATION												
Format	MAS1	WC11	BC11	DLY1	0	TDM1	FSW1	WS1	0x14	0x00	R/W	76
Clock	ADC_OS1		DAC_OR1	0	0	BSEL1			0x15	0x00	R/W	77
I/O Configuration	SEL1		LTEN1	LBEN1	DMONO1	HIZOFF1	SDOEN1	SDIEN1	0x16	0x00	R/W	77, 78
Time-Division Multiplex	SLOTL1		SLOTR1		SLOTDL1				0x17	0x00	R/W	78
Filters	MODE1	AVFLT1			DHF1	DVFLT1			0x18	0x00	R/W	86
DAI2 CLOCK CONTROL												
Clock Mode	SR2				0	0	0	0	0x19	0x00	R/W	81
Any Clock Control	PLL2	NI2[14:8]						—	0x1A	0x00	R/W	82
	NI2[7:1]						NI2[0]	0x1B	0x00	R/W	82	
DAI2 CONFIGURATION												
Format	MAS2	WC12	BC12	DLY2	0	TDM2	FSW2	WS2	0x1C	0x00	R/W	76
Clock	0	0	DAC_OR2	0	0	BSEL2			0x1D	0x00	R/W	77
I/O Configuration	SEL2		0	LBEN2	DMONO2	HIZOFF2	SDOEN2	SDIEN2	0x1E	0x00	R/W	77, 78

Stereo Audio Codec with FlexSound Technology

Table 1. Register Map (continued)

REGISTER	B7	B6	B5	B4	B3	B2	B1	B0	ADDRESS	DEFAULT	R/W	PAGE
Time-Division Multiplex	SLOTL2		SLOTR2		SLOTDLY2				0x1F	0x00	R/W	78
Filters	0	0	0	0	DHF2	0	0	DCB2	0x20	0x00	R/W	86
SRC												
Sample Rate Converter	0	0	0	SRMIX_MODE	SRMIX_ENL	SRMIX_ENR	SRC_ENL	SRC_ENR	0x21	0x00	R/W	85
MIXERS												
DAC Mixer	MIXDAL				MIXDAR				0x22	0x00	R/W	92
Left ADC Mixer	MIXADL								0x23	0x00	R/W	69
Right ADC Mixer	MIXADR								0x24	0x00	R/W	69
Left Headphone Amplifier Mixer	MIXHPL								0x25	0x00	R/W	105
Right Headphone Amplifier Mixer	MIXHPR								0x26	0x00	R/W	105
Headphone Amplifier Mixer Control	0	0	MIXHPR_PATHSEL	MIXHPL_PATHSEL	MIXHPR_GAIN		MIXHPL_GAIN		0x27	0x00	R/W	105
Left Receiver Amplifier Mixer	MIXRECL								0x28	0x00	R/W	94
Right Receiver Amplifier Mixer	MIXRECR								0x29	0x00	R/W	94
Receiver Amplifier Mixer Control	LINE_MODE	0	0	0	MIXRECR_GAIN		MIXRECL_GAIN		0x2A	0x00	R/W	94
Left Speaker Amplifier Mixer	MIXSPL								0x2B	0x00	R/W	97
Right Speaker Amplifier Mixer	MIXSPR								0x2C	0x00	R/W	97
Speaker Amplifier Mixer Control	0	0	0	0	MIXSPR_GAIN		MIXSPL_GAIN		0x2D	0x00	R/W	97

Stereo Audio Codec with FlexSound Technology

Table 1. Register Map (continued)

REGISTER	B7	B6	B5	B4	B3	B2	B1	B0	ADDRESS	DEFAULT	R/W	PAGE
LEVEL CONTROL												
Sidetone	DSTS		0	DVST					0x2E	0x00	R/W	74
DAI1 Playback Level	DV1M	0	DV1G		DV1				0x2F	0x00	R/W	91
DAI1 Playback Level	0	0	0	$\overline{\text{EQCLP1}}$	DVEQ1				0x30	0x00	R/W	90
DAI2 Playback Level	DV2M	0	0	0	DV2				0x31	0x00	R/W	91
DAI2 Playback Level	0	0	0	$\overline{\text{EQCLP2}}$	DVEQ2				0x32	0x00	R/W	90
Left ADC Level	0	0	AVLG		AVL				0x33	0x00	R/W	73
Right ADC Level	0	0	AVRG		AVR				0x34	0x00	R/W	73
Microphone 1 Input Level	0	PA1EN		PGAM1					0x35	0x00	R/W	66
Microphone 2 Input Level	0	PA2EN		PGAM2					0x36	0x00	R/W	66
INA Input Level	0	INAEXT	0	0	0	PGAINA			0x37	0x00	R/W	68
INB Input Level	0	INBEXT	0	0	0	PGAINB			0x38	0x00	R/W	68
Left Headphone Amplifier Volume Control	HPLM	0	0	HPVOLL					0x39	0x00	R/W	106
Right Headphone Amplifier Volume Control	HPRM	0	0	HPVOLR					0x3A	0x00	R/W	106
Left Receiver Amplifier Volume Control	RECLM	0	0	RECVOLL					0x3B	0x00	R/W	95
Right Receiver Amplifier Volume Control	RECRM	0	0	RECVOLR					0x3C	0x00	R/W	95

Stereo Audio Codec with FlexSound Technology

Table 1. Register Map (continued)

REGISTER	B7	B6	B5	B4	B3	B2	B1	B0	ADDRESS	DEFAULT	R/W	PAGE
Left Speaker Amplifier Volume Control	SPLM	0	0	SPVOLL					0x3D	0x00	R/W	98
Right Speaker Amplifier Volume Control	SPRM	0	0	SPVOLR					0x3E	0x00	R/W	98
MICROPHONE AGC												
Configuration	AGCSRC	AGCRLS			AGCATK		AGCHLD		0x3F	0x00	R/W	70, 71
Threshold	ANTH				AGCTH				0x40	0x00	R/W	71
SPEAKER SIGNAL PROCESSING												
Excursion Limiter Filter	0	DHPUCF			0	0	DHPLCF		0x41	0x00	R/W	100
Excursion Limiter Threshold	0	0	0	0	0	DHPTH			0x42	0x00	R/W	100
ALC	ALCEN	ALCRLS			ALCMB		ALCTH		0x43	0x00	R/W	89, 100
Power Limiter	PWRTH				0	PWRK			0x44	0x00	R/W	101
Power Limiter	PWRT2				PWRT1				0x45	0x00	R/W	102
Distortion Limiter	THDCLP				0	0	0	THDT1	0x46	0x00	R/W	103
CONFIGURATION												
Audio Input	INADIFF	INBDIFF	0	0	0	0	0	0	0x47	0x00	R/W	68
Microphone	MICCLK		DIGMICL	DIGMICR	0	0	EXTMIC		0x48	0x00	R/W	66
Level Control	$\overline{VS2EN}$	\overline{VSEN}	\overline{ZDEN}	0	0	0	EQ2EN	EQ1EN	0x49	0x00	R/W	90, 108
Bypass Switches	INABYP	0	0	MIC2BYP	0	0	RECBYP	SPKBYP	0x4A	0x00	R/W	67, 107
Jack Detection	JDETEN	0	0	0	0	0	JDEB		0x4B	0x00	R/W	110
POWER MANAGEMENT												
Input Enable	INAEN	INBEN	0	0	MBEN	0	ADLEN	ADREN	0x4C	0x00	R/W	63
Output Enable	HPLEN	HPREN	SPLEN	SPREN	RECLN	RECREN	DALEN	DAREN	0x4D	0x00	R/W	64
Top-Level Bias Control	BGEN	SPREGEN	VCMEN	BIASEN	0	0	0	0	0x4E	0xF0	R/W	64
DAC Low Power Mode 1	DAI2_DAC_LP				DAI1_DAC_LP				0x4F	0x00	R/W	83
DAC Low Power Mode 2	0	0	0	0	DAC2_IP_DITH_EN	DAC1_IP_DITH_EN	CGM2_EN	CGM1_EN	0x50	0x0F	R/W	83
System Shutdown	\overline{SHDN}	VBATEN	0	0	PERFMODE	HPPLYBACK	PWRSV8K	PWRSV	0x51	0x00	R/W	63, 100

Stereo Audio Codec with FlexSound Technology

Table 1. Register Map (continued)

REGISTER	B7	B6	B5	B4	B3	B2	B1	B0	ADDRESS	DEFAULT	R/W	PAGE
DSP COEFFICIENTS												
EQ Band 1 (DAI1/DAI2)	K_1[15:8]								0x52/0x84	0xXX	R/W	89
	K_1[7:0]								0x53/0x85	0xXX	R/W	89
	K1_1[15:8]								0x54/0x86	0xXX	R/W	89
	K1_1[7:0]								0x55/0x87	0xXX	R/W	89
	K2_1[15:8]								0x56/0x88	0xXX	R/W	89
	K2_1[7:0]								0x57/0x89	0xXX	R/W	89
	c1_1[15:8]								0x58/0x8A	0xXX	R/W	89
	c1_1[7:0]								0x59/0x8B	0xXX	R/W	89
EQ Band 2 (DAI1/DAI2)	c2_1[15:8]								0x5A/0x8C	0xXX	R/W	89
	c2_1[7:0]								0x5B/0x8D	0xXX	R/W	89
	K_2[15:8]								0x5C/0x8E	0xXX	R/W	89
	K_2[7:0]								0x5D/0x8F	0xXX	R/W	89
	K1_2[15:8]								0x5E/0x90	0xXX	R/W	89
	K1_2[7:0]								0x5F/0x91	0xXX	R/W	89
	K2_2[15:8]								0x60/0x92	0xXX	R/W	89
	K2_2[7:0]								0x61/0x93	0xXX	R/W	89
EQ Band 3 (DAI1/DAI2)	c1_2[15:8]								0x62/0x94	0xXX	R/W	89
	c1_2[7:0]								0x63/0x95	0xXX	R/W	89
	c2_2[15:8]								0x64/0x96	0xXX	R/W	89
	c2_2[7:0]								0x65/0x97	0xXX	R/W	89
	K_3[15:8]								0x66/0x98	0xXX	R/W	89
	K_3[7:0]								0x67/0x99	0xXX	R/W	89
	K1_3[15:8]								0x68/0x9A	0xXX	R/W	89
	K1_3[7:0]								0x69/0x9B	0xXX	R/W	89
EQ Band 4 (DAI1/DAI2)	K2_3[15:8]								0x6A/0x9C	0xXX	R/W	89
	K2_3[7:0]								0x6B/0x9D	0xXX	R/W	89
	c1_3[15:8]								0x6C/0x9E	0xXX	R/W	89
	c1_3[7:0]								0x6D/0x9F	0xXX	R/W	89
	c2_3[15:8]								0x6E/0xA0	0xXX	R/W	89
	c2_3[7:0]								0x6F/0xA1	0xXX	R/W	89
	K_4[15:8]								0x70/0xA2	0xXX	R/W	89
	K_4[7:0]								0x71/0xA3	0xXX	R/W	89
EQ Band 4 (DAI1/DAI2)	K1_4[15:8]								0x72/0xA4	0xXX	R/W	89
	K1_4[7:0]								0x73/0xA5	0xXX	R/W	89
	K2_4[15:8]								0x74/0xA6	0xXX	R/W	89
	K2_4[7:0]								0x75/0xA7	0xXX	R/W	89
	c1_4[15:8]								0x76/0xA8	0xXX	R/W	89
	c1_4[7:0]								0x77/0xA9	0xXX	R/W	89
	c2_4[15:8]								0x78/0xAA	0xXX	R/W	89
	c2_4[7:0]								0x79/0xAB	0xXX	R/W	89

Stereo Audio Codec with FlexSound Technology

Table 1. Register Map (continued)

REGISTER	B7	B6	B5	B4	B3	B2	B1	B0	ADDRESS	DEFAULT	R/W	PAGE
EQ Band 5 (DAI1/DAI2)	K_5[15:8]								0x7A/0xAC	0xFF	R/W	89
	K_5[7:0]								0x7B/0xAD	0xFF	R/W	89
	K1_5[15:8]								0x7C/0xAE	0xFF	R/W	89
	K1_5[7:0]								0x7D/0xAF	0xFF	R/W	89
	K2_5[15:8]								0x7E/0xB0	0xFF	R/W	89
	K2_5[7:0]								0x7F/0xB1	0xFF	R/W	89
	c1_5[15:8]								0x80/0xB2	0xFF	R/W	89
	c1_5[7:0]								0x81/0xB3	0xFF	R/W	89
	c2_5[15:8]								0x82/0xB4	0xFF	R/W	89
	c2_5[7:0]								0x83/0xB5	0xFF	R/W	89
Excursion Limiter Biquad (DAI1/DAI2)	a1[15:8]								0xB6/0xC0	0xFF	R/W	89
	a1[7:0]								0xB7/0xC1	0xFF	R/W	89
	a2[15:8]								0xB8/0xC2	0xFF	R/W	89
	a2[7:0]								0xB9/0xC3	0xFF	R/W	89
	b0[15:8]								0xBA/0xC4	0xFF	R/W	89
	b0[7:0]								0xBB/0xC5	0xFF	R/W	89
	b1[15:8]								0xBC/0xC6	0xFF	R/W	89
	b1[7:0]								0xBD/0xC7	0xFF	R/W	89
	b2[15:8]								0xBE/0xC8	0xFF	R/W	89
b2[7:0]								0xBF/0xC9	0xFF	R/W	89	
REVISION ID												
Rev ID	REV								0xFF	0x40	R	112

MAX98088

Stereo Audio Codec with FlexSound Technology

Power Management

The IC includes comprehensive power management to allow the disabling of all unused circuits, minimizing supply current.

Table 2. Power Management Registers

REGISTER	BIT	NAME	DESCRIPTION
0x51	7	$\overline{\text{SHDN}}$	Global Shutdown. Disables everything except the headset detection circuitry, which is controlled separately. 0 = Device shutdown 1 = Device enabled
	6	VBATEN	See the <i>Battery Measurement</i> section.
	3	PERFMODE	Performance Mode. Selects DAC to headphone playback performance mode. 0 = High performance playback mode. 1 = Low power playback mode.
	2	HPPLYBCK	Headphone Only Playback Mode. Configures System Bias Control register bits for low power playback when using DAC to headphone playback path only. When enabled, this bit overrides the System Bias Control register settings. When disabled, the System Bias Control register is used to enable system bias blocks. Set both HPPLYBCK and PERFMODE for lowest power consumption when using DAC to headphone playback path only. 0 = Disabled 1 = Enabled
	1	PWRSV8K	8kHz Power Save Mode. PWRSV8K configures the ADC for reduced power consumption when $f_s = 8\text{kHz}$. PWRSV8K can be used in conjunction with PWRSV when $f_s = 8\text{kHz}$ for more power savings. 0 = Normal, high-performance mode. 1 = Low power mode.
	0	PWRSV	Power Save Mode. PWRSV configures the ADC for reduced power consumption for all sample rates. PWRSV can be used in conjunction with PWRSV8K for more power savings. 0 = Normal, high-performance mode. 1 = Low power mode.
0x4C	7	INAEN	Line Input A Enable 0 = Disabled 1 = Enabled
	6	INBEN	Line Input B Enable 0 = Disabled 1 = Enabled
	3	MBEN	Microphone Bias Enable 0 = Disabled 1 = Enabled
	1	ADLEN	Left ADC Enable 0 = Disabled 1 = Enabled
	0	ADREN	Right ADC Enable 0 = Disabled 1 = Enabled

Stereo Audio Codec with FlexSound Technology

Table 2. Power Management Registers (continued)

REGISTER	BIT	NAME	DESCRIPTION
0x4D	7	HPLEN	Left Headphone Enable 0 = Disabled 1 = Enabled
	6	HPREN	Right Headphone Enable 0 = Disabled 1 = Enabled
	5	SPLEN	Left Speaker Enable 0 = Disabled 1 = Enabled
	4	SPREN	Right Speaker Enable 0 = Disabled 1 = Enabled
	3	RECLLEN	Receiver/Left Line Output Enable. Use this bit to enable the differential receiver output or left line output. 0 = Disabled 1 = Enabled
	2	RECREN	Right Line Output Enable. Use this bit to enable the right line output. 0 = Disabled 1 = Enabled
	1	DALEN	Left DAC Enable 0 = Disabled 1 = Enabled
	0	DAREN	Right DAC Enable 0 = Disabled 1 = Enabled
0x4E	7	BGEN	Bandgap Enable. Must be enabled for proper operation of 2.5V regulator and associated circuitry. 0 = Disabled 1 = Enabled
	6	SPREGEN	2.5V Regulator Enable. SPREGEN enables a 2.5V internal regulator required for the ADC, speaker and receiver/line out amplifier. The 2.5V regulator is powered by SPKLVDD. 0 = Disabled 1 = Enabled
	5	VCMEN	Common-Mode Voltage Resistor String Enable. VCMEN enables the common mode voltage for the input and output amplifiers in the codec. 0 = Disabled 1 = Enabled
	4	BIASEN	Chip Bias Enable. BIASEN needs to be set for the codec amplifiers to be enabled. 0 = Disabled 1 = Enabled

Stereo Audio Codec with FlexSound Technology

Microphone Inputs

The device includes three differential microphone inputs and a low-noise microphone bias for powering the microphones (Figure 6). One microphone input can also be configured as a digital microphone input accepting signals from up to two digital microphones. Any two microphones, analog or digital, can be recorded simultaneously.

In the typical application, one microphone input is used for the handset microphone and the other is used as an accessory microphone. In systems using a background noise microphone, INA can be retasked as another microphone input.

In systems where the codec is not the only device recording microphone signals, connect microphones to MIC2P/MIC2N and EXTMICP/EXTMICN. MIC1P/MIC1N then become outputs that route the microphone signals to an external device as needed. Two devices can then record microphone signals without needing external analog switches.

Analog microphone signals are amplified by two stages of gain and then routed to the ADCs. The first stage offers selectable 0dB, 20dB, or 30dB settings. The second stage is a programmable-gain amplifier (PGA) adjustable from 0dB to 20dB in 1dB steps. To maximize the signal-to-noise ratio, use the gain in the first stage whenever possible. Zero-crossing detection is included on the PGA to minimize zipper noise while making gain changes.

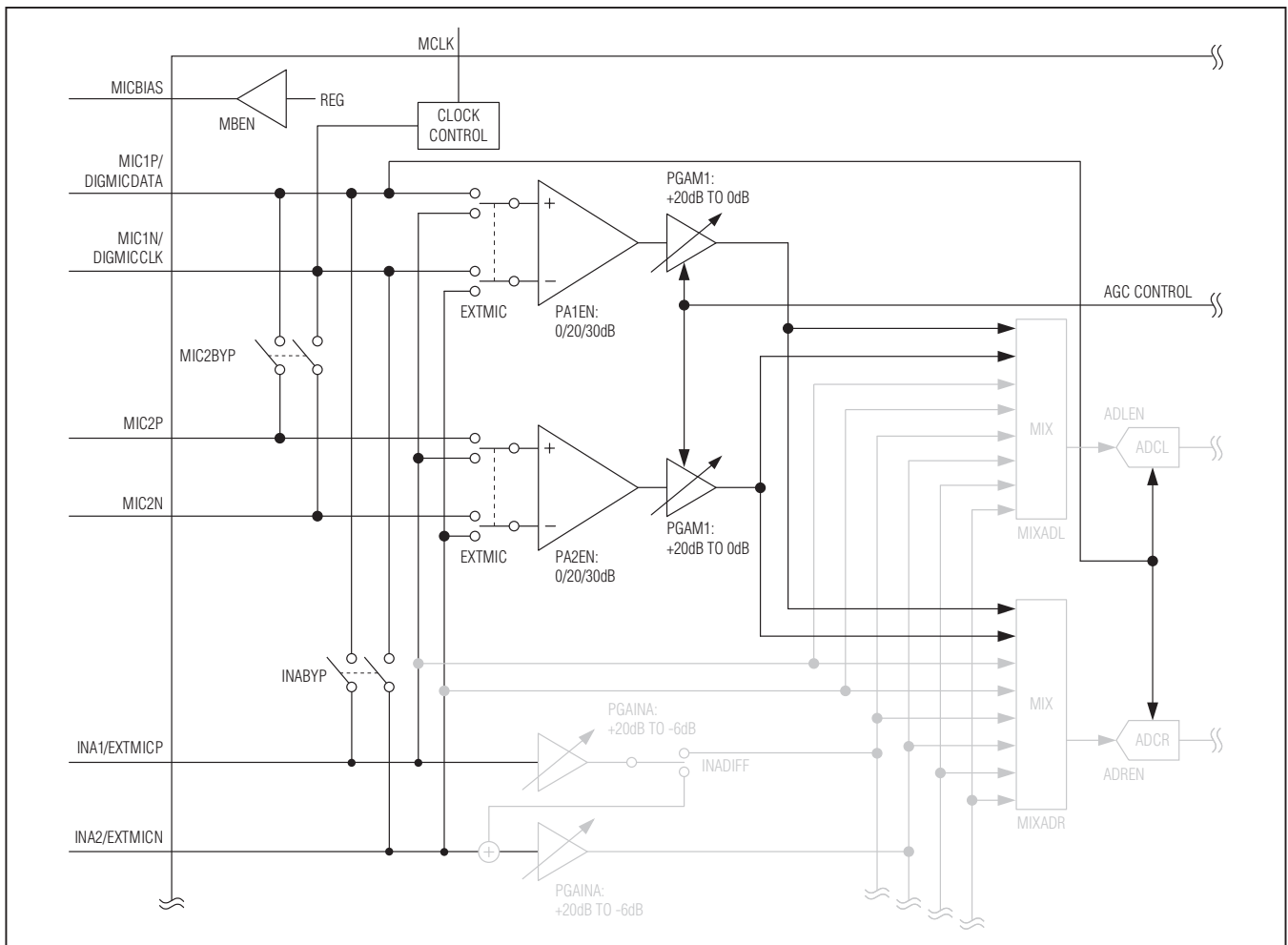

Figure 6. Microphone Input Block Diagram

Stereo Audio Codec with FlexSound Technology

Table 3. Microphone Input Registers

REGISTER	BIT	NAME	DESCRIPTION																																																
0x35/0x36	6	PA1EN/PA2EN	MIC1/MIC2 Preampifier Gain Course microphone gain adjustment. 00 = Preampifier disabled 01 = 0dB 10 = 20dB 11 = 30dB																																																
	5																																																		
	4	PGAM1/PGAM2	MIC1/MIC2 PGA Fine microphone gain adjustment. <table border="1" style="width: 100%; border-collapse: collapse;"> <thead> <tr> <th>VALUE</th> <th>GAIN (dB)</th> <th>VALUE</th> <th>GAIN (dB)</th> </tr> </thead> <tbody> <tr> <td>0x00</td> <td>+20</td> <td>0x0B</td> <td>+9</td> </tr> <tr> <td>0x01</td> <td>+19</td> <td>0x0C</td> <td>+8</td> </tr> <tr> <td>0x02</td> <td>+18</td> <td>0x0D</td> <td>+7</td> </tr> <tr> <td>0x03</td> <td>+17</td> <td>0x0E</td> <td>+6</td> </tr> <tr> <td>0x04</td> <td>+16</td> <td>0x0F</td> <td>+5</td> </tr> <tr> <td>0x05</td> <td>+15</td> <td>0x10</td> <td>+4</td> </tr> <tr> <td>0x06</td> <td>+14</td> <td>0x11</td> <td>+3</td> </tr> <tr> <td>0x07</td> <td>+13</td> <td>0x12</td> <td>+2</td> </tr> <tr> <td>0x08</td> <td>+12</td> <td>0x13</td> <td>+1</td> </tr> <tr> <td>0x09</td> <td>+11</td> <td>0x14 to 0x1F</td> <td>0</td> </tr> <tr> <td>0x0A</td> <td>+10</td> <td></td> <td></td> </tr> </tbody> </table>	VALUE	GAIN (dB)	VALUE	GAIN (dB)	0x00	+20	0x0B	+9	0x01	+19	0x0C	+8	0x02	+18	0x0D	+7	0x03	+17	0x0E	+6	0x04	+16	0x0F	+5	0x05	+15	0x10	+4	0x06	+14	0x11	+3	0x07	+13	0x12	+2	0x08	+12	0x13	+1	0x09	+11	0x14 to 0x1F	0	0x0A	+10		
	VALUE			GAIN (dB)	VALUE	GAIN (dB)																																													
	0x00			+20	0x0B	+9																																													
	0x01			+19	0x0C	+8																																													
	0x02			+18	0x0D	+7																																													
	0x03			+17	0x0E	+6																																													
	0x04			+16	0x0F	+5																																													
	0x05			+15	0x10	+4																																													
	0x06			+14	0x11	+3																																													
	0x07			+13	0x12	+2																																													
	0x08			+12	0x13	+1																																													
0x09	+11	0x14 to 0x1F	0																																																
0x0A	+10																																																		
3																																																			
2																																																			
1																																																			
0																																																			
0x48	7	MICCLK	Digital Microphone Clock Frequency Select a frequency that is within the digital microphone's clock frequency range. Set OSR1 = 1 when using a digital microphone. 00 = PCLK/8 01 = PCLK/6 10 = 64 x LRCLK 11 = Reserved																																																
	6																																																		
	5	DIGMICL	Left Digital Microphone Enable Set PA1EN = 00 for proper operation. 0 = Disabled 1 = Enabled																																																
	4	DIGMICR	Right Digital Microphone Enable Set PA1EN = 00 for proper operation. 0 = Disabled 1 = Enabled																																																
	1	EXTMIC	External Microphone Connection Routes INA_/EXTMIC_ to the microphone preampifiers. Set INAEN = 0 when using INA_/EXTMIC_ as a microphone input. 00 = Disabled 01 = MIC1 input 10 = MIC2 input 11 = Reserved																																																
0																																																			

Stereo Audio Codec with FlexSound Technology

Table 3. Microphone Input Registers (continued)

REGISTER	BIT	NAME	DESCRIPTION
0x4A	7	INABYP	INA_/EXTMIC_ to MIC1_ Bypass Switch 0 = Disabled 1 = Enabled
	4	MIC2BYP	MIC1_ to MIC2_ Bypass Switch 0 = Disabled 1 = Enabled
	1	RECBYP	See the <i>Output Bypass Switches</i> section.
	0	SPKBYP	

Line Inputs

The device includes two sets of line inputs ([Figure 7](#)). Each set can be configured as a stereo single-ended input or as a mono differential input. Each input includes adjustable gain to match a wide range of input signal levels. If a custom gain is needed, the external gain mode provides a trimmed feedback resistor. Set the gain

by choosing the appropriate input resistor and using the following formula:

$$AV_{PGAIN} = 20 \times \log(20k\Omega/R_{IN})$$

The external gain mode also allows summing multiple signals into a single input, by connecting multiple input resistors as show in [Figure 8](#), and/or inputting signals larger than 1V_{p-p} by adjusting the ratio of the 20kΩ/R_{IN} less than 1.

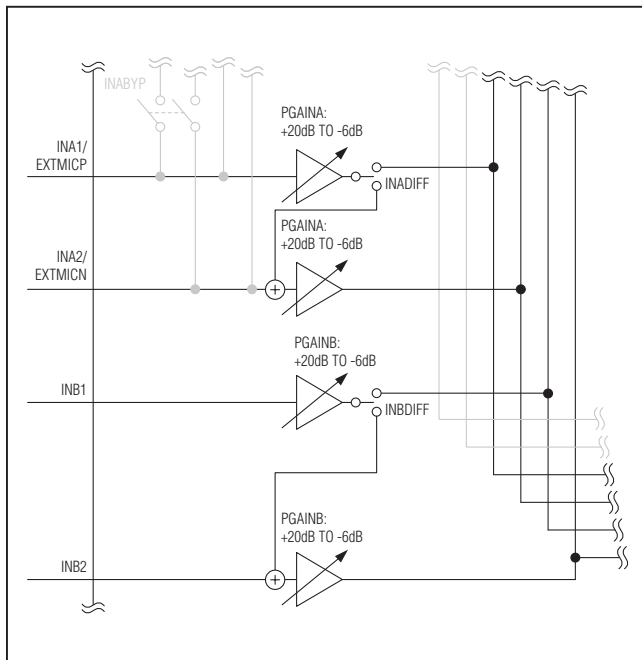

Figure 7. Line Input Block Diagram

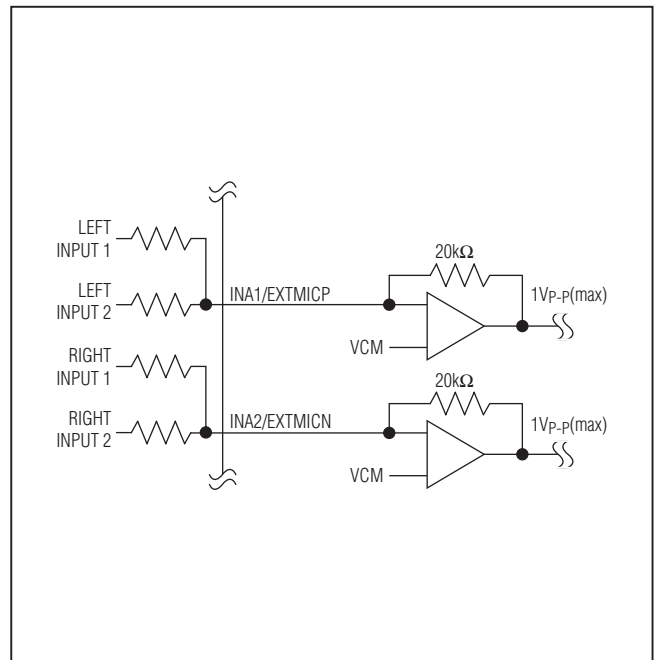

Figure 8. Summing Multiple Input Signals into INA/INB

Stereo Audio Codec with FlexSound Technology

Table 4. Line Input Registers

REGISTER	BIT	NAME	DESCRIPTION
0x37/0x38	6	INAEXT/INBEXT	Line Input A/B External Gain Switches out the internal input resistor and selects a trimmed 20kΩ feedback resistor. Use an external input resistor to set the gain of the line input. 0 = Disabled 1 = Enabled
	2	PGAINA/PGAINB	Line Input A/B Internal Gain Settings 000 = +20dB 001 = +14dB 010 = +3dB 011 = 0dB 100 = -3dB 101 = -6dB 110 = -6dB 111 = -6dB
	1		
	0		
0x47	7	INADIFF	Line Input A Differential Enable 0 = Stereo single-ended input 1 = Mono differential input
	6	INBDIFF	Line Input B Differential Enable 0 = Stereo single-ended input 1 = Mono differential input

ADC Input Mixers

The IC's stereo ADC accepts input from the microphone amplifiers, line inputs amplifiers, and directly from the INA1 and INA2. The ADC mixer routes any combination of the eight audio inputs to the left and right ADCs (Figure 9).

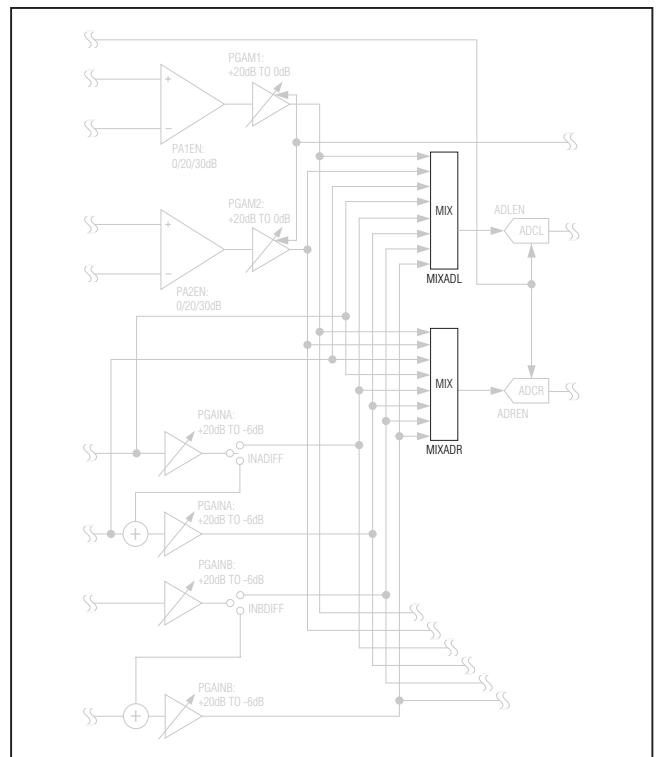

Figure 9. ADC Input Mixer Block Diagram

Stereo Audio Codec with FlexSound Technology

Table 5. ADC Input Mixer Register

REGISTER	BIT	NAME	DESCRIPTION
0x23/0x24	7	MIXADL/MIXADR	Left/Right ADC Input Mixer
	6		Selects which analog inputs are recorded by the left/right ADC.
	5		1xxxxxxx = MIC1
	4		x1xxxxxx = MIC2
	3		xx1xxxxx = INA1 pin direct
	2		xxx1xxxx = INA2 pin direct
	1		xxxx1xxx = INA1
	0		xxxxx1xx = INA2 (INADIFF = 0) or INA2 - INA1 (INADIFF = 1) xxxxxx1x = INB1 xxxxxxx1 = INB2 (INBDIFF = 0) or INB2 - INB1 (INBDIFF = 1)

Record Path Signal Processing

The device's record signal path includes both automatic gain control (AGC) for the microphone inputs and a digital noise gate at the output of the ADC (Figure 10).

Microphone AGC

The IC's AGC monitors the signal level at the output of the ADC and then adjusts the MIC1 and MIC2 analog PGA settings automatically. When the signal level is below the predefined threshold, the gain is increased up to its maximum (20dB). If the signal exceeds the threshold, the gain is reduced to prevent the output signal level exceeding the threshold. When AGC is enabled, the microphone PGA is not user programmable. The AGC provides a more constant signal level and improves the available ADC dynamic range.

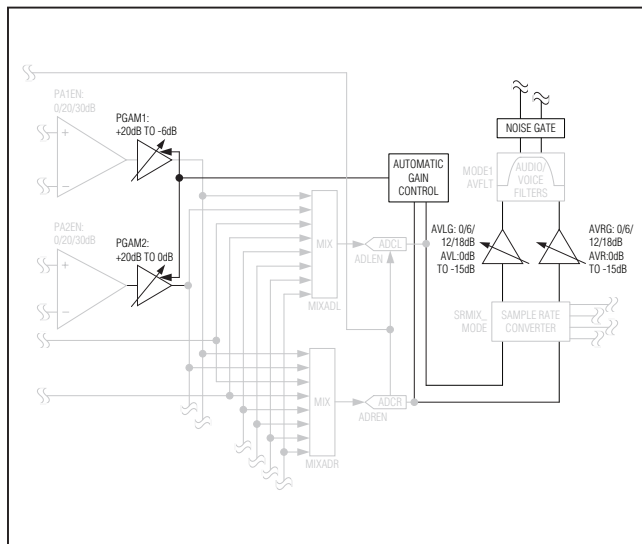

Figure 10. Record Path Signal Processing Block Diagram

Noise Gate

Since the AGC increases the levels of all signals below a user-defined threshold, the noise floor is effectively increased by 20dB. To counteract this, the noise gate reduces the gain at low signal levels. Unlike typical noise gates that completely silence the output below a defined level, the noise gate in the IC applies downward expansion. The noise gate attenuates the output at a rate of 1dB for each 2dB the signal is below the threshold with a maximum attenuation of 12dB.

The noise gate can be used in conjunction with the AGC or on its own. When the AGC is enabled, the noise gate reduces the output level only when the AGC has set the gain to the maximum setting. Figure 11 shows the gain response resulting from using the AGC and noise gate.

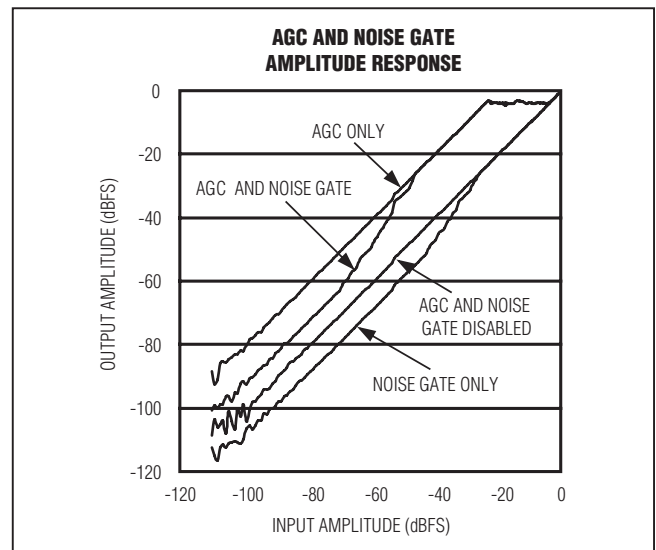

Figure 11. AGC and Noise Gate Input vs. Output Gain

Stereo Audio Codec with FlexSound Technology

Table 6. Record Path Signal Processing Registers

REGISTER	BIT	NAME	DESCRIPTION																																																
0x01	7	NG	Noise Gate Attenuation Reports the current noise gate attenuation. 000 = 0dB 001 = 1dB 010 = 2dB 011 = 3dB to 5dB 100 = 6dB to 7dB 101 = 8dB to 9dB 110 = 10dB to 11dB 111 = 12dB																																																
	6																																																		
	5																																																		
	4	AGC	AGC Gain Reports the current AGC gain setting.																																																
			<table border="1"> <thead> <tr> <th>VALUE</th> <th>GAIN (dB)</th> <th>VALUE</th> <th>GAIN (dB)</th> </tr> </thead> <tbody> <tr> <td>0x00</td> <td>+20</td> <td>0x0B</td> <td>+9</td> </tr> <tr> <td>0x01</td> <td>+19</td> <td>0x0C</td> <td>+8</td> </tr> <tr> <td>0x02</td> <td>+18</td> <td>0x0D</td> <td>+7</td> </tr> <tr> <td>0x03</td> <td>+17</td> <td>0x0E</td> <td>+6</td> </tr> <tr> <td>0x04</td> <td>+16</td> <td>0x0F</td> <td>+5</td> </tr> <tr> <td>0x05</td> <td>+15</td> <td>0x10</td> <td>+4</td> </tr> <tr> <td>0x06</td> <td>+14</td> <td>0x11</td> <td>+3</td> </tr> <tr> <td>0x07</td> <td>+13</td> <td>0x12</td> <td>+2</td> </tr> <tr> <td>0x08</td> <td>+12</td> <td>0x13</td> <td>+1</td> </tr> <tr> <td>0x09</td> <td>+11</td> <td>0x14 to 0x1F</td> <td>0</td> </tr> <tr> <td>0x0A</td> <td>+10</td> <td></td> <td></td> </tr> </tbody> </table>	VALUE	GAIN (dB)	VALUE	GAIN (dB)	0x00	+20	0x0B	+9	0x01	+19	0x0C	+8	0x02	+18	0x0D	+7	0x03	+17	0x0E	+6	0x04	+16	0x0F	+5	0x05	+15	0x10	+4	0x06	+14	0x11	+3	0x07	+13	0x12	+2	0x08	+12	0x13	+1	0x09	+11	0x14 to 0x1F	0	0x0A	+10		
	VALUE		GAIN (dB)	VALUE	GAIN (dB)																																														
	0x00		+20	0x0B	+9																																														
	0x01		+19	0x0C	+8																																														
	0x02		+18	0x0D	+7																																														
	0x03		+17	0x0E	+6																																														
	0x04		+16	0x0F	+5																																														
	0x05		+15	0x10	+4																																														
	0x06		+14	0x11	+3																																														
	0x07	+13	0x12	+2																																															
0x08	+12	0x13	+1																																																
0x09	+11	0x14 to 0x1F	0																																																
0x0A	+10																																																		
3																																																			
2																																																			
1																																																			
0																																																			
0x3F	7	AGCSRC	AGC/Noise Gate Signal Source Determines which ADC channel the AGC and noise gates analyze. Gain is adjusted on both channels regardless of the AGCSRC setting. 0 = Left ADC output 1 = Maximum of either the left or right ADC output																																																
	6	AGCRLS	AGC Release Time Defined as the duration from start to finish of gain increase in the region shown in Figure 12. 000 = 78ms 001 = 156ms 010 = 312ms 011 = 625ms 100 = 1.25s 101 = 2.5s 110 = 5s 111 = 10s																																																
	5																																																		
4																																																			

Stereo Audio Codec with FlexSound Technology

Table 6. Record Path Signal Processing Registers (continued)

REGISTER	BIT	NAME	DESCRIPTION																																				
0x3F	3	AGCATK	<p>AGC Attack Time Defined as the time required to reduce gain by 63% of the total gain reduction (one time constant of the exponential response). Attack times are longer for low AGC threshold levels. See Figure 12 for details. 00 = 2ms 01 = 7.2ms 10 = 31ms 11 = 123ms</p> <p>AGC Hold Time The delay before the AGC release begins. The hold time counter starts whenever the signal drops below the AGC threshold and is reset by any signal that exceeds the threshold. Set AGCHLD to enable the AGC circuit. See Figure 12 for details. 00 = AGC disabled 01 = 50ms 10 = 100ms 11 = 400ms</p>																																				
	2																																						
	1	AGCHLD																																					
	0																																						
0x40	7	ANTH	<p>Noise Gate Threshold Gain is reduced for signals below the threshold to quiet noise. The thresholds are relative to the ADC's full-scale output voltage.</p> <table border="1"> <thead> <tr> <th>VALUE</th> <th>THRESHOLD (dBFS)</th> <th>VALUE</th> <th>THRESHOLD (dBFS)</th> </tr> </thead> <tbody> <tr> <td>0x0</td> <td>Noise gate disabled</td> <td>0x8</td> <td>-45</td> </tr> <tr> <td>0x1</td> <td>Reserved</td> <td>0x9</td> <td>-41</td> </tr> <tr> <td>0x2</td> <td>Reserved</td> <td>0xA</td> <td>-38</td> </tr> <tr> <td>0x3</td> <td>-64</td> <td>0xB</td> <td>-34</td> </tr> <tr> <td>0x4</td> <td>-62</td> <td>0xC</td> <td>-30</td> </tr> <tr> <td>0x5</td> <td>-58</td> <td>0xD</td> <td>-27</td> </tr> <tr> <td>0x6</td> <td>-53</td> <td>0xE</td> <td>-22</td> </tr> <tr> <td>0x7</td> <td>-50</td> <td>0xF</td> <td>-16</td> </tr> </tbody> </table>	VALUE	THRESHOLD (dBFS)	VALUE	THRESHOLD (dBFS)	0x0	Noise gate disabled	0x8	-45	0x1	Reserved	0x9	-41	0x2	Reserved	0xA	-38	0x3	-64	0xB	-34	0x4	-62	0xC	-30	0x5	-58	0xD	-27	0x6	-53	0xE	-22	0x7	-50	0xF	-16
	VALUE		THRESHOLD (dBFS)	VALUE	THRESHOLD (dBFS)																																		
	0x0		Noise gate disabled	0x8	-45																																		
	0x1		Reserved	0x9	-41																																		
	0x2		Reserved	0xA	-38																																		
	0x3		-64	0xB	-34																																		
	0x4		-62	0xC	-30																																		
	0x5		-58	0xD	-27																																		
	0x6		-53	0xE	-22																																		
	0x7	-50	0xF	-16																																			
	6	AGCTH	<p>AGC Threshold Gain is reduced when signals exceed the threshold to prevent clipping. The thresholds are relative to the ADC's full-scale voltage.</p> <table border="1"> <thead> <tr> <th>VALUE</th> <th>THRESHOLD (dBFS)</th> <th>VALUE</th> <th>THRESHOLD (dBFS)</th> </tr> </thead> <tbody> <tr> <td>0x0</td> <td>-3</td> <td>0x8</td> <td>-11</td> </tr> <tr> <td>0x1</td> <td>-4</td> <td>0x9</td> <td>-12</td> </tr> <tr> <td>0x2</td> <td>-5</td> <td>0xA</td> <td>-13</td> </tr> <tr> <td>0x3</td> <td>-6</td> <td>0xB</td> <td>-14</td> </tr> <tr> <td>0x4</td> <td>-7</td> <td>0xC</td> <td>-15</td> </tr> <tr> <td>0x5</td> <td>-8</td> <td>0xD</td> <td>-16</td> </tr> <tr> <td>0x6</td> <td>-9</td> <td>0xE</td> <td>-17</td> </tr> <tr> <td>0x7</td> <td>-10</td> <td>0xF</td> <td>-18</td> </tr> </tbody> </table>	VALUE	THRESHOLD (dBFS)	VALUE	THRESHOLD (dBFS)	0x0	-3	0x8	-11	0x1	-4	0x9	-12	0x2	-5	0xA	-13	0x3	-6	0xB	-14	0x4	-7	0xC	-15	0x5	-8	0xD	-16	0x6	-9	0xE	-17	0x7	-10	0xF	-18
	VALUE		THRESHOLD (dBFS)	VALUE	THRESHOLD (dBFS)																																		
	0x0		-3	0x8	-11																																		
	0x1		-4	0x9	-12																																		
	0x2		-5	0xA	-13																																		
	0x3		-6	0xB	-14																																		
	0x4		-7	0xC	-15																																		
	0x5		-8	0xD	-16																																		
	0x6	-9	0xE	-17																																			
	0x7	-10	0xF	-18																																			
5	AGCTH	<table border="1"> <thead> <tr> <th>VALUE</th> <th>THRESHOLD (dBFS)</th> <th>VALUE</th> <th>THRESHOLD (dBFS)</th> </tr> </thead> <tbody> <tr> <td>0x0</td> <td>-3</td> <td>0x8</td> <td>-11</td> </tr> <tr> <td>0x1</td> <td>-4</td> <td>0x9</td> <td>-12</td> </tr> <tr> <td>0x2</td> <td>-5</td> <td>0xA</td> <td>-13</td> </tr> <tr> <td>0x3</td> <td>-6</td> <td>0xB</td> <td>-14</td> </tr> <tr> <td>0x4</td> <td>-7</td> <td>0xC</td> <td>-15</td> </tr> <tr> <td>0x5</td> <td>-8</td> <td>0xD</td> <td>-16</td> </tr> <tr> <td>0x6</td> <td>-9</td> <td>0xE</td> <td>-17</td> </tr> <tr> <td>0x7</td> <td>-10</td> <td>0xF</td> <td>-18</td> </tr> </tbody> </table>	VALUE	THRESHOLD (dBFS)	VALUE	THRESHOLD (dBFS)	0x0	-3	0x8	-11	0x1	-4	0x9	-12	0x2	-5	0xA	-13	0x3	-6	0xB	-14	0x4	-7	0xC	-15	0x5	-8	0xD	-16	0x6	-9	0xE	-17	0x7	-10	0xF	-18	
VALUE		THRESHOLD (dBFS)	VALUE	THRESHOLD (dBFS)																																			
0x0		-3	0x8	-11																																			
0x1		-4	0x9	-12																																			
0x2		-5	0xA	-13																																			
0x3		-6	0xB	-14																																			
0x4		-7	0xC	-15																																			
0x5	-8	0xD	-16																																				
0x6	-9	0xE	-17																																				
0x7	-10	0xF	-18																																				
4	AGCTH	<table border="1"> <thead> <tr> <th>VALUE</th> <th>THRESHOLD (dBFS)</th> <th>VALUE</th> <th>THRESHOLD (dBFS)</th> </tr> </thead> <tbody> <tr> <td>0x0</td> <td>-3</td> <td>0x8</td> <td>-11</td> </tr> <tr> <td>0x1</td> <td>-4</td> <td>0x9</td> <td>-12</td> </tr> <tr> <td>0x2</td> <td>-5</td> <td>0xA</td> <td>-13</td> </tr> <tr> <td>0x3</td> <td>-6</td> <td>0xB</td> <td>-14</td> </tr> <tr> <td>0x4</td> <td>-7</td> <td>0xC</td> <td>-15</td> </tr> <tr> <td>0x5</td> <td>-8</td> <td>0xD</td> <td>-16</td> </tr> <tr> <td>0x6</td> <td>-9</td> <td>0xE</td> <td>-17</td> </tr> <tr> <td>0x7</td> <td>-10</td> <td>0xF</td> <td>-18</td> </tr> </tbody> </table>	VALUE	THRESHOLD (dBFS)	VALUE	THRESHOLD (dBFS)	0x0	-3	0x8	-11	0x1	-4	0x9	-12	0x2	-5	0xA	-13	0x3	-6	0xB	-14	0x4	-7	0xC	-15	0x5	-8	0xD	-16	0x6	-9	0xE	-17	0x7	-10	0xF	-18	
VALUE		THRESHOLD (dBFS)	VALUE	THRESHOLD (dBFS)																																			
0x0		-3	0x8	-11																																			
0x1		-4	0x9	-12																																			
0x2		-5	0xA	-13																																			
0x3		-6	0xB	-14																																			
0x4	-7	0xC	-15																																				
0x5	-8	0xD	-16																																				
0x6	-9	0xE	-17																																				
0x7	-10	0xF	-18																																				
3	AGCTH	<table border="1"> <thead> <tr> <th>VALUE</th> <th>THRESHOLD (dBFS)</th> <th>VALUE</th> <th>THRESHOLD (dBFS)</th> </tr> </thead> <tbody> <tr> <td>0x0</td> <td>-3</td> <td>0x8</td> <td>-11</td> </tr> <tr> <td>0x1</td> <td>-4</td> <td>0x9</td> <td>-12</td> </tr> <tr> <td>0x2</td> <td>-5</td> <td>0xA</td> <td>-13</td> </tr> <tr> <td>0x3</td> <td>-6</td> <td>0xB</td> <td>-14</td> </tr> <tr> <td>0x4</td> <td>-7</td> <td>0xC</td> <td>-15</td> </tr> <tr> <td>0x5</td> <td>-8</td> <td>0xD</td> <td>-16</td> </tr> <tr> <td>0x6</td> <td>-9</td> <td>0xE</td> <td>-17</td> </tr> <tr> <td>0x7</td> <td>-10</td> <td>0xF</td> <td>-18</td> </tr> </tbody> </table>	VALUE	THRESHOLD (dBFS)	VALUE	THRESHOLD (dBFS)	0x0	-3	0x8	-11	0x1	-4	0x9	-12	0x2	-5	0xA	-13	0x3	-6	0xB	-14	0x4	-7	0xC	-15	0x5	-8	0xD	-16	0x6	-9	0xE	-17	0x7	-10	0xF	-18	
VALUE		THRESHOLD (dBFS)	VALUE	THRESHOLD (dBFS)																																			
0x0		-3	0x8	-11																																			
0x1		-4	0x9	-12																																			
0x2		-5	0xA	-13																																			
0x3	-6	0xB	-14																																				
0x4	-7	0xC	-15																																				
0x5	-8	0xD	-16																																				
0x6	-9	0xE	-17																																				
0x7	-10	0xF	-18																																				
2	AGCTH	<table border="1"> <thead> <tr> <th>VALUE</th> <th>THRESHOLD (dBFS)</th> <th>VALUE</th> <th>THRESHOLD (dBFS)</th> </tr> </thead> <tbody> <tr> <td>0x0</td> <td>-3</td> <td>0x8</td> <td>-11</td> </tr> <tr> <td>0x1</td> <td>-4</td> <td>0x9</td> <td>-12</td> </tr> <tr> <td>0x2</td> <td>-5</td> <td>0xA</td> <td>-13</td> </tr> <tr> <td>0x3</td> <td>-6</td> <td>0xB</td> <td>-14</td> </tr> <tr> <td>0x4</td> <td>-7</td> <td>0xC</td> <td>-15</td> </tr> <tr> <td>0x5</td> <td>-8</td> <td>0xD</td> <td>-16</td> </tr> <tr> <td>0x6</td> <td>-9</td> <td>0xE</td> <td>-17</td> </tr> <tr> <td>0x7</td> <td>-10</td> <td>0xF</td> <td>-18</td> </tr> </tbody> </table>	VALUE	THRESHOLD (dBFS)	VALUE	THRESHOLD (dBFS)	0x0	-3	0x8	-11	0x1	-4	0x9	-12	0x2	-5	0xA	-13	0x3	-6	0xB	-14	0x4	-7	0xC	-15	0x5	-8	0xD	-16	0x6	-9	0xE	-17	0x7	-10	0xF	-18	
VALUE		THRESHOLD (dBFS)	VALUE	THRESHOLD (dBFS)																																			
0x0		-3	0x8	-11																																			
0x1		-4	0x9	-12																																			
0x2	-5	0xA	-13																																				
0x3	-6	0xB	-14																																				
0x4	-7	0xC	-15																																				
0x5	-8	0xD	-16																																				
0x6	-9	0xE	-17																																				
0x7	-10	0xF	-18																																				
1	AGCTH	<table border="1"> <thead> <tr> <th>VALUE</th> <th>THRESHOLD (dBFS)</th> <th>VALUE</th> <th>THRESHOLD (dBFS)</th> </tr> </thead> <tbody> <tr> <td>0x0</td> <td>-3</td> <td>0x8</td> <td>-11</td> </tr> <tr> <td>0x1</td> <td>-4</td> <td>0x9</td> <td>-12</td> </tr> <tr> <td>0x2</td> <td>-5</td> <td>0xA</td> <td>-13</td> </tr> <tr> <td>0x3</td> <td>-6</td> <td>0xB</td> <td>-14</td> </tr> <tr> <td>0x4</td> <td>-7</td> <td>0xC</td> <td>-15</td> </tr> <tr> <td>0x5</td> <td>-8</td> <td>0xD</td> <td>-16</td> </tr> <tr> <td>0x6</td> <td>-9</td> <td>0xE</td> <td>-17</td> </tr> <tr> <td>0x7</td> <td>-10</td> <td>0xF</td> <td>-18</td> </tr> </tbody> </table>	VALUE	THRESHOLD (dBFS)	VALUE	THRESHOLD (dBFS)	0x0	-3	0x8	-11	0x1	-4	0x9	-12	0x2	-5	0xA	-13	0x3	-6	0xB	-14	0x4	-7	0xC	-15	0x5	-8	0xD	-16	0x6	-9	0xE	-17	0x7	-10	0xF	-18	
VALUE		THRESHOLD (dBFS)	VALUE	THRESHOLD (dBFS)																																			
0x0		-3	0x8	-11																																			
0x1	-4	0x9	-12																																				
0x2	-5	0xA	-13																																				
0x3	-6	0xB	-14																																				
0x4	-7	0xC	-15																																				
0x5	-8	0xD	-16																																				
0x6	-9	0xE	-17																																				
0x7	-10	0xF	-18																																				
0	AGCTH	<table border="1"> <thead> <tr> <th>VALUE</th> <th>THRESHOLD (dBFS)</th> <th>VALUE</th> <th>THRESHOLD (dBFS)</th> </tr> </thead> <tbody> <tr> <td>0x0</td> <td>-3</td> <td>0x8</td> <td>-11</td> </tr> <tr> <td>0x1</td> <td>-4</td> <td>0x9</td> <td>-12</td> </tr> <tr> <td>0x2</td> <td>-5</td> <td>0xA</td> <td>-13</td> </tr> <tr> <td>0x3</td> <td>-6</td> <td>0xB</td> <td>-14</td> </tr> <tr> <td>0x4</td> <td>-7</td> <td>0xC</td> <td>-15</td> </tr> <tr> <td>0x5</td> <td>-8</td> <td>0xD</td> <td>-16</td> </tr> <tr> <td>0x6</td> <td>-9</td> <td>0xE</td> <td>-17</td> </tr> <tr> <td>0x7</td> <td>-10</td> <td>0xF</td> <td>-18</td> </tr> </tbody> </table>	VALUE	THRESHOLD (dBFS)	VALUE	THRESHOLD (dBFS)	0x0	-3	0x8	-11	0x1	-4	0x9	-12	0x2	-5	0xA	-13	0x3	-6	0xB	-14	0x4	-7	0xC	-15	0x5	-8	0xD	-16	0x6	-9	0xE	-17	0x7	-10	0xF	-18	
VALUE	THRESHOLD (dBFS)	VALUE	THRESHOLD (dBFS)																																				
0x0	-3	0x8	-11																																				
0x1	-4	0x9	-12																																				
0x2	-5	0xA	-13																																				
0x3	-6	0xB	-14																																				
0x4	-7	0xC	-15																																				
0x5	-8	0xD	-16																																				
0x6	-9	0xE	-17																																				
0x7	-10	0xF	-18																																				

Stereo Audio Codec with FlexSound Technology

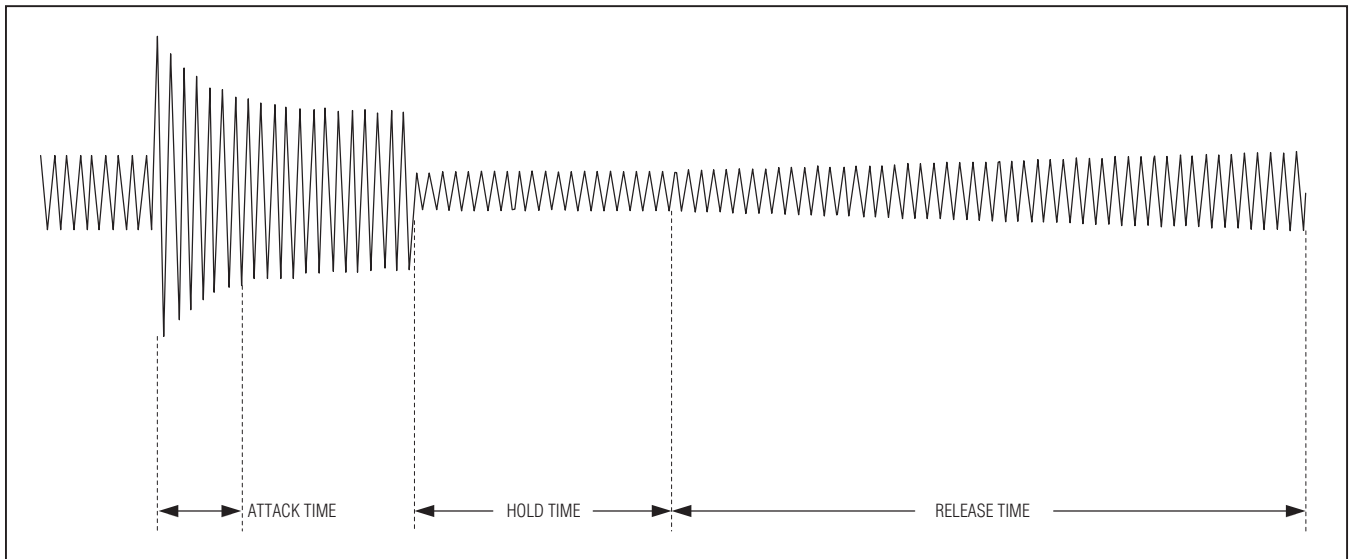

Figure 12. AGC Timing

ADC Record Level Control

The IC includes separate digital level control for the left and right ADC outputs (Figure 13). To optimize dynamic range, use analog gain to adjust the signal level and set

the digital level control to 0dB whenever possible. Digital level control is primarily used when adjusting the record level for digital microphones.

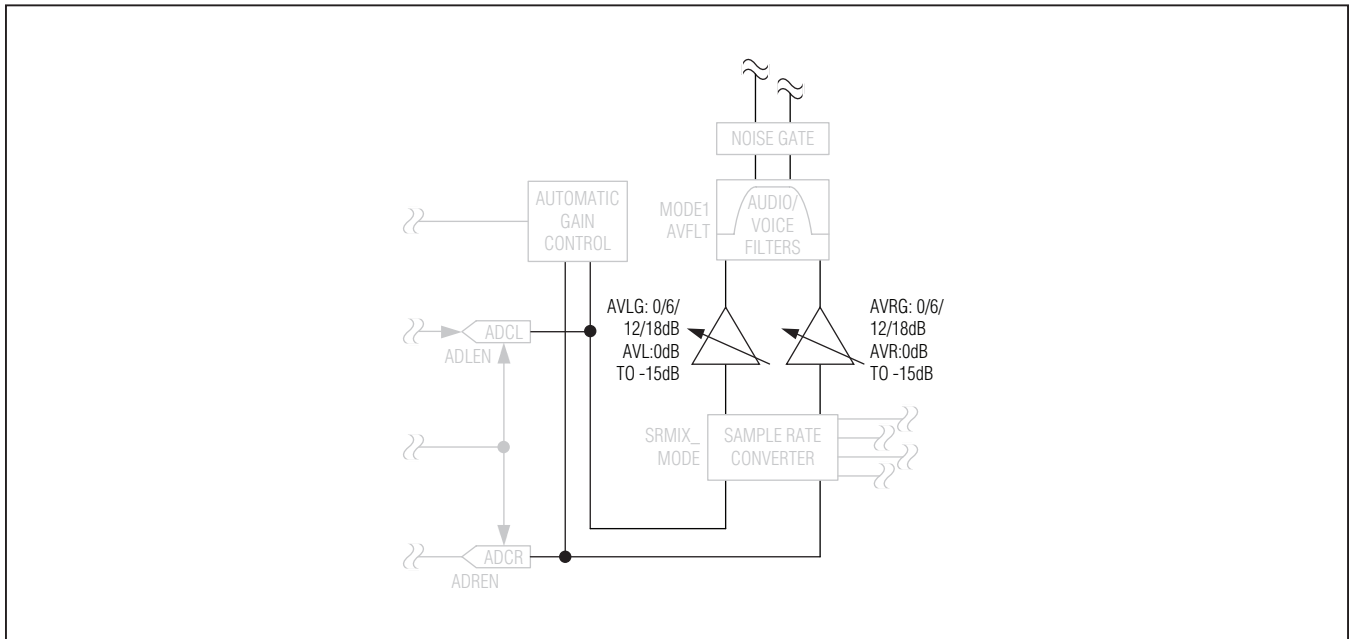

Figure 13. ADC Record Level Control Block Diagram

Stereo Audio Codec with FlexSound Technology

Table 7. ADC Record Level Control Register

REGISTER	BIT	NAME	DESCRIPTION			
0x33/0x34	5	AVLG/AVRG	Left/Right ADC Gain 00 = 0dB 01 = 6dB 10 = 12dB 11 = 18dB			
	4					
	3	AVL/AVR	Left/Right ADC Level			
			VALUE	GAIN (dB)	VALUE	GAIN (dB)
	2		0x0	+3	0x8	-5
			0x1	+2	0x9	-6
			0x2	+1	0xA	-7
	1		0x3	0	0xB	-8
			0x4	-1	0xC	-9
			0x5	-2	0xD	-10
			0x6	-3	0xE	-11
0	0x7	-4	0xF	-12		

Sidetone

Enable sidetone during full-duplex operation to add a low-level copy of the recorded audio signal to the playback audio signal (Figure 14). Sidetone is commonly used in telephony to allow the speaker to hear himself

speaking, providing a more natural user experience. The IC implements sidetone digitally. Doing so helps prevent unwanted feedback into the playback signal path and better matches the playback audio signal.

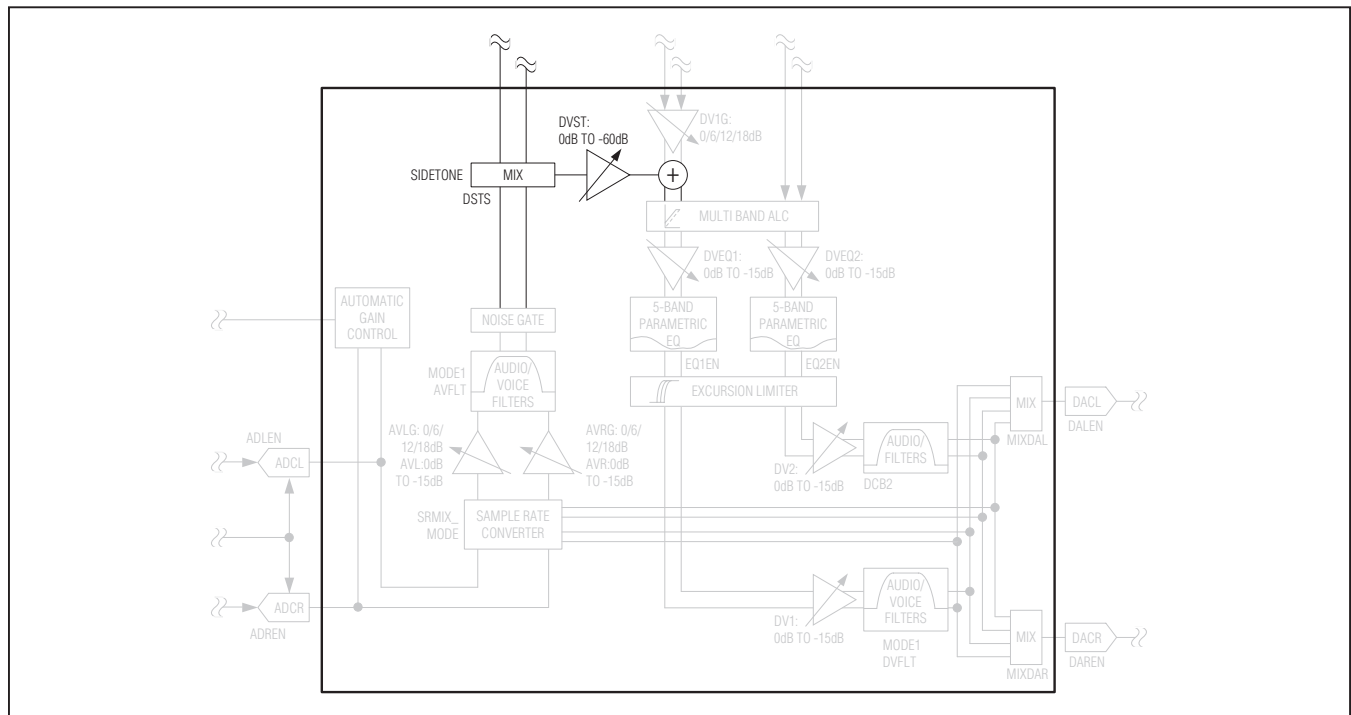

Figure 14. Sidetone Block Diagram

Stereo Audio Codec with FlexSound Technology

Table 8. Sidetone Register

REGISTER	BIT	NAME	DESCRIPTION				
0x2E	7	DSTS	Sidetone Source Selects which ADC output is fed back as sidetone. When mixing the left and right ADC outputs, each is attenuated by 6dB to prevent full-scale signals from clipping. 00 = Sidetone disabled 01 = Left ADC 10 = Right ADC 11 = Left + Right ADC				
	6						
	4	DVST	Sidetone Level Adjusts the sidetone signal level. All levels are referenced to the ADC's full-scale output.				
	3		VALUE	LEVEL (dB)	VALUE	LEVEL (dB)	
			0x00	Sidetone disabled	0x10	-30.5	
			0x01	-0.5	0x11	-32.5	
			0x02	-2.5	0x12	-34.5	
			0x03	-4.5	0x13	-36.5	
			0x04	-6.5	0x14	-38.5	
			2	0x05	-8.5	0x15	-40.5
				0x06	-10.5	0x16	-42.5
				0x07	-12.5	0x17	-44.5
				0x08	-14.5	0x18	-46.5
			1	0x09	-16.5	0x19	-48.5
				0x0A	-18.5	0x1A	-50.5
				0x0B	-20.5	0x1B	-52.5
				0x0C	-22.5	0x1C	-54.5
			0	0x0D	-24.5	0x1D	-56.6
				0x0E	-26.5	0x1E	-58.5
	0x0F			-28.5	0x1F	-60.5	

Digital Audio Interfaces

The IC includes two separate playback signal paths and one record signal path. Digital audio interface 1 (DAI1) is used to transmit the recorded stereo audio signal and receive a stereo audio signal for playback. Digital audio interface 2 (DAI2) is used to receive a second stereo audio signal. Use DAI1 for all full-duplex operations and for all voice signals. Use DAI2 for music and to mix two playback audio signals. The digital audio interfaces are separate from the audio ports to enable either interface to communicate with any external device connected to either audio port.

Each audio interface can be configured in a variety of formats including left justified, I²S, PCM, and time division multiplexed (TDM). TDM mode supports up to 4 mono audio slots in each frame. The IC can use up to 2 mono

slots per interface, leaving the remaining two slots available for another device. [Table 9](#) shows how to configure the device for common digital audio formats. [Figures 16](#) and [17](#) show examples of common audio formats. By default, SDOUTS1 and SDOUTS2 are set high impedance when the IC is not outputting data to facilitate sharing the bus. Configure the interface in TDM mode using only slot 1 to transmit and receive mono PCM voice data.

The IC's digital audio interfaces support both ADC to DAC loop-through and digital loopback. Loop-through allows the signal converted by the ADC to be routed to the DAC for playback. The signal is routed from the record path to the playback path in the digital audio interface to allow the IC's full complement of digital signal processing to be used. Loopback allows digital data input to either SDINS1 or SDINS2 to be routed from one interface to the

MAX98088

Stereo Audio Codec with FlexSound Technology

other for output on SDOUTS2 or SDOUTS1. Both interfaces must be configured for the same sample rate, but the interface format need not be the same. This allows

the IC to route audio data from one device to another, converting the data format as needed. [Figure 15](#) shows the available digital signal routing options.

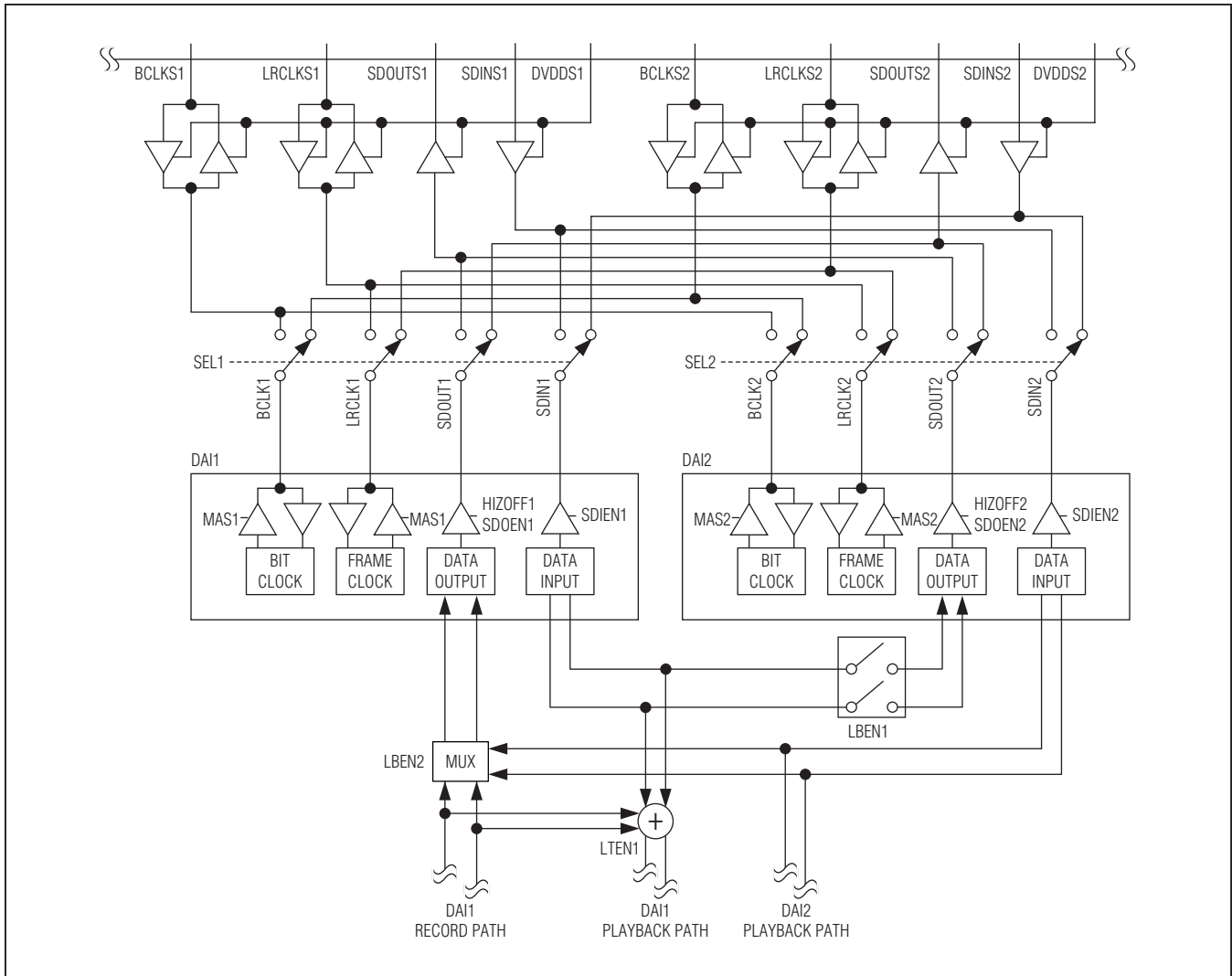

Figure 15. Digital Audio Signal Routing

Table 9. Common Digital Audio Formats

MODE	WC1/WC2	BC1/BC2	DLY1/DLY2	TDM1/TDM2	SLOT1/SLOT2	SLOT1R/SLOT2R
Left Justified	1	0	0	0	X	X
I ² S	0	0	1	0	X	X
PCM	X	1	X	1	0	0
TDM	X	1	X	1	Set as desired	

Stereo Audio Codec with FlexSound Technology

Table 10. Digital Audio Interface Registers

REGISTER	BIT	NAME	DESCRIPTION
0x14/0x1C	7	MAS1/MAS2	DAI1/DAI2 Master Mode In master mode, DAI1/DAI2 outputs LRCLK and BCLK. In slave mode, DAI1/DAI2 accept LRCLK and BCLK as inputs. 0 = Slave mode 1 = Master mode
	6	WCI1/WCI2	DAI1/DAI2 Word Clock Invert TDM1/TDM2 = 0: 0 = Left-channel data is transmitted while LRCLK is low. 1 = Right-channel data is transmitted while LRCLK is low. TDM1/TDM2 = 1: Always set WCI = 0.
	5	BCI1/BCI2	DAI1/DAI2 Bit Clock Invert BCI1/BCI2 must be set to 1 when TDM1/TDM2 = 1. 0 = SDIN is accepted on the rising edge of BCLK. SDOUT is valid on the rising edge of BCLK. 1 = SDIN is accepted on the falling edge of BCLK. SDOUT is valid on the falling edge of BCLK. Master Mode: 0 = LRCLK transitions on the falling edge of BCLK. 1 = LRCLK transitions on the rising edge of BCLK.
	4	DLY1/DLY2	DAI1/DAI2 Data Delay DLY1/DLY2 has no effect when TDM1/TDM2 = 1. 0 = The most significant data bit is clocked on the first active BCLK edge after an LRCLK transition. 1 = The most significant data bit is clocked on the second active BCLK edge after an LRCLK transition.
	2	TDM1/TDM2	DAI1/DAI2 Time-Division Multiplex Mode (TDM Mode) Set TDM1/TDM2 when communicating with devices that use a frame synchronization pulse on LRCLK instead of a square wave. 0 = Disabled 1 = Enabled (BCI1/BCI2 must be set to 1)
	1	FSW1/FSW2	DAI1/DAI2 Wide Frame Sync Pulse Increases the width of the frame sync pulse to the full data width when TDM1/TDM2 = 1. FSW1/FSW2 has no effect when TDM1/TDM2 = 0. 0 = Disabled 1 = Enabled
	0	WS1/WS2	DAI1/DAI2 Audio Data Bit Depth Determines the maximum bit depth of audio being transmitted and received. Data is always 16 bit when TDM1/TMD2 = 0. 0 = 16 bits 1 = 24 bits

Stereo Audio Codec with FlexSound Technology

Table 10. Digital Audio Interface Registers (continued)

REGISTER	BIT	NAME	DESCRIPTION
0x15/0x1D	7	OSR1	ADC Oversampling Ratio Use the higher setting for maximum performance. Use the lower setting for reduced power consumption at the expense of performance. 00 = 96x 01 = 64x 10 = Reserved 11 = Reserved
	6		
	5	DAC_OS1/ DAC_OS2	DAC Oversample Clock. Select PCLK/2 for higher performance. Select PCLK/4 for lower consumption. 1 = DAC input clock = PCLK/2 0 = DAC input clock = PCLK/4
	2	BSEL1/ BSEL2	DAI1/DAI2 BCLK Output Frequency When operating in master mode, BSEL1/BSEL2 set the frequency of BCLK. When operating in slave mode, BSEL1/BSEL2 have no effect. Select the lowest BCLK frequency that clocks all data input to the DAC and output by the ADC. 000 = BCLK disabled 001 = 64 x LRCLK 010 = 48 x LRCLK 011 = 128 x LRCLK (invalid for DHF1/DHF2 = 1) 100 = PCLK/2 101 = PCLK/4 110 = PCLK/8 111 = PCLK/16
1			
0			
0x16/0x1E	7	SEL1/SEL2	DAI1/DAI2 Audio Port Selector Selects which port is used by DAI1/DAI2. 00 = None 01 = Port S1 10 = Port S2 11 = Reserved
	6		
	5	LTEN1	DAI1 Digital Loopthrough Connects the output of the record signal path to the input of the playback path. Data input to DAI1 from an external device is mixed with the recorded audio signal. 0 = Disabled 1 = Enabled
	4	LBEN1/ LBEN2	DAI1/DAI2 Digital Audio Interface Loopback LBEN1 routes the digital audio input to DAI1 back out on DAI2. LBEN2 routes the digital audio input to DAI2 back out on DAI1. Selecting LBEN2 disables the ADC output data. 0 = Disabled 1 = Enabled
	3	DMONO1/ DMONO2	DAI1/DAI2 DAC Mono Mix Mixes the left and right digital input to mono and routes the combined signal to the left and right playback paths. The left and right input data is attenuated by 6dB prior to the mono mix. 0 = Disabled 1 = Enabled

Stereo Audio Codec with FlexSound Technology

Table 10. Digital Audio Interface Registers (continued)

REGISTER	BIT	NAME	DESCRIPTION
0x16/0x1E	2	HIZOFF1/ HIZOFF2	Disable DA1/DAI2 Output High-Impedance Mode Normally SDOOUT is set high impedance between data words. Set HIZOFF1/HIZOFF2 to force a level on SDOOUT at all times. 0 = Disabled 1 = Enabled
	1	SDOEN1/ SDOEN2	DAI1/DAI2 Record Path Output Enable DAI2 outputs data only if LBEN1 = 1. 0 = Disabled 1 = Enabled
	0	SDIEN1/ SDIEN2	DAI1/DAI2 Playback Path Input Enable 0 = Disabled 1 = Enabled
0x17/0x1F	7	SLOTL1/ SLOTL2	TDM Left Time Slot Selects which of the four slots is used for left data on DAI1/DAI2. If the same slot is selected for left and right audio, left audio is placed in the slot. 00 = Slot 1 01 = Slot 2 10 = Slot 3 11 = Slot 4
	6		
	5	SLOTR1/ SLOTR2	TDM Right Time Slot Selects which of the four slots is used for right data on DAI1/DAI2. If the same slot is selected for left and right audio, left audio is placed in the slot. 00 = Slot 1 01 = Slot 2 10 = Slot 3 11 = Slot 4
	4		
	3	SLOTDLY1/ SLOTDLY2	TDM Slot Delay Adds 1 BCLK cycle delay to the data in the specified TDM slot. 1xxx = Slot 4 delayed x1xx = Slot 3 delayed xx1x = Slot 2 delayed xxx1 = Slot 1 delayed
	2		
	1		
	0		

Stereo Audio Codec with FlexSound Technology

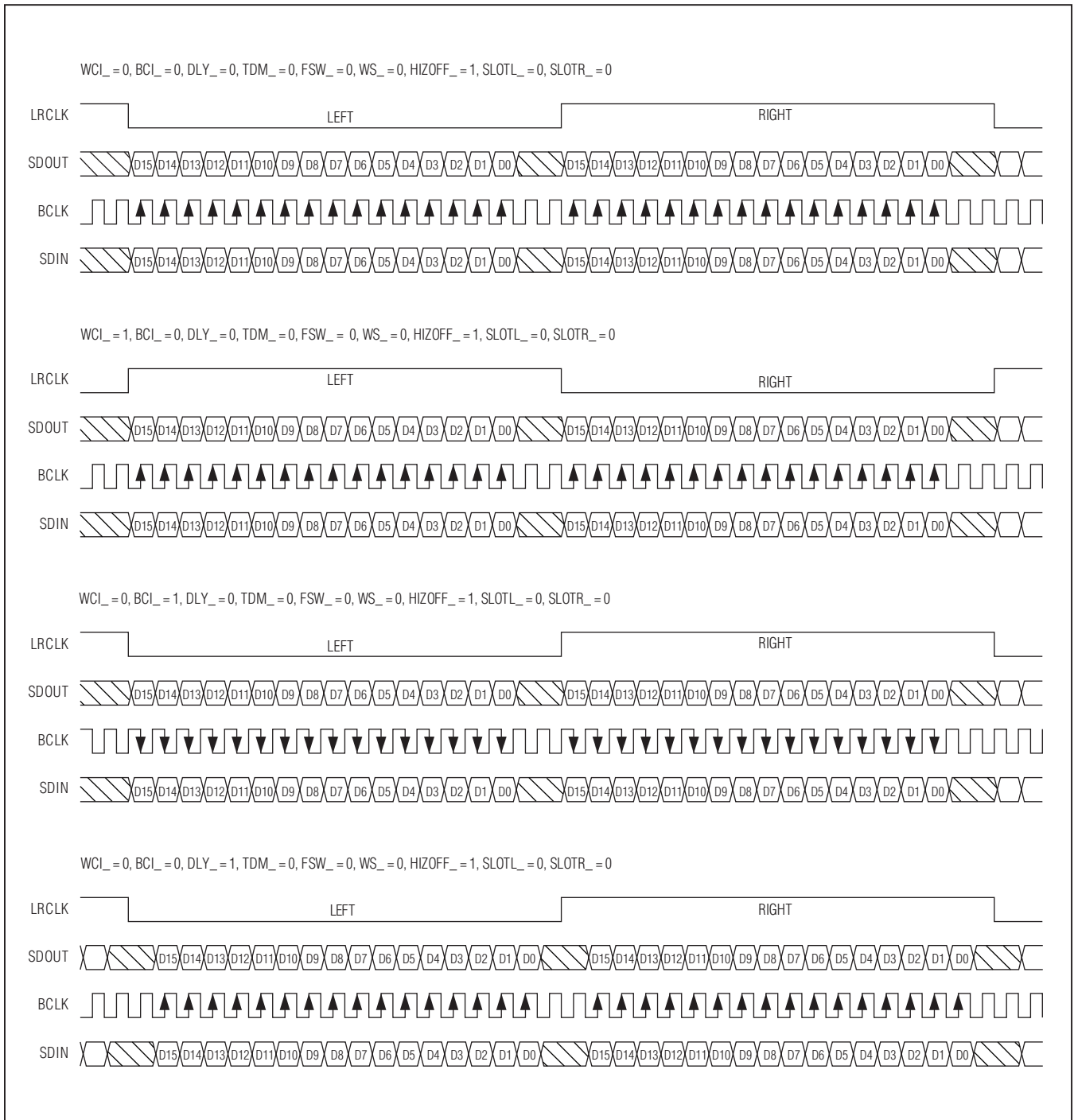

Figure 16. Non-TDM Data Format Examples

Stereo Audio Codec with FlexSound Technology

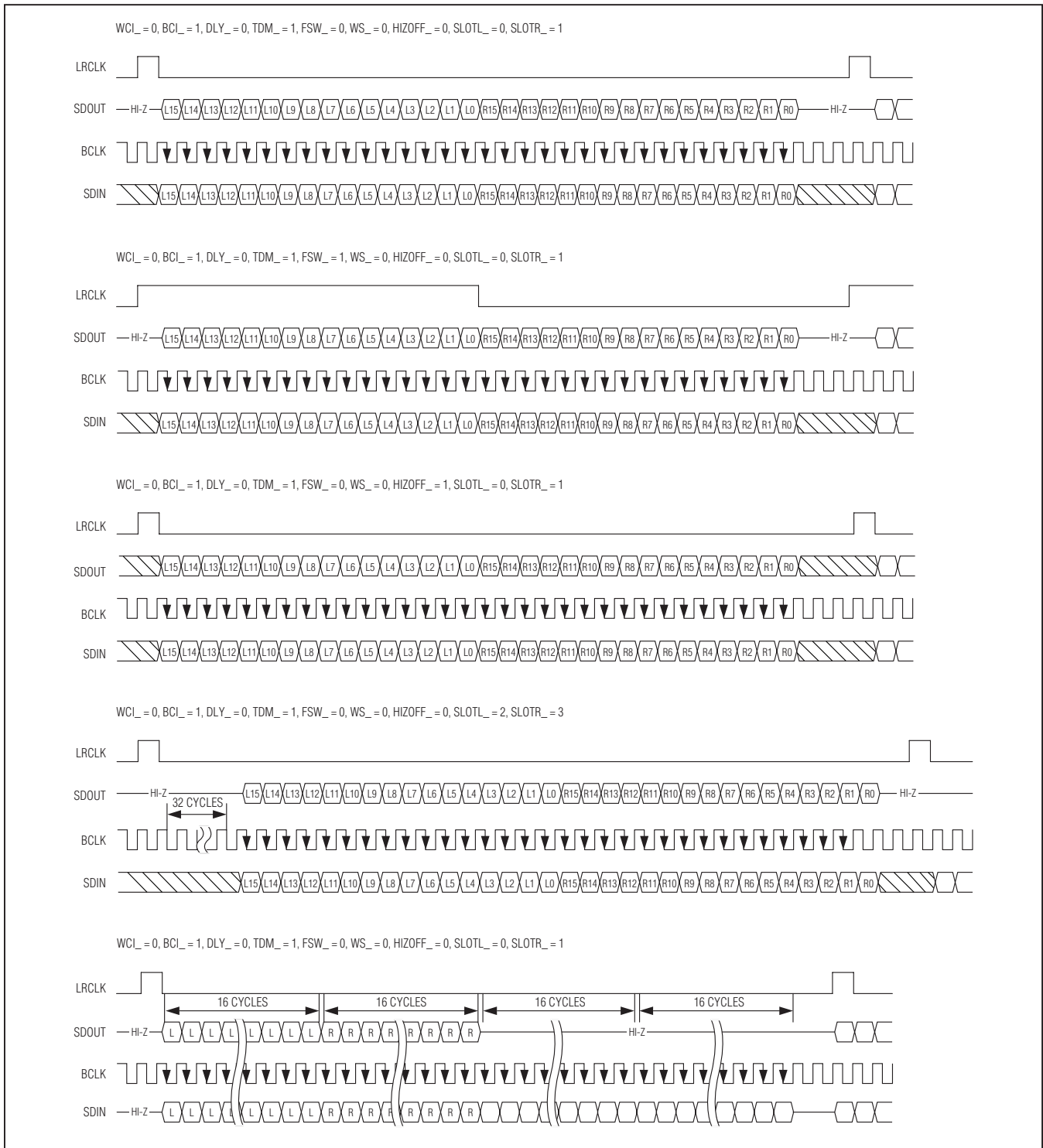

Figure 17. TDM Mode Data Format Examples

Stereo Audio Codec with FlexSound Technology

Clock Control

The digital signal paths in the IC require a master clock (MCLK) between 10MHz and 60MHz to function. The MAX98088 requires an internal clock between 10MHz and 20MHz. A prescaler divides MCLK by 1, 2, or 4 to create the internal clock (PCLK). PCLK is used to clock all portions of the IC.

The MAX98088 includes two digital audio signal paths, both capable of supporting any sample rate from 8kHz to 96kHz. Each path is independently configured to allow different sample rates. To accommodate a wide range of system architectures, four main clocking modes are supported:

- PLL Mode:** When operating in slave mode, enable the PLL to lock onto any LRCLK input. This mode requires the least configuration, but provides the lowest performance. Use this mode to simplify initial setup or when normal mode and exact integer mode cannot be used.
- Normal Mode:** This mode uses a 15-bit clock divider to set the sample rate relative to PCLK. This allows high flexibility in both the PCLK and LRCLK frequencies and can be used in either master or slave mode.
- Exact Integer Mode (DAI1 only):** In both master and slave modes, common MCLK frequencies (12MHz, 13MHz, 16MHz, and 19.2MHz) can be programmed to operate in exact integer mode for both 8kHz and 16kHz sample rates. In these modes, the MCLK and LRCLK rates are selected by using the FREQ1 bits instead of the NI, and PLL control bits.
- DAC Low-Power Mode:** This mode bypasses the PLL for reduce power consumptions and uses fixed counters to generate the clocks. The DAI_DAC_LP bits override the other clock settings.

Table 11. Clock Control Registers

REGISTER	BIT	NAME	DESCRIPTION																																				
0x10	5	PSCLK	MCLK Prescaler Generates PCLK, which is used by all internal circuitry. 00 = PCLK disabled 01 = 10MHz ≤ MCLK ≤ 20MHz (PCLK = MCLK) 10 = 20MHz ≤ MCLK ≤ 40MHz (PCLK = MCLK/2) 11 = 40MHz ≤ MCLK ≤ 60MHz (PCLK = MCLK/4)																																				
	4																																						
0x11/0x19	7	SR1/SR2	DAI1/DAI2 Sample Rate Used by the ALC to correctly set the dual-band crossover frequency and the excursion limiter to set the predefined corner frequencies.																																				
	6		<table border="1"> <thead> <tr> <th>VALUE</th> <th>SAMPLE RATE (kHz)</th> <th>VALUE</th> <th>SAMPLE RATE (kHz)</th> </tr> </thead> <tbody> <tr> <td>0x0</td> <td>Reserved</td> <td>0x8</td> <td>48</td> </tr> <tr> <td>0x1</td> <td>8</td> <td>0x9</td> <td>88.2</td> </tr> <tr> <td>0x2</td> <td>11.025</td> <td>0xA</td> <td>96</td> </tr> <tr> <td>0x3</td> <td>16</td> <td>0xB</td> <td>Reserved</td> </tr> <tr> <td>0x4</td> <td>22.05</td> <td>0xC</td> <td>Reserved</td> </tr> <tr> <td>0x5</td> <td>24</td> <td>0xD</td> <td>Reserved</td> </tr> <tr> <td>0x6</td> <td>32</td> <td>0xE</td> <td>Reserved</td> </tr> <tr> <td>0x7</td> <td>44.1</td> <td>0xF</td> <td>Reserved</td> </tr> </tbody> </table>	VALUE	SAMPLE RATE (kHz)	VALUE	SAMPLE RATE (kHz)	0x0	Reserved	0x8	48	0x1	8	0x9	88.2	0x2	11.025	0xA	96	0x3	16	0xB	Reserved	0x4	22.05	0xC	Reserved	0x5	24	0xD	Reserved	0x6	32	0xE	Reserved	0x7	44.1	0xF	Reserved
	VALUE		SAMPLE RATE (kHz)	VALUE	SAMPLE RATE (kHz)																																		
	0x0		Reserved	0x8	48																																		
	0x1		8	0x9	88.2																																		
	0x2		11.025	0xA	96																																		
	0x3		16	0xB	Reserved																																		
	0x4		22.05	0xC	Reserved																																		
	0x5		24	0xD	Reserved																																		
0x6	32	0xE	Reserved																																				
0x7	44.1	0xF	Reserved																																				
5																																							
4																																							

Stereo Audio Codec with FlexSound Technology

Table 11. Clock Control Registers (continued)

REGISTER	BIT	NAME	DESCRIPTION					
0x11	3	FREQ1	Exact Integer Mode Overrides PLL1 and NI1 and configures a specific PCLK to LRCLK ratio.					
			VALUE	SAMPLE RATE	VALUE	SAMPLE RATE		
	2		0x0	Disabled	0x8	PCLK = 12MHz, LRCLK = 8kHz		
			0x1	Reserved	0x9	PCLK = 12MHz, LRCLK = 16kHz		
			0x2	Reserved	0xA	PCLK = 13MHz, LRCLK = 8kHz		
			0x3	Reserved	0xB	PCLK = 13MHz, LRCLK = 16kHz		
			0x4	Reserved	0xC	PCLK = 16MHz, LRCLK = 8kHz		
			0x5	Reserved	0xD	PCLK = 16MHz, LRCLK = 16kHz		
			1	0x6	Reserved	0xE	PCLK = 19.2MHz, LRCLK = 8kHz	
				0x7	Reserved	0xF	PCLK = 19.2MHz, LRCLK = 16kHz	
0x12/0x1A	7	PLL1/PLL2	PLL Mode Enable (Slave Mode Only) PLL1/PLL2 enables a digital PLL that locks on to the externally supplied LRCLK frequency and automatically sets the LRCLK divider (NI1/NI2). 0 = Disabled 1 = Enabled					
	6 5 4 3 2 1 0	NI1/ NI2	Normal Mode LRCLK Divider When PLL1/PLL2 = 0, the frequency of LRCLK is determined by NI1/NI2. See Table 12 for common NI values.					
			SAMPLE RATE	DHF1/DHF2	NI1/NI2 FORMULA			
			8kHz ≤ LRCLK ≤ 48kHz	0				
			0x13/0x1B	7 6 5 4 3 2 1	NI1[0]/NI2[0]	48kHz < LRCLK ≤ 96kHz	1	
						f _{LRCLK} = LRCLK frequency f _{PCLK} = Prescaled MCLK frequency (PCLK)		
						Rapid Lock Mode Program NI1/NI2 to the nearest valid ratio and set NI1[0]/NI2[0] when PLL1/PLL2 = 1 to enable rapid lock mode. Normally, the PLL automatically calculates and dynamically adjusts NI1/NI2. When rapid lock mode is properly configured, the PLL starting point is much closer to the correct value, thus speeding up lock time. Wait one LRCLK period after programming NI1/NI2 before setting PLL1/PLL2 = 1.		

Stereo Audio Codec with FlexSound Technology

Table 11. Clock Control Registers (continued)

REGISTER	BIT	NAME	DESCRIPTION						
0x4F	7	DAI2_DAC_LP	DAI_ DAC Low Power Select. These bits setup the clocks to be generated from fixed counters that bypass the PLL for DAC low power mode.						
	6		VALUE	SETTING	FILTER SELECT	VALUE	SETTING	FILTER SELECT	
			0x0	PLL derived clock	—	0x8	PCLK = 2304 x LRCLK	Voice	
			0x1	PCLK = 128 x LRCLK	Audio 96kHz	0x9	Reserved	—	
			0x2	PCLK = 192 x LRCLK	Audio 96kHz	0xA	Reserved	—	
	3		DAI1_DAC_LP	0x3	PCLK = 256 x LRCLK	Audio 48kHz	0xB	Reserved	—
				0x4	PCLK = 384 x LRCLK	Audio 48kHz	0xC	Reserved	—
				0x5	PCLK = 768 x LRCLK	Voice	0xD	Reserved	—
				0x6	PCLK = 1152 x LRCLK	Voice	0xE	Reserved	—
				0x7	PCLK = 1536 x LRCLK	Voice	0xF	Reserved	—
0									
0x50	3	DAC2DITHEN	DAI2 DAC Input Dither Enable DAC2DITHEN is recommended to be set when DAI2_DAC_LP = 0000. 0 = Disabled 1 = Enabled						
	2	DAC1DITHEN	DAI1 DAC Input Dither 1 Enable DAC1DITHEN is recommended to be set when DAI1_DAC_LP = 0000. 0 = Disabled 1 = Enabled						
	1	CGM2_EN	DAI2 Clock Gen Module Enable CGM1_EN has to be set along with CGM2_EN to enable the clock generation for the DAI2 DAC playback path. 0 = Disabled 1 = Enabled						
	0	CGM1_EN	DAI1/Device Clock Gen Module Enable CGM1_EN enables the device clock generation, and needs to be set for DAC playback or ADC record. 0 = Disabled 1 = Enabled						

Stereo Audio Codec with FlexSound Technology

Table 12. Common NI1/NI2 Values

PCLK (MHz)	LRCLK (kHz)											
	DHF1/2 = 0						DHF1/2 = 1					
	8	11.025	12	16	22.05	24	32	44.1	48	64	88.2	96
10	13A9	1B18	1D7E	2752	3631	3AFB	4EA5	6C61	75F7	4EA5	6C61	75F7
11	11E0	18A2	1ACF	23BF	3144	359F	477E	6287	6B3E	477E	6287	6B3E
11.2896	116A	1800	1A1F	22D4	3000	343F	45A9	6000	687D	45A9	6000	687D
12	1062	1694	1893	20C5	2D29	3127	4189	5A51	624E	4189	5A51	624E
12.288	1000	160D	1800	2000	2C1A	3000	4000	5833	6000	4000	5833	6000
13	0F20	14D8	16AF	1E3F	29AF	2D5F	3C7F	535F	5ABE	3C7F	535F	5ABE
16	0C4A	10EF	126F	1893	21DE	24DD	3127	43BD	49BA	3127	43BD	49BA
16.9344	0B9C	1000	116A	1738	2000	22D4	2E71	4000	45A9	2E71	4000	45A9
18.432	0AAB	0EB3	1000	1555	1D66	2000	2AAB	3ACD	4000	2AAB	3ACD	4000
20	09D5	0D8C	0EBF	13A9	1B18	1D7E	2752	3631	3AFB	2752	3631	3AFB

Note: Values in bold are exact integers that provide maximum full-scale performance.

Sample Rate Converter

The sample rate conversion scheme enables the mixing of asynchronous audio data from the digital audio

interfaces (SDIN1/SDIN2), and for the resulting mixed audio to output on either audio interface through SDOUT1 or SDOUT2.

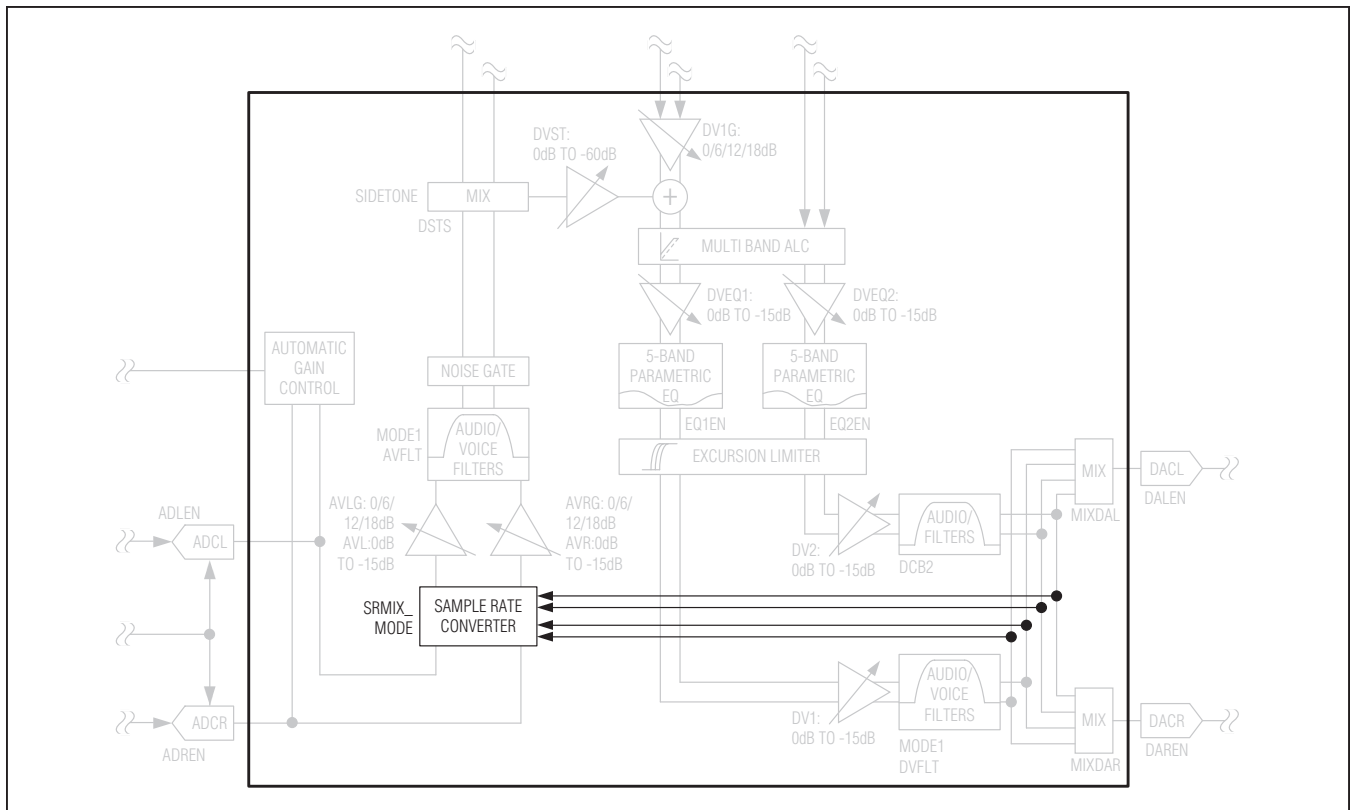

Figure 18. Sample Rate Converter

Stereo Audio Codec with FlexSound Technology

Table 13. Sample Rate Converter

REGISTER	BIT	NAME	DESCRIPTION
0x21	4	SRMIX_MODE	Sample Rate Mix Mode. Sets mixing configuration applied to the sample rate converted channel(s). 0 = (DAI1 + DAI2) 1 = (DAI1 + DAI2)/2
	3	SRMIX_ENL	Sample Rate Mix Enable. If enabled, mixes data on DAI1 and DAI2. If cleared, SCR data source is DAI2 only. 0 = SRC mix disable 1 = SRC mix enable
	2	SRMIX_ENR	
	1	SRC_ENL	Sample Rate Converter Enable. Select if the SRC is enabled on per channel basis. 0 = Sample rate converter disable 1 = Sample rate converter enable
	0	SRC_ENR	

Passband Filtering

Each digital signal path in the IC includes options for defining the path bandwidth (Figure 19). The playback and record paths connected to DAI1 support both voice and music filtering while the playback path connected to DAI2 supports music filtering only.

The voice IIR filters provide greater than 70dB stopband attenuation at frequencies above $f_s/2$ to reduce aliasing. Three selectable highpass filters eliminate unwanted low-frequency signals.

Use music mode when processing high-fidelity audio content. The music FIR filters reduce power consumption and are linear phase to maintain stereo imaging. An optional DC-blocking filter is available to eliminate unwanted DC offset.

In music mode, a second set of FIR filters are available to support sample rates greater than 50kHz. The filters can be independently selected for DAI1 and DAI2 and support both the playback and record audio paths.

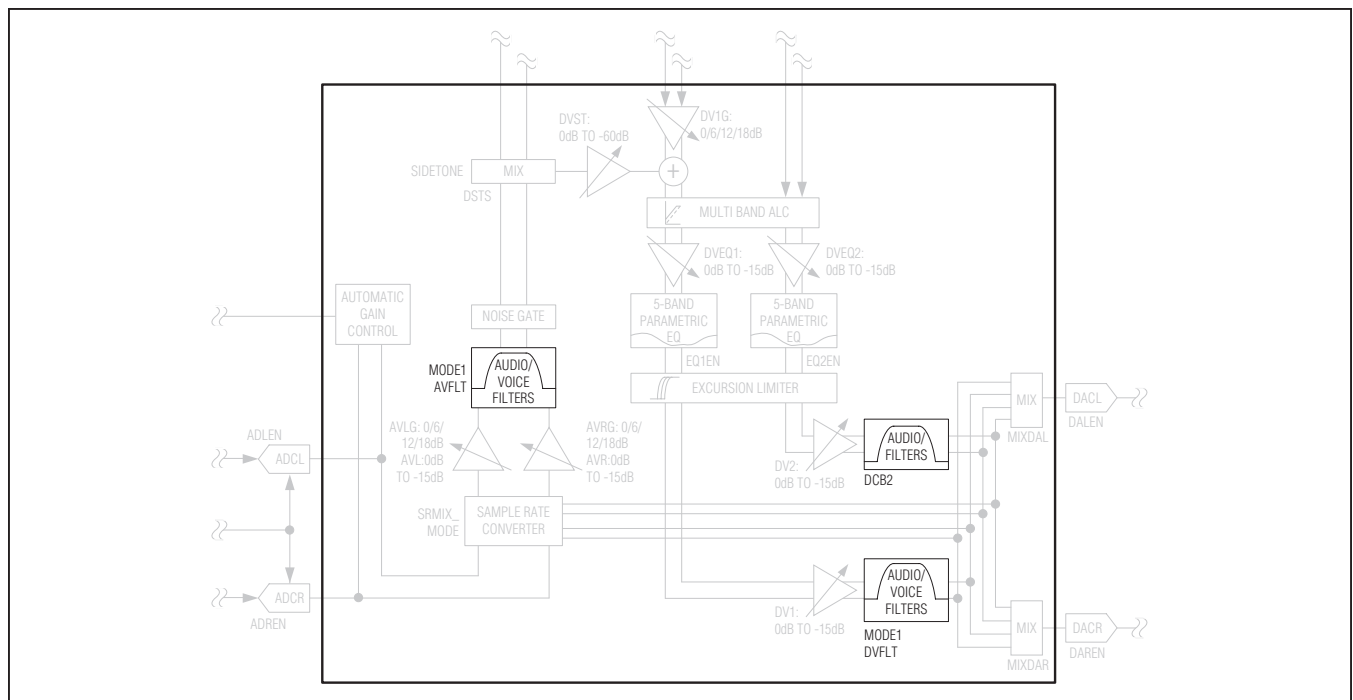

Figure 19. Digital Passband Filtering Block Diagram

Stereo Audio Codec with FlexSound Technology

Table 14. Passband Filtering Registers

REGISTER	BIT	NAME	DESCRIPTION	
0x18	7	MODE1	DAI1 Passband Filtering Mode 0 = Voice filters 1 = Music filters (recommended for $f_S > 24\text{kHz}$)	
	6	AVFLT1	DAI1 ADC Highpass Filter Mode	
	5		MODE1	AVFLT1
	4		0	See Table 15
			1	Select a nonzero value to enable the DC-blocking filter.
	3	DHF1	DAI1 High Sample Rate Mode Selects the sample rate range. 0 = $8\text{kHz} \leq \text{LRCLK} \leq 48\text{kHz}$ 1 = $48\text{kHz} \leq \text{LRCLK} \leq 96\text{kHz}$	
	2	DVFLT1	DAI1 DAC Highpass Filter Mode	
	1		MODE1	DVFLT1
0	0		See Table 15	
0x20	3	DHF2	DAI2 High Sample Rate Mode Selects the sample rate range. 0 = $8\text{kHz} \leq \text{LRCLK} \leq 48\text{kHz}$ 1 = $48\text{kHz} < \text{LRCLK} \leq 96\text{kHz}$	
			0	DAI2 DC Blocking Filter Enables a DC-blocking filter on the DAI2 playback audio path. 0 = Disabled 1 = Enabled

Stereo Audio Codec with FlexSound Technology

Table 15. Voice Highpass Filters

AVFTL/DVFLT VALUE	INTENDED SAMPLE RATE	FILTER RESPONSE
000	N/A	Disabled
001/011	16kHz/8kHz	
010/100	16kHz/8kHz	
101	8kHz to 48kHz	
110/111	N/A	Reserved

Stereo Audio Codec with FlexSound Technology

Playback Path Signal Processing

The IC playback signal path includes automatic level control (ALC) and a 5-band parametric equalizer (EQ) (Figure 20). The DAI1 and DAI2 playback paths include separate ALCs controlled by a single set of registers. Two completely separate parametric EQs are included for the DAI1 and DAI2 playback paths.

Automatic Level Control

The automatic level control (ALC) circuit ensures maximum signal amplitude without producing audible clipping. This is accomplished by a variable gain stage that works on a sample by sample basis to increase the gain up to 12dB. A look-ahead circuit determines if the next sample exceeds full scale and reduces the gain so that the sample is exactly full scale.

A programmable low signal threshold determines the minimum signal amplitude that is amplified. Select a threshold that prevents the amplification of background noise. When the signal level drops below the low signal threshold, the ALC reduces the gain to 0dB until the signal increases above the threshold. Figure 21 shows an example of ALC input vs. output curves.

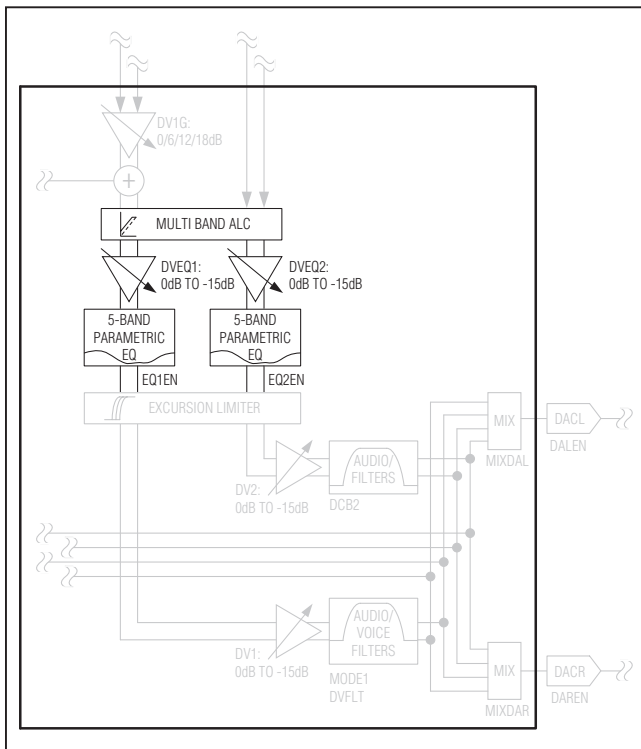

Figure 20. Playback Path Signal Processing Block Diagram

The ALC can optionally be configured in dual-band mode. In this mode, the input signal is filtered into two bands with a 5kHz center frequency. Each band is routed through independent ALCs and then summed together. In multiband mode, both bands use the same parameters.

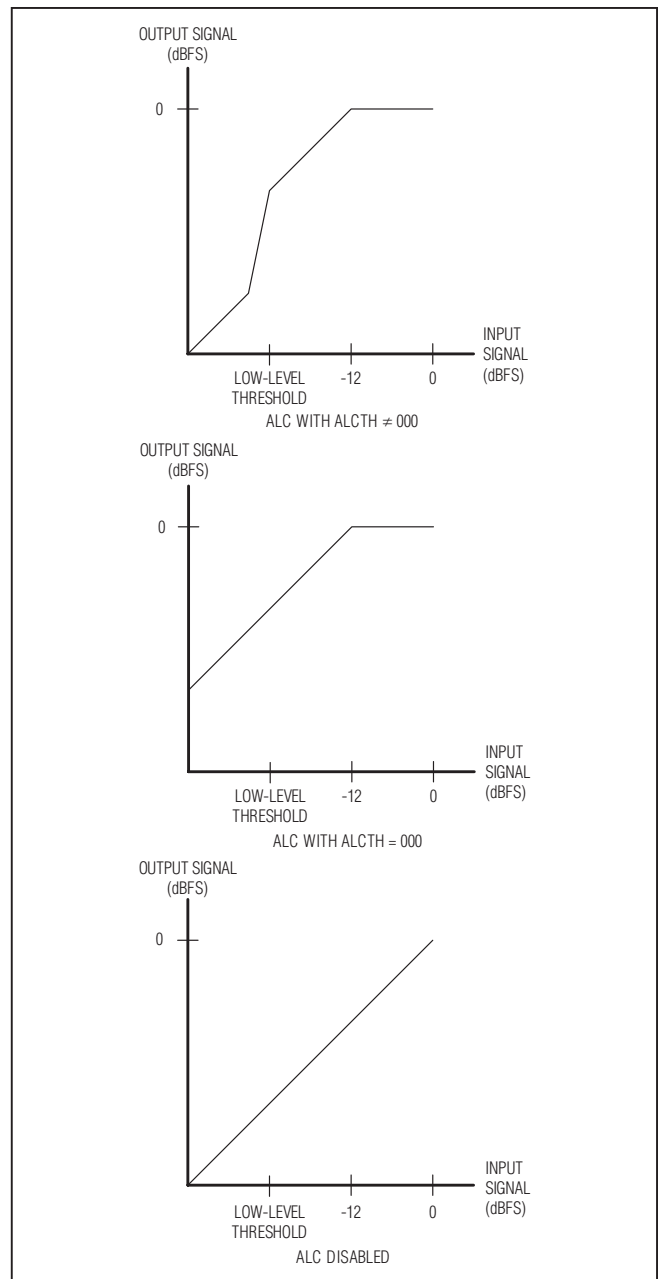

Figure 21. ALC Input vs. Output Examples

Stereo Audio Codec with FlexSound Technology

Table 16. Automatic Level Control Registers

REGISTER	BIT	NAME	DESCRIPTION	
0x43	7	ALCEN	ALC Enable Enables ALC on both the DAI1 and DAI2 playback paths. 0 = Disabled 1 = Enabled	
	6	ALCRLS	ALC and Excursion Limiter Release Time Sets the release time for both the ALC and Excursion Limiter. See the <i>Excursion Limiter</i> section for Excursion Limiter release times. ALC release time is defined as the time required to adjust the gain from 12dB to 0dB.	
	5		VALUE	ALC RELEASE TIME (s)
			000	8
			001	4
			010	2
			011	1
			100	0.5
			101	0.25
			110	Reserved
	111	Reserved		
	3	ALCMB	Multiband Enable Enables dual-band processing with a 5kHz center frequency. SR1 and SR2 must be configured properly to achieve the correct center frequency for each playback path. 0 = Single-band ALC 1 = Dual-band ALC	
	2	ALCTH	Low Signal Threshold Selects the minimum signal level to be boosted by the ALC. 000 = $-\infty$ dB (low-signal threshold disabled) 001 = -12dB 010 = -18dB 011 = -24dB 100 = -30dB 101 = -36dB 110 = -42dB 111 = -48dB	
	1			
0				

Parametric Equalizer

The parametric EQ contains five independent biquad filters with programmable gain, center frequency, and bandwidth. Each biquad filter has a gain range of ± 12 dB and a center frequency range from 20Hz to 20kHz. Use a filter Q less than that shown in [Figure 22](#) to achieve ideal frequency responses. Setting a higher Q results in non-ideal frequency response. The biquad filters are series connected, allowing a total gain of ± 60 dB.

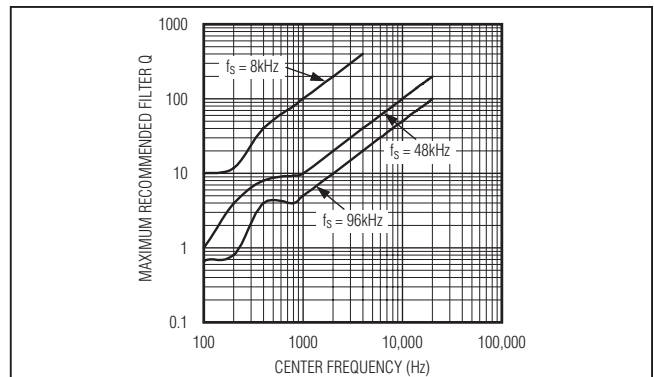

Figure 22. Maximum Recommended Filter Q vs. Frequency

Stereo Audio Codec with FlexSound Technology

Use the attenuator at the EQ's input to avoid clipping the signal. The attenuator can be programmed for fixed attenuation or dynamic attenuation based on signal level. If the dynamic EQ clip detection is enabled, the signal level from the EQ is fed back to the attenuator circuit to determine the amount of gain reduction necessary to avoid clipping.

The MAX98088 EV kit software includes a graphical interface for generating the EQ coefficients. The coefficients are sample rate dependent and stored in registers 0x52 through 0xB5.

Table 17. EQ Registers

REGISTER	BIT	NAME	DESCRIPTION																																				
0x30/0x32	4	$\overline{\text{EQCLP1}}$ / $\overline{\text{EQCLP2}}$	DAI1/DAI2 EQ Clip Detection Automatically controls the EQ attenuator to prevent clipping in the EQ. 0 = Enabled 1 = Disabled																																				
	3	DVEQ1/DVEQ2	DAI1/DAI2 EQ Attenuator Provides attenuation to prevent clipping in the EQ when full-scale signals are boosted. DVEQ1/DVEQ2 operates only when EQ1EN/EQ2EN = 1 and $\overline{\text{EQCLP1}}$ / $\overline{\text{EQCLP2}}$ = 1.																																				
	2		<table border="1"> <thead> <tr> <th>VALUE</th> <th>GAIN (dB)</th> <th>VALUE</th> <th>GAIN (dB)</th> </tr> </thead> <tbody> <tr> <td>0x0</td> <td>0</td> <td>0x8</td> <td>-8</td> </tr> <tr> <td>0x1</td> <td>-1</td> <td>0x9</td> <td>-9</td> </tr> <tr> <td>0x2</td> <td>-2</td> <td>0xA</td> <td>-10</td> </tr> <tr> <td>0x3</td> <td>-3</td> <td>0xB</td> <td>-11</td> </tr> <tr> <td>0x4</td> <td>-4</td> <td>0xC</td> <td>-12</td> </tr> <tr> <td>0x5</td> <td>-5</td> <td>0xD</td> <td>-13</td> </tr> <tr> <td>0x6</td> <td>-6</td> <td>0xE</td> <td>-14</td> </tr> <tr> <td>0x7</td> <td>-7</td> <td>0xF</td> <td>-15</td> </tr> </tbody> </table>	VALUE	GAIN (dB)	VALUE	GAIN (dB)	0x0	0	0x8	-8	0x1	-1	0x9	-9	0x2	-2	0xA	-10	0x3	-3	0xB	-11	0x4	-4	0xC	-12	0x5	-5	0xD	-13	0x6	-6	0xE	-14	0x7	-7	0xF	-15
	VALUE		GAIN (dB)	VALUE	GAIN (dB)																																		
	0x0		0	0x8	-8																																		
	0x1		-1	0x9	-9																																		
	0x2		-2	0xA	-10																																		
	0x3		-3	0xB	-11																																		
	0x4		-4	0xC	-12																																		
	0x5		-5	0xD	-13																																		
0x6	-6	0xE	-14																																				
0x7	-7	0xF	-15																																				
1																																							
0																																							
0x49	7	$\overline{\text{VS2EN}}$	See the <i>Click-and-Pop Reduction</i> section.																																				
	6	$\overline{\text{VSEN}}$																																					
	5	$\overline{\text{ZDEN}}$																																					
	1	EQ2EN	DAI2 EQ Enable 0 = Disabled 1 = Enabled																																				
	0	EQ1EN	DAI1 EQ Enable 0 = Disabled 1 = Enabled																																				

MAX98088

Stereo Audio Codec with FlexSound Technology

Playback Level Control

The IC includes separate digital level control for the DAI1 and DAI2 playback audio paths. The DAI1 signal path

allows boost when MODE1 = 0 and attenuation in any mode. The DAI2 signal path allows attenuation only.

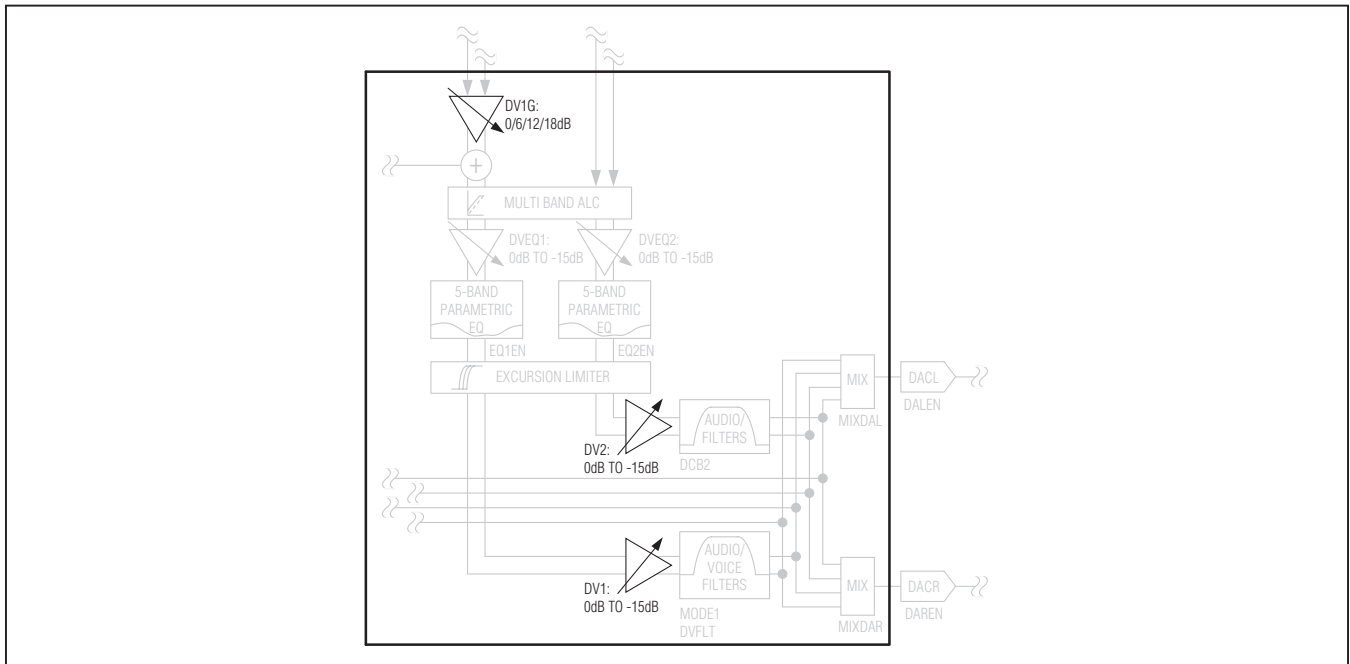

Figure 23. Playback Level Control Block Diagram

Table 18. DAC Playback Level Control Register

REGISTER	BIT	NAME	DESCRIPTION			
0x2F/0x31	7	DV1M/DV2M	DAI1/DAI2 Mute 0 = Disabled 1 = Enabled			
	5	DV1G	DAI1 Voice Mode Gain DV1G only applies when MODE1 = 0. 00 = 0dB 01 = 6dB 10 = 12dB 11 = 18dB			
	4					
	3	DV1/DV2	DAI1/DAI2 Attenuation			
			VALUE	GAIN (dB)	VALUE	GAIN (dB)
	2		0x0	0	0x8	-8
			0x1	-1	0x9	-9
	1		0x2	-2	0xA	-10
			0x3	-3	0xB	-11
			0x4	-4	0xC	-12
0x5		-5	0xD	-13		
0	0x6	-6	0xE	-14		
	0x7	-7	0xF	-15		

MAX98088

Stereo Audio Codec with FlexSound Technology

DAC Input Mixers

The IC's stereo DAC accepts input from two digital audio paths. The DAC mixer routes any audio path to the left and right DACs (Figure 24).

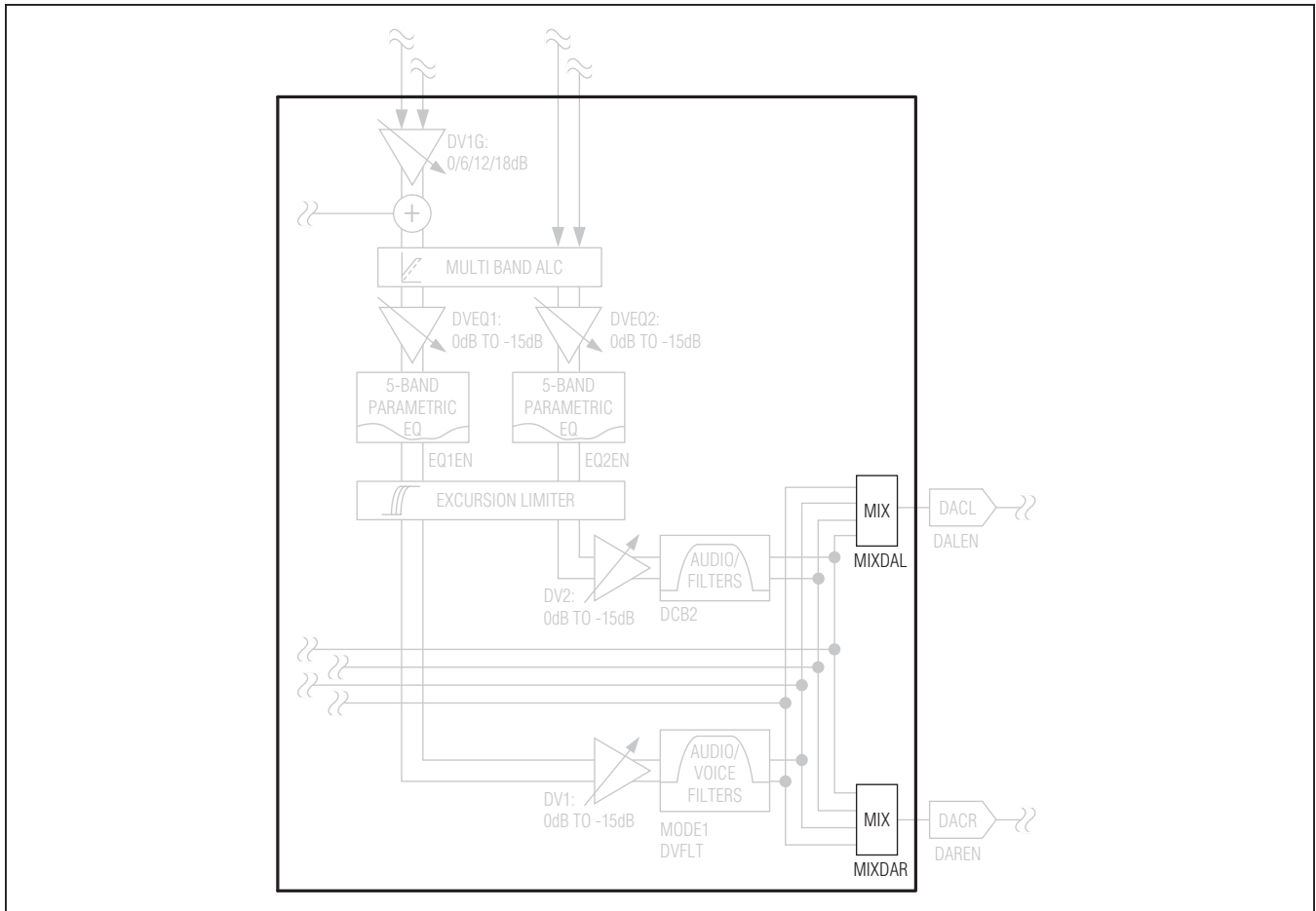

Figure 24. DAC Input Mixer Block Diagram

Table 19. DAC Input Mixer Register

REGISTER	BIT	NAME	DESCRIPTION
0x22	7	MIXDAL	Left DAC Input Mixer 1xxx = DAI1 left channel x1xx = DAI1 right channel xx1x = DAI2 left channel xxx1 = DAI2 right channel
	6		
	5		
	4		
	3	MIXDAR	Right DAC Input Mixer 1xxx = DAI1 left channel x1xx = DAI1 right channel xx1x = DAI2 left channel xxx1 = DAI2 right channel
	2		
	1		
	0		

MAX98088

Stereo Audio Codec with FlexSound Technology

Receiver Amplifier

The IC includes a single differential receiver amplifier. The receiver amplifier is designed to drive a 32Ω earpiece speaker. In cases where a single transducer is used for the loudspeaker and receiver, use the SPKBYP switch to route the receiver amplifier output to the left speaker outputs. The receiver amplifier can also be configured as stereo single-ended line outputs using the I²C interface.

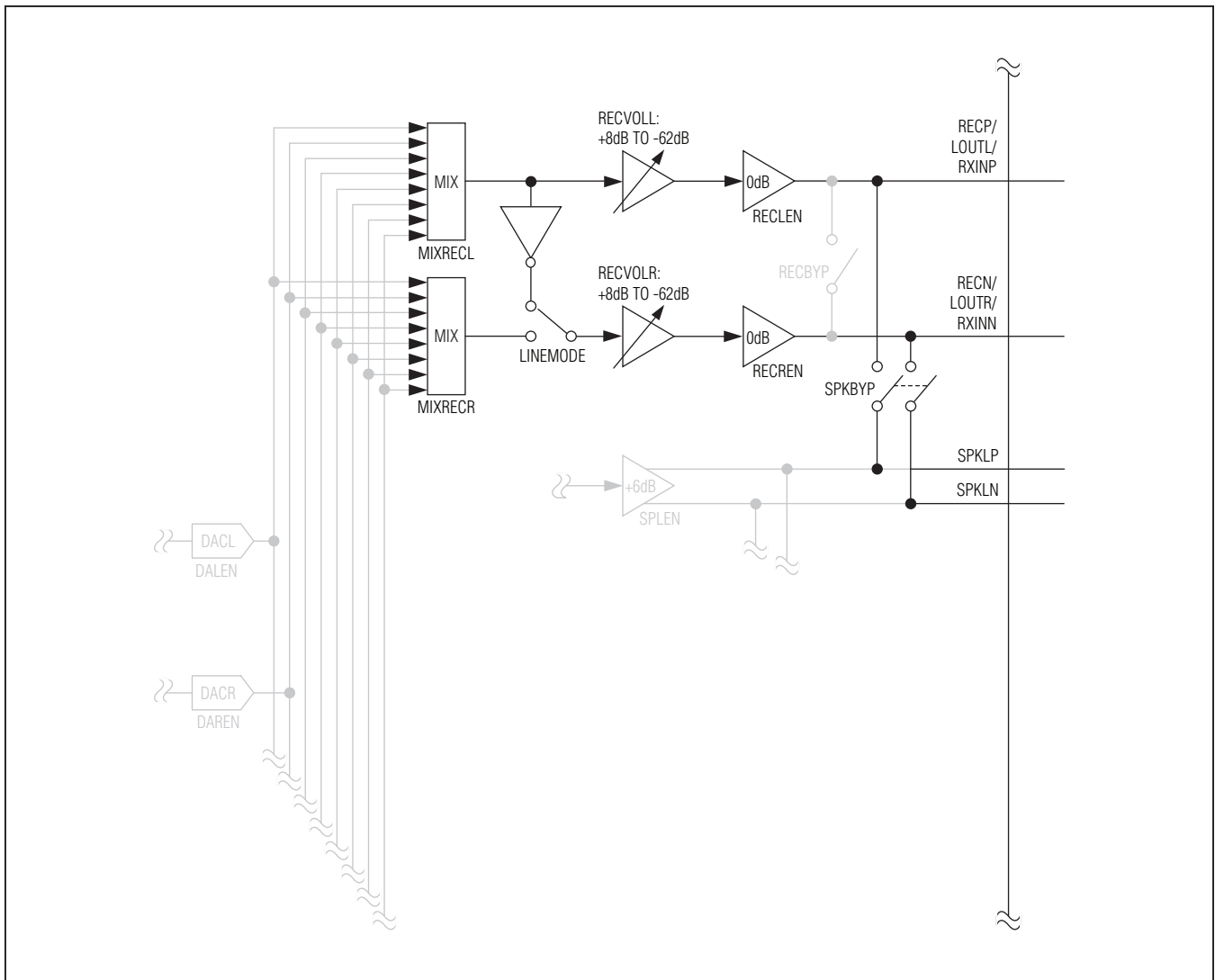

Figure 25. Receiver Amplifier Block Diagram

MAX98088

Stereo Audio Codec with FlexSound Technology

Receiver Output Mixer

The IC's receiver amplifier accepts input from the stereo DAC, the line inputs (single-ended or differential), and the MIC inputs. Configure the mixer to mix any combination of the available sources. When more than one signal is selected, the mixed signal can be configured to attenuate 6dB, 9dB, or 12dB.

Table 20. Receiver Output Mixer Register

REGISTER	BIT	NAME	DESCRIPTION
0x28	7	MIXRECL	Left Receiver Output Mixer 1xxxxxxx = Right DAC x1xxxxxx = MIC2 xx1xxxxx = MIC1 xxx1xxxx = INB2 (INBDIFF = 0) or INB2-INB1 (INBDIFF = 1) xxxx1xxx = INB1 xxxxx1xx = INA2 (INADIFF = 0) or INA2-INA1 (INADIFF = 1) xxxxxx1x = INA1 xxxxxxx1 = Left DAC
	6		
	5		
	4		
	3		
	2		
	1		
	0		
0x29	7	MIXRECR	Right Receiver Output Mixer 1xxxxxxx = Left DAC x1xxxxxx = MIC2 xx1xxxxx = MIC1 xxx1xxxx = INB2 (INBDIFF = 0) or INB2-INB1 (INBDIFF = 1) xxxx1xxx = INB1 xxxxx1xx = INA2 (INADIFF = 0) or INA2-INA1 (INADIFF = 1) xxxxxx1x = INA1 xxxxxxx1 = Right DAC
	6		
	5		
	4		
	3		
	2		
	1		
	0		
0x2A	7	LINE_MODE	Receiver Output Mode. Configures receive path output mode between BTL and stereo line output. 0 = BTL 1 = Stereo line output
	3	MIXRECR_GAIN	Right Receiver Mixer Gain Select 00 = 0dB 01 = -6dB 10 = -9dB 11 = -12dB
	2		
	1	MIXRECL_GAIN	Left Receiver Mixer Gain Select 00 = 0dB 01 = -6dB 10 = -9dB 11 = -12dB
	0		
	0		

Stereo Audio Codec with FlexSound Technology

Receiver Output Volume

Table 21. Receiver Output Level Register

REGISTER	BIT	NAME	DESCRIPTION			
0x3B/0x3C	7	RECLM/ RECRM	Receiver Output Mute 0 = Disabled 1 = Enabled			
	4	RECVOLL/ RECVOLR	Receiver Output Volume Level			
	3		VALUE	VOLUME (dB)	VALUE	VOLUME (dB)
			0x00	-62	0x10	-10
			0x01	-58	0x11	-8
	2		0x02	-54	0x12	-6
			0x03	-50	0x13	-4
			0x04	-46	0x14	-2
			0x05	-42	0x15	0
			0x06	-38	0x16	+1
	1		0x07	-35	0x17	+2
			0x08	-32	0x18	+3
			0x09	-29	0x19	+4
			0x0A	-26	0x1A	+5
			0x0B	-23	0x1B	+6
	0		0x0C	-20	0x1C	+6.5
			0x0D	-17	0x1D	+7
0x0E			-14	0x1E	+7.5	
0x0F		-12	0x1F	+8		

Stereo Audio Codec with FlexSound Technology

Speaker Amplifiers

The IC integrates a stereo filterless Class D amplifier that offers much higher efficiency than Class AB without the typical disadvantages.

The high efficiency of a Class D amplifier is due to the switching operation of the output stage transistors. In a Class D amplifier, the output transistors act as current steering switches and consume negligible additional power. Any power loss associated with the Class D output stage is mostly due to the I^2R loss of the MOSFET on-resistance, and quiescent current overhead.

The theoretical best efficiency of a linear amplifier is 78%, however, that efficiency is only exhibited at peak output power. Under normal operating levels (typical music reproduction levels), efficiency falls below 30%, whereas the IC's Class D amplifier still exhibits 80% efficiency under the same conditions.

Traditional Class D amplifiers require the use of external LC filters or shielding to meet EN55022B and FCC electromagnetic-interference (EMI) regulation standards. Maxim's patented active emissions limiting edge-rate control circuitry reduces EMI emissions, allowing operation without any output filtering in typical applications.

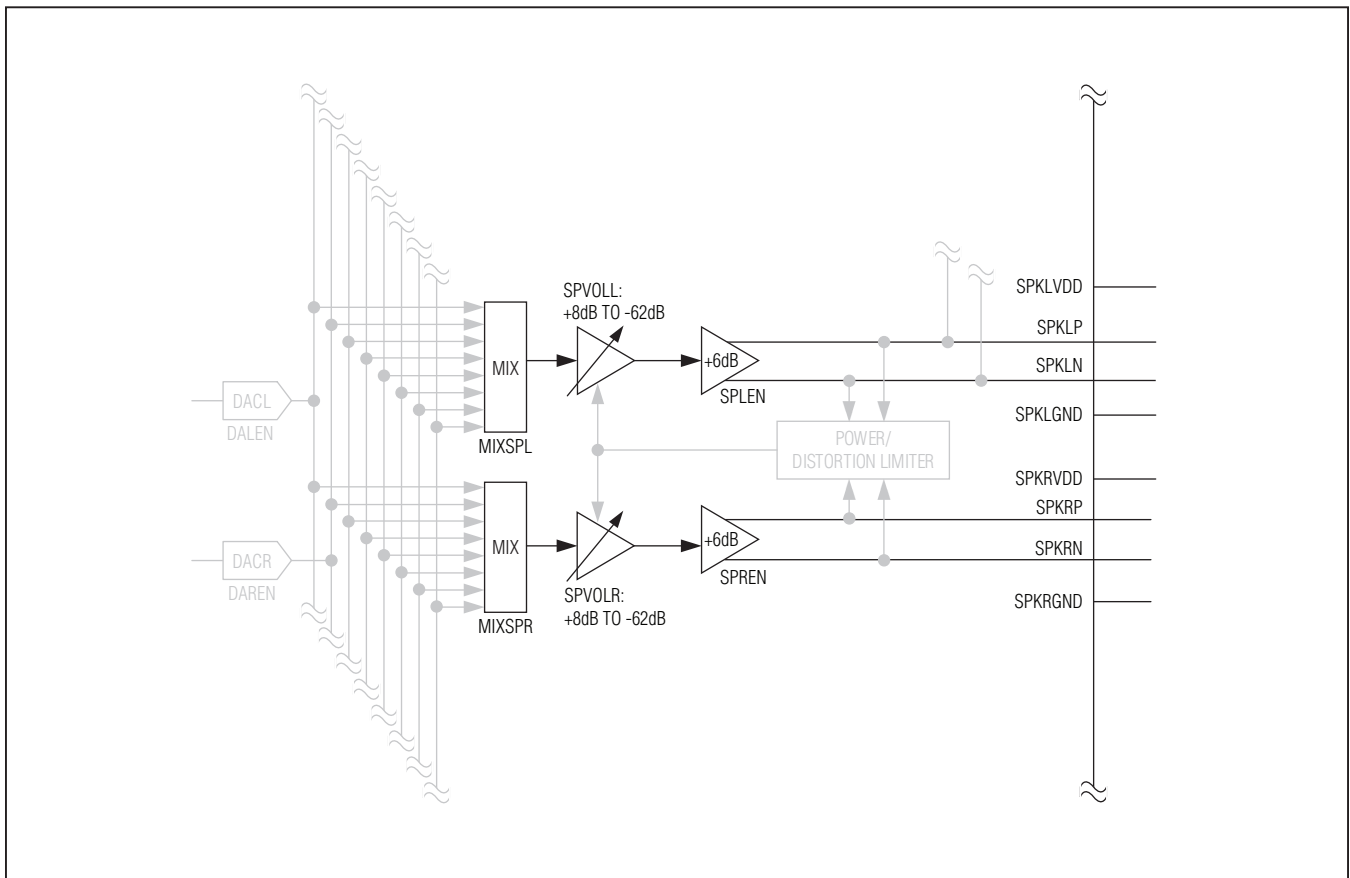

Figure 26. Speaker Amplifier Path Block Diagram

MAX98088

Stereo Audio Codec with FlexSound Technology

Speaker Output Mixers

The IC's speaker amplifiers accept input from the stereo DAC, the line inputs (single-ended or differential), and the MIC inputs. Configure the mixer to mix any combination of the available sources. When more than one signal is selected, the mixer can be configured to attenuate the signal by 6dB, 9dB or 12dB.

Table 22. Speaker Output Mixer Register

REGISTER	BIT	NAME	DESCRIPTION	
0x2B	7	MIXSPL	Left Speaker Output Mixer 1xxxxxxx = Right DAC x1xxxxxx = MIC2 xx1xxxxx = MIC1 xxx1xxxx = INB2 (INBDIFF = 0) or INB2-INB1 (INBDIFF = 1) xxxx1xxx = INB1 xxxxx1xx = INA2 (INADIFF = 0) or INA2-INA1 (INADIFF = 1) xxxxxx1x = INA1 xxxxxxx1 = Left DAC	
	6			
	5			
	4			
	3			
	2			
	1			
	0			
0x2C	7	MIXSPR	Right Speaker Output Mixer 1xxxxxxx = Left DAC x1xxxxxx = MIC2 xx1xxxxx = MIC1 xxx1xxxx = INB2 (INBDIFF = 0) or INB2-INB1 (INBDIFF = 1) xxxx1xxx = INB1 xxxxx1xx = INA2 (INADIFF = 0) or INA2-INA1 (INADIFF = 1) xxxxxx1x = INA1 xxxxxxx1 = Right DAC	
	6			
	5			
	4			
	3			
	2			
	1			
	0			
0x2D	3	MIXSPR _GAIN	Right Speaker Mixer Gain Select 00 = 0dB 01 = -6dB 10 = -9dB 11 = -12dB	
	2			
	1	MIXSPL _GAIN		Left Speaker Mixer Gain Select 00 = 0dB 01 = -6dB 10 = -9dB 11 = -12dB
	0			

Stereo Audio Codec with FlexSound Technology

Speaker Output Volume

Table 23. Speaker Output Level Register

REGISTER	BIT	NAME	DESCRIPTION			
0x3D/0x3E	7	SPLM/SPRM	Left/Right Speaker Output Mute 0 = Disabled 1 = Enabled			
	4	SPVOLL/SPVOLR	Left/Right Speaker Output Volume Level			
			VALUE	VOLUME (dB)	VALUE	VOLUME (dB)
			0x00	-62	0x10	-10
			0x01	-58	0x11	-8
	3		0x02	-54	0x12	-6
			0x03	-50	0x13	-4
			0x04	-46	0x14	-2
			0x05	-42	0x15	0
			0x06	-38	0x16	+1
			0x07	-35	0x17	+2
	2		0x08	-32	0x18	+3
			0x09	-29	0x19	+4
			0x0A	-26	0x1A	+5
			0x0B	-23	0x1B	+6
			0x0C	-20	0x1C	+6.5
	1		0x0D	-17	0x1D	+7
0x0E			-14	0x1E	+7.5	
0x0F		-12	0x1F	+8		

Speaker Amplifier Signal Processing

The IC includes signal processing to improve the sound quality of the speaker output and protect transducers from damage. An excursion limiter dynamically adjusts the highpass corner frequency, while a power limiter and distortion limiter prevent the amplifier from outputting too much distortion or power. The excursion limiter is located in the DSP while the distortion limiter and power limiter control the analog volume control (Figure 28). All three limiters analyze the speaker amplifier's output signal to determine when to take action.

Excursion Limiter

The excursion limiter is a dynamic highpass filter that monitors the speaker outputs and increases the highpass corner frequency when the speaker amplifier's output exceeds a predefined threshold. The filter smoothly

transitions between the high and low corner frequency to prevent unwanted artifacts. The filter can operate in four different modes:

- **Fixed-Frequency Preset Mode.** The highpass corner frequency is fixed at the upper corner frequency and does not change with signal level.
- **Fixed-Frequency Programmable Mode.** The highpass corner frequency is fixed to that specified by the programmable biquad filter.
- **Preset Dynamic Mode.** The highpass filter automatically slides between a preset upper and lower corner frequency based on output signal level.
- **User-Programmable Dynamic Mode.** The highpass filter slides between a user-programmed biquad filter on the low side to a predefined corner frequency on the high side.

MAX98088

Stereo Audio Codec with FlexSound Technology

The transfer function for the user-programmable biquad is:

$$H(z) = \frac{b_0 + b_1z^{-1} + b_2z^{-2}}{1 + a_1z^{-1} + a_2z^{-2}}$$

The coefficients b_0 , b_1 , b_2 , a_1 , and a_2 are sample rate dependent and stored in registers 0xB4 through 0xC7. Store b_0 , b_1 , and b_2 as positive numbers. Store a_1 and a_2 as negated two's complement numbers. Separate filters can be stored for the DAI1 and DAI2 playback paths.

The MAX98088 EV kit software includes a graphic interface for generating the user-programmable biquad coefficients.

Note: Only change the excursion limiter settings when the signal path is disabled to prevent undesired artifacts.

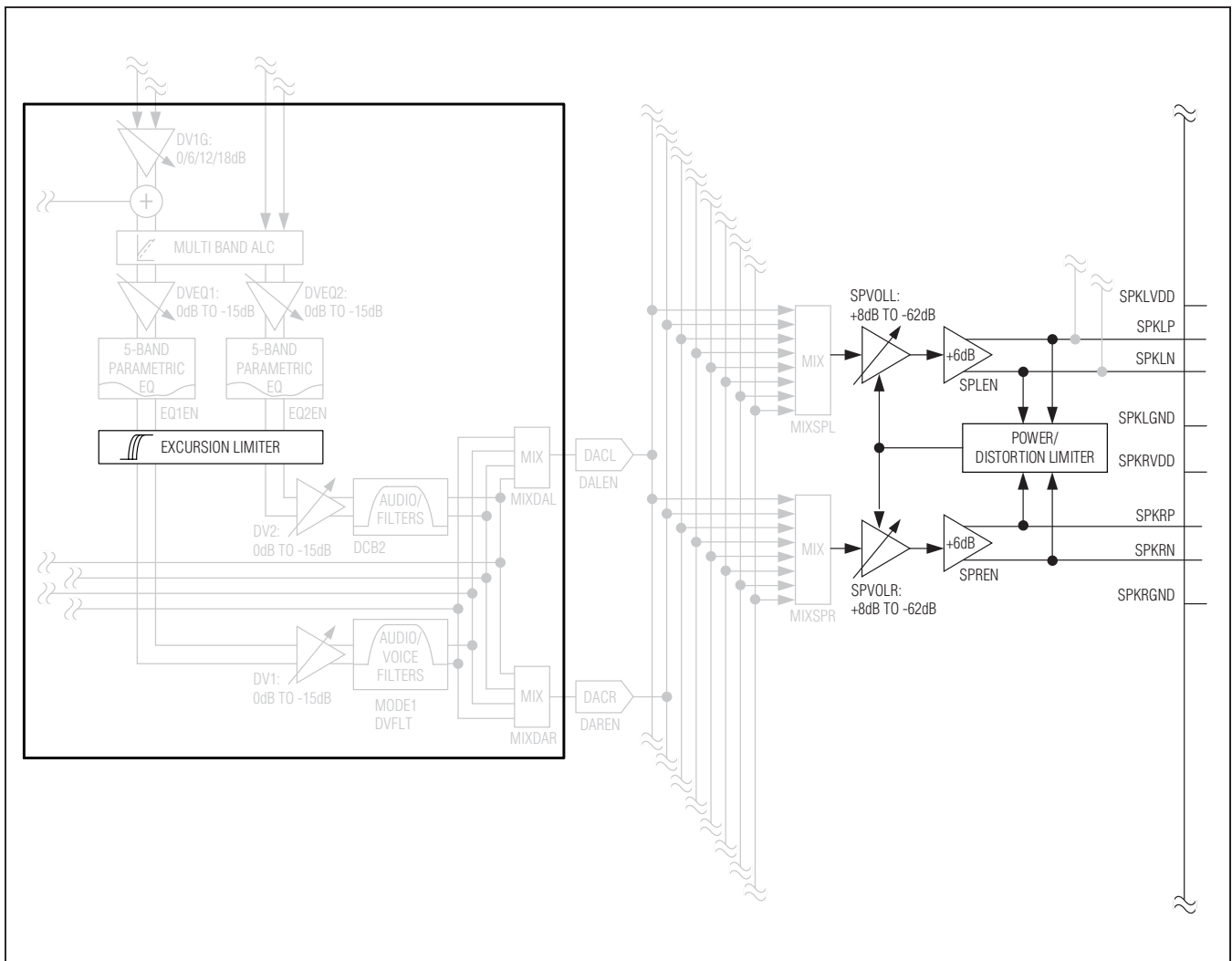

Figure 27. Speaker Amplifier Signal Processing Block Diagram

Stereo Audio Codec with FlexSound Technology

Table 24. Excursion Limiter Registers

REGISTER	BIT	NAME	DESCRIPTION					
0x41	6	DHPUCF	Excursion Limiter Corner Frequency The excursion limiter has limited sliding range and minimum corner frequencies. Listed below are all the valid filter combinations.					
	5		LOWER CORNER FREQUENCY	UPPER CORNER FREQUENCY	MINIMUM BIQUAD CORNER FREQUENCY	DHPUCF	DHPLCF	
			Excursion limiter disabled		—	000	00	
			400Hz		—	001	00	
			600Hz		—	010	00	
			800Hz		—	011	00	
	1kHz		—	100	00			
	4	1	DHPLCF	Programmable using biquad	100Hz	000	11	
				200Hz	400Hz	—	001	01
				400Hz	600Hz	—	010	10
				400Hz	800Hz	—	011	10
	0	0	DHPLCF	Programmable using biquad	400Hz	200Hz	001	11
				Programmable using biquad	600Hz	300Hz	010	11
				Programmable using biquad	800Hz	400Hz	011	11
Programmable using biquad				1kHz	500Hz	100	11	
0x43	6	ALCRLS	ALC and Excursion Limiter Release Time Sets the release time for both the ALC and Excursion Limiter. See the <i>Automatic Level Control</i> section for ALC release times. Excursion limiter release time is defined as the time required to slide from the high corner frequency to the low corner frequency.					
	5		VALUE	EXCURSION LIMITER RELEASE TIME (s)				
			000	4				
			001	2				
			010	1				
			011	0.5				
			100	0.25				
			101	0.25				
			110	Reserved				
111	Reserved							
0x42	3	DHPTH	Excursion Limiter Threshold Measured at the Class D speaker amplifier outputs. Signals above the threshold use the upper corner frequency. Signals below the threshold use the lower corner frequency. V_{BAT} must correctly reflect the voltage of SPKLVDD to achieve accurate thresholds.					
	2		000 = 0.34VP 001 = 0.71VP					
	1		010 = 1.30VP 011 = 1.77VP					
	0		100 = 2.33VP 101 = 3.25VP					
			110 = 4.25VP 111 = 4.95VP					

Stereo Audio Codec with FlexSound Technology

Power Limiter

The IC's power limiter tracks the continuous power delivered to the loudspeaker and briefly mutes the speaker amplifier output if the speaker is at risk of sustaining permanent damage.

Loudspeakers are typically damaged when the voice coil overheats due to extended operation above the rated power. During normal operation, heat generated in the voice coil is transferred to the speaker's magnet, which transfers heat to the surrounding air. For the voice coil to overheat, both the voice coil and the magnet must overheat. The result is that a loudspeaker can operate above its rated power for a significant time before it heats sufficiently to cause damage.

The IC's power limiter includes user-programmable time constants and power thresholds to match a wide range of loudspeakers. Program the power limiter's threshold to match the loudspeaker's rated power handling. This can be determined through measurement or the loudspeaker's specification. Program time constant 1 to match the voice coil's thermal time constant. Program time constant 2 to match the magnet's thermal time constant. The time constants can be determined by plotting the voice coil's resistance vs. time as power is applied to the speaker.

Table 25. Power Limiter Registers

REGISTER	BIT	NAME	DESCRIPTION			
0x44	7	PWRTH	Power Limiter Threshold If the continuous output power from the speaker amplifiers exceeds this threshold, the output is briefly muted to protect the speaker. The threshold is measured in watts assuming an 8Ω load. VBAT must correctly reflect the voltage of SPKLVDV/SPKRVDD to achieve accurate thresholds.			
	6		VALUE	THRESHOLD (W)	VALUE	THRESHOLD (W)
			0x0	Power limiter disabled	0x8	0.27
	5		0x1	0.05	0x9	0.35
			0x2	0.06	0xA	0.48
			0x3	0.09	0xB	0.72
			0x4	0.11	0xC	1.00
			0x5	0.13	0xD	1.43
	4		0x6	0.18	0xE	1.57
		0x7	0.22	0xF	1.80	
	2	PWRK	Power Limiter Weighting Factor Determines the balance between time constant 1 and 2 to match the dominance of each time constant in the loudspeaker.			
	1		VALUE	T1 (%)	T2 (%)	
			000	50	50	
			001	62.5	37.5	
			010	75	25	
011			87.5	12.5		
100			100	0		
101			12.5	87.5		
0	110	25	75			
	111	37.5	62.5			

Stereo Audio Codec with FlexSound Technology

Table 25. Power Limiter Registers (continued)

REGISTER	BIT	NAME	DESCRIPTION			
0x45	7	PWRT2	Power Limiter Time Constant 2 Select a value that matches the thermal time constant of the loudspeaker's magnet.			
	6		VALUE	TIME CONSTANT (min)	VALUE	TIME CONSTANT (min)
			0x0	Disabled	0x8	3.75
	5		0x1	0.50	0x9	5.00
			0x2	0.67	0xA	6.66
			0x3	0.89	0xB	8.88
			0x4	1.19	0xC	Reserved
	4		0x5	1.58	0xD	Reserved
		0x6	2.11	0xE	Reserved	
	3	PWRT1	Power Limiter Time Constant 1 Select a value that matches the thermal time constant of the loudspeaker's voice coil.			
			VALUE	TIME CONSTANT (s)	VALUE	TIME CONSTANT (s)
			0x0	Disabled	0x8	3.75
			0x1	0.50	0x9	5.00
			0x2	0.67	0xA	6.66
			0x3	0.89	0xB	8.88
			0x4	1.19	0xC	Reserved
0x5			1.58	0xD	Reserved	
2	0x6	2.11	0xE	Reserved		
	0x7	2.81	0xF	Reserved		
1	0	PWRT1	Power Limiter Time Constant 1 Select a value that matches the thermal time constant of the loudspeaker's voice coil.			
0			VALUE	TIME CONSTANT (s)	VALUE	TIME CONSTANT (s)
0	0x0	Disabled	0x8	3.75		
0	0x1	0.50	0x9	5.00		
0	0x2	0.67	0xA	6.66		
0	0x3	0.89	0xB	8.88		
0	0x4	1.19	0xC	Reserved		
0	0x5	1.58	0xD	Reserved		
0	0x6	2.11	0xE	Reserved		
0	0x7	2.81	0xF	Reserved		

Distortion Limiter

The IC's distortion limiter ensures that the speaker amplifier's output does not exceed the programmed THD+N limit. The distortion limiter analyzes the Class D output duty cycle to determine the percentage of the waveform that is clipped. If the distortion exceeds the programmed threshold, the output gain is reduced.

Stereo Audio Codec with FlexSound Technology

Table 26. Distortion Limiter Registers

REGISTER	BIT	NAME	DESCRIPTION			
0x46	7	THDCLP	Distortion Limit Measured in % THD+N.			
	6		VALUE	THD+N LIMIT (%)	VALUE	THD+N LIMIT (%)
			0x0	Limiter disabled	0x8	12
	5		0x1	< 1	0x9	14
			0x2	1	0xA	16
			0x3	2	0xB	18
			0x4	4	0xC	20
			0x5	6	0xD	21
			0x6	8	0xE	22
	4		0x7	10	0xF	24
		0	THDT1	Distortion Limiter Release Time Constant Duration of time required for the speaker amplifier's output gain to adjust back to the nominal level after a large signal has passed. 0 = 1.4s 1 = 2.8s		

Headphone

DirectDrive Headphone Amplifier

Traditional single-supply headphone amplifiers have outputs biased at a nominal DC voltage (typically half the supply). Large coupling capacitors are needed to block this DC bias from the headphone. Without these capacitors, a significant amount of DC current flows to the headphone, resulting in unnecessary power dissipation and possible damage to both headphone and headphone amplifier.

Maxim's second-generation DirectDrive architecture uses a charge pump to create an internal negative supply voltage. This allows the headphone outputs of the ICs to be biased at GND while operating from a single supply (Figure 28). Without a DC component, there is no need for the large DC-blocking capacitors. Instead of two large (220µF typ) capacitors, the IC's charge pump requires 3 small ceramic capacitors, conserving board space, reducing cost, and improving the frequency response of the headphone amplifier.

Charge Pump

The dual-mode charge pump generates both the positive and negative power supply for the headphone amplifier. To maximize efficiency, both the charge pump's switching frequency and output voltage change based on signal level.

When the input signal level is less than 10% of PVDD, the switching frequency is reduced to a low rate. This minimizes switching losses in the charge pump. When the input signal exceeds 10% of PVDD, the switching frequency increases to support the load current.

For input signals below 25% of PVDD, the charge pump generates $\pm(PVDD/2)$ to minimize the voltage drop across the amplifier's power stage and thus improve efficiency. Input signals that exceed 25% of PVDD cause the charge pump to output $\pm PVDD$. The higher output voltage allows for full output power from the headphone amplifier.

To prevent audible glitches when transitioning from the $\pm(PVDD/2)$ output mode to the $\pm PVDD$ output mode, the charge pump transitions very quickly. This quick change draws significant current from PVDD for the duration of the transition. The bypass capacitor on PVDD supplies the required current and prevents droop on PVDD.

The charge pump's dynamic switching mode can be turned off through the I²C interface. The charge pump can then be forced to output either $\pm(PVDD/2)$ or $\pm PVDD$ regardless of input signal level.

MAX98088

Stereo Audio Codec with FlexSound Technology

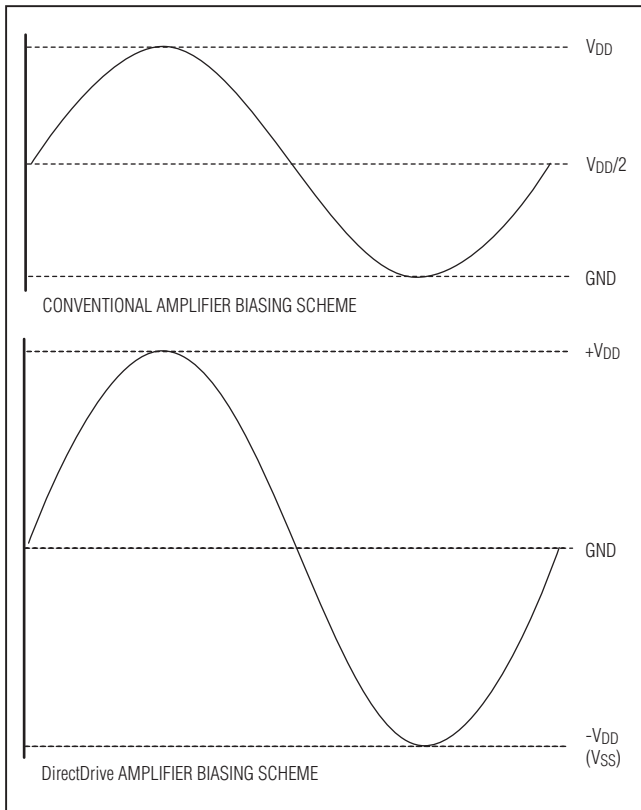

Figure 28. Traditional Amplifier Output vs. DirectDrive Output

Class H Operation

A Class H amplifier uses a Class AB output stage with power supplies that are modulated by the output signal. In the case of the ICs, two nominal power-supply differentials of 1.8V (+0.9V to -0.9V) and 3.6V (+1.8V to -1.8V) are available from the charge pump. [Figure 29](#) shows the operation of the output-voltage-dependent power supply

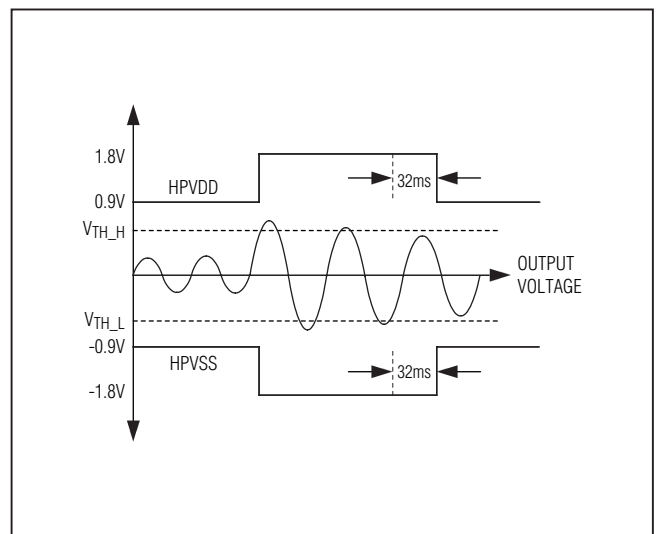

Figure 29. Class H Operation

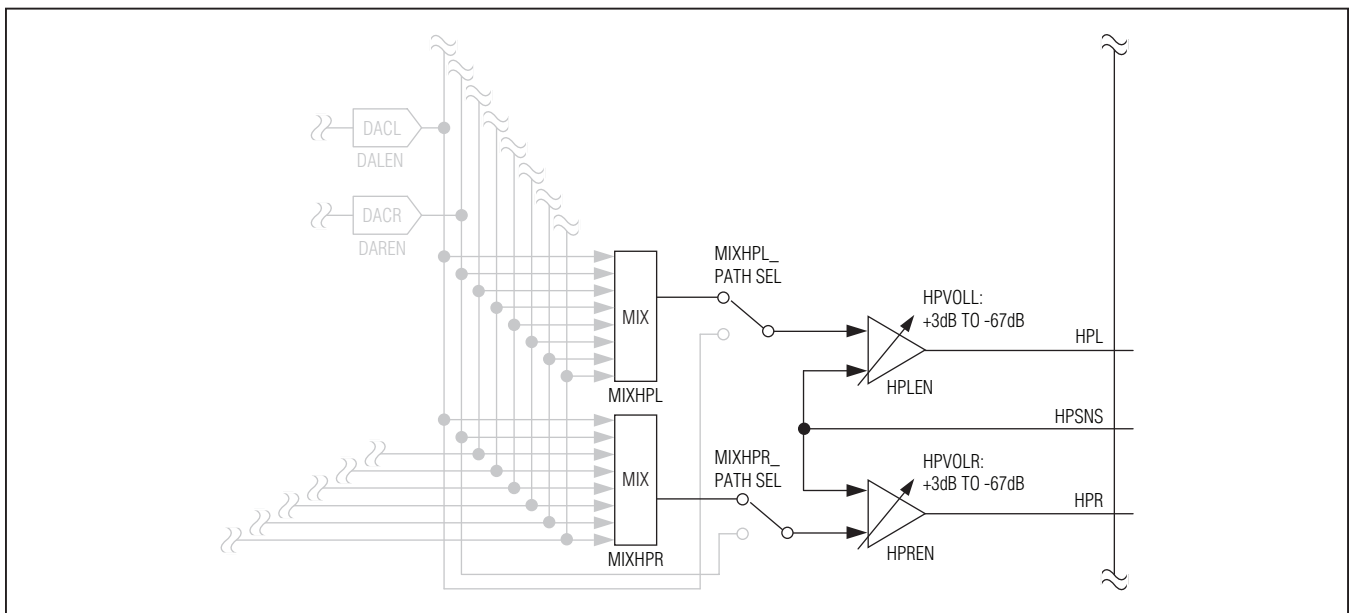

Figure 30. Headphone Amplifier Block Diagram

Stereo Audio Codec with FlexSound Technology

Headphone Output Mixers

The headphone amplifier mixer accepts input from the stereo DAC, the line inputs (single-ended or differential), and the MIC inputs. Configure the mixer to mix any combination of the available sources. When more than one

signal is selected, the mixer can be configured to attenuate the signal by 6dB, 9dB, or 12dB. The stereo DAC can bypass the headphone mixers, and be connected directly to the headphone amplifiers to provide lower power consumption.

Table 27. Headphone Output Mixer Register

REGISTER	BIT	NAME	DESCRIPTION
0x25	7	MIXHPL	Left Headphone Output Mixer 1xxxxxxx = Right DAC x1xxxxxx = MIC2 xx1xxxxx = MIC1 xxx1xxxx = INB2 (INBDIFF = 0) or INB2-INB1 (INBDIFF = 1) xxxx1xxx = INB1 xxxxx1xx = INA2 (INADIFF = 0) or INA2-INB1 (INADIFF = 1) xxxxxx1x = INA1 xxxxxxx1 = Left DAC
	6		
	5		
	4		
	3		
	2		
	1		
	0		
0x26	7	MIXHPR	Right Headphone Output Mixer 1xxxxxxx = Left DAC x1xxxxxx = MIC2 xx1xxxxx = MIC1 xxx1xxxx = INB2 (INBDIFF = 0) or INB2-INB1 (INBDIFF = 1) xxxx1xxx = INB1 xxxxx1xx = INA2 (INADIFF = 0) or INA2-INA1 (INADIFF = 1) xxxxxx1x = INA1 xxxxxxx1 = Right DAC
	6		
	5		
	4		
	3		
	2		
	1		
	0		
0x27	5	MIXHPR_PATH_SEL	Right Headphone Mixer Path Select 0 = Directly connect to the right DAC (bypass right headphone output mixer) 1 = Right headphone output mixer
	4	MIXHPL_PATH_SEL	Left Headphone Mixer Path Select 0 = Directly connect to the left DAC (bypass left headphone output mixer) 1 = Left headphone output mixer
	3	MIXHPR_GAIN	Right Headphone Mixer Gain Select 00 = 0dB 01 = -6dB 10 = -9dB 11 = -12dB
	1	MIXHPL_GAIN	Left Headphone Mixer Gain Select 00 = 0dB 01 = -6dB 10 = -9dB 11 = -12dB

Stereo Audio Codec with FlexSound Technology

Headphone Output Volume

Table 28. Headphone Output Level Register

REGISTER	BIT	NAME	DESCRIPTION			
0x39/0x3A	7	HPLM/HPRM	Headphone Output Mute 0 = Disabled 1 = Enabled			
	4	HPVOLL/HPVOLR	Left/Right Headphone Output Volume Level			
			VALUE	VOLUME (dB)	VALUE	VOLUME (dB)
			0x00	-67	0x10	-15
			0x01	-63	0x11	-13
			0x02	-59	0x12	-11
			0x03	-55	0x13	-9
			0x04	-51	0x14	-7
			0x05	-47	0x15	-5
			0x06	-43	0x16	-4
			0x07	-40	0x17	-3
			0x08	-37	0x18	-2
			0x09	-34	0x19	-1
			0x0A	-31	0x1A	0
			0x0B	-28	0x1B	+1
			0x0C	-25	0x1C	+1.5
			0x0D	-22	0x1D	+2
0x0E	-19	0x1E	+2.5			
0x0F	-17	0x1F	+3			

Stereo Audio Codec with FlexSound Technology

Output Bypass Switches

The IC includes two output bypass switches that solve common applications problems. When a single transducer is used for the loudspeaker and receiver, the need exists for two amplifiers to power the same transducer. Bypass switches connect the IC's receiver amplifier output to the speaker amplifier's output, allowing either amplifier to power the same transducer. In systems where

an external receiver amplifier is used, route its output to the left speaker through RECP/RXINP and REC/N/RXINN, bypassing the Class D amplifier. In systems where an external amplifier drives both the receiver and the IC's line input, one of the differential signals can be disconnected from the receiver when not needed by passing it through the analog switch that connects RECP/RXINP to REC/N/RXINN.

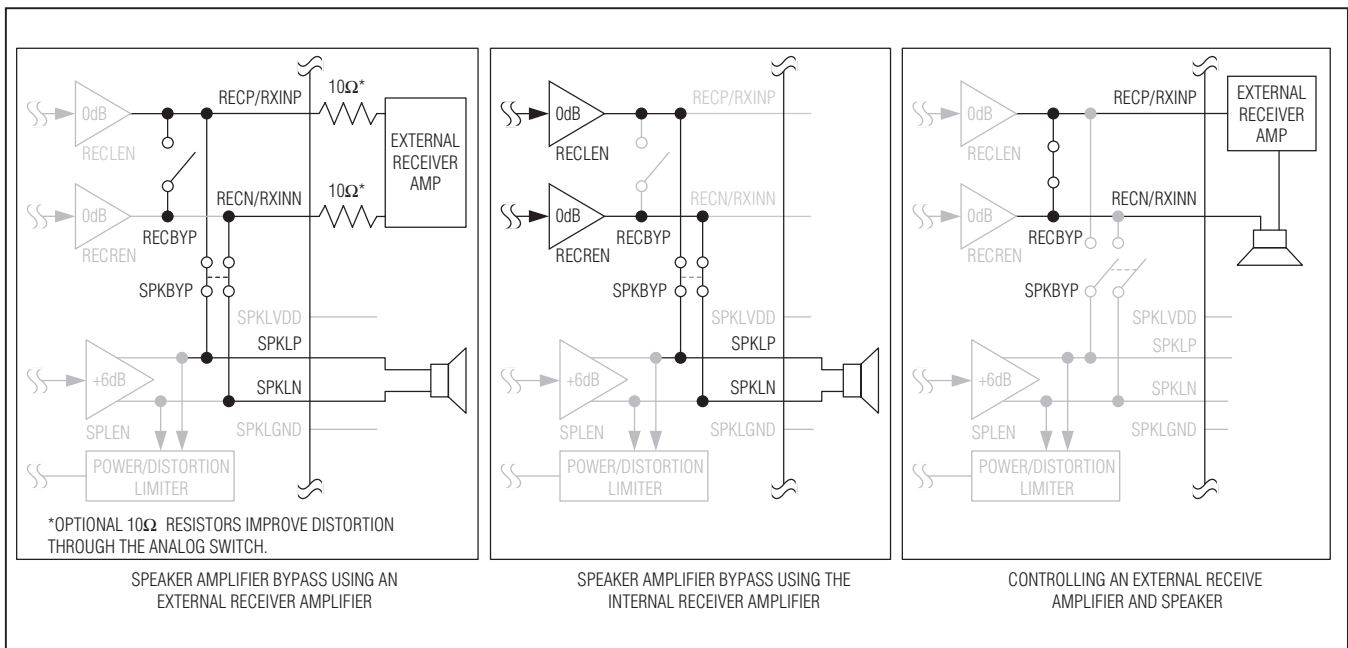

Figure 31. Output Bypass Switch Block Diagrams

Table 29. Output Bypass Switches Register

REGISTER	BIT	NAME	DESCRIPTION
0x4A	7	INABYP	See the <i>Microphone Inputs</i> section.
	4	MIC2BYP	
	1	RECBYP	RXINP to RXINN Bypass Switch Shorts RXINP to RXINN allowing a signal to pass through the ICs. Disable the receiver amplifier when RECBYP = 1. 0 = Disabled 1 = Enabled
	0	SPKBYP	RXIN to SPKL Bypass Switch Shorts RXINP/RXINN to SPKLP/SPKLN allowing either the internal or an external receiver amplifier to power the left speaker. Disable the left speaker amplifier when SPKBYP = 1. 0 = Disabled 1 = Enabled

Stereo Audio Codec with FlexSound Technology

Click-and-Pop Reduction

The IC includes extensive click-and-pop reduction circuitry. The circuitry minimizes clicks and pops at turn-on, turn-off, and during volume changes.

Zero-crossing detection is implemented on all analog PGAs and volume controls to prevent large glitches when volume changes are made. Instead of making a volume change immediately, the change is made when the audio signal crosses the midpoint. If no zero-crossing occurs within the timeout window, the change is forced.

Volume slewing breaks up large volume changes into the smallest available step size and the steps through each step between the initial and final volume setting. When

enabled, volume slewing also occurs at device turn-on and turn-off. During turn-on the volume is set to mute before the output is enabled. Once the output is on, the volume ramps to the desired level. At turn-off the volume is ramped to mute before the outputs are disabled.

When there is no audio signal zero-crossing detection can prevent volume slewing from occurring. Enable enhanced volume slewing to prevent the volume controller from requesting another volume level until the previous one has been set. Each step in the volume ramp then occurs after a zero crossing has occurred in the audio signal or the timeout window has expired. During turn-off, enhance volume slewing is always disabled.

Table 30. Click-and-Pop Reduction Register

REGISTER	BIT	NAME	DESCRIPTION
0x47	7	$\overline{\text{VS2EN}}$	<p>Enhanced Volume Smoothing During volume slewing, the controller waits for each step in the ramp to be applied before sending the next step. When zero-crossing detection is enabled this prevents large steps in the output volume when no zero crossings are detected. 0 = Enabled 1 = Disabled Applies to volume changes in HPVOLL, HPVOLR, RECVOL, SPVOLL, and SPVOLR.</p>
	6	$\overline{\text{VSEN}}$	<p>Volume Adjustment Smoothing Volume changes are smoothed by stepping through intermediate steps. Also ramps the volume from minimum to the programmed value at turn-on and back to minimum at turn-off. 0 = Enabled 1 = Disabled Applies to volume changes in HPVOLL, HPVOLR, RECVOL, SPVOLL, and SPVOLR.</p>
	5	$\overline{\text{ZDEN}}$	<p>Zero-Crossing Detection Holds volume changes until there is a zero crossing in the audio signal. This reduces click and pop during volume changes (zipper noise). If no zero crossing is detected within 100ms, the volume change is forced. 0 = Enabled 1 = Disabled Applies to volume changes in PGAM1, PGAM2, PGAOUTA, PGAOUTB, PGAOUTC, HPVOLL, HPVOLR, RECVOL, SPVOLL, and SPVOLR.</p>
	1	EQ2EN	See the <i>5-Band Parametric EQ</i> section.
0	EQ1EN		

Stereo Audio Codec with FlexSound Technology

Jack Detection

The IC features jack detection that can detect the insertion and removal of a jack. When a jack is detected, an interrupt on \overline{IRQ} can be triggered to alert the microcontroller of the event. [Figure 32](#) shows the typical configuration for jack detection.

Jack Detection and Removal

When the IC is in normal operation and the MICBIAS is enabled, jack insertion and removal can be detected

through JACKSNS. To detect a jack insertion and removal, the ICs must be powered on and MICBIAS enabled. Set JDETEN, MBEN, BIASEN, and VCMEN bits to enable jack detection circuitry. JACKSNS is pulled up by MICBIAS as long as no load is applied to JACKSNS. [Table 31](#) shows the change in JACKSNS that occurs when a jack is inserted and removed.

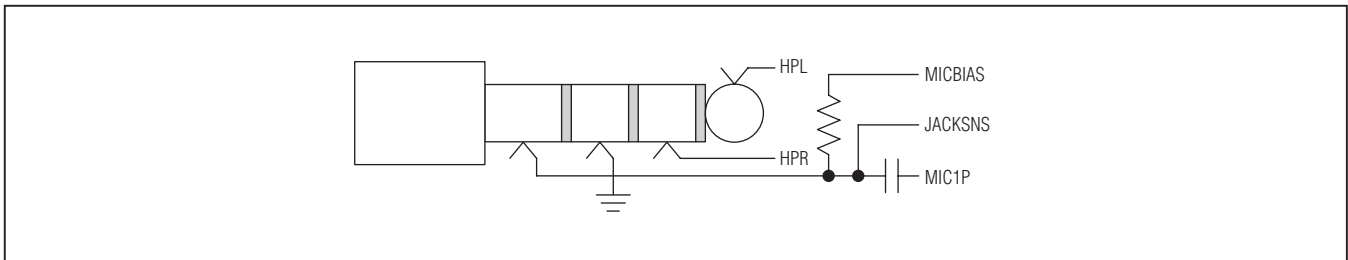

Figure 32. Typical Configuration for Jack Detection

Table 31. Change in JACKSNS Upon Jack Insertion

JACK TYPE	MBEN = 1, BIASEN = 1, VCMEN = 1
	JACKSNS: 1 → 0
	JACKSNS: 1 → 0

Table 32. Change in JACKSNS Upon Jack Removal

JACK TYPE	MBEN = 1, BIASEN = 1, VCMEN = 1
	JACKSNS: 0 → 1
	JACKSNS: 0 → 1

Stereo Audio Codec with FlexSound Technology

Table 33. Jack Detection Registers

REGISTER	BIT	NAME	DESCRIPTION
0x02 (Read Only)	6	JKSNS	JACKSNS State Reports the status of JACKSNS when JDETEN = 1, MBEN = 1, BIASEN = 1, and VCMEN = 1. 0 = JACKSNS low 1 = JACKSNS high
0x4B	7	JDETEN	Jack Detection Enable 0 = Disabled 1 = Enabled
	1	JDEB	Jack Detection Debounce Configures the debounce time for setting JDET. 00 = 25ms 01 = 50ms 10 = 100ms 11 = 200ms
	0		

Battery Measurement

The IC measures the voltage applied to SPKLVDD (typically the battery voltage) and reports the value in register 0x03. This value is also used by the speaker limiter circuitry to set accurate thresholds. When the battery measurement function is disabled, the battery voltage is user programmable.

Table 34. Battery Measurement Registers

REGISTER	BIT	NAME	DESCRIPTION
0x03	4	VBAT	Battery Voltage Read VBAT when VBATEN = 1 to determine VSPKLVDD. Program VBAT when VBATEN = 0 to allow proper speaker amplifier signal processing. Calculate/program the battery voltage using the following formula: $V_{BATTERY} = 2.55V + [VBAT/10]$
	3		
	2		
	1		
	0		
0x51	7	SHDN	See the <i>Power Management</i> section.
	6	VBATEN	Battery Measurement Enable. Enables an internal ADC to measure VSPKLVDD. 0 = Disabled (register 0x03 readable and writeable) 1 = Enabled (register 0x03 read only)
	3	PERFMODE	See the <i>Power Management</i> section.
	2	HPPLYBCK	See the <i>Power Management</i> section.
	1	PWRSV8K	See the <i>Power Management</i> section.
	0	PWRSV	See the <i>Power Management</i> section.

Stereo Audio Codec with FlexSound Technology

Device Status

The IC uses register 0x00 and $\overline{\text{IRQ}}$ to report the status of various device functions. The status register bits are set when their respective events occur, and cleared upon reading the register. Device status can be determined

either by polling register 0x00 or configuring the $\overline{\text{IRQ}}$ to pull low when specific events occur. $\overline{\text{IRQ}}$ is an open-drain output that requires a pullup resistor for proper operation. Register 0x0F determines which bits in the status register trigger $\overline{\text{IRQ}}$ to pull low.

Table 35. Status and Interrupt Registers

REGISTER	BIT	NAME	DESCRIPTION
0x00 (Read Only)	7	CLD	Full Scale 0 = All digital signals are less than full scale. 1 = The DAC or ADC signal path has reached or exceeded full scale. This typically indicates clipping.
	6	SLD	Volume Slew Complete SLD reports that any of the programmable-gain arrays or volume controllers has completed slewing from a previous setting to a new programmed setting. If multiple gain arrays or volume controllers are changed at the same time, the SLD flag is set after the last volume slew completes. SLD also reports when the digital audio interface soft-start or soft-stop process has completed. MCLK is required for proper SLD operation. 0 = No volume slewing sequences have completed since the status register was last read. 1 = Volume slewing complete.
	5	ULK	Digital Audio Interface Unlocked 0 = Both digital audio interfaces are operating normally. 1 = Either digital audio interface is configured incorrectly or receiving invalid clocks.
	1	JDET	Jack Configuration Change JDET reports changes to any bit in the Jack Status register (0x02). Changes to the Jack Status bits are debounced before setting JDET. The debounce period is programmable using the JDEB bits. JDET is always set the first time JDETEN or $\overline{\text{SHDN}}$ is set the first time power is applied to the IC. Read the status register following such an event to clear JDET and allow for proper jack detection. 0 = No change in jack configuration. 1 = Jack configuration has changed.
0x0F	7	ICLD	Full-Scale Interrupt Enable 0 = Disabled 1 = Enabled
	6	ISLD	Volume Slew Complete Interrupt Enable 0 = Disabled 1 = Enabled
	5	IULK	Digital Audio Interface Unlocked Interrupt Enable 0 = Disabled 1 = Enabled
	1	IJDET	Jack Configuration Change Interrupt Enable 0 = Disabled 1 = Enabled

Stereo Audio Codec with FlexSound Technology

Device Revision

Table 36. Device Revision Register

REGISTER	BIT	NAME	DESCRIPTION
0xFF (Read Only)	7	REV	Device Revision Code REV is always set to 0x40.
	6		
	5		
	4		
	3		
	2		
	1		
0			

I²C Serial Interface

The IC features an I²C/SMBus™-compatible, 2-wire serial interface comprising a serial-data line (SDA) and a serial-clock line (SCL). SDA and SCL facilitate communication between the IC and the master at clock rates up to 400kHz. Figure 5 shows the 2-wire interface timing diagram. The master generates SCL and initiates data transfer on the bus. The master device writes data to the IC by transmitting the proper slave address followed by the register address and then the data word. Each transmit sequence is framed by a START (S) or REPEATED START (Sr) condition and a STOP (P) condition. Each word transmitted to the IC is 8 bits long and is followed by an acknowledge clock pulse. A master reading data from the IC transmits the proper slave address followed by a series of nine SCL pulses. The IC transmits data on SDA in sync with the master-generated SCL pulses. The master acknowledges receipt of each byte of data. Each read sequence is framed by a START or REPEATED START condition, a not acknowledge, and a STOP condition. SDA operates as both an input and an open-drain output. A pullup resistor, typically greater than 500Ω, is required on SDA. SCL operates only as an input. A pullup resistor, typically greater than 500Ω, is required on SCL if there are multiple masters on the bus, or if the single master has an open-drain SCL output. Series resistors in line with SDA and SCL are optional. Series resistors

protect the digital inputs of the IC from high voltage spikes on the bus lines, and minimize crosstalk and undershoot of the bus signals.

Bit Transfer

One data bit is transferred during each SCL cycle. The data on SDA must remain stable during the high period of the SCL pulse. Changes in SDA while SCL is high are control signals (see the [START and STOP Conditions](#) section).

START and STOP Conditions

SDA and SCL idle high when the bus is not in use. A master initiates communication by issuing a START condition. A START condition is a high-to-low transition on SDA with SCL high. A STOP condition is a low-to-high transition on SDA while SCL is high (Figure 33). A START condition from the master signals the beginning of a transmission to the IC. The master terminates transmission, and frees the bus, by issuing a STOP condition. The bus remains active if a REPEATED START condition is generated instead of a STOP condition.

Early STOP Conditions

The IC recognizes a STOP condition at any point during data transmission except if the STOP condition occurs in the same high pulse as a START condition. For proper operation, do not send a STOP condition during the same SCL high pulse as the START condition.

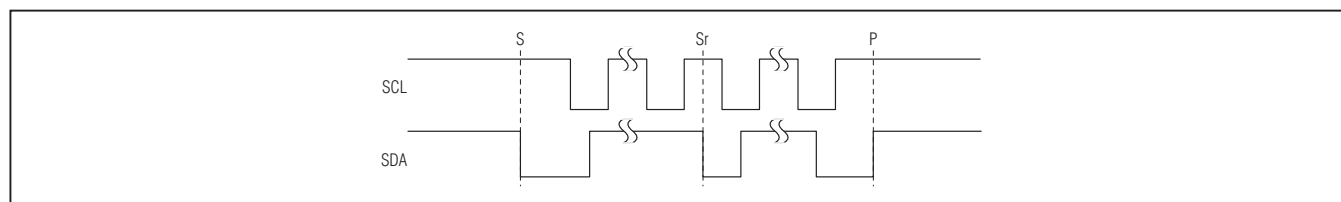

Figure 33. START, STOP, and REPEATED START Conditions

SMBus is a trademark of Intel Corp.

Stereo Audio Codec with FlexSound Technology

Slave Address

The slave address is defined as the seven most significant bits (MSBs) followed by the read/write bit. For the IC, the seven most significant bits are 0010000. Setting the read/write bit to 1 (slave address = 0x21) configures the IC for read mode. Setting the read/write bit to 0 (slave address = 0x20) configures the ICs for write mode. The address is the first byte of information sent to the IC after the START condition.

Acknowledge

The acknowledge bit (ACK) is a clocked 9th bit that the IC uses to handshake receipt each byte of data when in write mode (Figure 34). The IC pulls down SDA during the entire master-generated 9th clock pulse if the previous byte is successfully received. Monitoring ACK allows for detection of unsuccessful data transfers. An unsuccessful data transfer occurs if a receiving device

is busy or if a system fault has occurred. In the event of an unsuccessful data transfer, the bus master retries communication. The master pulls down SDA during the 9th clock cycle to acknowledge receipt of data when the IC is in read mode. An acknowledge is sent by the master after each read byte to allow data transfer to continue. A not acknowledge is sent when the master reads the final byte of data from the IC, followed by a STOP condition.

Write Data Format

A write to the IC includes transmission of a START condition, the slave address with the R/W bit set to 0, one byte of data to configure the internal register address pointer, one or more bytes of data, and a STOP condition. Figure 35 illustrates the proper frame format for writing one byte of data to the IC. Figure 36 illustrates the frame format for writing n-bytes of data to the IC.

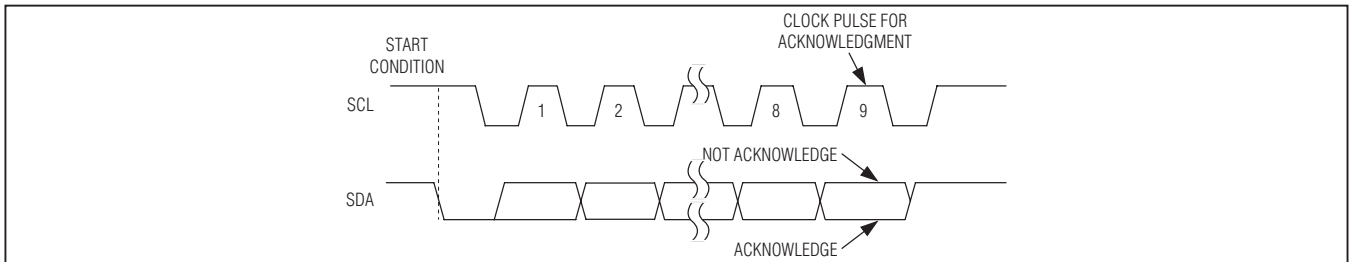

Figure 34. Acknowledge

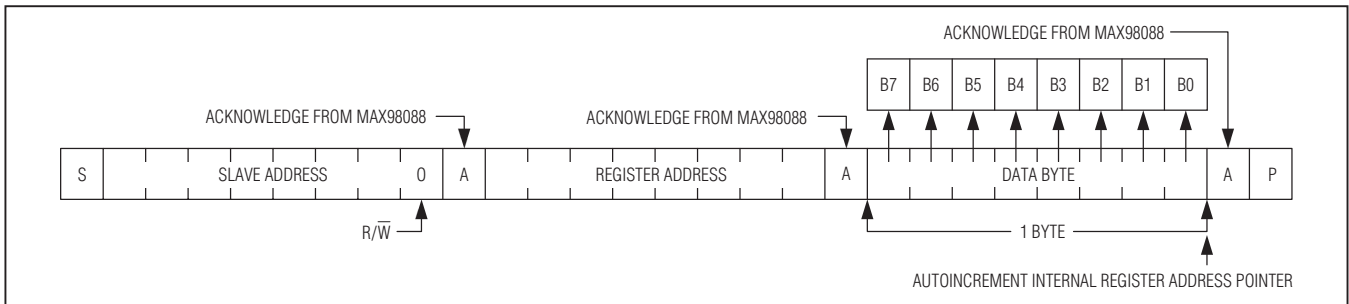

Figure 35. Writing One Byte of Data to the ICs

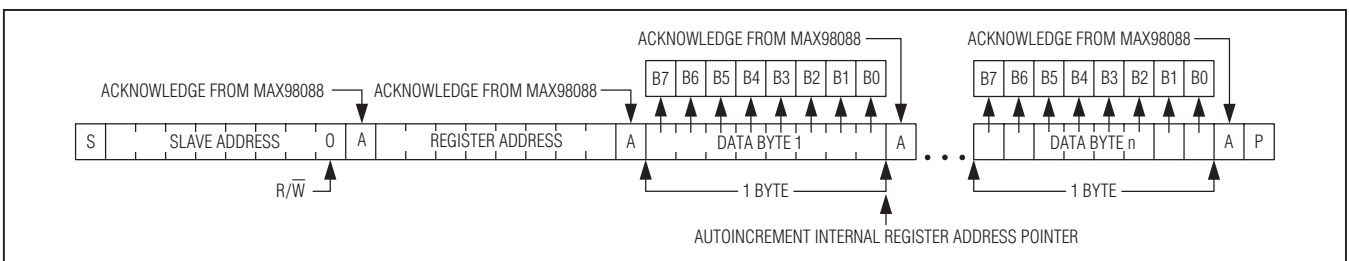

Figure 36. Writing n-Bytes of Data to the ICs

Stereo Audio Codec with FlexSound Technology

The slave address with the R/\bar{W} bit set to 0 indicates that the master intends to write data to the ICs. The ICs acknowledge receipt of the address byte during the master-generated 9th SCL pulse.

The second byte transmitted from the master configures the IC's internal register address pointer. The pointer tells the IC where to write the next byte of data. An acknowledge pulse is sent by the ICs upon receipt of the address pointer data.

The third byte sent to the ICs contains the data that is written to the chosen register. An acknowledge pulse from the ICs signals receipt of the data byte. The address pointer autoincrements to the next register address after each received data byte. This autoincrement feature allows a master to write to sequential registers within one continuous frame. The master signals the end of transmission by issuing a STOP condition. Register addresses greater than 0xC7 are reserved. Do not write to these addresses.

Read Data Format

Send the slave address with the R/\bar{W} bit set to 1 to initiate a read operation. The IC acknowledges receipt of its slave address by pulling SDA low during the 9th SCL clock pulse. A START command followed by a read command resets the address pointer to register 0x00.

The first byte transmitted from the ICs is the content of register 0x00. Transmitted data is valid on the rising edge of SCL. The address pointer autoincrements after each read data byte. This autoincrement feature allows all registers to be read sequentially within one continuous frame. A STOP condition can be issued after any number of read data bytes. If a STOP condition is issued followed by another read operation, the first data byte to be read is from register 0x00.

The address pointer can be preset to a specific register before a read command is issued. The master presets the address pointer by first sending the IC's slave address with the R/\bar{W} bit set to 0 followed by the register address. A REPEATED START condition is then sent followed by the slave address with the R/\bar{W} bit set to 1. The IC then transmits the contents of the specified register. The address pointer autoincrements after transmitting the first byte.

The master acknowledges receipt of each read byte during the acknowledge clock pulse. The master must acknowledge all correctly received bytes except the last byte. The final byte must be followed by a not acknowledge from the master and then a STOP condition. [Figure 37](#) illustrates the frame format for reading one byte from the IC. [Figure 38](#) illustrates the frame format for reading multiple bytes from the ICs.

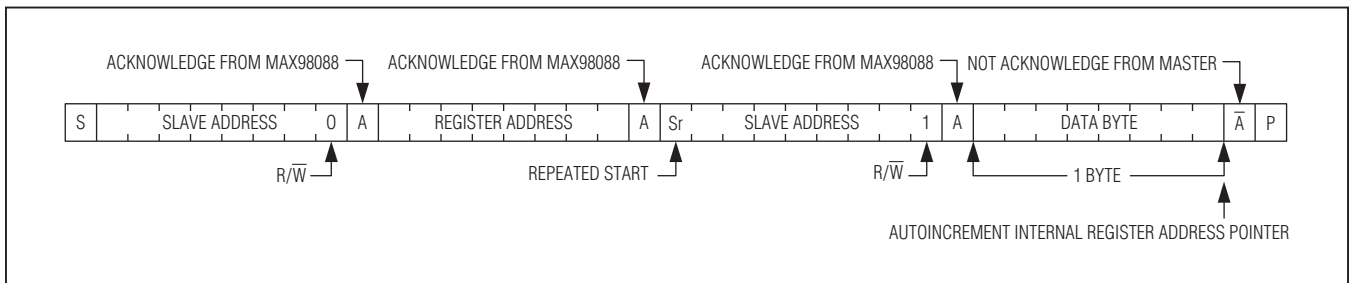

Figure 37. Reading One Byte of Data from the ICs

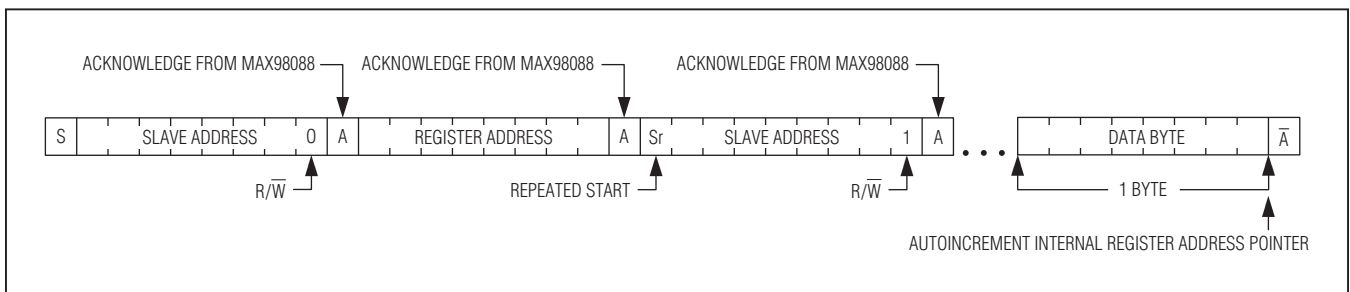

Figure 38. Reading n Bytes of Data from the ICs

MAX98088

Stereo Audio Codec with FlexSound Technology

Applications Information

Typical Operating Circuits

Figures 39 and 40 provide example operating circuits for the ICs. The external components shown are the minimum required for the ICs to operate. Additional components may be required by the application.

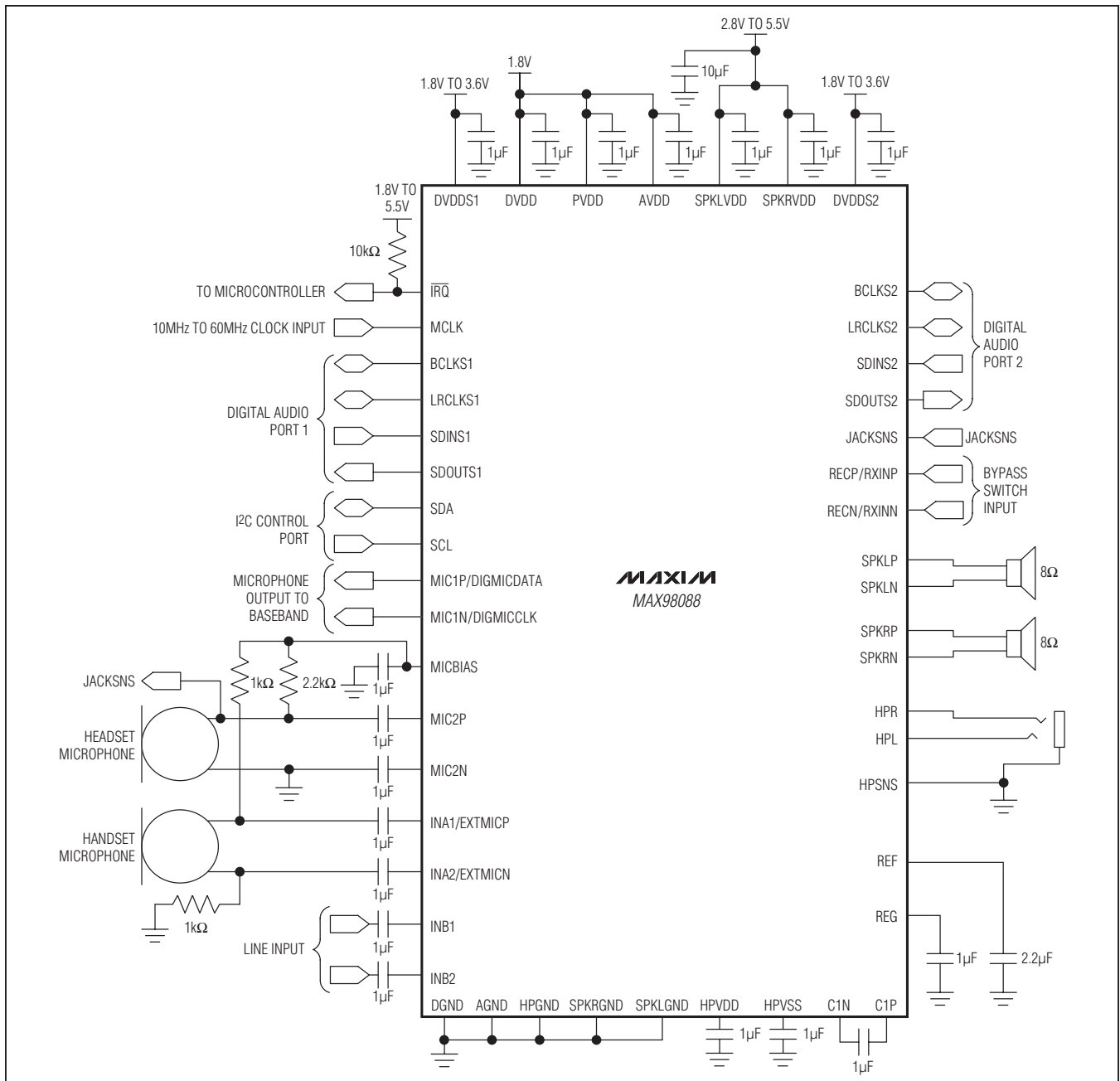

Figure 39. Typical Application Circuit Using Analog Microphone Inputs and the Bypass Switch

MAX98088

Stereo Audio Codec with FlexSound Technology

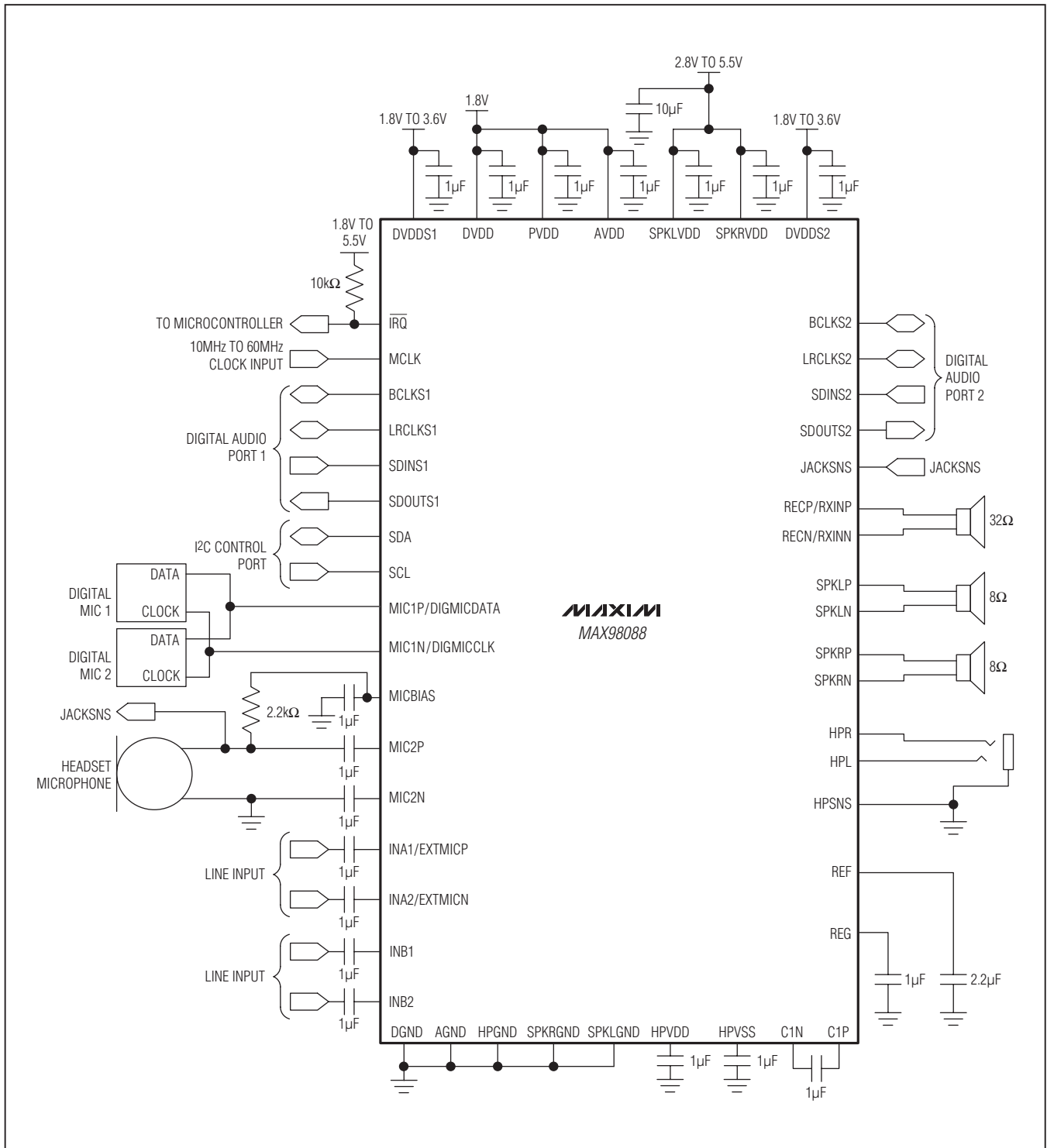

Figure 40. Typical Application Circuit Using the Digital Microphone Input and Receiver Amplifier

Stereo Audio Codec with FlexSound Technology

Filterless Class D Operation

Traditional Class D amplifiers require an output filter to recover the audio signal from the amplifier's output. The filters add cost, increase the solution size of the amplifier, and can decrease efficiency and THD+N performance. The traditional PWM scheme uses large differential output swings ($2 \times V_{DD}$ peak to peak) and causes large ripple currents. Any parasitic resistance in the filter components results in a loss of power, lowering the efficiency.

The IC does not require an output filter. The device relies on the inherent inductance of the speaker coil and the natural filtering of both the speaker and the human ear to recover the audio component of the square-wave output. Eliminating the output filter results in a smaller, less costly, more efficient solution.

Because the frequency of the IC's output is well beyond the bandwidth of most speakers, voice coil movement due to the square-wave frequency is very small. Although this movement is small, a speaker not designed to handle the additional power can be damaged. For optimum results, use a speaker with a series inductance $> 10\mu\text{H}$. Typical 8Ω speakers exhibit series inductances in the $20\mu\text{H}$ to $100\mu\text{H}$ range.

RF Susceptibility

GSM radios transmit using time-division multiple access (TDMA) with 217Hz intervals. The result is an RF signal with strong amplitude modulation at 217Hz and its harmonics that is easily demodulated by audio amplifiers. The IC is designed specifically to reject RF signals; however, PCB layout has a large impact on the susceptibility of the end product.

In RF applications, improvements to both layout and component selection decrease the IC's susceptibility to RF noise and prevent RF signals from being demodulated into audible noise. Trace lengths should be kept below $1/4$ of the wavelength of the RF frequency of interest. Minimizing the trace lengths prevents them from functioning as antennas and coupling RF signals into the IC. The wavelength (λ) in meters is given by: $\lambda = c/f$ where $c = 3 \times 10^8$ m/s, and f = the RF frequency of interest.

Route audio signals on middle layers of the PCB to allow ground planes above and below to shield them from RF interference. Ideally, the top and bottom layers of the PCB should primarily be ground planes to create effective shielding.

Additional RF immunity can also be obtained by relying on the self-resonant frequency of capacitors as it exhibits a frequency response similar to a notch filter. Depending on the manufacturer, 10pF to 20pF capacitors typically exhibit self resonance at the RF frequencies of interest. These capacitors, when placed at the input pins, can effectively shunt the RF noise to ground. For these capacitors to be effective, they must have a low-impedance, low-inductance path to the ground plane. Avoid using microvias to connect to the ground plane whenever possible as these vias do not conduct well at RF frequencies.

Startup/Shutdown Sequencing

To ensure proper device initialization and minimal click-and-pop, program the IC's $\overline{\text{SHDN}} = 1$ after configuring all registers. [Table 37](#) lists an example startup sequence for the device. To shut down the IC, simply set $\overline{\text{SHDN}} = 0$.

Table 37. Example Startup Sequence

SEQUENCE	DESCRIPTION	REGISTERS
1	Ensure $\overline{\text{SHDN}} = 0$	0x51
2	Configure clocks	0x10 to 0x13, 0x19 to 0x1B
3	Configure digital audio interface	0x14 to 0x17, 0x1C to 0x1F
4	Configure digital signal processing	0x18, 0x20, 0x3F to 0x46
5	Load coefficients	0x52 to 0xC9
6	Configure mixers	0x22 to 0x2D
7	Configure gain and volume controls	0x2E to 0x3E
8	Configure miscellaneous functions	0x47 to 0x4B
9	Enable desired functions	0x4C, 0x50
10	Set $\overline{\text{SHDN}} = 1$	0x51

MAX98088

Stereo Audio Codec with FlexSound Technology

Many configuration options in the ICs can be made while the devices are operating, however, some registers should only be adjusted when the corresponding audio path is disabled. [Table 38](#) lists the registers that are sensitive during operation. Either disable the corresponding audio path or set SHDN = 0 while changing these registers.

Component Selection

Optional Ferrite Bead Filter

In applications where speaker leads exceed 20mm, additional EMI suppression can be achieved by using a filter constructed from a ferrite bead and a capacitor to ground ([Figure 41](#)). Use a ferrite bead with low DC resistance, high-frequency (> 600MHz) impedance between 100Ω and 600Ω, and rated for at least 1A. The capacitor value varies based on the ferrite bead chosen and the actual speaker lead length. Select a capacitor less than 1nF based on EMI performance.

Input Capacitor

An input capacitor, C_{IN}, in conjunction with the input impedance of the IC line inputs forms a highpass filter

that removes the DC bias from an incoming analog signal. The AC coupling capacitor allows the amplifier to automatically bias the signal to an optimum DC level. Assuming zero-source impedance, the -3dB point of the highpass filter is given by:

$$f_{-3dB} = \frac{1}{2\pi R_{IN} C_{IN}}$$

Choose C_{IN} so that f_{-3dB} is well below the lowest frequency of interest. For best audio quality use capacitors whose dielectrics have low-voltage coefficients, such as tantalum or aluminum electrolytic. Capacitors with high-voltage coefficients, such as ceramics, may result in increased distortion at low frequencies.

Charge-Pump Capacitor Selection

Use capacitors with an ESR less than 100mΩ for optimum performance. Low-ESR ceramic capacitors minimize the output resistance of the charge pump. Most surface-mount ceramic capacitors satisfy the ESR requirement. For best performance over the extended temperature range, select capacitors with an X7R dielectric.

Table 38. Registers That Are Sensitive to Changes During Operation

REGISTER	DESCRIPTION
0x10 to 0x13, 0x19 to 0x1B	Clock Control Registers
0x14 to 0x17, 0x1C to 0x1F	Digital Audio Interface Configuration
0x18, 0x20	Digital Passband Filters
0x25 to 0x2D	Analog Mixers
0x52 to 0xC9	Digital Signal Processing Coefficients

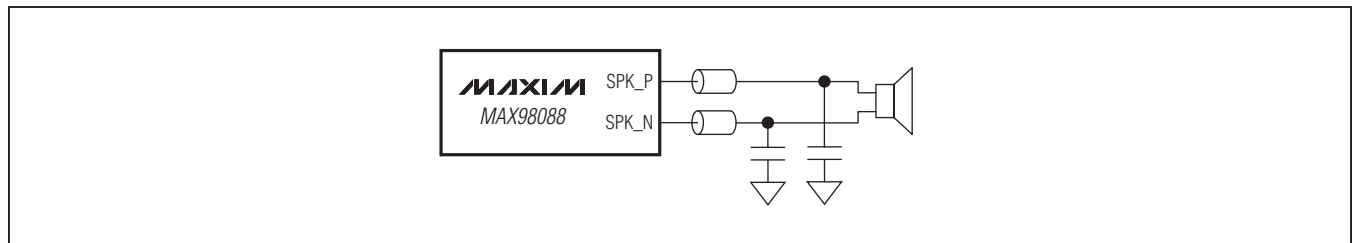

Figure 41. Optional Class D Ferrite Bead Filter

Stereo Audio Codec with FlexSound Technology

Charge-Pump Flying Capacitor

The value of the flying capacitor (connected between C1N and C1P) affects the output resistance of the charge pump. A value that is too small degrades the device's ability to provide sufficient current drive, which leads to a loss of output voltage. Increasing the value of the flying capacitor reduces the charge-pump output resistance to an extent. Above 1 μ F, the on-resistance of the internal switches and the ESR of external charge-pump capacitors dominate.

Charge-Pump Holding Capacitor

The holding capacitor (bypassing HPVSS) value and ESR directly affect the ripple at HPVSS. Increasing the capacitor's value reduces output ripple. Likewise, decreasing the ESR reduces both ripple and output resistance. Lower capacitance values can be used in systems with low maximum output power levels. See the Output Power vs. Load Resistance graph in the [Typical Operating Characteristics](#) section for more information

Unused Pins

[Table 39](#) shows how to connect the IC's pins when unused.

Table 39. Unused Pins

NAME	CONNECTION	NAME	CONNECTION
SPKRP	Unconnected	INB1	Unconnected
SPKRVDD	Always connect	INA2/MICEXTN	Unconnected
SPKLVDD	Always connect	LRCLKS2	Unconnected
SPKLP	Unconnected	MCLK	Always connect
RECNRXINN	Unconnected	SDINS2	AGND
HPVDD	Unconnected	IRQ	Unconnected
C1P	Unconnected	MIC1P/DIGMICDATA	Unconnected
HPGND	AGND	INA1/MICEXTP	Unconnected
SPKRN	Unconnected	DGND	Always connect
SPKRGND	Always connect	BCLKS2	Unconnected
SPKLGND	Always connect	SDA	Always connect
SPKLN	Unconnected	SCL	Always connect
RECP/RXINP	Unconnected	REG	Always connect
C1N	Unconnected	REF	Always connect
HPL	Unconnected	MIC1N/DIGMICCLK	Unconnected
HPVSS	Unconnected	MIC2P	Unconnected
SDINS1	AGND	SDOUTS2	Unconnected
LRCLKS1	Unconnected	DVDDS2	DVDD
HPSNS	AGND	DVDD	Always connect
INB2	Unconnected	AVDD	Always connect
HPR	Unconnected	PVDD	Always connect
DVDDS1	DVDD	AGND	Always connect
SDOUTS1	Unconnected	MICBIAS	Unconnected
BCLKS1	Unconnected	MIC2N	Unconnected
JACKSNS	Unconnected		

Stereo Audio Codec with FlexSound Technology

Recommended PCB Routing

The IC uses a 63-bump WLP package. [Figure 42](#) provides an example of how to connect to all active bumps using 3 layers of the PCB. To ensure uninterrupted ground returns, use layer 2 as a connecting layer between layer 1 and layer 2 and flood the remaining area with ground.

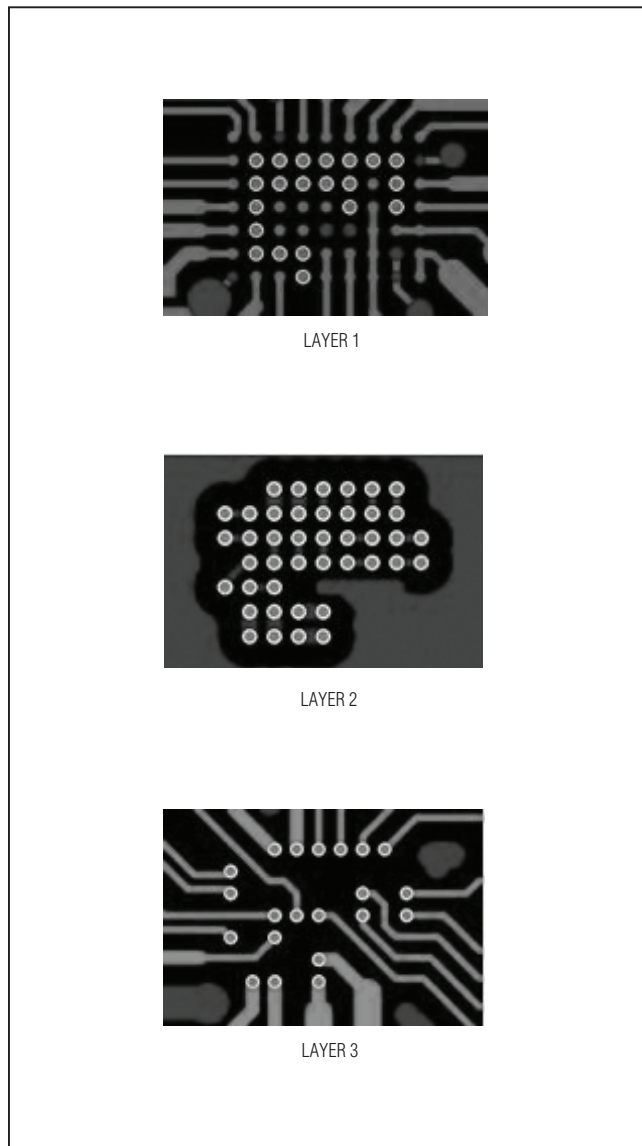

Figure 42. Suggested Routing for the MAX98088

Supply Bypassing, Layout, and Grounding

Proper layout and grounding are essential for optimum performance. When designing a PCB for the ICs, partition the circuitry so that the analog sections of the IC are separated from the digital sections. This ensures that the analog audio traces are not routed near digital traces.

Use a large continuous ground plane on a dedicated layer of the PCB to minimize loop areas. Connect AGND, DGND, HPGND, SPKLGND, and SPKRGND directly to the ground plane using the shortest trace length possible. Proper grounding improves audio performance, minimizes crosstalk between channels, and prevents any digital noise from coupling into the analog audio signals.

Ground the bypass capacitors on MICBIAS, REG, and REF directly to the ground plane with minimum trace length. Also be sure to minimize the path length to AGND. Bypass AVDD directly to AGND.

Connect all digital I/O termination to the ground plane with minimum path length to DGND. Bypass DVDD, DVDDS1, and DVDDS2 directly to DGND.

Place the capacitor between C1P and C1N as close as possible to the ICs to minimize trace length from C1P to C1N. Inductance and resistance added between C1P and C1N reduce the output power of the headphone amplifier. Bypass HPVDD and HPVSS with a capacitor located close to HPVSS with a short trace length to HPGND. Close decoupling of HPVSS minimizes supply ripple and maximizes output power from the headphone amplifier.

HPSNS senses ground noise on the headphone jack and adds the same noise to the output audio signal, thereby making the output (headphone output minus ground) noise free. Connect HPSNS to the headphone jack shield to ensure accurate pickup of headphone ground noise.

Bypass SPKLVDD and SPKRVDD to SPKLGND and SPKRGND, respectively, with as little trace length as possible. Connect SPKLP, SPKLN, SPKRP, and SPKRN to the stereo speakers using the shortest traces possible. Reducing trace length minimizes radiated EMI. Route SPKLP/SPKLN and SPKRP/SPKRN as differential pairs on the PCB to minimize loop area, thereby the inductance of the circuit. If filter components are used on the speaker outputs, be sure to locate them as close as possible to the IC to ensure maximum effectiveness. Minimize the trace length from any ground-connected passive components to SPKLGND and SPKRGND to further minimize radiated EMI.

MAX98088

Stereo Audio Codec with FlexSound Technology

Route microphone signals from the microphone to the ICs as a differential pair, ensuring that the positive and negative signals follow the same path as closely as possible with equal trace length. When using single-ended microphones or other single-ended audio sources, ground the negative microphone input as close as possible to the audio source and then treat the positive and negative traces as differential pairs.

An evaluation kit (EV kit) is available to provide an example layout for the IC. The EV kit allows quick setup of the IC and includes easy-to-use software allowing all internal registers to be controlled.

WLP Applications Information

For the latest application details on WLP construction, dimensions, tape carrier information, PCB techniques, bump-pad layout, and recommended reflow temperature profile, as well as the latest information on reliability testing results, refer to the Application Note 1891: *Wafer-Level Packaging (WLP) and Its Applications*. [Figure 43](#) shows the dimensions of the WLP balls used on the MAX98088.

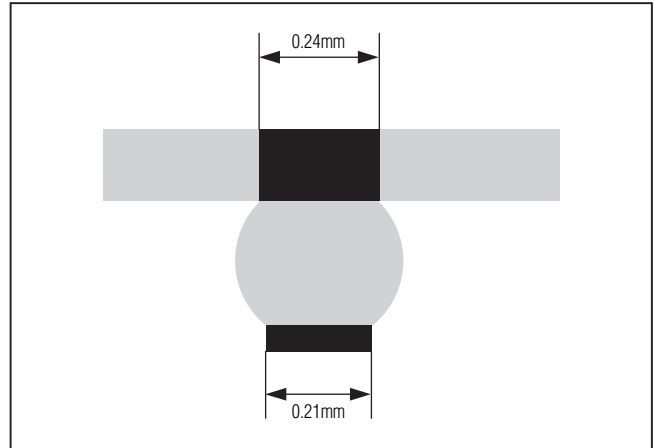

Figure 43. WLP Ball Dimensions

Ordering Information

PART	TEMP RANGE	PIN-PACKAGE
MAX98088EWY+	-40°C to +85°C	63 WLP

+Denotes lead(Pb)-free/RoHS-compliant package.

MAX98088

Stereo Audio Codec with FlexSound Technology

Package Information

For the latest package outline information and land patterns (footprints), go to www.maxim-ic.com/packages. Note that a "+", "#", or "-" in the package code indicates RoHS status only. Package drawings may show a different suffix character, but the drawing pertains to the package regardless of RoHS status.

PACKAGE TYPE	PACKAGE CODE	OUTLINE NO.	LAND PATTERN NO.
63 WLP	W633A3+1	21-0462	Refer to Application Note 1891

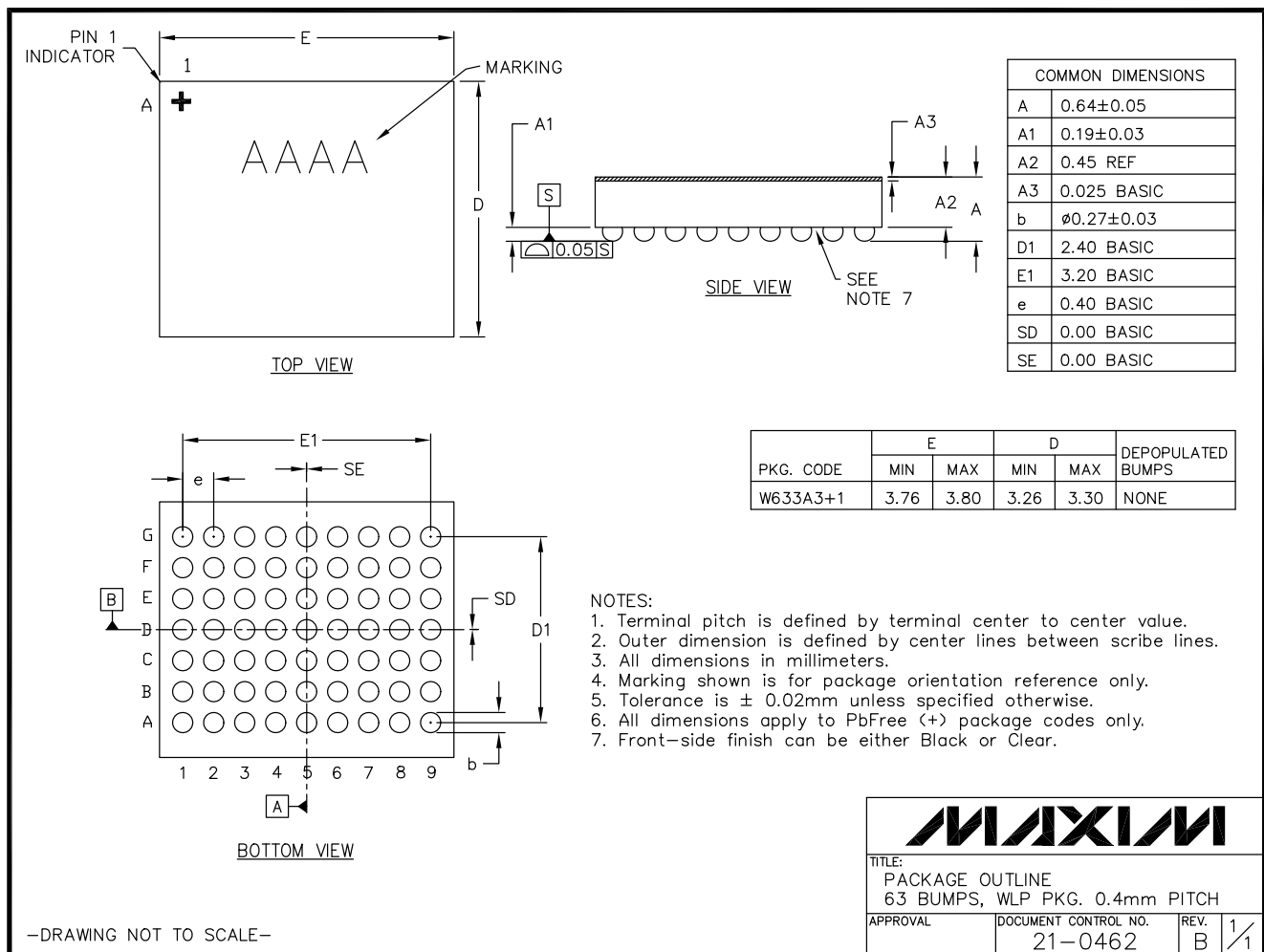

MAX98088

Stereo Audio Codec with FlexSound Technology

Revision History

REVISION NUMBER	REVISION DATE	DESCRIPTION	PAGES CHANGED
0	6/10	Initial release	—
1	6/11	Made various updates, replaced TOCs 56 and 68	1, 5–27, 29, 30, 33, 35, 37, 39, 41, 43, 46, 54, 55, 56, 63–67, 69, 70, 70, 74, 75, 77, 80, 81, 83–86, 90, 94–99, 101, 103, 104, 105, 107, 109, 110, 111, 113, 114, 119, 120

Maxim cannot assume responsibility for use of any circuitry other than circuitry entirely embodied in a Maxim product. No circuit patent licenses are implied. Maxim reserves the right to change the circuitry and specifications without notice at any time. The parametric values (min and max limits) shown in the Electrical Characteristics table are guaranteed. Other parametric values quoted in this data sheet are provided for guidance.

Maxim Integrated Products, 120 San Gabriel Drive, Sunnyvale, CA 94086 408-737-7600 _____ **123**

Looking for pricing, stock, or lifecycle information?

Click below to explore more details on WIN SOURCE:

- ⊖ [View MAX98088EWY+T on WIN SOURCE](#)
- ⊖ [Maxim Integrated Information](#)

Optimize Your Supply Chain with WIN SOURCE Solutions

- ✓ Global Sourcing Solution
- ✓ Obsolete Management
- ✓ Cost Control Management
- ✓ Shortage Management
- ✓ Alternative Solution
- ✓ Excess Inventory Management