



**THE DATASHEET OF
MAX9773ETG+**





1.8W, Filterless, Ultra-Low EMI, Stereo Class D Audio Power Amplifier

General Description

The MAX9773 3rd-generation, ultra-low EMI, stereo, Class D audio power amplifier provides Class AB performance with Class D efficiency. The MAX9773 delivers 1.8W per channel into a 4Ω load, and offers efficiencies above 90%. Active emissions limiting (AEL) circuitry greatly reduces EMI by actively controlling the output FET gate transitions under all possible transient conditions. AEL controls high-frequency emissions resulting from conventional Class D free-wheeling behavior in the presence of an inductive load. Zero-dead-time (ZDT) technology maintains state-of-the-art efficiency and THD+N performance by allowing the output FETs to switch simultaneously without cross conduction. A spread-spectrum modulation scheme eliminates the need for output filtering found in traditional Class D devices. These design concepts reduce component count and extend battery life.

The MAX9773 offers two modulation schemes: a fixed-frequency (FFM) mode, and a spread-spectrum (SSM) mode that reduces EMI-radiated emissions. The MAX9773 oscillator can be synchronized to an external clock through the SYNC input, allowing synchronization of multiple Maxim Class D amplifiers. The sync output (SYNC_OUT) can be used for a master-slave application where more channels are required. The MAX9773 features a fully differential architecture, a full bridge-tied load (BTL) output, and comprehensive click-and-pop suppression. The device features internally set gains of 12dB, 15.6dB, 20dB, and 26dB selected through two gain-select inputs, further reducing external component count.

The MAX9773 features high 80dB PSRR, less than 0.1% THD+N, and SNR in excess of 88dB. Short-circuit and thermal-overload protection prevent the device from being damaged during a fault condition. The MAX9773 is available in 24-pin thin QFN-EP (4mm x 4mm x 0.8mm), and 20-bump UCSP™ (2mm x 2.5mm x 0.6mm) packages. The MAX9773 is specified over the extended -40°C to +85°C temperature range.

Applications

Cellular/Multimedia Phones
Notebooks
Handheld Gaming Consoles
MP3 Players

Pin Configurations and Gain Selection appear at end of data sheet.

UCSP is a trademark of Maxim Integrated Products, Inc.



Features

- ◆ Filterless Amplifier Passes FCC-Radiation Emissions Standards with 6in of Cable
- ◆ Unique Spread-Spectrum Mode and Active Emissions Limiting Achieves Better than 15dB Margin Under FCC Limit
- ◆ Zero Dead Time (ZDT) H-Bridge Maintains Good THD+N Performance
- ◆ Single-Supply Operation (2.5V to 5.5V)
- ◆ Stereo Output (4Ω, V_{DD} = 5V, THD+N = 1%, P_{OUT} = 1.8W)
- ◆ No LC Output Filter Required
- ◆ 85% Efficiency (R_L = 8Ω, P_O = 600mW)
- ◆ Less Than 0.1% THD+N
- ◆ High 80dB PSRR
- ◆ Fully Differential Inputs
- ◆ Integrated Click-and-Pop Suppression
- ◆ Low-Power Shutdown Mode (0.1μA)
- ◆ Short-Circuit and Thermal-Overload Protection
- ◆ Pin-for-Pin Compatible with the MAX9701
- ◆ Available in Thermally Efficient, Space-Saving Packages
 - 24-Pin TQFN-EP (4mm x 4mm x 0.8mm)
 - 20-Bump UCSP (2mm x 2.5mm x 0.6mm)

Ordering Information

PART	TEMP RANGE	PIN-PACKAGE	PKG CODE
MAX9773EBP-T	-40°C to +85°C	20 UCSP-20	B20-1
MAX9773ETG+	-40°C to +85°C	24 TQFN-EP*	T2444-4

+Denotes lead-free package.

*EP = Exposed paddle.

Block Diagram

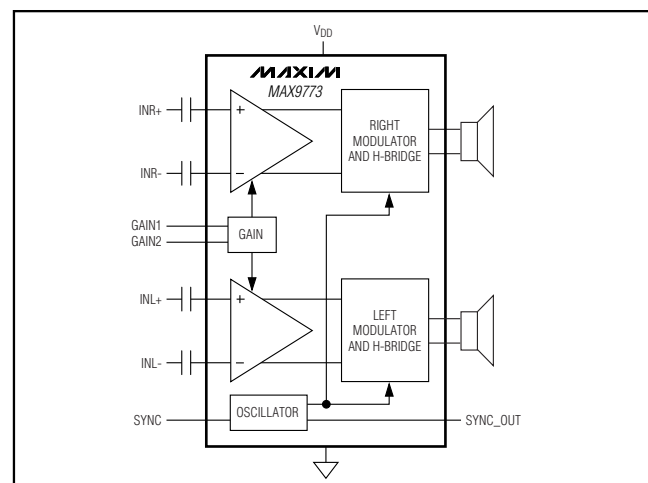

1.8W, Filterless, Ultra-Low EMI, Stereo Class D Audio Power Amplifier

ABSOLUTE MAXIMUM RATINGS

V _{DD} to GND6V
V _{DD} to PV _{DD}-0.3V to +0.3V
PV _{DD} to PGND6V
GND to PGND-0.3V to +0.3V
All Other Pins to GND-0.3V to (V _{DD} + 0.3V)
Continuous Current In/Out of PV _{DD} , PGND, OUT ₋±800mA
Continuous Input Current (all other pins)±20mA
Duration of OUT ₋ Short Circuit to V _{DD} /GND/PV _{DD} /PGNDContinuous

Duration of Short Circuit Between OUT+ and OUT-Continuous
Continuous Power Dissipation (T _A = +70°C)800mW
20-Bump UCSP (derate 10mW/°C above +70°C)800mW
24-Pin Thin QFN (derate 20.8mW/°C above +70°C)1666.7mW
Junction Temperature+150°C
Operating Temperature Range-40°C to +85°C
Storage Temperature Range-65°C to +150°C
Bump Temperature (soldering) Reflow+235°C
Lead Temperature (soldering, 10s)+300°C

Stresses beyond those listed under "Absolute Maximum Ratings" may cause permanent damage to the device. These are stress ratings only, and functional operation of the device at these or any other conditions beyond those indicated in the operational sections of the specifications is not implied. Exposure to absolute maximum rating conditions for extended periods may affect device reliability.

ELECTRICAL CHARACTERISTICS

(V_{DD} = V_{PVDD} = V_{SHDN} = 3.3V, V_{GND} = V_{PGND} = 0V, SYNC = 0V (FFM), gain = 12dB (GAIN1 = 1, GAIN2 = 1), R_L connected between OUT+ and OUT-, R_L = ∞, T_A = T_{MIN} to T_{MAX}, unless otherwise noted. Typical values are at T_A = +25°C.) (Notes 1, 2)

PARAMETER	SYMBOL	CONDITIONS	MIN	TYP	MAX	UNITS
GENERAL						
Supply Voltage Range	V _{DD}	Inferred from PSRR test	2.6		5.5	V
Quiescent Current	I _{DD}	Per channel		5.5	7.5	mA
Shutdown Current	I _{SHDN}			0.1	10	μA
Common-Mode Rejection Ratio	CMRR	f _{IN} = 1kHz		66		dB
Input Bias Voltage	V _{BIAS}		1.125	1.25	1.375	V
Turn-On Time	t _{ON}			80		ms
Output Offset Voltage	V _{OS}	T _A = +25°C		±10	±50	mV
Power-Supply Rejection Ratio	PSRR	V _{DD} = 2.5V to 5.5V, V _{IN} = 0V, T _A = +25°C	59	80		dB
		T _{MIN} < T _A < T _{MAX}	56			
		100mV _{P-P} ripple, V _{IN} = 0V				
Output Power (Note 3)	P _{OUT}	THD+N = 1%, T _A = +25°C	V _{DD} = 3.3V	R _L = 8Ω	500	mW
				R _L = 4Ω	750	
		V _{DD} = 5V	R _L = 8Ω	1300		
			R _L = 4Ω	1800		
Total Harmonic Distortion Plus Noise (Note 3)	THD+N	R _L = 8Ω (P _{OUT} = 400mW), f = 1kHz	0.04		%	
		R _L = 4Ω (P _{OUT} = 600mW), f = 1kHz	0.08			
Signal-to-Noise Ratio	SNR	V _{OUT} = 1V _{RMS}	BW = 22Hz to 22kHz	FFM	86	dB
				SSM	86	
			A-weighted	FFM	88.5	
				SSM	88.5	
Oscillator Frequency	f _{OSC}	SYNC = GND, T _A = +25°C	950	1100	1250	kHz
		SYNC = unconnected, T _A = +25°C	1200	1400	1600	
		SYNC = V _{DD} , T _A = +25°C	1200 ±60			
Minimum On-Time	t _{MIN}		200		ns	
SYNC Frequency Lock Range	f _{SYNC}		1000	2000		kHz

1.8W, Filterless, Ultra-Low EMI, Stereo Class D Audio Power Amplifier

MAX9773

ELECTRICAL CHARACTERISTICS (continued)

($V_{DD} = V_{PVDD} = V_{SHDN} = 3.3V$, $V_{GND} = V_{PGND} = 0V$, $SYNC = 0V$ (FFM), gain = 12dB (GAIN1 = 1, GAIN2 = 1), R_L connected between OUT+ and OUT-, $R_L = \infty$, $T_A = T_{MIN}$ to T_{MAX} , unless otherwise noted. Typical values are at $T_A = +25^\circ C$.) (Notes 1, 2)

PARAMETER	SYMBOL	CONDITIONS	MIN	TYP	MAX	UNITS
SYNC_OUT Capacitance Drive	C_{SYNC_OUT}			100		pF
Capacitive Drive	C_L	Bridge-tied capacitance		200		pF
		Single ended		400		
Click-and-Pop Level	K_{CP}	Peak reading, A-weighted, 32 samples per second (Note 4)	Into shutdown		-50	dBV
			Out of shutdown		-50	
Efficiency	η	$P_{OUT} = 600mW$ per channel, $f_{IN} = 1kHz$, $R_L = 8\Omega$		85		%
Input Resistance	R_{IN}	GAIN1 = 0, GAIN2 = 0	10	16		k Ω
		GAIN1 = 1, GAIN2 = 0		30		
		GAIN1 = 0, GAIN2 = 1		45		
		GAIN1 = 1, GAIN2 = 1		60		
Gain	A_V	GAIN1 = 0, GAIN2 = 0		26		dB
		GAIN1 = 1, GAIN2 = 0		20		
		GAIN1 = 0, GAIN2 = 1		15.6		
		GAIN1 = 1, GAIN2 = 1		12		
Channel-to-Channel Gain Tracking			1			%
Crosstalk		L to R, R to L, $f = 10kHz$, $R_L = 8\Omega$, $P_{OUT} = 300mW$		80		dB
DIGITAL INPUTS (SHDN, SYNC, GAIN1, GAIN2)						
Input-Voltage High	V_{INH}		2			V
Input-Voltage Low	V_{INL}				0.8	V
Input Leakage Current (SHDN, GAIN1, GAIN2)					± 1	μA
Input Leakage Current (SYNC)		$V_{SYNC} = GND$, normal operation	-15	-7		μA
		$V_{SYNC} = V_{DD}$, normal operation		12	25	
DIGITAL OUTPUTS (SYNC_OUT)						
Output-Voltage High	V_{OH}	$I_{OH} = 3mA$, $V_{DD} = 3.3V$	2.4			V
Output-Voltage Low	V_{OL}	$I_{OL} = 3mA$			0.4	V

Note 1: All devices are 100% production tested at $+25^\circ C$. All temperature limits are guaranteed by design.

Note 2: Testing performed with a resistive load in series with an inductor to simulate an actual speaker load. For $R_L = 4\Omega$, $L = 33\mu H$. For $R_L = 8\Omega$, $L = 68\mu H$.

Note 3: When driving speakers below 4Ω with large signals, exercise care to avoid violating the absolute maximum rating for continuous output current.

Note 4: Testing performed with 8Ω resistive load in series with $68\mu H$ inductive load connected across the BTL output. Mode transitions are controlled by \overline{SHDN} . K_{CP} level is calculated as: $20 \times \log[(\text{peak voltage during mode transition, no input signal})]$. Units are expressed in dBV.

1.8W, Filterless, Ultra-Low EMI, Stereo Class D Audio Power Amplifier

Typical Operating Characteristics

($V_{DD} = V_{PVDD} = V_{SHDN} = 3.3V$, $V_{GND} = V_{PGND} = 0V$, $SYNC = V_{DD}$ (SSM), gain = 12dB (GAIN1 = 1, GAIN2 = 1)).

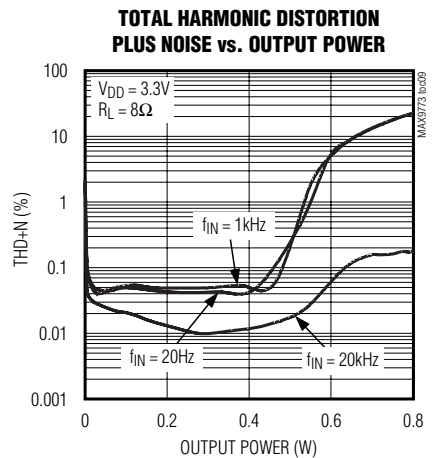
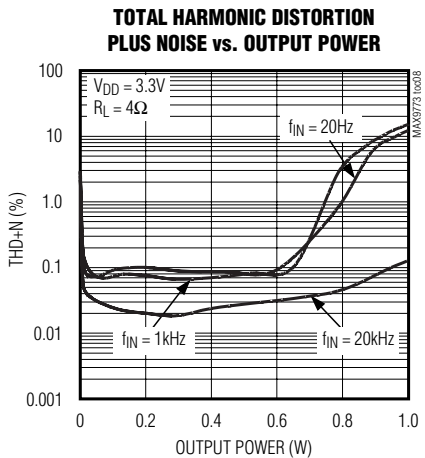
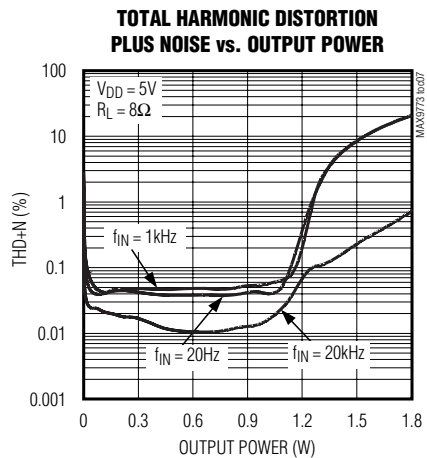
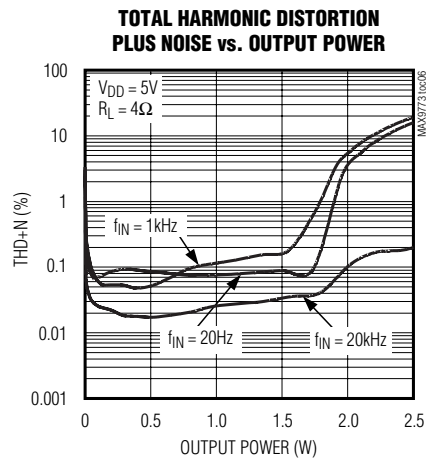
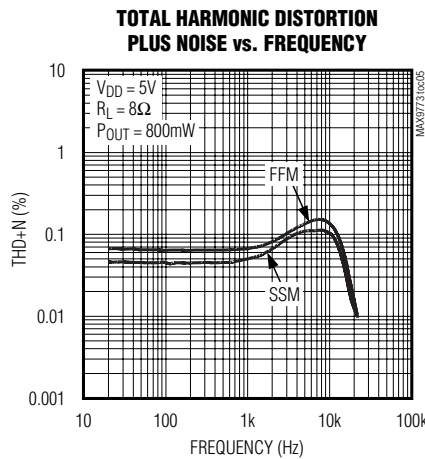
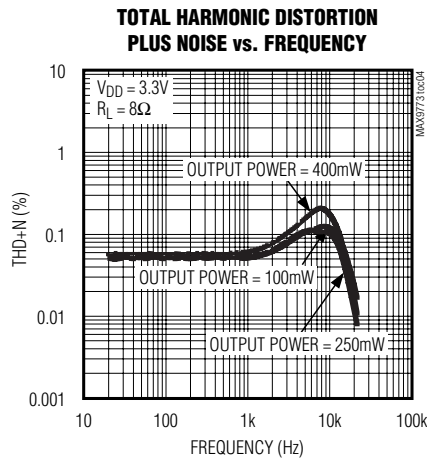
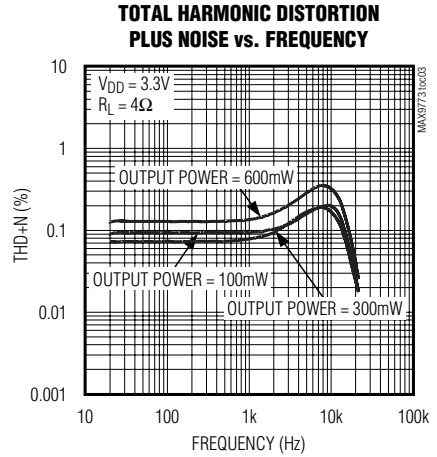
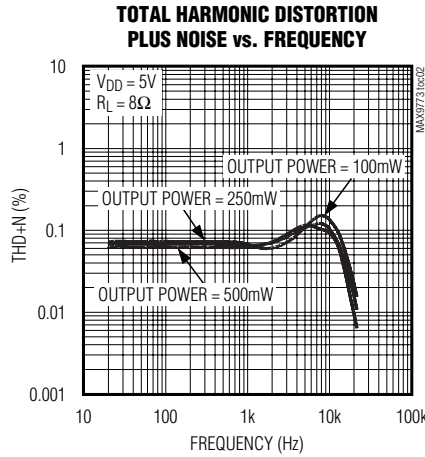
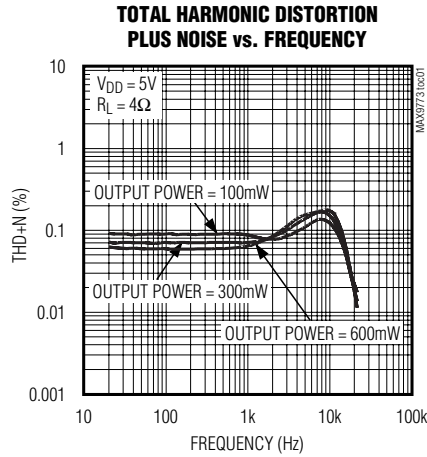

1.8W, Filterless, Ultra-Low EMI, Stereo Class D Audio Power Amplifier

MAX9773

Typical Operating Characteristics (continued)

($V_{DD} = V_{PVDD} = V_{SHDN} = 3.3V$, $V_{GND} = V_{PGND} = 0V$, $SYNC = V_{DD}$ (SSM), gain = 12dB (GAIN1 = 1, GAIN2 = 1)).

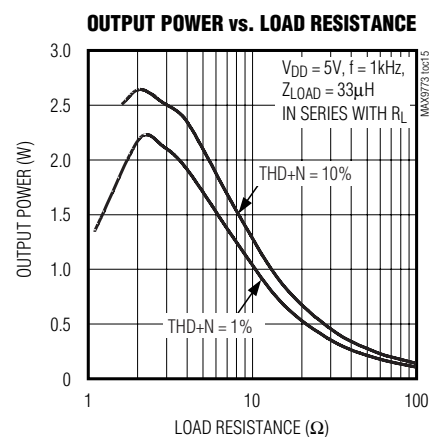
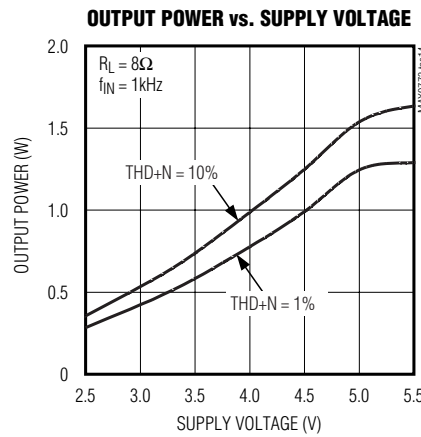
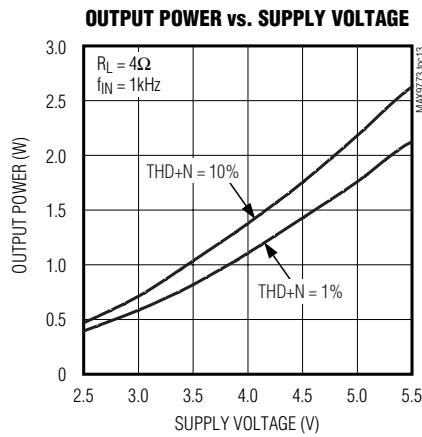
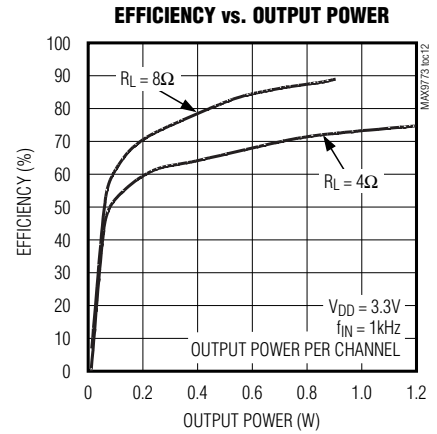
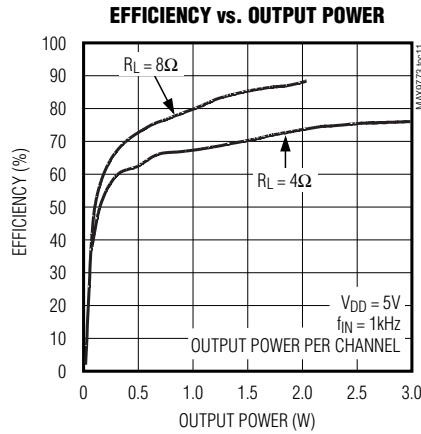
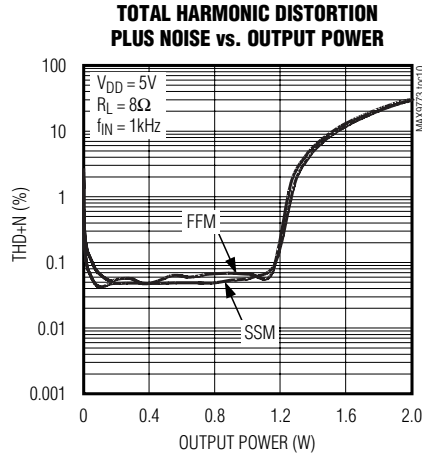

1.8W, Filterless, Ultra-Low EMI, Stereo Class D Audio Power Amplifier

Typical Operating Characteristics (continued)

($V_{DD} = V_{PVDD} = V_{SHDN} = 3.3V$, $V_{GND} = V_{PGND} = 0V$, $SYNC = V_{DD}$ (SSM), gain = 12dB (GAIN1 = 1, GAIN2 = 1)).

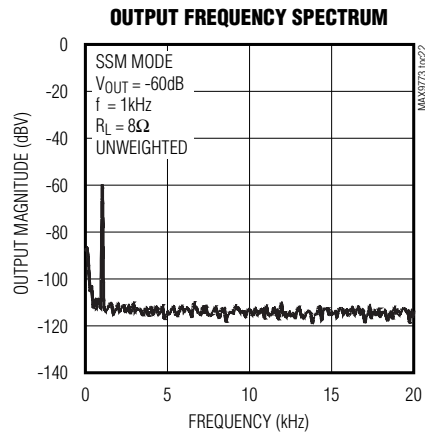
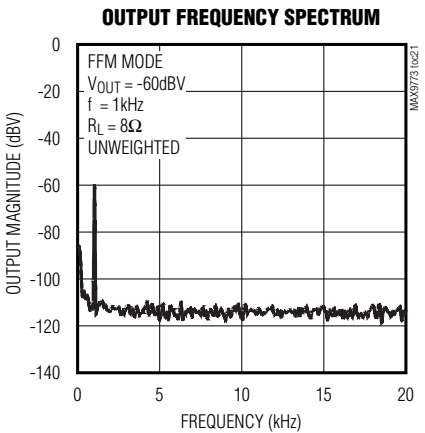
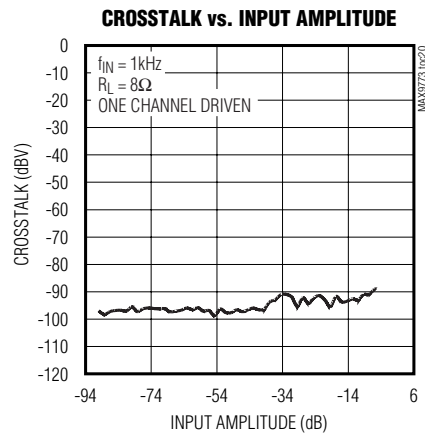
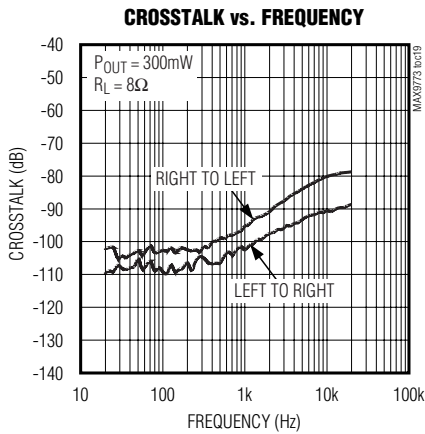
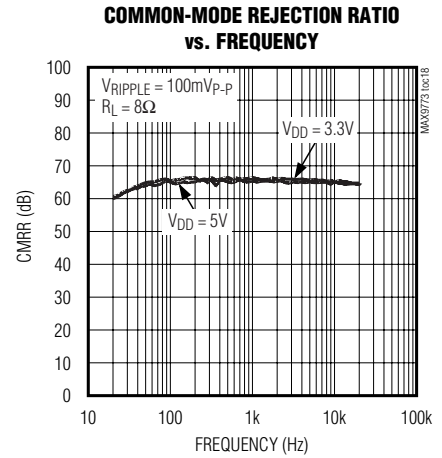
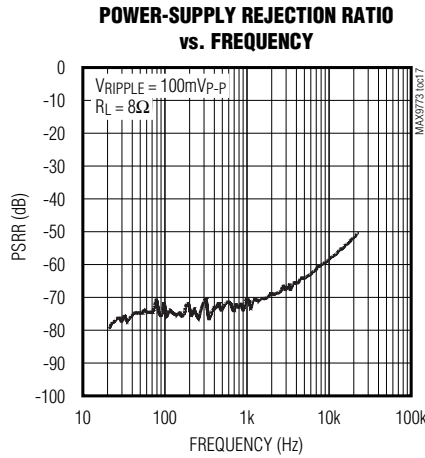
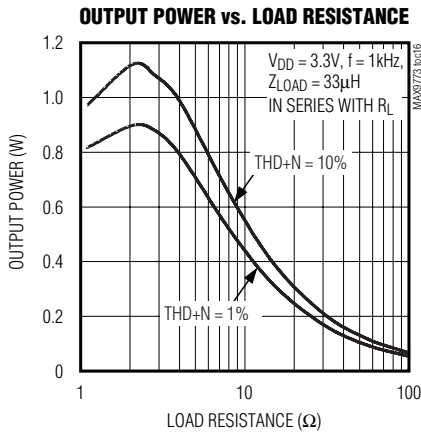

1.8W, Filterless, Ultra-Low EMI, Stereo Class D Audio Power Amplifier

MAX9773

Typical Operating Characteristics (continued)

($V_{DD} = V_{PVDD} = V_{SHDN} = 3.3V$, $V_{GND} = V_{PGND} = 0V$, $SYNC = V_{DD}$ (SSM), gain = 12dB (GAIN1 = 1, GAIN2 = 1)).

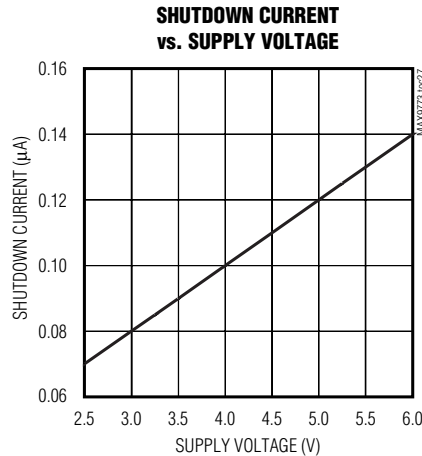
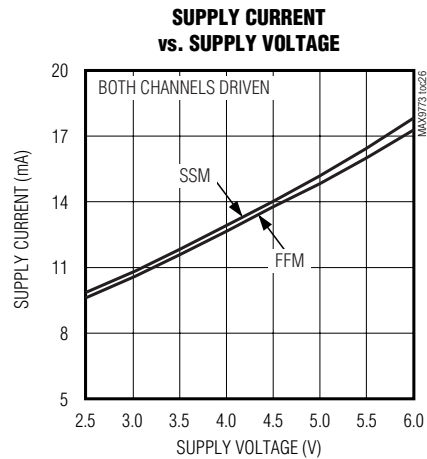
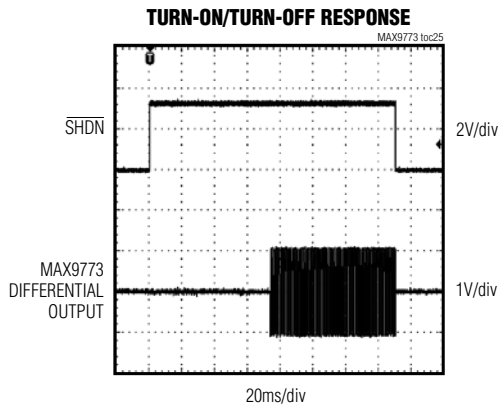
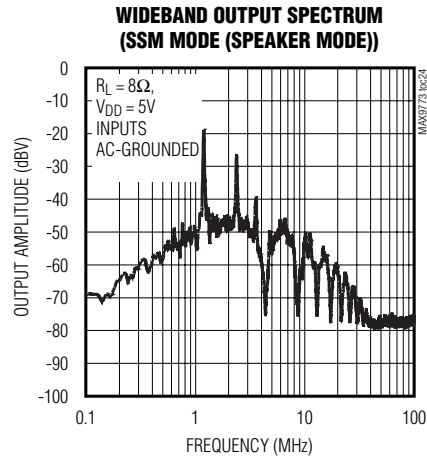
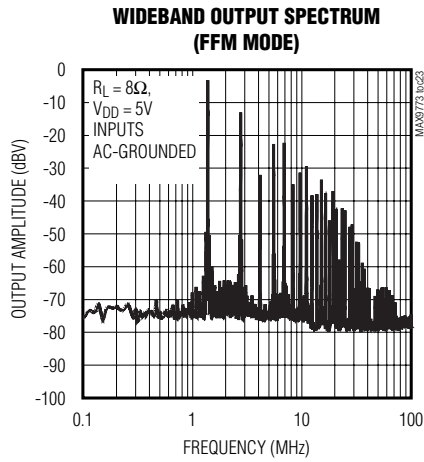

1.8W, Filterless, Ultra-Low EMI, Stereo Class D Audio Power Amplifier

Pin Description

PIN		NAME	FUNCTION
TQFN	UCSP		
1	A2	$\overline{\text{SHDN}}$	Active-Low Shutdown. Connect to V_{DD} for normal operation.
2	B3	SYNC	Frequency Select and External Clock Input: SYNC = GND: Fixed-frequency mode with $f_S = 1100\text{kHz}$. SYNC = Unconnected: Fixed-frequency mode with $f_S = 1400\text{kHz}$. SYNC = V_{DD} : Spread-spectrum mode with $f_S = 1200\text{kHz} \pm 60\text{kHz}$. SYNC = Clocked: Fixed-frequency mode with $f_S = \text{external clock frequency}$.
3, 8, 11, 16	—	N.C.	No Connection. Not internally connected.
4	A3	OUTL+	Left-Channel Amplifier Output Positive Phase
5, 14	A4, D4	PVDD	H-Bridge Power Supply. Connect to V_{DD} . Bypass with a $0.1\mu\text{F}$ capacitor to PGND.
6, 13	B4, C4	PGND	Power Ground
7	A5	OUTL-	Left-Channel Amplifier Output Negative Phase
9, 22	B1, B5	GND	Analog Ground
10	C5	SYNC_OUT	Clock Signal Output
12	D5	OUTR-	Right-Channel Amplifier Output Negative Phase
15	D3	OUTR+	Right-Channel Amplifier Output Positive Phase
17	C3	GAIN1	Gain-Select Input 1
18	D2	GAIN2	Gain-Select Input 2
19	D1	INR-	Right-Channel Inverting Input
20	C2	INR+	Right-Channel Noninverting Input
21	C1	V_{DD}	Analog Power Supply. Connect to PVDD. Bypass with a $10\mu\text{F}$ capacitor to GND.
23	B2	INL+	Left-Channel Noninverting Input
24	A1	INL-	Left-Channel Inverting Input
EP	—	EP	Exposed Pad. Connect the exposed thermal pad to the GND plane (see the <i>Supply Bypassing, Layout, and Grounding</i> section).

1.8W, Filterless, Ultra-Low EMI, Stereo Class D Audio Power Amplifier

Functional Diagram

MAX9773

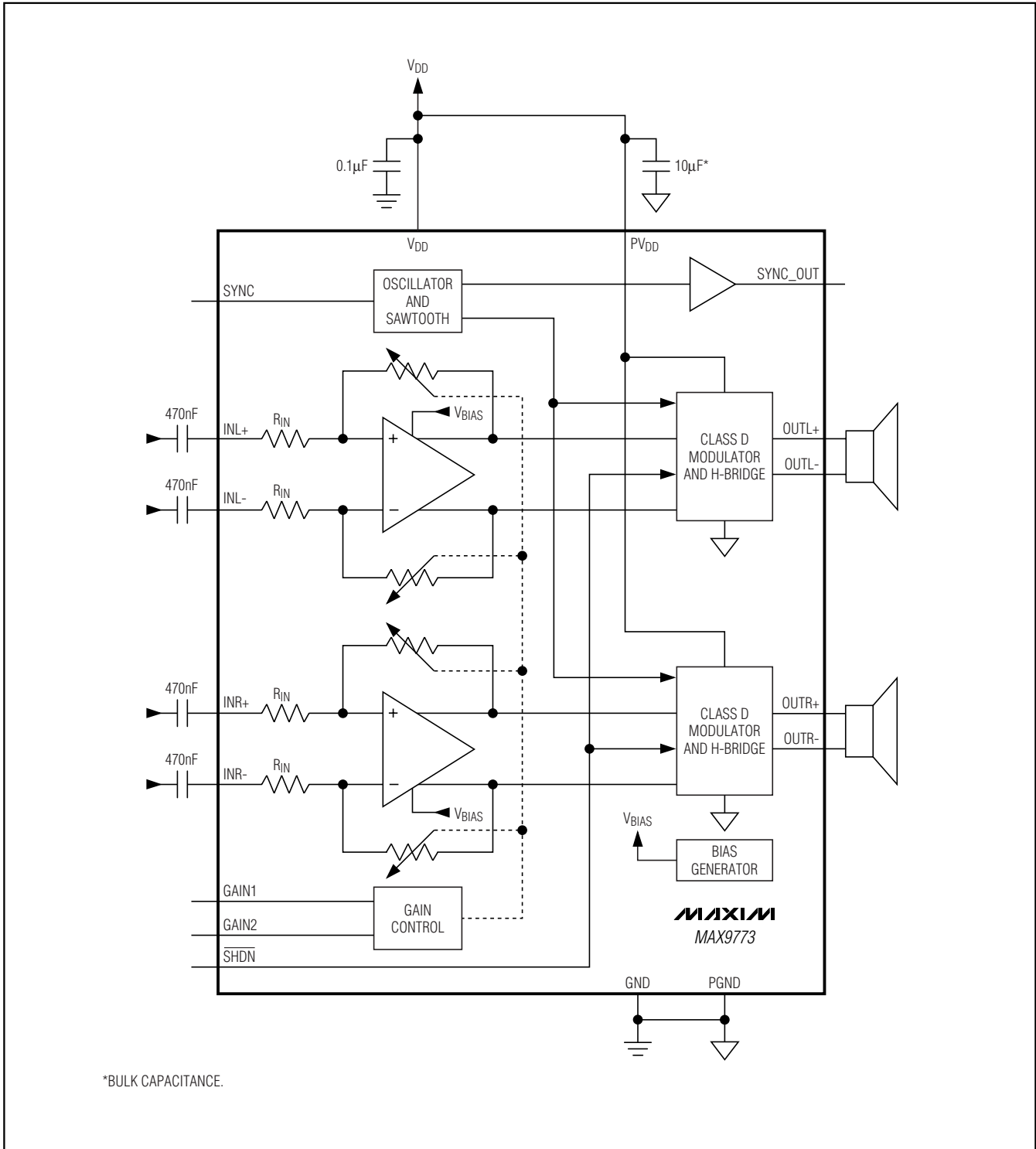

*BULK CAPACITANCE.

1.8W, Filterless, Ultra-Low EMI, Stereo Class D Audio Power Amplifier

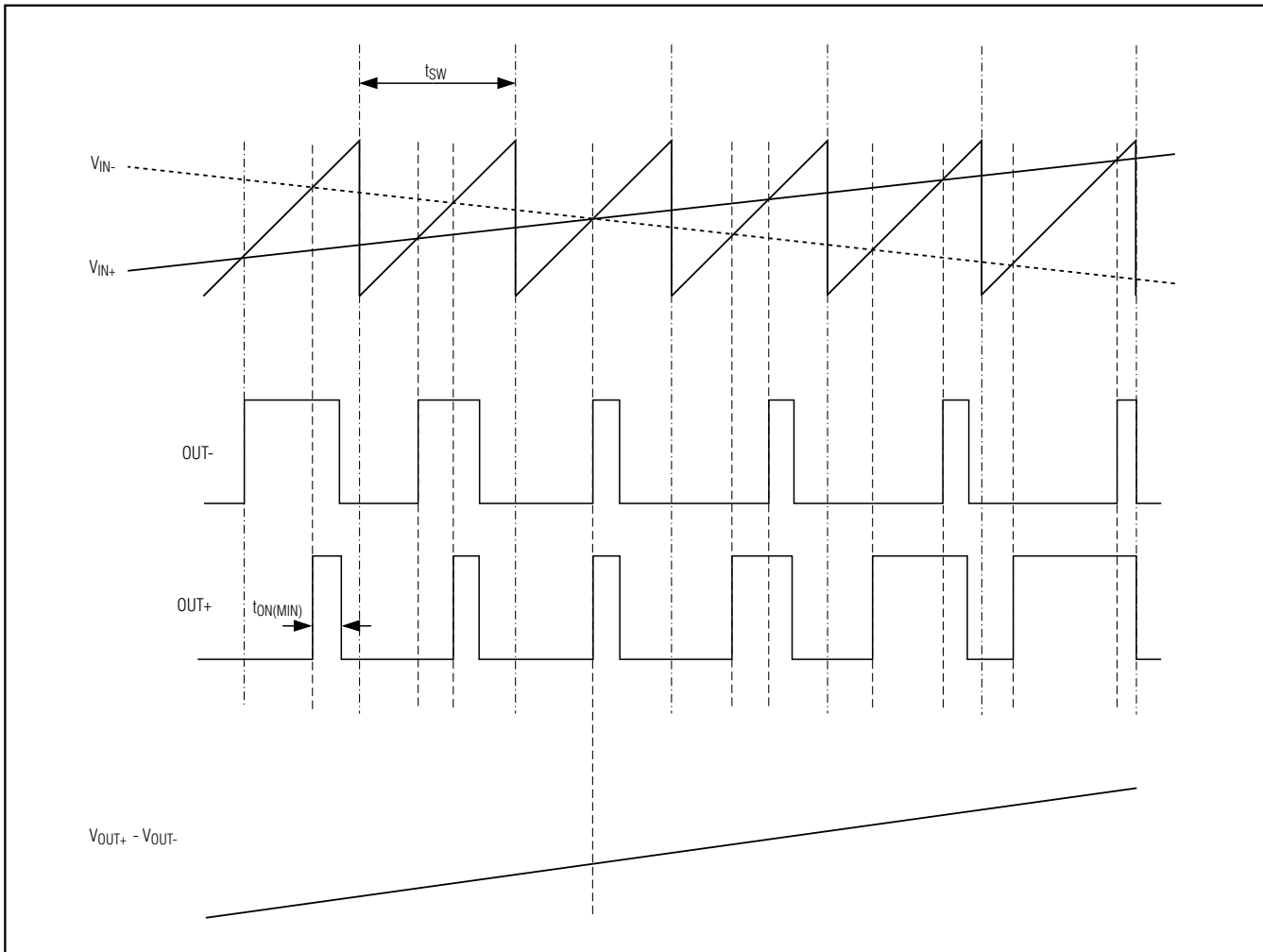

Figure 1. MAX9773 Outputs with an Input Signal Applied

Detailed Description

The MAX9773 ultra-low EMI, filterless, stereo Class D audio power amplifier incorporates several improvements to switch-mode amplifier topology. The MAX9773 features output-driver AEL circuitry to reduce EMI. Zero dead time technology maintains state-of-the-art efficiency and THD+N performance by allowing the output FETs to switch simultaneously without cross conduction. The MAX9773 offers Class AB performance with Class D efficiency, while occupying minimal board space. A unique, filterless modulation scheme, synchronizable switching frequency, and spread-spectrum switching mode create a compact, flexible, low-noise, efficient audio power amplifier. The differential input architecture reduces common-mode noise pickup, and can be used without

input-coupling capacitors. The inputs can also be configured to accept a single-ended input signal.

Comparators monitor the MAX9773 inputs and compare the complementary input voltages to the sawtooth waveform. The comparators trip when the input magnitude of the sawtooth exceeds their corresponding input voltage. Both comparators reset at a fixed time after the rising edge of the second comparator trip point, generating a minimum-width pulse ($t_{ON(MIN)}$) at the output of the second comparator (Figure 1). As the input voltage increases or decreases, the duration of the pulse at one output increases while the other output pulse duration remains the same. This causes the net voltage across the speaker ($V_{OUT+} - V_{OUT-}$) to change. The minimum-width pulse helps the device to achieve high levels of linearity.

1.8W, Filterless, Ultra-Low EMI, Stereo Class D Audio Power Amplifier

MAX9773

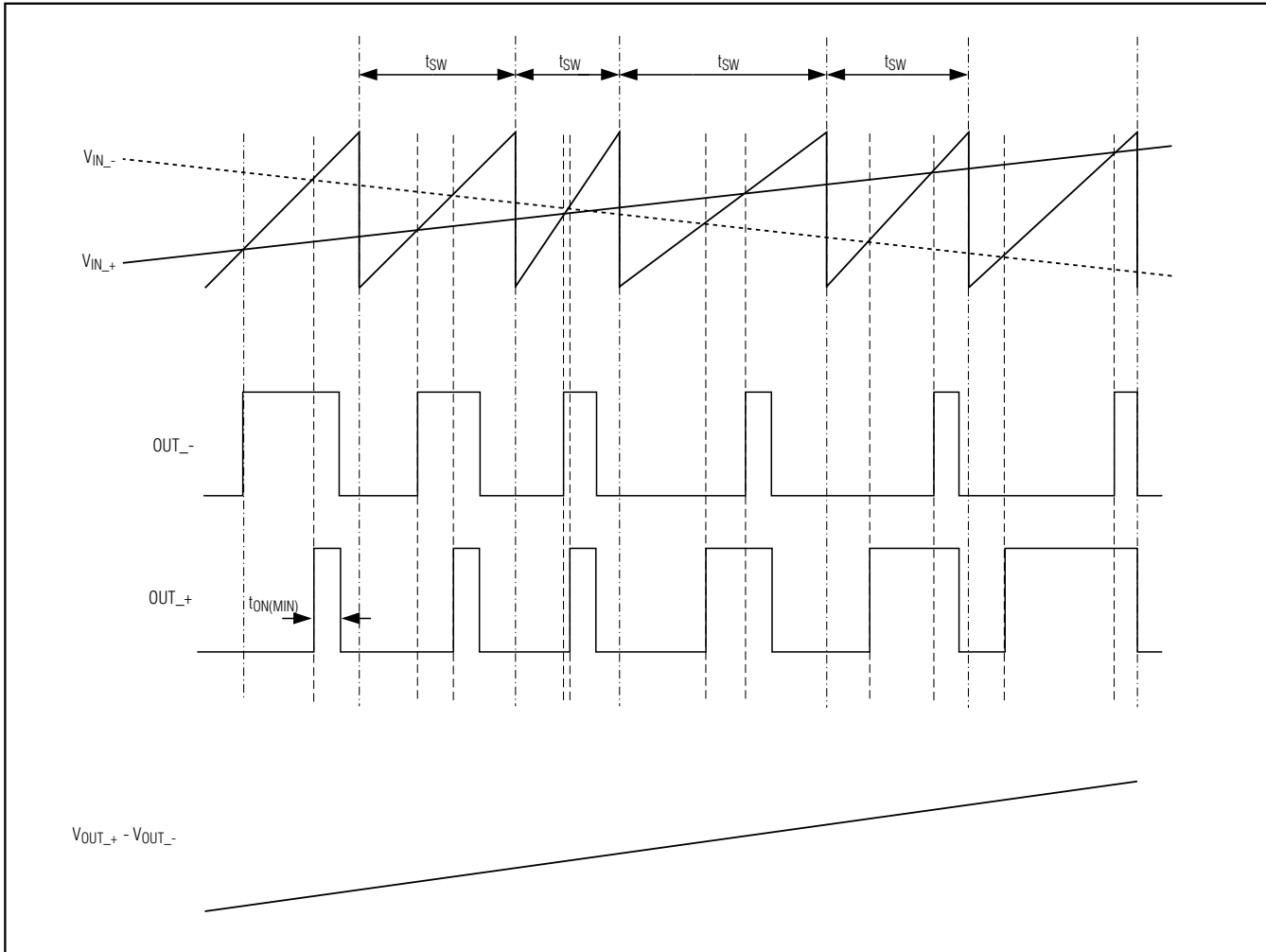

Figure 2. MAX9773 Outputs with an Input Signal Applied (SSM Mode)

Operating Modes

Fixed-Frequency (FFM) Mode

The MAX9773 features two fixed-frequency modes. Connect SYNC to GND to select a 1.1MHz switching frequency. Leave SYNC unconnected to select a 1.4MHz switching frequency. The frequency spectrum of the MAX9773 consists of the fundamental switching frequency and its associated harmonics (see the Wideband FFT graph in the *Typical Operating Characteristics*). Program the switching frequency so the harmonics do not fall within a sensitive frequency band (Table 1). Audio reproduction is not affected by changing the switching frequency.

Table 1. Operating Modes

SYNC	MODE
GND	FFM with $f_{OSC} = 1100\text{kHz}$
Unconnected	FFM with $f_{OSC} = 1400\text{kHz}$
VDD	SSM with $f_{OSC} = 1200\text{kHz} \pm 60\text{kHz}$
Clocked	FFM with $f_{OSC} = \text{external clock frequency}$

1.8W, Filterless, Ultra-Low EMI, Stereo Class D Audio Power Amplifier

Spread-Spectrum (SSM) Mode

The MAX9773 features a unique spread-spectrum mode that flattens the wideband spectral components, improving EMI emissions that may be radiated by the speaker and cables. This mode is enabled by connecting SYNC to V_{DD} (Table 1). In SSM mode, the switching frequency varies randomly by $\pm 60\text{kHz}$ around the center frequency (1.2MHz). The modulation scheme remains the same, but the period of the sawtooth waveform changes from cycle to cycle (Figure 2). Instead of a large amount of spectral energy present at multiples of the switching frequency, the energy is now spread over a bandwidth that increases with frequency. Above a few megahertz, the wideband spectrum looks like white noise for EMI purposes (Figure 3). A proprietary amplifier topology ensures this does not corrupt the noise floor in the audio bandwidth.

Synchronous Switching Mode SYNC

The SYNC input allows the MAX9773 to be synchronized to a user-defined clock, or another Maxim Class D amplifier, creating a fully synchronous system, minimizing clock intermodulation, and allocating spectral components of the switching harmonics to insensitive frequency bands. Applying a TTL clock signal between 1000kHz and 2000kHz to SYNC synchronizes the MAX9773. The period of the SYNC clock can be randomized, allowing

the MAX9773 to be synchronized to another Maxim Class D amplifier operating in SSM mode.

SYNC_OUT

SYNC_OUT allows several MAX9773s as well as other Class D amplifiers (such as the MAX9700) to be cascaded. The synchronized output minimizes interference due to clock intermodulation caused by the switching spread between single devices. Using SYNC_OUT, the modulation scheme remains the same and audio reproduction is not affected by changing the switching frequency.

Filterless Modulation/Common-Mode Idle

The MAX9773 uses Maxim's unique modulation scheme that eliminates the LC filter required by traditional Class D amplifiers, improving efficiency, reducing component count, conserving board space and system cost. Conventional Class D amplifiers output a 50% duty cycle, 180° out-of-phase square wave when no signal is present. With no filter, the square wave appears across the load as a DC voltage, resulting in finite load current, which increases power consumption especially when idling. When no signal is present at the input of the MAX9773, the amplifiers output an in-phase square wave as shown in Figure 4. Because the MAX9773 drives the speaker differentially, the two outputs cancel each other, resulting in no net idle mode voltage across the speaker, minimizing power consumption.

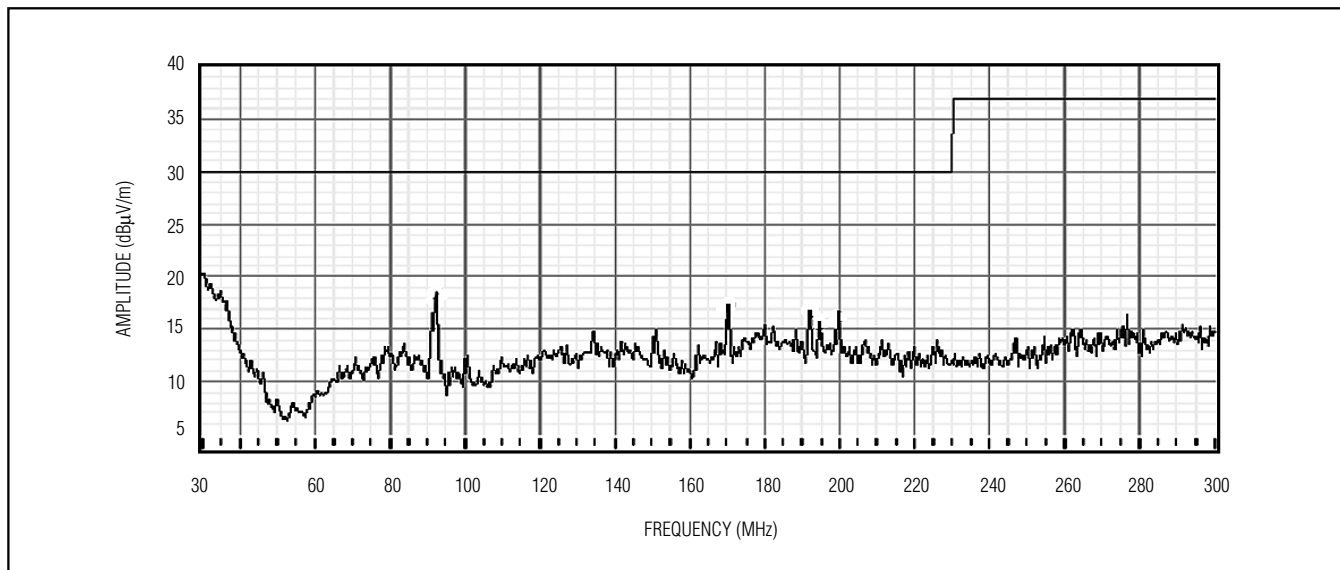

Figure 3. EMI Spectrum of MAX9773 with 6in of Twisted-Pair Speaker Cable with TDK Ferrite Beads MPZ1608S300A

1.8W, Filterless, Ultra-Low EMI, Stereo Class D Audio Power Amplifier

MAX9773

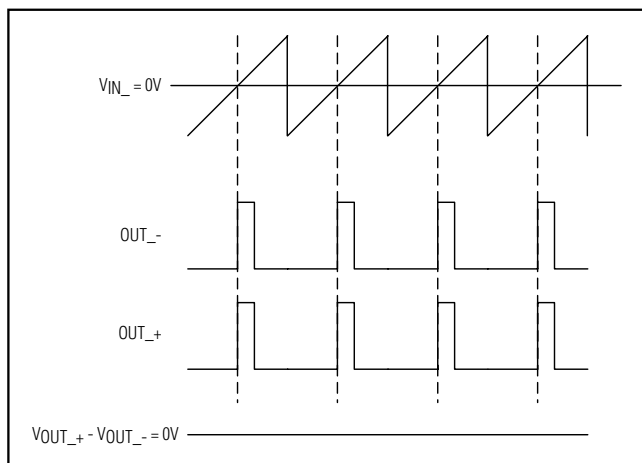

Figure 4. MAX9773 Outputs with No Input Signal

Efficiency

Efficiency of a Class D amplifier is due to the switching operation of the output stage transistors. In a Class D amplifier, the output transistors act as current-steering switches and consume negligible additional power. Any power loss associated with the Class D output stage is mostly due to the I^2R loss of the MOSFET on-resistance, and quiescent-current overhead.

The theoretical best efficiency of a linear amplifier is 78%; however, that efficiency is only exhibited at peak output powers. Under normal operating levels (typical music reproduction levels), efficiency falls below 30%, whereas the MAX9773 still exhibits >80% efficiencies under the same conditions (Figure 5).

Shutdown

The MAX9773 has a shutdown mode that reduces power consumption and extends battery life. Driving $\overline{\text{SHDN}}$ low places the MAX9773 in a low-power (0.1 μA) shutdown mode. Connect $\overline{\text{SHDN}}$ to V_{DD} for normal operation.

Click-and-Pop Suppression

The MAX9773 features comprehensive click-and-pop suppression that eliminates audible transients on startup and shutdown. While in shutdown, the H-bridge is in a high-impedance state. During startup, or power-up, the input amplifiers are muted and an internal loop sets the modulator bias voltages to the correct levels, preventing clicks and pops when the H-bridge is subsequently enabled. For 80ms following startup, a soft-start function gradually unmutes the input amplifiers.

Applications Information

Filterless Operation

Traditional Class D amplifiers require an output filter to recover the audio signal from the amplifier's PWM output.

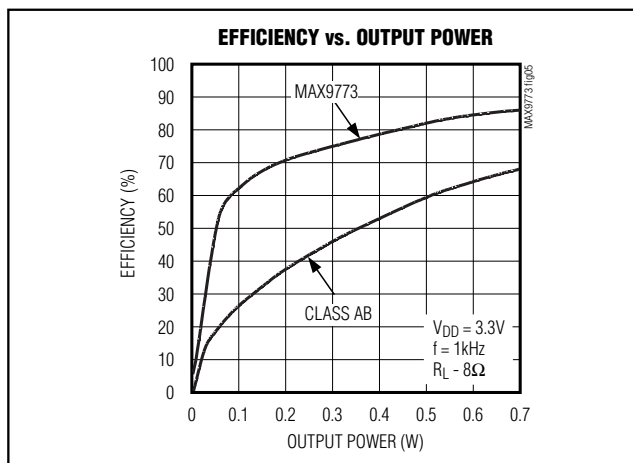

Figure 5. MAX9773 Efficiency vs. Class AB Efficiency

The filters add cost, increase the solution size of the amplifier, and can decrease efficiency. The traditional PWM scheme uses large differential output swings ($2 \times V_{\text{DD(P-P)}}$) and causes large ripple currents. Any parasitic resistance in the filter components results in a loss of power, lowering the efficiency.

The MAX9773 does not require an output filter. The device relies on the inherent inductance of the speaker coil and the natural filtering of both the speaker and the human ear to recover the audio component of the square-wave output. Eliminating the output filter results in a smaller, less costly, more efficient solution.

Because the frequency of the MAX9773 output is well beyond the bandwidth of most speakers, voice coil movement due to the square-wave frequency is very small. Although this movement is small, a speaker not designed to handle the additional power can be damaged. For optimum results, use a speaker with a series inductance $>10\mu\text{H}$. Typical 8Ω speakers, for portable audio applications, exhibit series inductances in the range of $20\mu\text{H}$ to $100\mu\text{H}$.

Output Offset

Unlike a Class AB amplifier, the output offset voltage of a Class D amplifier does not noticeably increase quiescent current draw when a load is applied. This is due to the power conversion of the Class D amplifier. For example, an 8mV DC offset across an 8Ω load results in 1mA extra current consumption in a Class AB device. In the Class D case, an 8mV offset into 8Ω equates to an additional power drain of $8\mu\text{W}$. Due to the high efficiency of the Class D amplifier, this represents an additional quiescent current draw of: $8\mu\text{W}/(V_{\text{DD}} / 100 \times \eta)$, which is on the order of a few μA .

1.8W, Filterless, Ultra-Low EMI, Stereo Class D Audio Power Amplifier

**Table 2. Gain Settings (V_{DD} = 3.3V,
THD+N = 10%)**

GAIN1	GAIN2	GAIN (dB)	INPUT (V _{RMS})	R _L (Ω)	P _{OUT} (mW)
0	0	+26	0.097699	4	950
1	0	+20	0.194936	4	950
0	1	+15.6	0.323513	4	950
1	1	12	0.489657	4	950
0	0	+26	0.114288	8	650
1	0	+20	0.228035	8	650
0	1	+15.6	0.378444	8	650
1	1	12	0.572798	8	650

Selectable Gain

The MAX9773 features four selectable gain settings, minimizing external component count. Gains of 12dB, 15.6dB, 20dB, and 26dB are set through gain-select inputs, GAIN1 and GAIN2. GAIN1 and GAIN2 can be hardwired or digitally controlled. Table 2 shows the suggested gain settings to attain a maximum output power from a given peak input voltage and given load at V_{DD} = 3.3V and THD+N = 10%.

Custom Gain Settings

The MAX9773 can be set up with any gain setting by adding three external resistors per amplifier. Figure 6 shows the required circuit for setting up custom gain. Table 3 displays a list of the components to use for several gain settings.

Table 3. Custom Gain Components

GAIN_SETTINGS		GAIN (dB)	R1 (Ω)	R2 (Ω)	C _{IN} (μF)	GAIN TOLERANCE (dB)
GAIN1	GAIN2					
0	0	26	—	—	1	—
0	0	25	750	20k	1	+0.12/-0.07
0	0	24	1k	10k	1.5	+0.14/-0.08
0	0	23	1k	6k	2.2	+0.13/-0.08
0	0	22	1.5k	6k	2.2	+0.16/-0.1
0	0	21	2k	6k	2	+0.19/-0.12
1	0	20	—	—	1	—
1	0	19	1.2k	30k	1	+0.1/-0.06
1	0	18	2k	20k	1	+0.15/-0.09
1	0	17	2k	10k	1.2	+0.12/-0.07
1	0	16	2.5k	10k	1.2	+0.15/-0.09
0	1	15	1k	40k	0.86	+0.06/-0.03
0	1	14	2.8k	40k	0.68	+0.15/-0.09
0	1	13	2.8k	20k	0.86	+0.14/-0.08
1	1	12	—	—	1	—
1	1	11	1.8k	40k	0.86	+0.08/-0.05
1	1	10	4k	40k	0.68	+0.15/-0.09
1	1	9	5k	30k	0.68	+0.17/-0.1
1	1	8	5k	20k	0.68	+0.15/-0.09
1	1	7	5.5k	16k	0.68	+0.15/-0.09
1	1	6	7k	16k	0.68	+0.17/-0.1
1	1	5	8k	14k	0.68	+0.17/-0.1
1	1	4	8k	12k	0.68	+0.16/-0.1
1	1	3	10k	12k	0.68	+0.17/-0.1
1	1	2	11k	10k	0.68	+0.16/-0.1
1	1	1	12k	10k	0.58	+0.16/-0.1
1	1	0	14k	10k	0.47	+0.17/-0.1

1.8W, Filterless, Ultra-Low EMI, Stereo Class D Audio Power Amplifier

MAX9773

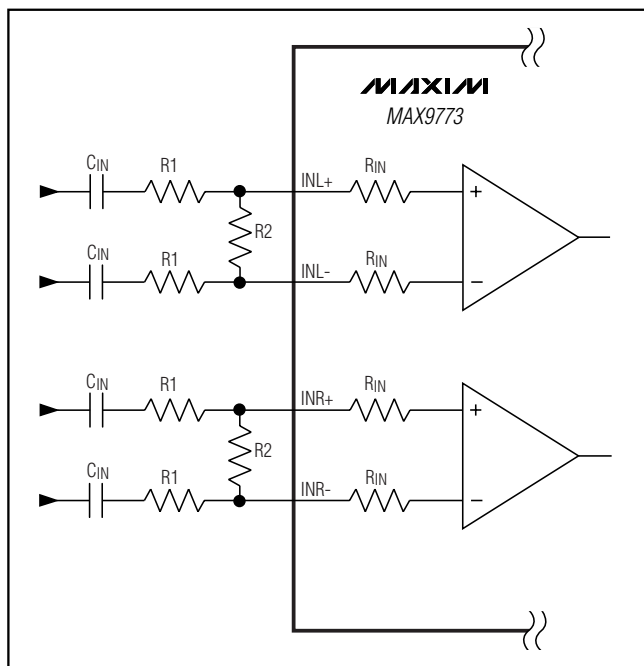

Figure 6. Custom Gain Setting

The internal input resistance, R_{IN} , changes with each gain setting. The $R1$ resistors attenuate the gain and resistors $R2$ compensate for R_{IN} 's tolerance, which can be as high as 25%. C_{IN} must be adjusted to compensate for the total change in input impedance or the low-frequency roll-off point shifts.

Input Amplifier Differential Input

The MAX9773 features a differential input structure, making it compatible with many CODECs and offers improved noise immunity over a single-ended input amplifier. In devices such as cellular phones, high-frequency signals from the RF transmitter can be picked up by the amplifier's input traces. The signals appear at the amplifier's inputs as common-mode noise. A differential input amplifier amplifies the difference of the two inputs, any signal common to both inputs is canceled.

Single-Ended Input

The MAX9773 can be configured as a single-ended input amplifier by capacitively coupling either input to GND, and driving the other input (Figure 7).

Component Selection Input Filter

An input capacitor, C_{IN} , in conjunction with the MAX9773 input impedance (R_{IN}) forms a highpass filter that removes the DC bias from an incoming signal. The

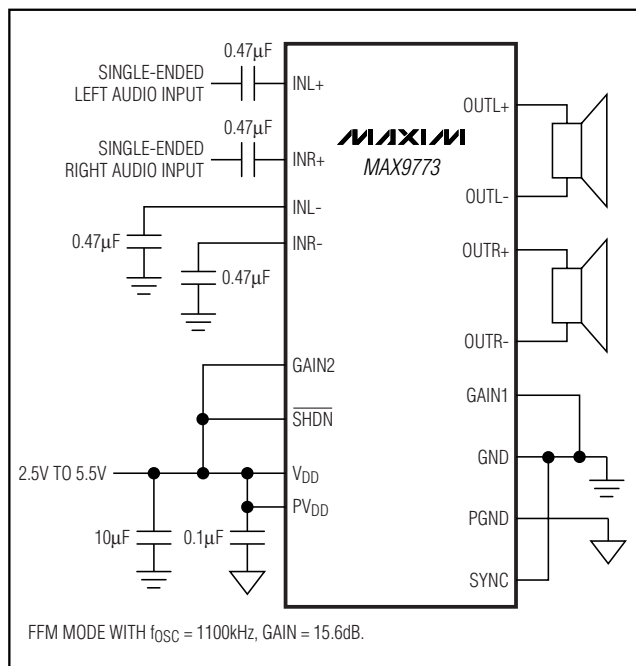

Figure 7. Single-Ended Input

AC-coupling capacitor allows the amplifier to automatically bias the signal to an optimum DC level. Assuming zero-source impedance, the -3dB point of the highpass filter is given by:

$$f_{-3dB} = \frac{1}{2\pi R_{IN} C_{IN}}$$

Choose C_{IN} so f_{-3dB} is well below the lowest frequency of interest. Use capacitors whose dielectrics have low-voltage coefficients, such as tantalum or aluminum electrolytic. Capacitors with high-voltage coefficients, such as ceramics, may result in increased distortion at low frequencies.

Other considerations when designing the input filter include the constraints of the overall system and the actual frequency band of interest. Although high-fidelity audio calls for a flat-gain response between 20Hz and 20kHz, portable voice-reproduction devices such as cellular phones and two-way radios need only concentrate on the frequency range of the spoken human voice (typically 300Hz to 3.5kHz). In addition, speakers used in portable devices typically have a poor response below 300Hz. Taking these two factors into consideration, the input filter may not need to be designed for a 20Hz to 20kHz response, saving both board space and cost due to the use of smaller capacitors.

1.8W, Filterless, Ultra-Low EMI, Stereo Class D Audio Power Amplifier

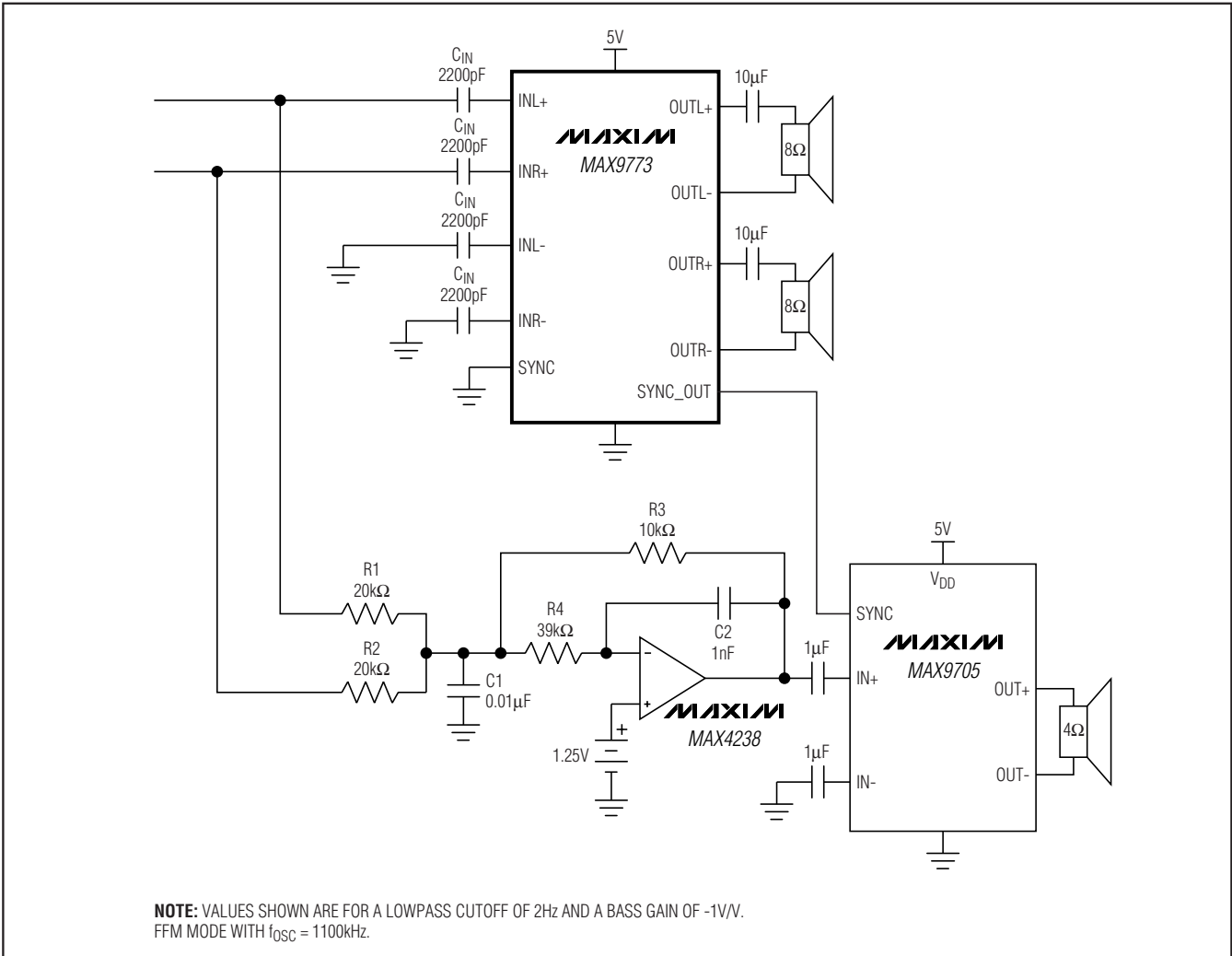

Figure 8. 2.1 Channel Application Circuit

Output Filter

The MAX9773 does not require an output filter. The device passes FCC emissions standards with 6in of unshielded speaker cables. However, output filtering can be used if a design is failing radiated emissions due to board layout or cable length, or if the circuit is near EMI-sensitive devices. Use a ferrite bead filter when radiated frequencies above 10MHz are of concern. Use an LC filter or a common-mode choke when radiated emissions below 10MHz are of concern, or when long leads (>6in) connect the amplifier to the speaker.

2.1 Channel Configuration

The typical 2.1 channel application circuit (Figure 8) shows the MAX9773 configured as a mid/high-frequency amplifier and the MAX9705 configured as a mono bass amplifier. Input capacitors (C_{IN}) set the highpass cutoff frequency according to the following equation:

$$f = \frac{1}{2\pi \times R_{IN} \times C_{IN}}$$

where R_{IN} is the typical input resistance of the MAX9773. The 10μF capacitors on the output of the MAX9773 ensure a two-pole highpass filter.

1.8W, Filterless, Ultra-Low EMI, Stereo Class D Audio Power Amplifier

MAX9773

Low frequencies are summed through a two-pole low-pass filter and sent to the MAX9705 mono speaker amplifier. The passband gain of the lowpass filter is unity for in-phase stereo signals:

$$A_{VLP} = \frac{-2 \times R3}{R1}$$

where $R1 = R2$ and $R3 = R1/R2$. The cutoff frequency of the lowpass filter is set by the following equation:

$$f_{LP} = \frac{1}{2\pi} \times \sqrt{\frac{1}{C1 \times C2 \times R3 \times R4}}$$

Supply Bypassing, Layout, and Grounding

Proper layout and grounding are essential for optimum performance. Use large traces for the power-supply inputs and amplifier outputs to minimize losses due to parasitic trace resistance. Large traces also aid in moving heat away from the package. Proper grounding improves audio performance, minimizes crosstalk between channels, and prevents any switching noise from coupling into the audio signal. Connect PGND and GND together at a single point on the PC board. Route all traces that carry switching transients away from GND and the traces/components in the audio signal path.

Bypass V_{DD} with a 0.1 μ F capacitor to GND and PV_{DD} with a 10 μ F capacitor to PGND. Place the bypass capacitors as close to the MAX9773 as possible. Use large, low-resistance output traces. Current drawn from the outputs increases as load impedance decreases. High-output trace resistance decreases the power delivered to the load. Large output, supply, and GND traces allow more heat to move from the MAX9773 to the air, decreasing the thermal impedance of the circuit.

The MAX9773 thin QFN-EP package features an exposed thermal pad on its underside. This pad lowers the package's thermal impedance by providing a direct heat conduction path from the die to the PC board. Connect the exposed thermal pad to the GND plane.

UCSP Applications Information

For the latest application details on UCSP construction, dimensions, tape carrier information, printed circuit board techniques, bump-pad layout, and recommended reflow temperature profile, as well as the latest information on reliability testing results, refer to Application Note: *UCSP—A Wafer-Level Chip-Scale Package* available on Maxim's website at www.maxim-ic.com/ucsp.

1.8W, Filterless, Ultra-Low EMI, Stereo Class D Audio Power Amplifier

System Diagram

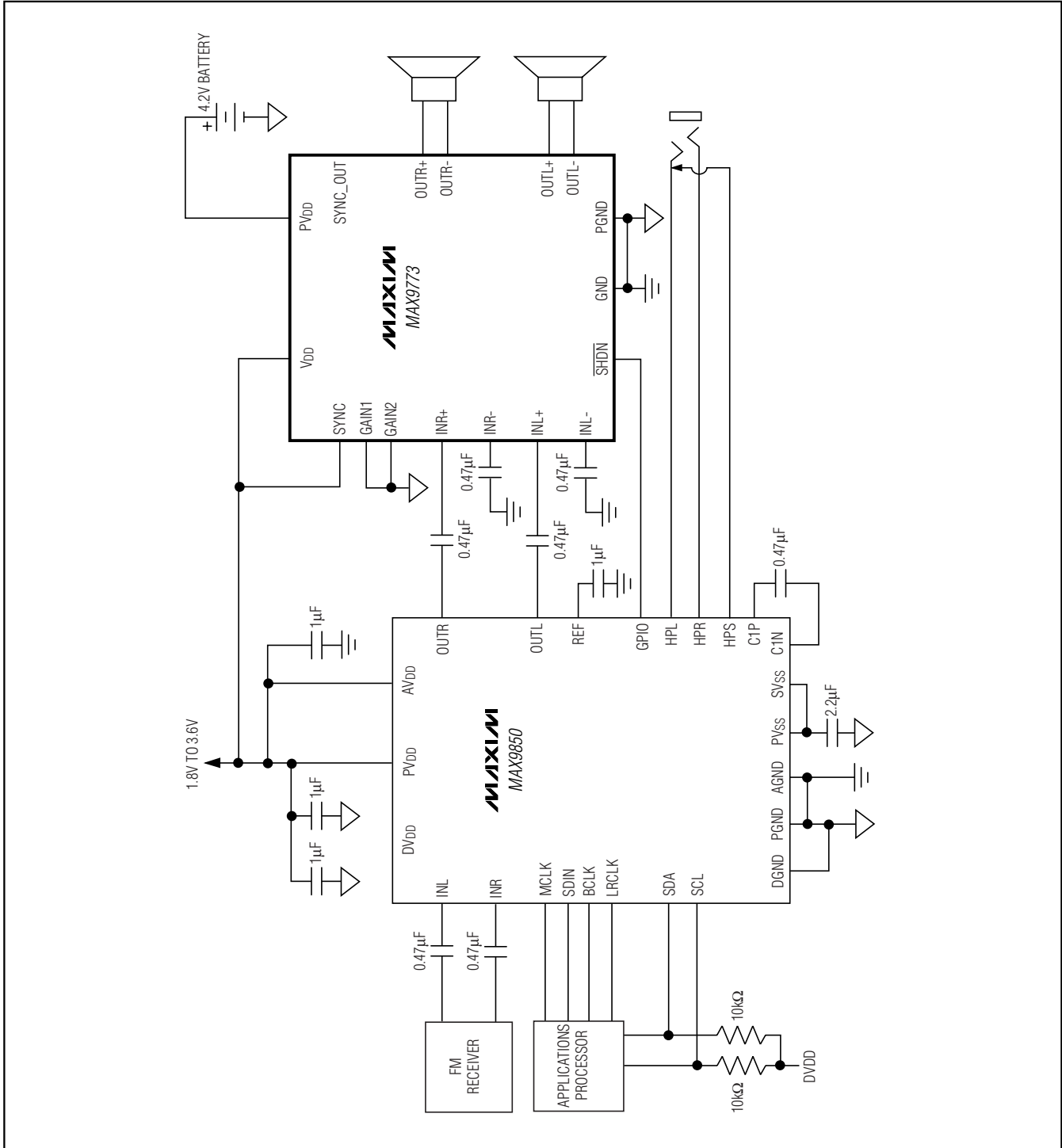

1.8W, Filterless, Ultra-Low EMI, Stereo Class D Audio Power Amplifier

Pin Configurations

MAX9773

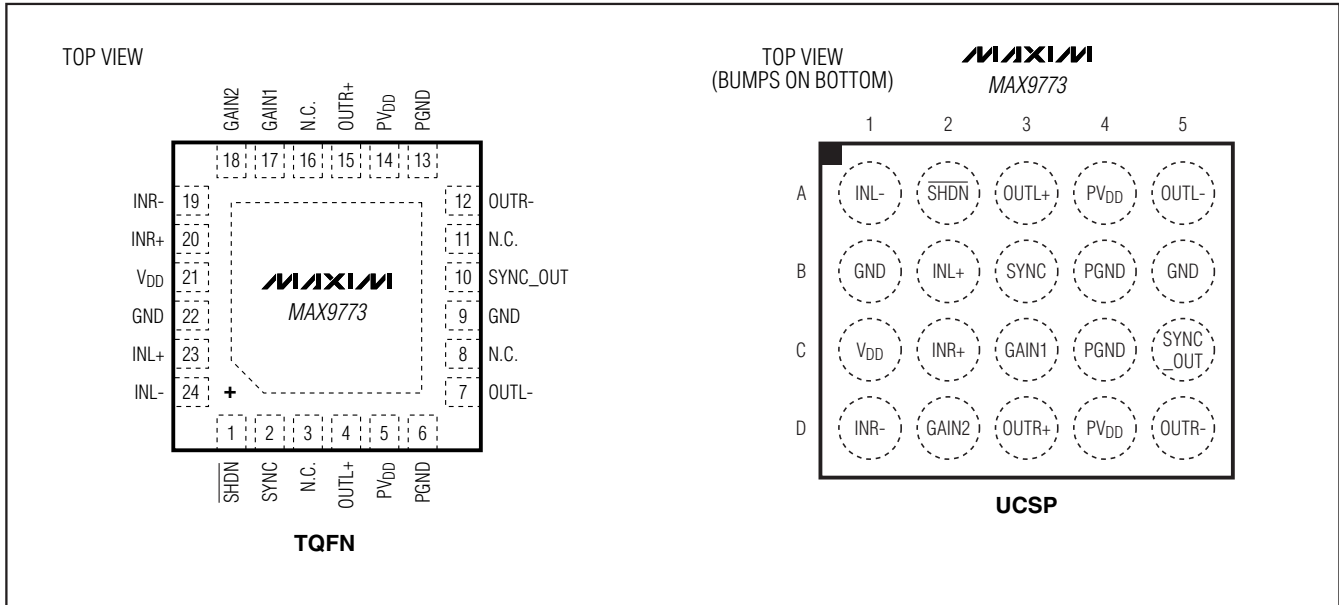

Gain Selection

GAIN SELECTION	GAIN (dB)
GAIN1 = 0, GAIN2 = 0	26
GAIN1 = 1, GAIN2 = 0	20
GAIN1 = 0, GAIN2 = 1	15.6
GAIN1 = 1, GAIN2 = 1	12

Chip Information

PROCESS: BiCMOS

1.8W, Filterless, Ultra-Low EMI, Stereo Class D Audio Power Amplifier

Package Information (continued)

(The package drawing(s) in this data sheet may not reflect the most current specifications. For the latest package outline information, go to www.maxim-ic.com/packages.)

MAX9773

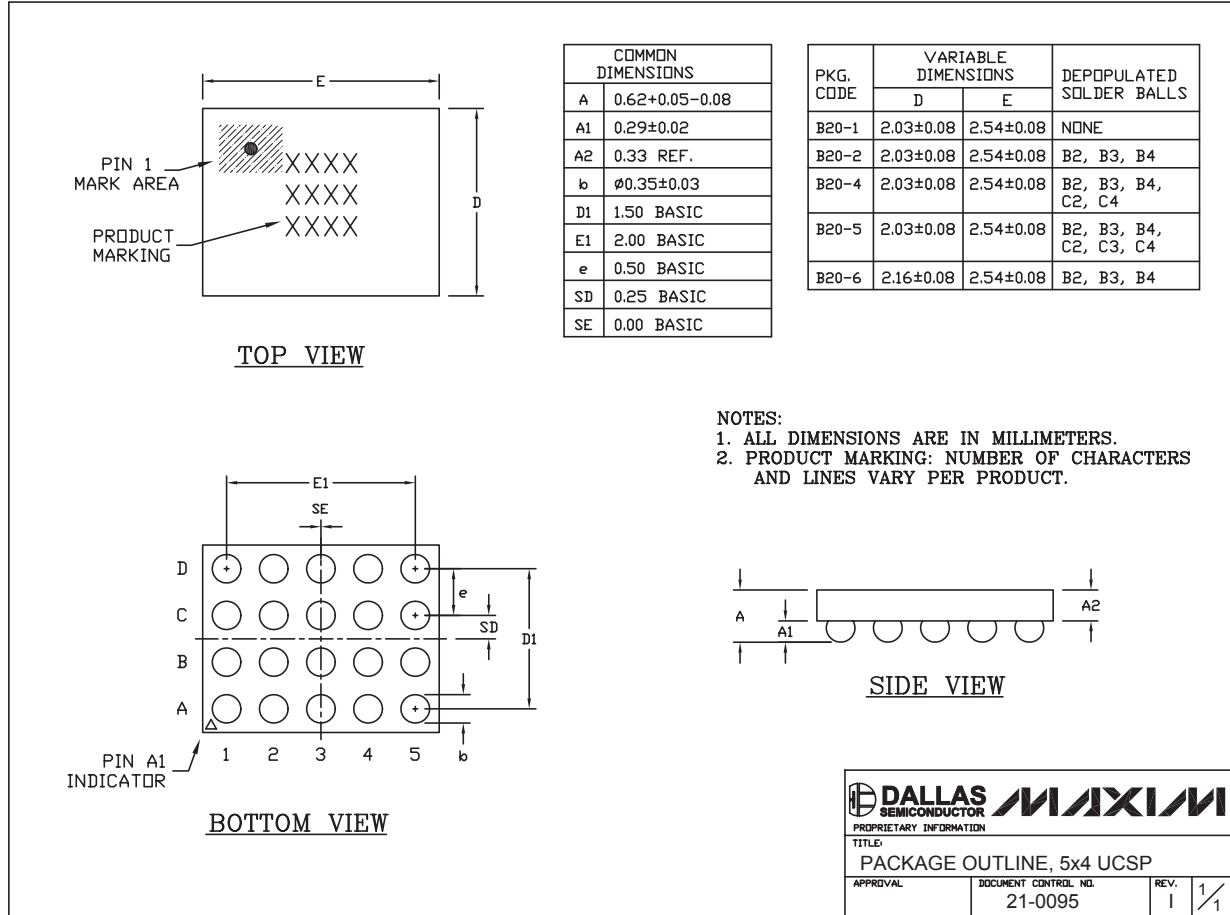

5x4 UCSP:EPS

MAX9773 Package Code: B20-1

DALLAS SEMICONDUCTOR **MAXIM**
 PROPRIETARY INFORMATION

TITLE:
PACKAGE OUTLINE, 5x4 UCSP

APPROVAL	DOCUMENT CONTROL NO. 21-0095	REV. I	1/1
----------	---------------------------------	-----------	-----

Maxim cannot assume responsibility for use of any circuitry other than circuitry entirely embodied in a Maxim product. No circuit patent licenses are implied. Maxim reserves the right to change the circuitry and specifications without notice at any time.

Maxim Integrated Products, 120 San Gabriel Drive, Sunnyvale, CA 94086 408-737-7600 _____ **21**

Looking for pricing, stock, or lifecycle information?

Click below to explore more details on WIN SOURCE:

 [View MAX9773ETG+ on WIN SOURCE](#)

 [Maxim Integrated Information](#)

Optimize Your Supply Chain with WIN SOURCE Solutions

-  Global Sourcing Solution
-  Obsolete Management
-  Cost Control Management
-  Shortage Management
-  Alternative Solution
-  Excess Inventory Management