



**THE DATASHEET OF
MAX9715ETE+T**



EVALUATION KIT
AVAILABLE

MAXIM

2.8W, Low-EMI, Stereo, Filterless Class D Audio Amplifier

MAX9715

General Description

The MAX9715 high-efficiency, stereo, Class D audio power amplifier provides up to 2.8W per channel into a 4Ω speaker with a 5V supply. Maxim's second-generation Class D technology features robust output protection, high efficiency, and high power-supply rejection (PSRR) while eliminating the need for output filters. Selectable gain settings, +10.5dB or +9.0dB, adjust the amplifier gain to suit the audio input level and speaker load.

The MAX9715 features high PSRR (71dB at 1kHz), allowing for operation from noisy supplies without additional regulation. Comprehensive click-and-pop suppression eliminates audible clicks and pops at startup and shutdown. The MAX9715 operates from a single 5V supply and consumes only 12mA of supply current. Integrated shutdown control reduces supply current to less than 100nA.

The MAX9715 is fully specified over the extended -40°C to $+85^{\circ}\text{C}$ temperature range and is available in a thermally enhanced 16-pin QFN-EP package.

Applications

High-End Notebook Audio
LCD Projectors
Portable Audio
Multimedia Docking Stations

Typical Operating Circuit/Functional Diagram appears at end of data sheet.

Block Diagram

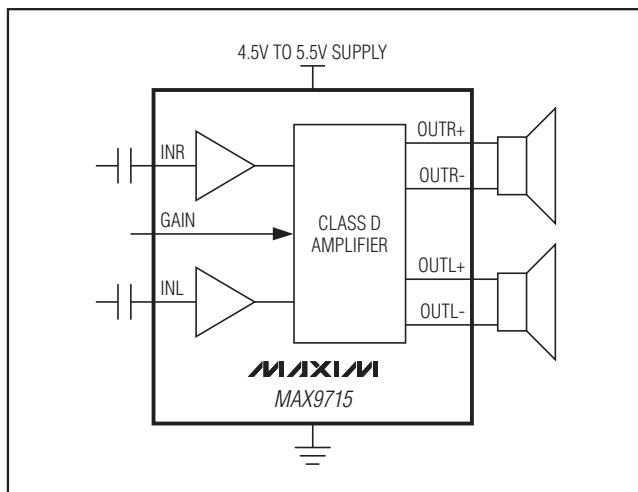

Features

- ◆ 5V Single-Supply Operation
- ◆ Spread-Spectrum Modulator Reduces EMI
- ◆ 2.8W, Class D, Stereo Speaker Amplifier (4Ω)
- ◆ Filterless Class D Requires No LC Output Filter
- ◆ High PSRR (71dB at 1kHz)
- ◆ 86% Efficiency ($R_L = 8\Omega$, $P_{OUT} = 1W$)
- ◆ Low-Power Shutdown Mode
- ◆ Integrated Click-and-Pop Suppression
- ◆ Low Total Harmonic Distortion: 0.06% at 1kHz
- ◆ Short-Circuit and Thermal Protection
- ◆ Internal Gain, +9.0dB or +10.5dB
- ◆ Available in Space-Saving Package
16-Pin Thin QFN-EP (5mm x 5mm x 0.8mm)

Ordering Information

PART	TEMP RANGE	PIN-PACKAGE
MAX9715ETE+	-40°C to $+85^{\circ}\text{C}$	16 TQFN-EP*

+Denotes a lead-free/RoHS-compliant package.
*EP = Exposed pad.

Pin Configurations

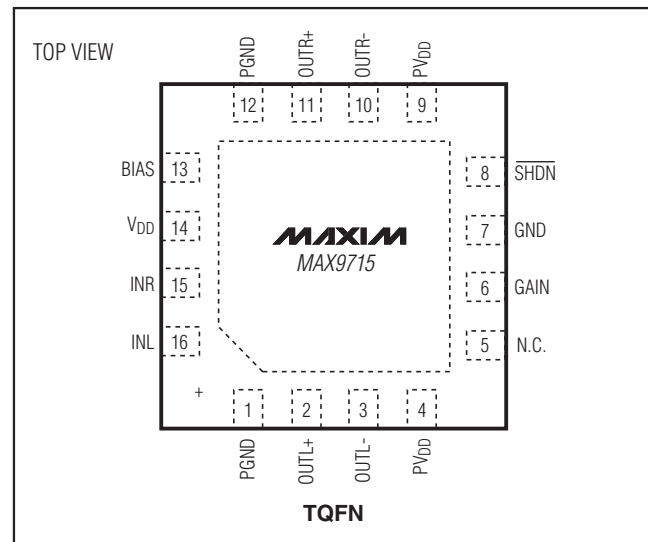

MAXIM

Maxim Integrated Products 1

For pricing, delivery, and ordering information, please contact Maxim Direct at 1-888-629-4642, or visit Maxim's website at www.maxim-ic.com.

2.8W, Low-EMI, Stereo, Filterless Class D Audio Amplifier

ABSOLUTE MAXIMUM RATINGS

V_{DD}, PV_{DD}, to GND+6V
 GND to PGND-0.3V to +0.3V
 Any Other Pin to PGND -0.3V to (V_{DD} + 0.3V)
 Duration of OUT_ Short Circuit to PGND or PV_{DD}.....Continuous
 Duration of OUT_+ Short Circuit between OUT_-Continuous
 Continuous Current Into/Out of (PV_{DD}, OUT_-, PGND).....1.7A
 Continuous Input Current (All Other Pins) ±20mA

Continuous Power Dissipation (T_A = +70°C)
 16-Pin TQFN-EP (derate 20.8mW/°C above +70°C)..1666mW
 Operating Temperature Range-40°C to +85°C
 Storage Temperature Range-65°C to +150°C
 Junction Temperature+150°C
 Lead Temperature (soldering, 10s)+300°C

Stresses beyond those listed under "Absolute Maximum Ratings" may cause permanent damage to the device. These are stress ratings only, and functional operation of the device at these or any other conditions beyond those indicated in the operational sections of the specifications is not implied. Exposure to absolute maximum rating conditions for extended periods may affect device reliability.

ELECTRICAL CHARACTERISTICS

(V_{DD} = PV_{DD} = 5.0V, GND = PGND = 0V, V_{SHDN} = V_{DD}, C_{BIAS} = 1μF, speaker impedance = 8Ω in series with 68μH connected between OUT_+ and OUT_-, GAIN = +10.5dB, T_A = T_{MIN} to T_{MAX}, unless otherwise noted. Typical values are at T_A = +25°C.) (Notes 1, 2)

PARAMETER	SYMBOL	CONDITIONS		MIN	TYP	MAX	UNITS
GENERAL							
Supply Voltage Range	V _{DD}	Inferred from PSRR test		4.5		5.5	V
Quiescent Current	I _{DD}	No load			12.8	16	mA
Shutdown Supply Current	I _{SHDN}	V _{SHDN} = 0V			0.1	2	μA
Input Resistance	R _{IN}			6.5	10	13.5	kΩ
Turn-On Time	t _{ON}				25		ms
BIAS Voltage	V _{BIAS}				1.8		V
CLASS D SPEAKER AMPLIFIERS							
Output Offset Voltage	V _{OS}	T _A = +25°C			12.6	45	mV
		T _A = T _{MIN} to T _{MAX}				70	
Maximum Speaker Amplifier Gain (Note 3)	A _v	GAIN = 0			10.5		dB
		GAIN = 1			9.0		
Power-Supply Rejection Ratio	PSRR	V _{IN-} = 0V	PV _{DD} or V _{DD} = 4.5V to 5.5V	52.4	75		dB
			f = 1kHz, 100mV _{p-p}		71		
			f = 20kHz, 100mV _{p-p}		60		
Output Power	P _{OUT}	THD+N = 1%	R _L = 8Ω		1.4		W
			R _L = 4Ω		2.3		
		THD+N = 10%	R _L = 8Ω		1.7		
			R _L = 4Ω		2.8		
Total Harmonic Distortion Plus Noise	THD+N	f = 1kHz	R _L = 8Ω, P _{OUT} = 1.2W		0.06		%
			R _L = 4Ω, P _{OUT} = 2W		0.07		
Signal-to-Noise Ratio	SNR	P _{OUT} = 1W, BW = 22Hz to 22kHz			89		dB
		P _{OUT} = 1W, A-weighted			93		
Maximum Capacitive Load	C _{L_MAX}				200		pF
Switching Frequency	f _{sw}	Average frequency in spread-spectrum operation		1.00	1.22	1.40	MHz

2.8W, Low-EMI, Stereo, Filterless Class D Audio Amplifier

ELECTRICAL CHARACTERISTICS (continued)

($V_{DD} = PV_{DD} = 5.0V$, $GND = PGND = 0V$, $V_{SHDN} = V_{DD}$, $C_{BIAS} = 1\mu F$, speaker impedance = 8Ω in series with $68\mu H$ connected between OUT_{+} and OUT_{-} , $GAIN = +10.5dB$, $T_A = T_{MIN}$ to T_{MAX} , unless otherwise noted. Typical values are at $T_A = +25^{\circ}C$.) (Notes 1, 2)

PARAMETER	SYMBOL	CONDITIONS		MIN	TYP	MAX	UNITS
Spread-Spectrum Modulation					± 120		kHz
Crosstalk		Channel-to-channel, $f = 10kHz$, $P_{OUT} = 1W$, left to right or right to left			72		dB
Click-and-Pop Level	K_{CP}	Peak voltage, A-weighted, 32 samples per second (Note 4)	Into shutdown		-64		dBV
			Out of shutdown		-46		
Efficiency	η	$R_L = 8\Omega$ in series with $68\mu H$, $P_{OUT} = 1W$ per channel, $f = 1kHz$			86		%
DIGITAL INPUTS (GAIN and SHDN)							
Input High Voltage	V_{IH}			2.0			V
Input Low Voltage	V_{IL}					0.8	V
Input Leakage Current	I_{LEAK}	SHDN				± 1	μA
		GAIN				± 1.5	

Note 1: All devices are 100% production tested at $T_A = +25^{\circ}C$. All temperature limits are guaranteed by design.

Note 2: Speaker amplifier gain is defined as $A_v = (V_{OUT_{+}} - V_{OUT_{-}}) / V_{IN}$.

Note 3: Click-and-pop level testing performed with an 8Ω resistive load in series with $68\mu H$ inductive load connected across the Class D BTL outputs. Mode transitions are controlled by the SHDN pin. Inputs AC-coupled to GND.

Note 4: Testing performed with a resistive load in series with an inductor to simulate an actual speaker load. For $R_L = 4\Omega$, $L = 33\mu H$. For $R_L = 8\Omega$, $L = 68\mu H$.

Typical Operating Characteristics

($V_{DD} = 5.0V$, $C_{VDD} = 3 \times 0.1\mu F$, $C_{BIAS} = 1\mu F$, $C_{INL} = C_{INR} = 1\mu F$, $A_v = +10.5dB$, $T_A = +25^{\circ}C$, unless otherwise noted.) (See the Typical Operating Circuit/Functional Diagram)

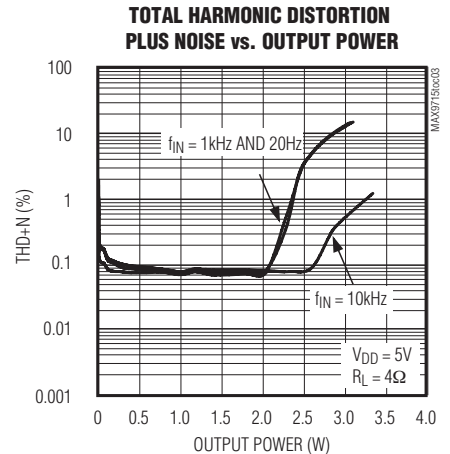
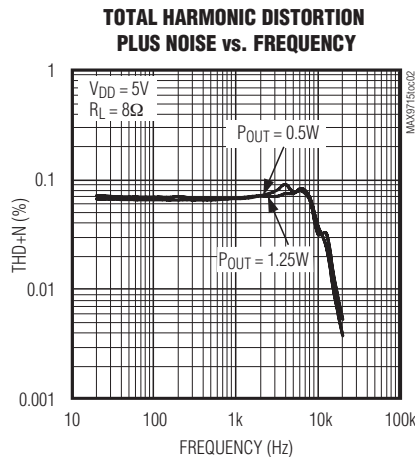
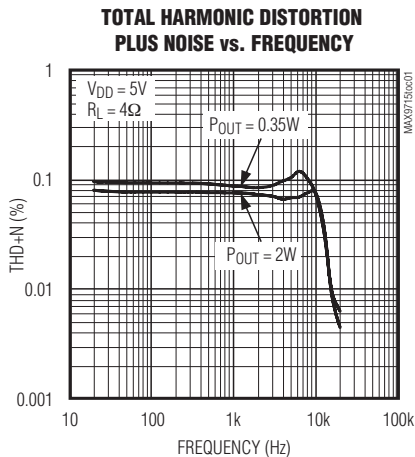

2.8W, Low-EMI, Stereo, Filterless Class D Audio Amplifier

Typical Operating Characteristics (continued)

($V_{DD} = 5.0V$, $C_{VDD} = 3 \times 0.1\mu F$, $C_{BIAS} = 1\mu F$, $C_{INL} = C_{INR} = 1\mu F$, $A_v = +10.5dB$, $T_A = +25^\circ C$, unless otherwise noted.) (See the Typical Operating Circuit/Functional Diagram)

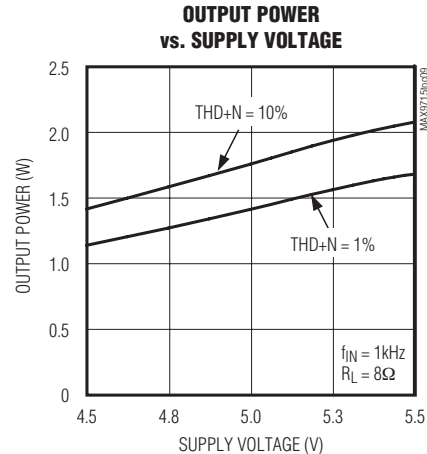
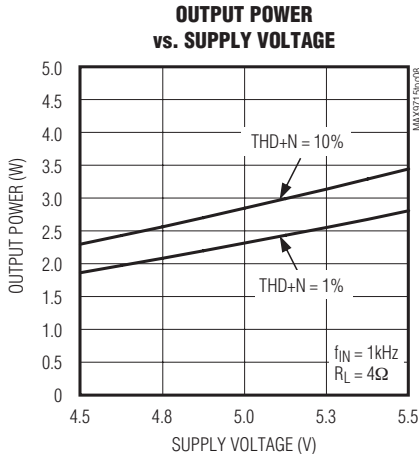
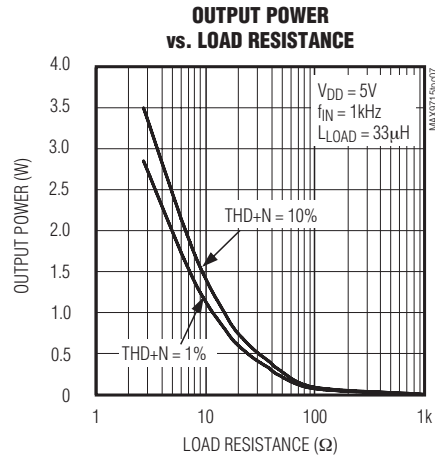
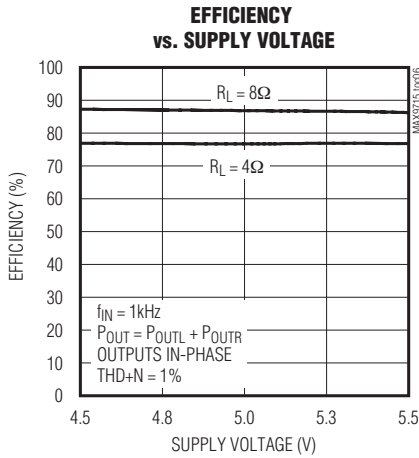
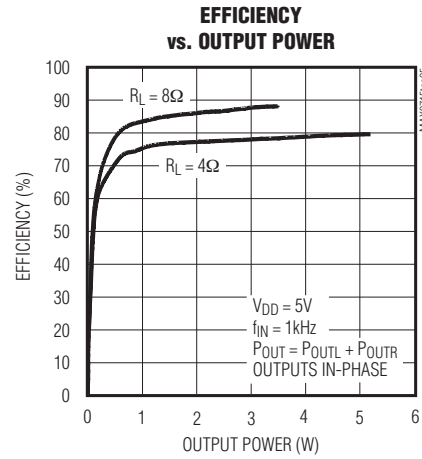
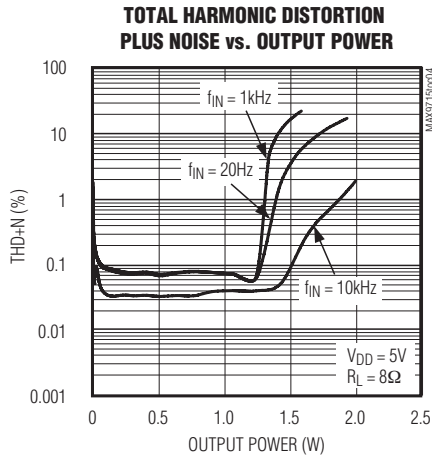

2.8W, Low-EMI, Stereo, Filterless Class D Audio Amplifier

MAX9715

Typical Operating Characteristics (continued)

($V_{DD} = 5.0V$, $C_{VDD} = 3 \times 0.1\mu F$, $C_{BIAS} = 1\mu F$, $C_{INL} = C_{INR} = 1\mu F$, $A_V = +10.5dB$, $T_A = +25^\circ C$, unless otherwise noted.) (See the Typical Operating Circuit/Functional Diagram)

POWER-SUPPLY REJECTION RATIO vs. FREQUENCY

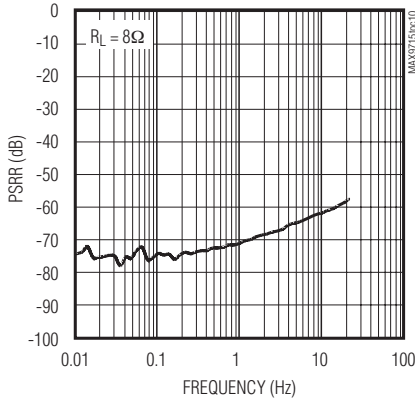

CROSSTALK vs. FREQUENCY

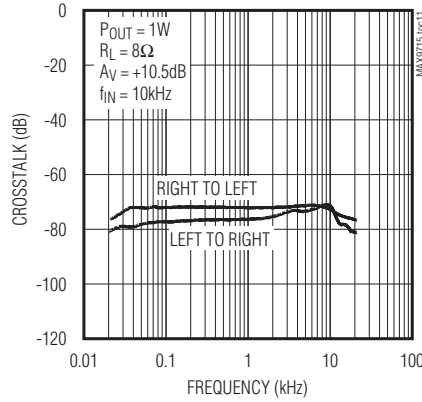

OUTPUT SPECTRUM vs. FREQUENCY

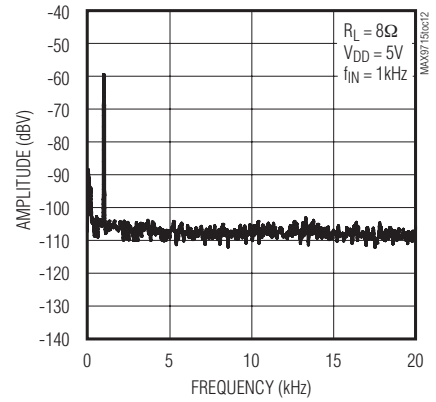

OUTPUT SPECTRUM vs. FREQUENCY (A-WEIGHTED)

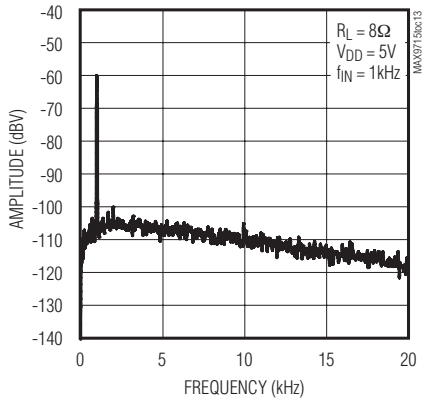

WIDEBAND SPECTRUM

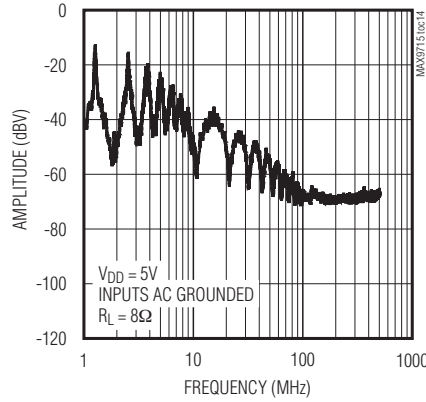

SUPPLY CURRENT vs. SUPPLY VOLTAGE

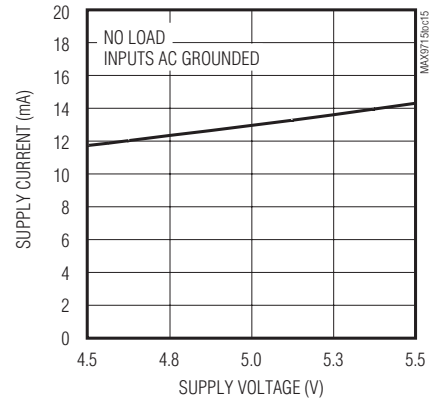

2.8W, Low-EMI, Stereo, Filterless Class D Audio Amplifier

Typical Operating Characteristics (continued)

($V_{DD} = 5.0V$, $C_{VDD} = 3 \times 0.1\mu F$, $C_{BIAS} = 1\mu F$, $C_{INL} = C_{INR} = 1\mu F$, $A_v = +10.5dB$, $T_A = +25^\circ C$, unless otherwise noted.) (See the Typical Operating Circuit/Functional Diagram)

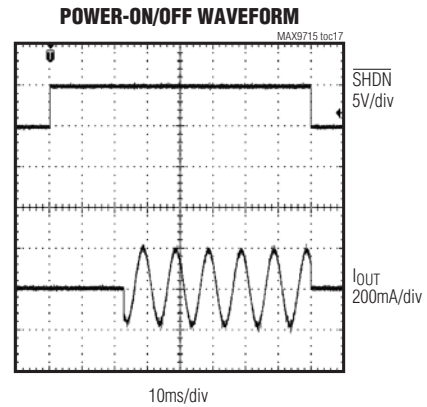
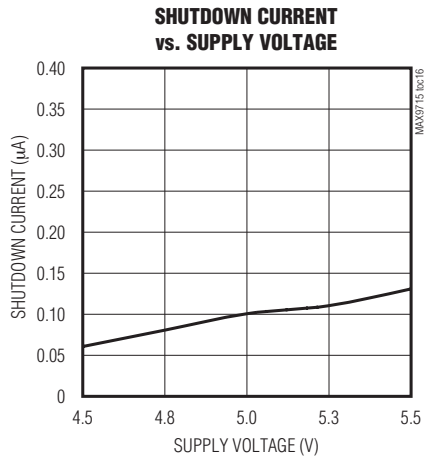

Pin Description

PIN	NAME	FUNCTION
1, 12	PGND	Power Ground
2	OUTL+	Left-Channel Positive Speaker Output
3	OUTL-	Left-Channel Negative Speaker Output
4, 9	PVDD	Positive Speaker Power-Supply Input. Power-supply input for speaker amplifier output stages. Connect to V_{DD} and bypass with $0.1\mu F$ to PGND.
5	N.C.	No connection. Not internally connected.
6	GAIN	Gain Select. Sets the internal amplifier gain. See the <i>Gain Selection</i> section.
7	GND	Ground
8	\overline{SHDN}	Shutdown Control. Drive \overline{SHDN} low to shut down the MAX9715.
10	OUTR-	Right-Channel Negative Speaker Output
11	OUTR+	Right-Channel Positive Speaker Output
13	BIAS	Bias Voltage Output. $V_{BIAS} = 1.8V$, bypass BIAS to GND with a $1\mu F$ ceramic capacitor.
14	V_{DD}	Positive Power-Supply Input. Bypass to GND with a $0.1\mu F$ ceramic capacitor.
15	INR	Right-Channel Input
16	INL	Left-Channel Input
—	EP	Exposed Paddle. Connect EP to an electrically isolated copper pad or GND.

2.8W, Low-EMI, Stereo, Filterless Class D Audio Amplifier

MAX9715

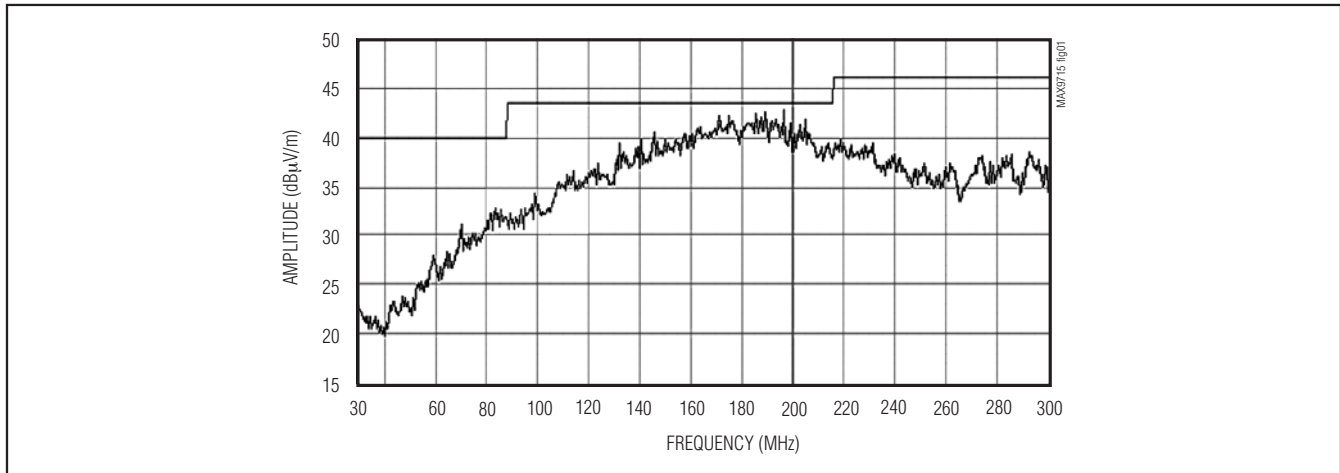

Figure 1. MAX9715 Radiated Emissions with 75mm of Speaker Cable

Detailed Description

The MAX9715 2.8W, Class D speaker amplifier with gain control offers Class AB performance with Class D efficiency while occupying minimal board space. A unique modulation scheme and spread-spectrum switching allow filterless operation to create a compact, flexible, low-noise, efficient audio power amplifier. The MAX9715 features high 71dB at 1kHz PSRR, low 0.06% THD+N, industry-leading click-and-pop performance and a low-power shutdown mode.

The MAX9715 features an undervoltage lockout that prevents operation from an insufficient power supply and click-and-pop suppression that eliminates audible transients at startup and shutdown. The speaker amplifier includes thermal-overload and short-circuit protection.

The MAX9715 features unique, spread-spectrum operation that reduces the amplitude of spectral components at high frequencies, reducing EMI emissions that might otherwise be radiated by the speaker and cables. The switching frequency varies randomly by $\pm 120\text{kHz}$ around the center frequency (1.22MHz). The modulation scheme is consistent with Maxim's Class D amplifiers but the period of the triangle waveform changes from cycle to cycle. Audio reproduction is not affected by the spread-spectrum switching scheme. Instead of a large amount of spectral energy present at multiples of the switching frequency that energy is now spread over a range of frequencies. The spreading is increased with frequency so that above a few megahertz, the wideband spectrum looks like white noise for EMI purposes (Figure 1).

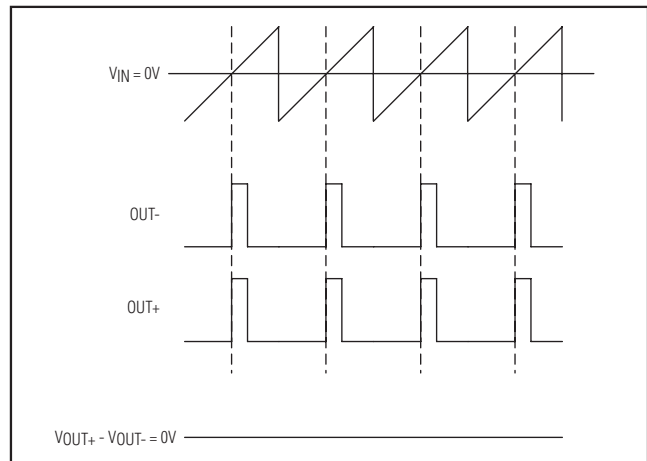

Figure 2. MAX9715 Output without Input Signal Applied

Filterless Modulation/Common-Mode Idle

The spread-spectrum modulation scheme eliminates the LC filter required by traditional Class D amplifiers, improving efficiency, reducing component count, conserving board space and system cost. Conventional Class D amplifiers output a 50% duty cycle square wave when no signal is present. With no filter, the output square wave appears across the load, resulting in finite load current, which increases power consumption. When no signal is present at the input, the MAX9715 outputs switch as shown in Figure 2. The two outputs cancel each other because the MAX9715 drives the speaker differently, minimizing power consumption as there is no net idle-mode voltage across the speaker.

2.8W, Low-EMI, Stereo, Filterless Class D Audio Amplifier

Efficiency

Efficiency of a Class D amplifier is attributed to the region of operation of the output-stage transistors. In a Class D amplifier, the output transistors act as current-steering switches and consume negligible additional power. Any power loss associated with the Class D output stage is mostly due to the I^2R loss of the MOSFET on-resistance, switching losses, and quiescent current overhead.

The theoretical best efficiency of a linear amplifier is 78%, however, that efficiency is only exhibited at peak output powers. Under normal operating levels (typical music or voice reproduction levels), efficiency falls below 30%. Under the same conditions, the MAX9715 still exhibits >80% efficiencies (Figure 3).

Gain Selection

Drive GAIN high to set the gain of the speaker amplifiers to +9dB, drive GAIN low to set the gain of the speaker amplifiers to +10.5dB (see Table 1). The gain of the MAX9715 is calculated by the following equation:

$$20 \times \log \left(\frac{V_{OUT+} - V_{OUT-}}{V_{IN}} \right)$$

Table 2 shows the speaker amplifier input voltage needed to attain maximum output power from a given gain setting and load.

Shutdown

The MAX9715 features a 0.1µA low-power shutdown mode that reduces quiescent current consumption and extends battery life. Driving SHDN low disables the output amplifiers, bias circuitry, and drives BIAS to GND. Connect SHDN to logic 1 for normal operation.

Click-and-Pop Suppression

The MAX9715 speaker amplifiers feature Maxim's comprehensive, industry-leading click-and-pop suppression that eliminates any audible transients at startup. The outputs are high-impedance while in shutdown. During startup or power-up, the modulator bias voltage is set to the correct level while the input amplifiers are muted. The input amplifiers are muted for 25ms allowing the input capacitors to charge to the bias voltage (V_{BIAS}). The amplifiers are then unmuted, ensuring click-free startup.

Applications Information

Filterless Operation

Traditional Class D amplifiers require an output filter to recover the audio signal from the amplifier's PWM output. The filters add cost, increase the solution size of the

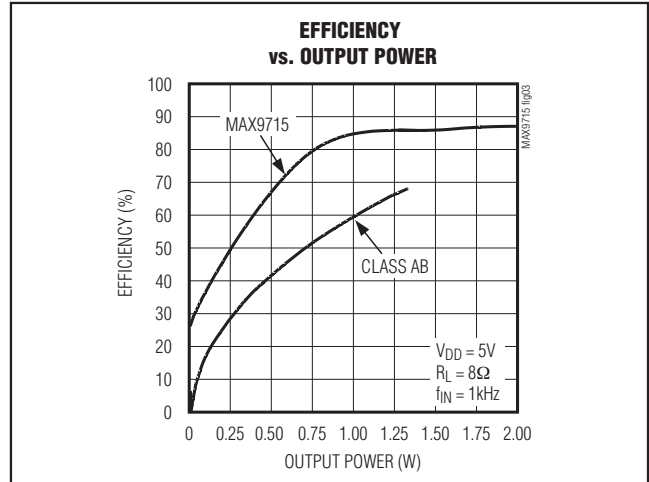

Figure 3. MAX9715 Class D Efficiency vs. Typical Class AB Efficiency

Table 1. MAX9715 Maximum Gain Settings

GAIN	SPEAKER MODE GAIN (dB)
0	+10.5
1	+9.0

Table 2. MAX9715 Input Voltage and Gain Settings for Maximum Output Power

GAIN (dB)	INPUT (V_{RMS})	R_L (Ω)	P_{OUT} (W)
10.5	0.90	4	2.3
9.0	1.08	4	2.3
10.5	1.00	8	1.4
9.0	1.19	8	1.4

amplifier, and can decrease efficiency. The traditional PWM scheme uses large differential output swings ($2 \times V_{DD(P-P)}$), which causes large ripple currents. Any parasitic resistance in the filter components results in a loss of power, lowering the efficiency.

The MAX9715 does not require an output filter. The device relies on the inherent inductance of the speaker coil and the natural filtering of both the speaker and the human ear to recover the audio component of the square-wave output. The elimination of the output filter results in a smaller, less costly, more efficient solution.

2.8W, Low-EMI, Stereo, Filterless Class D Audio Amplifier

Voice coil movement due to the square-wave frequency is very small because the switching frequency of the MAX9715 is well beyond the bandwidth of most speakers. Although this movement is small, a speaker not designed to handle the additional power may be damaged. Use a speaker with a series inductance > 30μH for optimum efficiency. Typical 8Ω speakers exhibit series inductances in the 30μH to 100μH range. The highest efficiency is achieved with speaker inductances > 60μH.

Component Selection Input Filter

The input capacitor (C_{IN}), in conjunction with the amplifier input resistance (R_{IN}), forms a highpass filter that removes the DC bias from an incoming signal (see the *Typical Application Circuit*). The AC-coupling capacitor allows the amplifier to bias the signal to an optimum DC level. Assuming zero source impedance, the -3dB point of the highpass filter is given by:

$$f_{-3dB} = \frac{1}{2\pi \times R_{IN} \times C_{IN}}$$

R_{IN} is the amplifier's internal input resistance value given in the *Electrical Characteristics* table. Choose C_{IN} so f_{-3dB} is well below the lowest frequency of interest. Setting f_{-3dB} too high affects the amplifier's low-frequency response. Use capacitors with low-voltage coefficient dielectrics, such as tantalum or aluminum electrolytic. Capacitors with high-voltage coefficients, such as ceramics, may result in increased distortion at low frequencies.

The inability of small diaphragm speakers to reproduce low frequencies can be exploited to improve click-and-pop performance. Set the cutoff frequency of the MAX9715's input highpass filter to match the speaker's frequency response. Doing so will allow for smaller C_{IN} values and reduce click-and-pop.

Output Filter

The MAX9715 speaker amplifiers do not require output filters. However, output filtering can be used if a design is failing radiated emissions due to board layout, cable length, or the circuit is near EMI-sensitive devices. Use a ferrite bead filter or a common-mode choke when radiated frequencies above 10MHz are of concern. Use an LC filter when radiated frequencies below 10MHz are of concern, or when long cables (>75mm) connect the amplifier to the speaker. Figure 4 shows possible output filter connections.

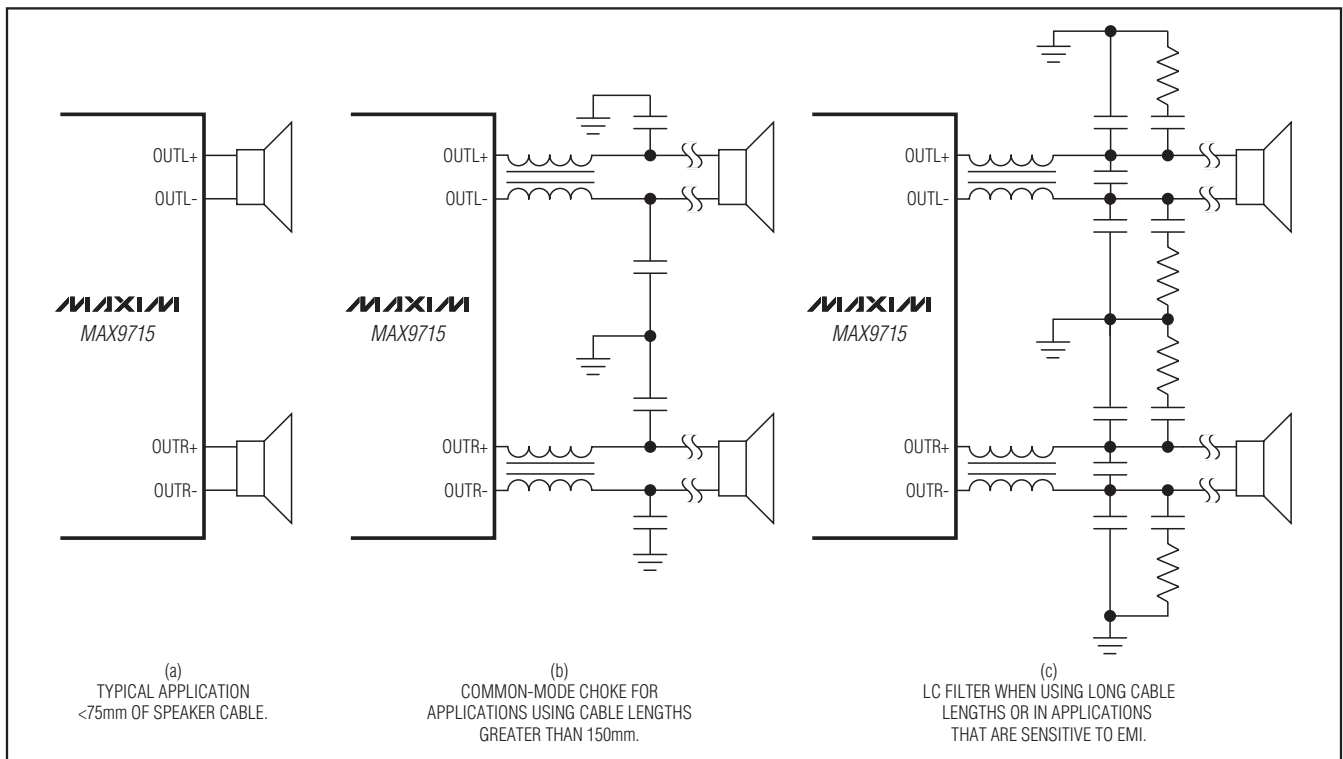

Figure 4. Optional Speaker Amplifier Output Filter—Guidelines for FCC Compliance

2.8W, Low-EMI, Stereo, Filterless Class D Audio Amplifier

Supply Bypassing, Layout, and Grounding

Proper layout and grounding are essential for optimum performance. Use large traces for the power-supply inputs and amplifier outputs to minimize losses due to parasitic trace resistance. Large traces also aid in moving heat away from the package. Proper grounding improves audio performance, minimizes crosstalk between channels, and prevents any switching noise from coupling into the audio signal. Route ground return paths that carry switching transients to power ground (PGND). Keep high-current return paths that connect to PGND short and route them away from analog ground (GND) and any traces or components in the audio input signal path. Use a star connection to connect GND and PGND together at one point on the PC board.

Bypass each PV_{DD} with a 0.1μF capacitor to PGND. Bypass V_{DD} to GND with a 0.1μF capacitor. Place a bulk capacitor between V_{DD} and PGND. Place the bypass capacitors as close to the MAX9715 as possible.

Use large, low-resistance output traces. Current drawn from the output increases as load impedance decreases. High-output-trace resistance decreases the power delivered to the load. For example, when compared to a 0Ω trace, a 100mΩ trace reduces the power delivered to a 4Ω load from 2.1W to 2.0W. Large output, supply, and GND traces decrease the thermal impedance of the circuit and allow more heat to be radiated from the MAX9715 to the air.

The MAX9715 thin QFN-EP package features an exposed thermal pad on its underside. This pad lowers the package's thermal impedance by providing a direct-

heat conduction path from the die to the PC board. Connect the exposed thermal pad to an electrically isolated pad of copper. A bigger pad area provides better thermal performance. Connect EP to GND if PC board layout rules do not allow for isolated pads of copper. If EP is connected to GND, ensure that high-current return paths do not flow through EP.

Biamp Configuration

The *Typical Application Circuit* shows the MAX9715 configured as a mid-/high-frequency amplifier and the MAX9713 is configured as a mono bass amplifier. Capacitors C1 and C2 set the highpass cutoff frequency according to the following equation:

$$f = \frac{1}{2\pi \times R_{IN} \times C1}$$

where R_{IN} is the input resistance of the MAX9715 and C1 = C2. The 10μF capacitors on the output of the MAX9715 ensure a two-pole roll-off with the 5Ω load shown.

The stereo signal is summed to a mono signal and then sent to a two-pole lowpass filter. The filtered signal is then amplified by the MAX9713. The passband gain of the lowpass filter, for coherent left and right signals is (-2 × R3) / R1, where R1 = R2. The cutoff frequency of the lowpass filter is set by the following equation:

$$f = \frac{1}{2\pi} \times \sqrt{\frac{1}{C3 \times C4 \times R3 \times R4}}$$

2.8W, Low-EMI, Stereo, Filterless Class D Audio Amplifier

Typical Application Circuit

MAX9715

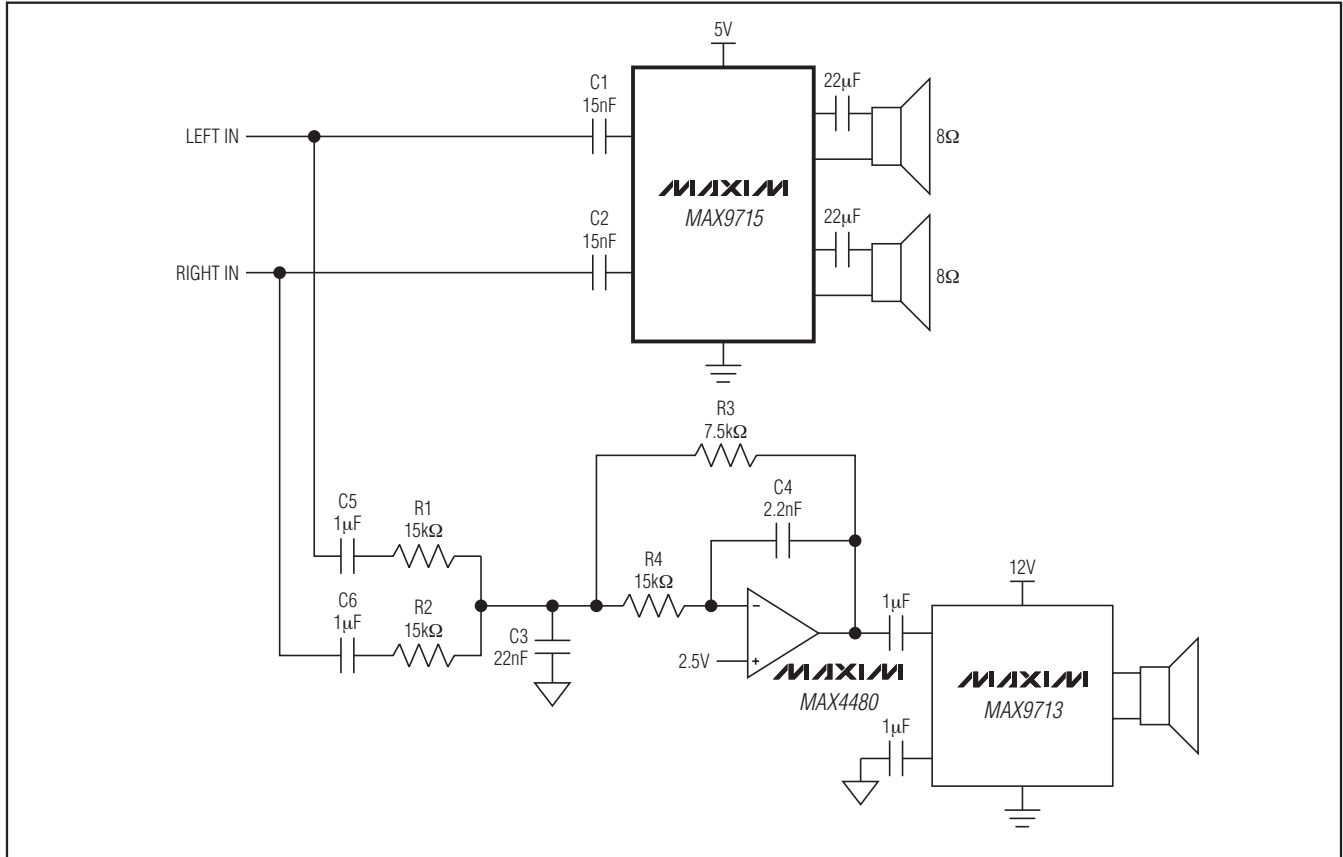

2.8W, Low-EMI, Stereo, Filterless Class D Audio Amplifier

Typical Operating Circuit/Functional Diagram

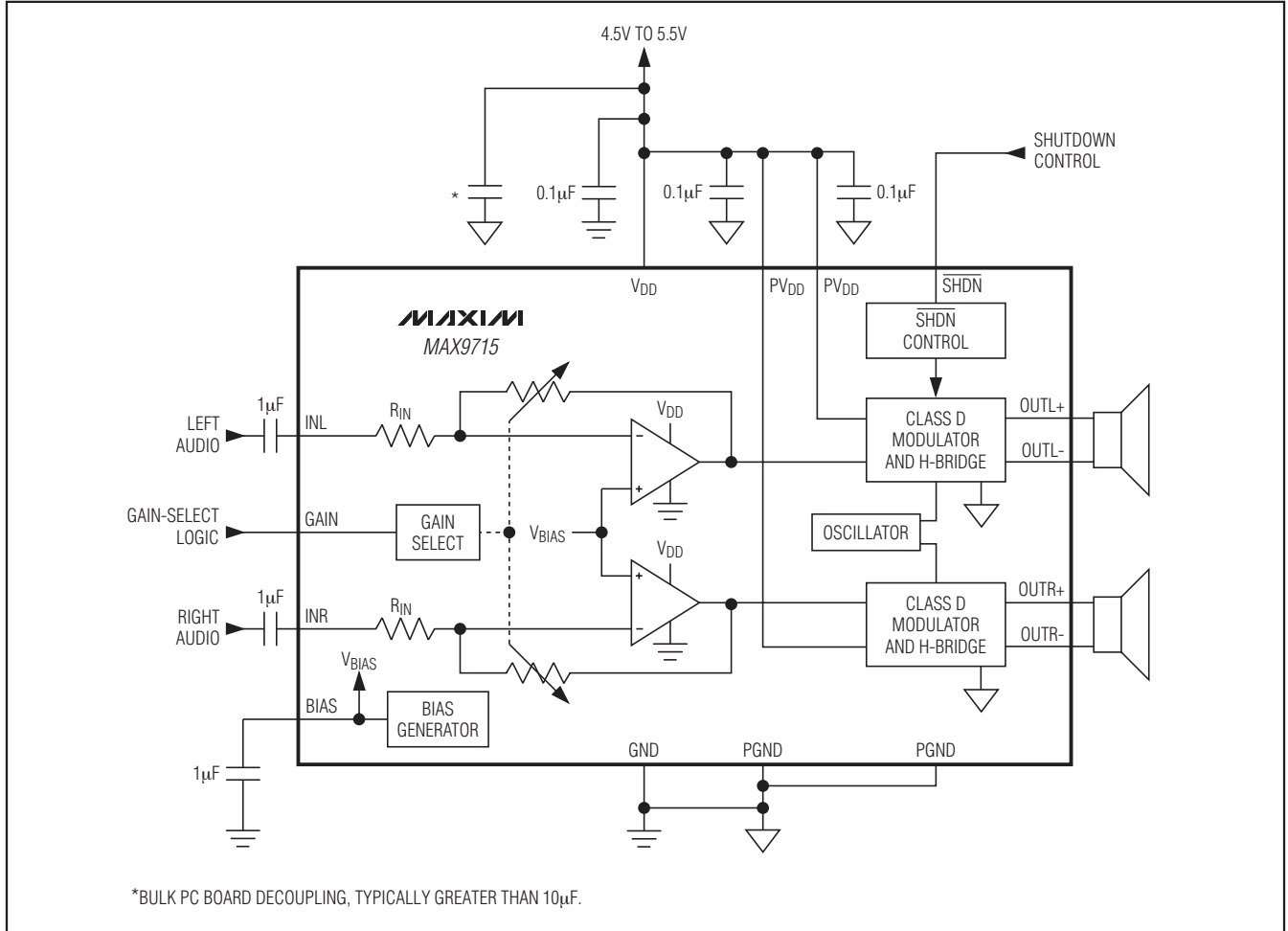

Chip Information

TRANSISTOR COUNT: 11,721
 PROCESS: BICMOS

Package Information

For the latest package outline information and land patterns, go to www.maxim-ic.com/packages.

PACKAGE TYPE	PACKAGE CODE	DOCUMENT NO.
16 TQFN-EP	T1655-2	21-0140

2.8W, Low-EMI, Stereo, Filterless Class D Audio Amplifier

Revision History

REVISION NUMBER	REVISION DATE	DESCRIPTION	PAGES CHANGED
2	7/08	Removed TSSOP package option	1, 2, 6, 12



MAX9715

Maxim cannot assume responsibility for use of any circuitry other than circuitry entirely embodied in a Maxim product. No circuit patent licenses are implied. Maxim reserves the right to change the circuitry and specifications without notice at any time.

Maxim Integrated Products, 120 San Gabriel Drive, Sunnyvale, CA 94086 408-737-7600 _____ 13

Looking for pricing, stock, or lifecycle information?

Click below to explore more details on WIN SOURCE:

-  [View MAX9715ETE+T on WIN SOURCE](#)
-  [Maxim Integrated Information](#)

Optimize Your Supply Chain with WIN SOURCE Solutions

-  Global Sourcing Solution
-  Obsolete Management
-  Cost Control Management
-  Shortage Management
-  Alternative Solution
-  Excess Inventory Management