



THE DATASHEET OF MAX966EUA-T





Single/Dual/Quad, Micropower, Ultra-Low-Voltage, Rail-to-Rail I/O Comparators

General Description

The MAX965–MAX970 single/dual/quad micropower comparators feature rail-to-rail inputs and outputs, and fully specified single-supply operation down to +1.6V. These devices draw less than 5 μ A per comparator and have open-drain outputs that can be pulled beyond V_{CC} to 6V (max) above ground. In addition, their rail-to-rail input common-mode voltage range makes these comparators suitable for ultra-low-voltage operation.

A +1.6V to +5.5V single-supply operating voltage range makes the MAX965 family of comparators ideal for 2-cell battery-powered applications. The MAX965/MAX967/MAX968/MAX969 offer programmable hysteresis and an internal 1.235V \pm 1.5% reference. All devices are available in either space-saving 8-pin μ MAX[®] or 16-pin QSOP packages.

Applications

2-Cell Battery-Powered/Portable Systems
Window Comparators
Threshold Detectors/Discriminators
Mobile Communications
Voltage-Level Translation
Ground/Supply-Sensing Applications

Selector Guide

PART	INTERNAL REFERENCE	COMPARATORS PER PACKAGE	PROGRAMMABLE HYSTERESIS
MAX965	Yes	1	Yes
MAX966	No	2	No
MAX967	Yes	2	Yes
MAX968	Yes	2	Yes
MAX969	Yes	4	Yes
MAX970	No	4	No

Features

- ◆ Ultra-Low Single-Supply Operation down to +1.6V
- ◆ Rail-to-Rail Common-Mode Input Voltage Range
- ◆ 3 μ A Quiescent Supply Current per Comparator
- ◆ Open-Drain Outputs Swing Beyond V_{CC}
- ◆ 1.235V \pm 1.5% Precision Internal Reference (MAX965/967/968/969)
- ◆ 10 μ s Propagation Delay (50mV overdrive)
- ◆ Available in Space-Saving Packages:
8-Pin μ MAX (MAX965–MAX968)
16-Pin QSOP (MAX969/MAX970)

Ordering Information

PART	TEMP RANGE	PIN-PACKAGE	PKG CODE
MAX965ESA	-40°C to +85°C	8 SO	S8-2
MAX965EUA-T	-40°C to +85°C	8 μ MAX-8	U8-1
MAX966ESA	-40°C to +85°C	8 SO	S8-2
MAX966EUA-T	-40°C to +85°C	8 μ MAX-8	U8-1
MAX967ESA	-40°C to +85°C	8 SO	S8-2
MAX967EUA-T	-40°C to +85°C	8 μ MAX-8	U8-1

Ordering Information continued on last page.

Pin Configurations appear at end of data sheet.

μ MAX is a registered trademark of Maxim Integrated Products, Inc.

Typical Operating Circuit



Single/Dual/Quad, Micropower, Ultra-Low-Voltage, Rail-to-Rail I/O Comparators

ABSOLUTE MAXIMUM RATINGS

Supply Voltage (V_{CC})	+6V	8-Pin μ MAX (derate 4.10mW/°C above +70°C)	330mW
Voltages		14-Pin SO (derate 8.33mW/°C above +70°C)	667mW
IN ₋ , IN ₊ , REF, HYST	-0.3V to ($V_{CC} + 0.3V$)	16-Pin SO (derate 8.70mW/°C above +70°C)	696mW
OUT ₋	-0.3V to +6.0V	16-Pin QSOP (derate 5.70mW/°C above +70°C)	457mW
Current into Input Pins	± 20 mA	Operating Temperature Range	-40°C to +85°C
Duration of OUT ₋ Short Circuit to GND or V_{CC}	Continuous	Storage Temperature Range	-65°C to +150°C
Continuous Power Dissipation		Lead Temperature (soldering, 10s)	+300°C
8-Pin SO (derate 5.88mW/°C above +70°C)	471mW		

Stresses beyond those listed under "Absolute Maximum Ratings" may cause permanent damage to the device. These are stress ratings only, and functional operation of the device at these or any other conditions beyond those indicated in the operational sections of the specifications is not implied. Exposure to absolute maximum rating conditions for extended periods may affect device reliability.

ELECTRICAL CHARACTERISTICS

($V_{CC} = +1.6V$ to $+5.5V$, $T_A = T_{MIN}$ to T_{MAX} , unless otherwise noted. Typical values are at $V_{CC} = 3V$ and $T_A = +25^\circ C$.)

PARAMETER	SYMBOL	CONDITIONS	MIN	TYP	MAX	UNITS
POWER SUPPLIES						
Supply Voltage Range	V_{CC}	All packages, $T_A = 0^\circ C$ to $+85^\circ C$	1.6		5.5	V
		SO/QSOP packages, $T_A = -40^\circ C$ to $+85^\circ C$	1.7		5.5	
		μ MAX package, $T_A = -40^\circ C$ to $+85^\circ C$	1.8		5.5	
Comparator Minimum Operating Voltage				1.0		V
Supply Current	I_{CC}	MAX965		7.0	12	μA
		MAX966		6.0	10	
		MAX967/MAX968		10	16	
		MAX969		14	22	
		MAX970		11	18	
Power-Up Time (V_{CC} to output valid)		V_{CC} stepped 0V to 5V		20		μs
COMPARATOR						
Power-Supply Rejection Ratio	PSRR	$1.7V \leq V_{CC} \leq 5.5V$		0.1	1.0	mV/V
Common-Mode Voltage Range	V_{CMR}	$T_A = +25^\circ C$	-0.25		V_{CC}	V
		$T_A = -40^\circ C$ to $+85^\circ C$	-0.25		$V_{CC} - 0.25$	V
Input Offset Voltage	V_{OS}	Common-mode range = -0.25V to 1.3V, $V_{CC} > 1.8V$	SO package		3.0	mV
			QSOP package		4.0	
			μ MAX package	0°C to +85°C	4.0	
				-40°C to +85°C	6.0	
		Full common-mode range	SO package		7.0	
			QSOP package		10.0	
			μ MAX package	0°C to +85°C	10.0	
				-40°C to +85°C	15.0	
Input Hysteresis	V_{HYST}	HYST = REF		± 1		mV
Input Bias Current	I_B	Common-mode range = -0.25V to ($V_{CC} - 0.25V$)	0.001		± 5	nA
		Full common-mode range, $T_A = +25^\circ C$	0.001		± 50	
Input Offset Current	I_{OS}			0.2		pA
Input Capacitance	C_{IN}			7.0		pF

Single/Dual/Quad, Micropower, Ultra-Low-Voltage, Rail-to-Rail I/O Comparators

MAX965-MAX970

ELECTRICAL CHARACTERISTICS (continued)

($V_{CC} = +1.6V$ to $+5.5V$, $T_A = T_{MIN}$ to T_{MAX} , unless otherwise noted. Typical values are at $V_{CC} = 3V$ and $T_A = +25^\circ C$.)

PARAMETER	SYMBOL	CONDITIONS		MIN	TYP	MAX	UNITS
Common-Mode Rejection Ratio	CMRR				1.5	4.0	mV/V
HYST Input Voltage Range				$V_{REF} - 0.05$		V_{REF}	V
HYST Input Leakage	I_{HYST}					± 10	nA
Hysteresis Gain					1.0		V/V
Input Voltage Noise	e_n	$f = 100Hz$ to $100kHz$, $C_{REF} = 1000pF$			10		μV_{RMS}
OUT Output Voltage Low	V_{OL}	$I_{OUT} = 100\mu A$, $1.6V < V_{CC} < 2.7V$				0.2	V
		$I_{OUT} = 500\mu A$, $2.7V < V_{CC} < 5.5V$				0.4	
OUT Output Leakage Current	I_{LEAK}	$V_{CC} = 5.5V$, $V_{OUT} = 5.5V$			1	100	nA
		$V_{CC} = 1.6V$, $V_{OUT} = 1.6V$					
Propagation Delay	t_{PD-}	$R_{PULLUP} = 1M\Omega$, $C_{LOAD} = 15pF$, high to low	10mV overdrive		20		μs
			50mV overdrive		10		
REFERENCE							
Reference Voltage	V_{REF}	SO package		1.125	1.235	1.255	V
		QSOP package		1.205	1.235	1.265	
		μMAX package, $T_A = 0^\circ C$ to $+85^\circ C$		1.205	1.235	1.265	
		μMAX package, $T_A = -40^\circ C$ to $+85^\circ C$		1.185	1.235	1.285	
Source Current	I_{REF+}	HYST = REF		15	50		μA
Sink Current	I_{REF-}			200	400		nA
Output Voltage Noise		$f = 100Hz$ to $100kHz$, $C_{REF} = 0.1\mu F$			10		μV_{RMS}

Typical Operating Characteristics

($V_{CC} = +3.0V$, $R_{PULLUP} = 100k\Omega$, $V_{CM} = 0V$, $T_A = +25^\circ C$, unless otherwise noted.)

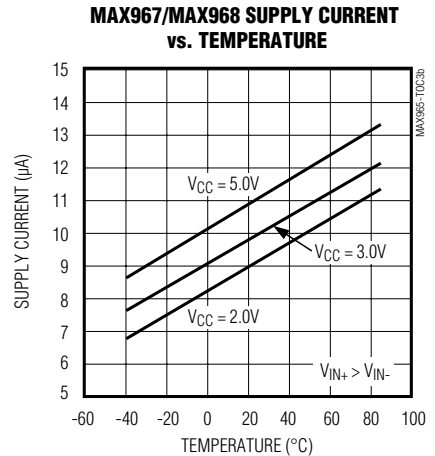
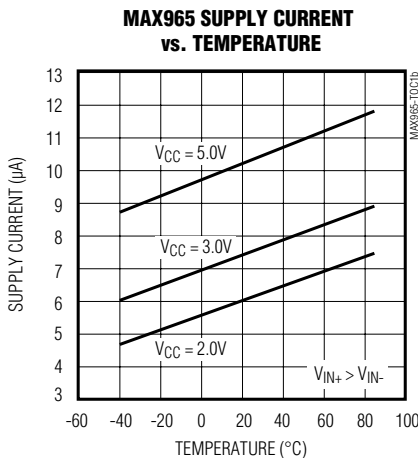

Single/Dual/Quad, Micropower, Ultra-Low-Voltage, Rail-to-Rail I/O Comparators

Typical Operating Characteristics (continued)

($V_{CC} = +3.0V$, $R_{PULLUP} = 100k\Omega$, $V_{CM} = 0V$, $T_A = +25^\circ C$, unless otherwise noted.)

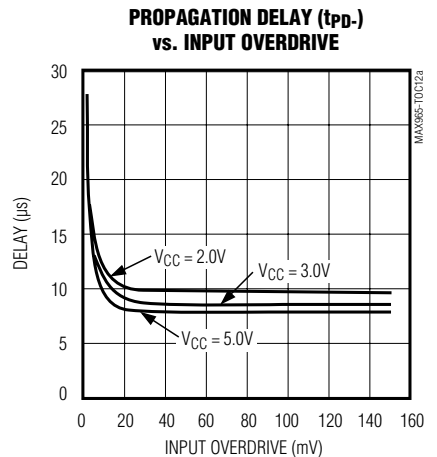
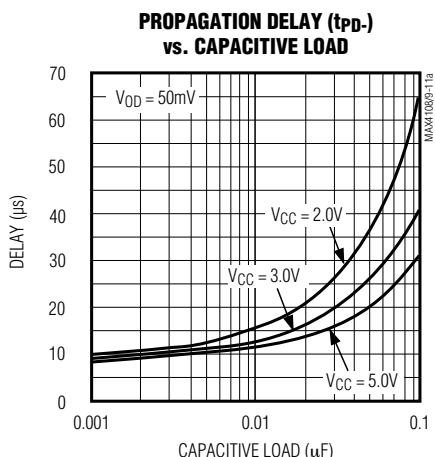
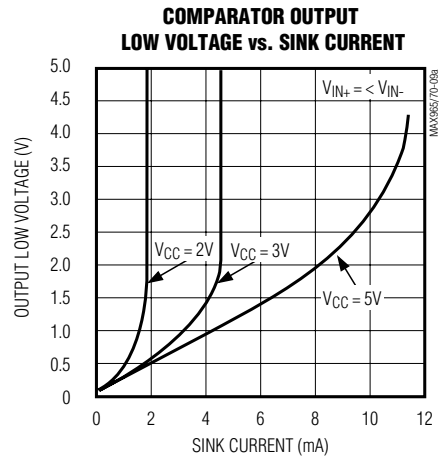
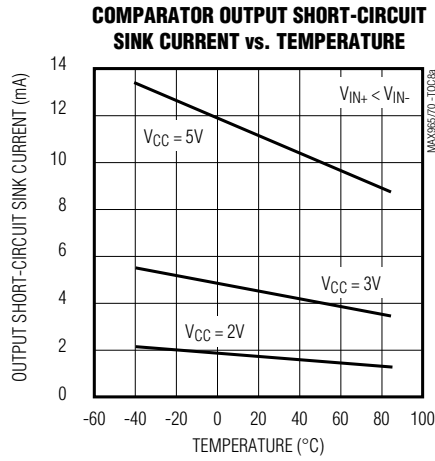
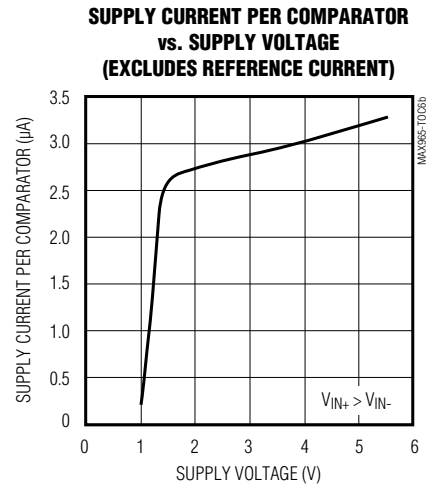
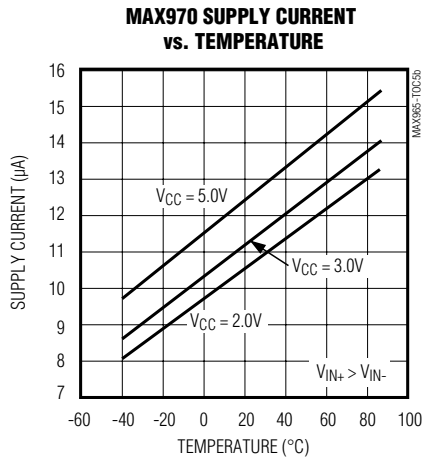

Single/Dual/Quad, Micropower, Ultra-Low-Voltage, Rail-to-Rail I/O Comparators

Typical Operating Characteristics (continued)

($V_{CC} = +3.0V$, $R_{PULLUP} = 100k\Omega$, $V_{CM} = 0V$, $T_A = +25^\circ C$, unless otherwise noted.)

MAX965-MAX970

SUPPLY CURRENT PER COMPARATOR vs. OUTPUT TRANSITION FREQUENCY

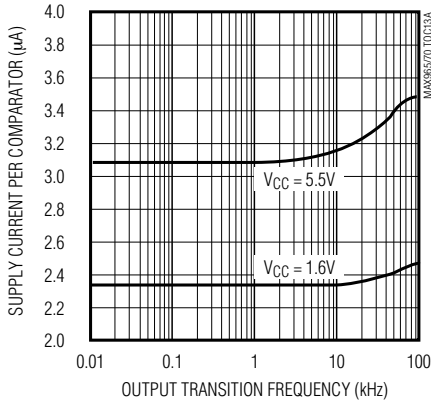

INPUT OFFSET VOLTAGE vs. TEMPERATURE

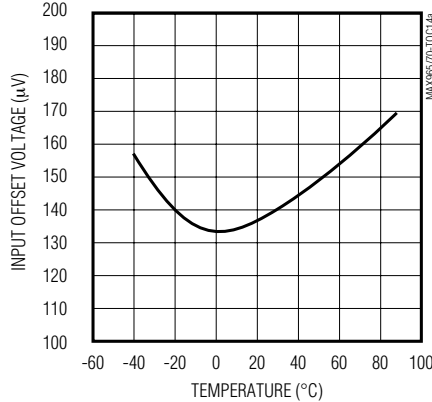

INPUT BIAS CURRENT vs. TEMPERATURE

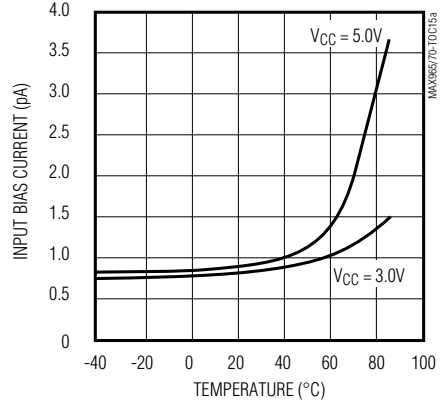

PROGRAMMED HYSTERESIS vs. COMMON-MODE VOLTAGE

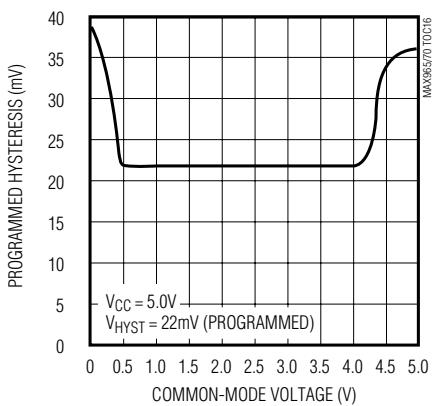

REFERENCE VOLTAGE vs. TEMPERATURE

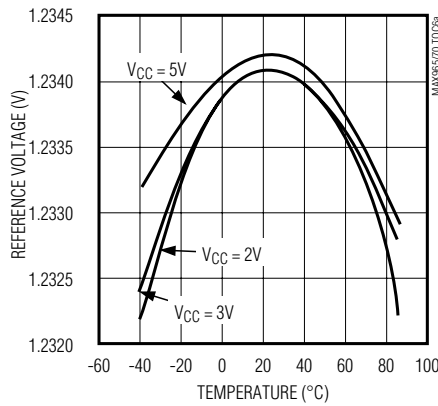

REFERENCE VOLTAGE vs. SUPPLY VOLTAGE

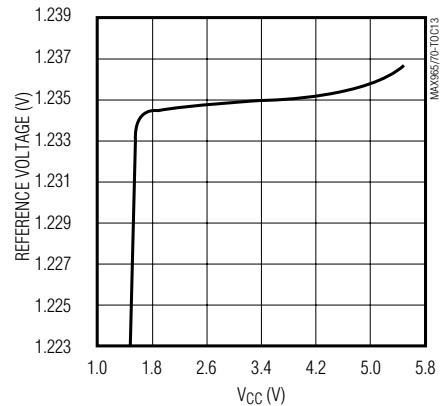

REFERENCE VOLTAGE vs. SOURCE CURRENT

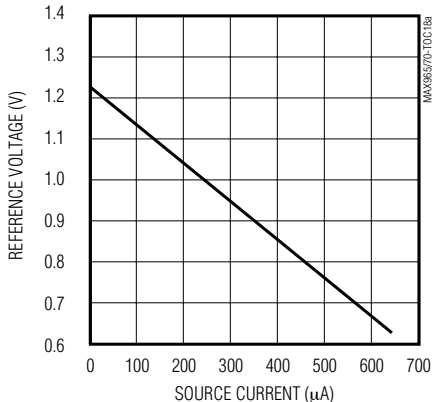

PROPAGATION DELAY (tpd+) vs. TEMPERATURE

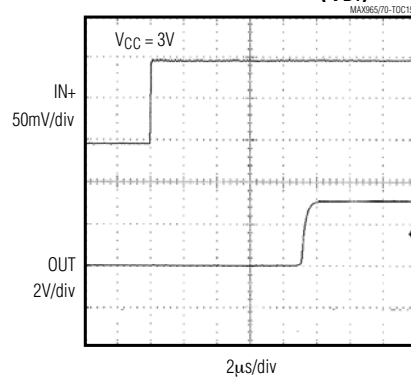

PROPAGATION DELAY (tpd-) vs. TEMPERATURE

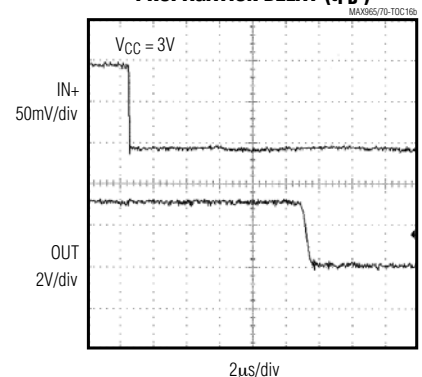

Single/Dual/Quad, Micropower, Ultra-Low-Voltage, Rail-to-Rail I/O Comparators

Typical Operating Characteristics (continued)

(V_{CC} = +3.0V, R_{PULLUP} = 100kΩ, V_{CM} = 0V, T_A = +25°C, unless otherwise noted.)

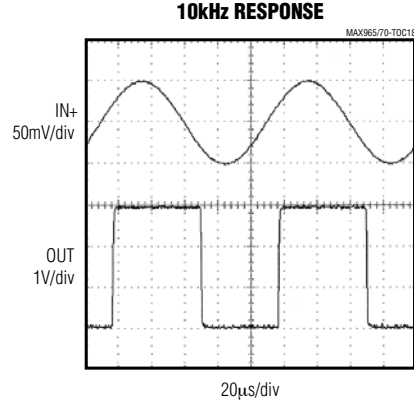
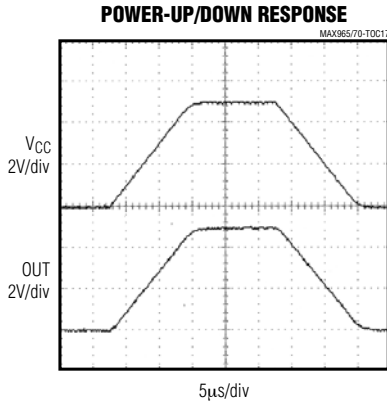

Pin Descriptions

MAX965-MAX968

PIN				NAME	FUNCTION
MAX965	MAX966	MAX967	MAX968		
—	1	1	1	OUTA	Comparator A Open-Drain Output
1	2	2	2	GND	Ground
2	—	—	—	N.C.	No Connection. Not internally connected.
3	—	—	—	IN+	Comparator Noninverting Input
—	3	3	3	INA+	Comparator A Noninverting Input
4	—	—	—	IN-	Comparator Inverting Input
—	4	—	—	INA-	Comparator A Inverting Input
—	5	—	4	INB-	Comparator B Inverting Input
—	6	4	—	INB+	Comparator B Noninverting Input
5	—	5	5	HYST	Hysteresis Input. Connect HYST to REF if not used. Input voltage range is from V _{REF} to (V _{REF} - 50mV).
6	—	6	6	REF	Internal Reference Output. Typically 1.235V with respect to GND.
7	7	7	7	V _{CC}	Positive Supply Voltage, +1.6V to +5.5V
8	—	—	—	OUT	Comparator Open-Drain Output
—	8	8	8	OUTB	Comparator B Open-Drain Output

Single/Dual/Quad, Micropower, Ultra-Low-Voltage, Rail-to-Rail I/O Comparators

MAX965-MAX970

Pin Descriptions (continued)

MAX969/MAX970

MAX969	PIN		NAME	FUNCTION
	MAX970			
	SO	QSOP		
1	1	1	OUTB	Comparator B Open-Drain Output
2	2	2	OUTA	Comparator A Open-Drain Output
3	3	3	VCC	Positive Supply Voltage, +1.6V to +5.5V
4	4	4	INA-	Comparator A Inverting Input
5	5	5	INA+	Comparator A Noninverting Input
6	6	6	INB-	Comparator B Inverting Input
7	7	7	INB+	Comparator B Noninverting Input
—	—	8, 9	N.C.	No Connection. Not internally connected.
8	—	—	REF	Internal Reference Output. Typically 1.235V with respect to GND.
9	—	—	HYST	Hysteresis Input. Connect to REF if not used. Input voltage range is from (VREF - 50mV) to VREF.
10	8	10	INC-	Comparator C Inverting Input
11	9	11	INC+	Comparator C Noninverting Input
12	10	12	IND-	Comparator D Inverting Input
13	11	13	IND+	Comparator D Noninverting Input
14	12	14	GND	Ground
15	13	15	OUTD	Comparator D Open-Drain Output
16	14	16	OUTC	Comparator C Open-Drain Output

Detailed Description

The MAX965–MAX970 single/dual/quad, micropower, ultra-low-voltage comparators feature rail-to-rail inputs and outputs and an internal 1.235V \pm 1.5% bandgap reference. These devices operate from a single +1.6V to +5.5V supply voltage range, and consume less than 5 μ A supply current per comparator over the extended temperature range. Internal hysteresis is programmable up to \pm 50mV using two external resistors and the device's internal reference. The rail-to-rail input common-mode voltage range and the open-drain outputs allow easy voltage-level conversion for multivoltage systems. All inputs and outputs can tolerate a continuous short-circuit fault condition to either rail.

The MAX965 is a single comparator with adjustable hysteresis and a reference output pin. The MAX966 is a dual comparator without the reference and without adjustable hysteresis. The MAX967 is a dual compara-

tor configured as a dual voltage monitor with common hysteresis adjustment and a reference output. The dual MAX968 is similar to the MAX967, but is configured as a window comparator. The MAX969 is a quad comparator with a common hysteresis adjustment and a reference output pin. The MAX970 is a quad comparator without a reference and without hysteresis adjustment. (See *Functional Diagrams* and *Selector Guide*.)

Comparator Input

The MAX965–MAX970 have a -0.25V to VCC input common-mode range. Both comparator inputs may operate at any differential voltage within the common-mode voltage range, and the comparator displays the correct output logic state.

Low-Voltage Operation: VCC Down to 1V

The minimum operating voltage is 1.6V. As the supply voltage falls below 1.6V, performance degrades and supply current falls. The reference does not

Single/Dual/Quad, Micropower, Ultra-Low-Voltage, Rail-to-Rail I/O Comparators

Functional Diagrams

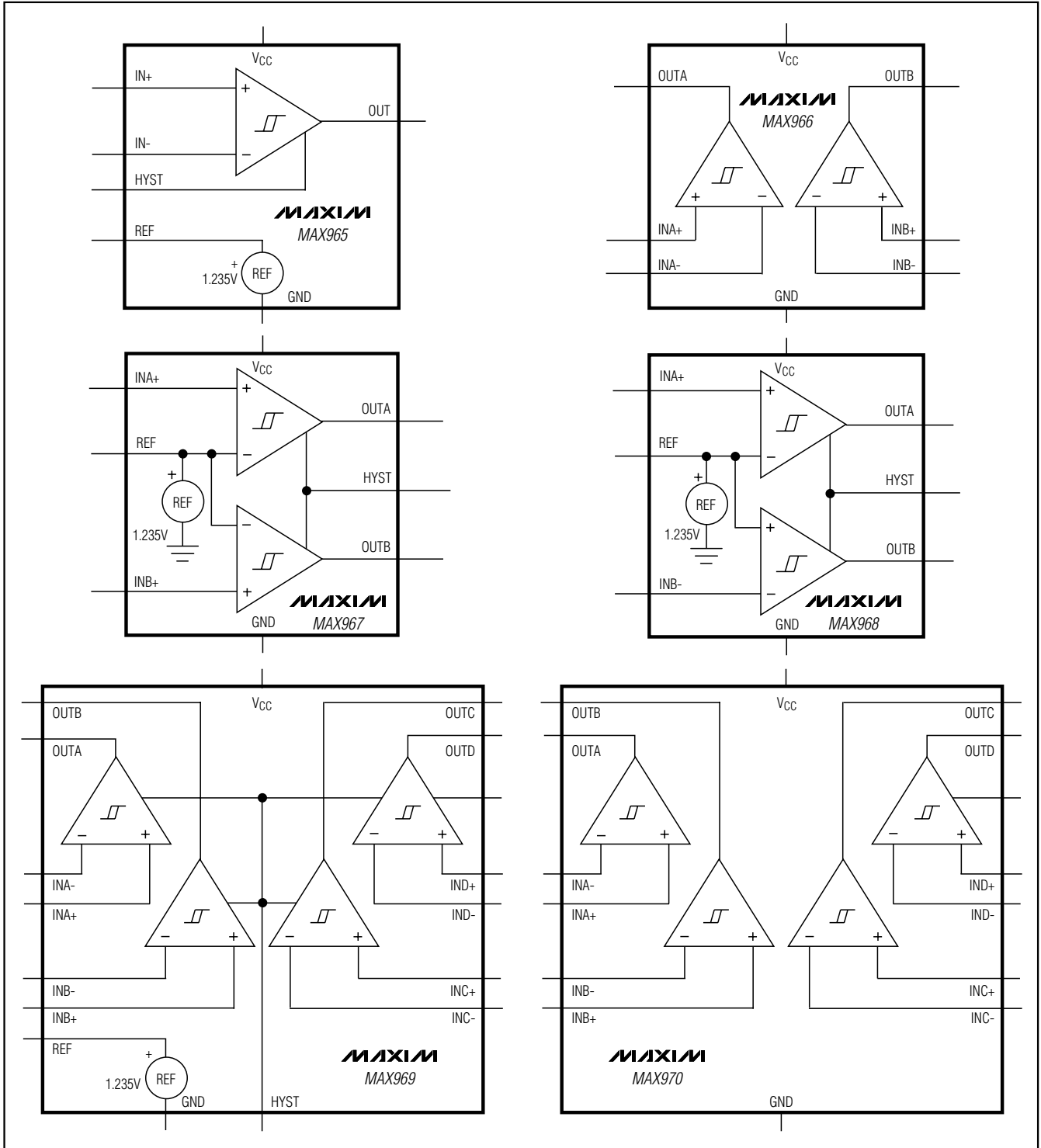

Single/Dual/Quad, Micropower, Ultra-Low-Voltage, Rail-to-Rail I/O Comparators

function below about 1.5V, although the comparators typically continue to operate with a supply voltage as low as 1V. At low supply voltages (<1.6V), the input common-mode range remains rail-to-rail, but the comparator's output sink capability is reduced and propagation delay increases (see *Typical Operating Characteristics*).

Figure 1 shows a typical comparator application that monitors VCC at 1.6V. Resistor divider R1/R2 sets the voltage trip point (VTRIP) at 1.6V. As VCC drops below 1.6V and approaches 1V, the reference voltage typically falls below the divider voltage (V+). This causes the comparator output to change state. If OUT's state must be maintained under these conditions, a latching circuit is required.

Comparator Output

The MAX965-MAX970 contain a unique slew-rate-controlled output stage capable of rail-to-rail operation with an external pull-up resistor. Typical comparators consume orders of magnitude more current during switching than during steady-state operation. With the MAX965 family of comparators, during an output transition from high to low, the output slew rate is limited to minimize switching current.

Voltage Reference

With VCC greater than 1.6V but less than 5.5V, the internal 1.235V bandgap reference is ±1.5% accurate over the commercial temperature range and ±2.5% accurate over the extended temperature range. The REF output is typically capable of sourcing 50µA. To reduce reference noise or to provide noise immunity, bypass REF with a capacitor (0.1nF to 0.1µF).

Noise Considerations

The comparator has an effective wideband peak-to-peak noise of around 10µV. The voltage reference has peak-to-peak noise approaching 1.0mV with a 0.1µF bypass capacitor. Thus, when a comparator is used with the reference, the combined peak-to-peak noise is about 1.0mV. This, of course, is much higher than the individual components' RMS noise. Avoid capacitive coupling from any output to the reference pin. Crosstalk can significantly increase the references' actual noise.

Applications Information

Hysteresis

Many comparators oscillate in the linear region of operation because of noise or undesired parasitic feedback. This tends to occur when the voltage on one input is equal or very close to the voltage on the other input. The MAX965-MAX970 have internal hysteresis to counter parasitic effects and noise. In addition, with the use of external resistor, the MAX965/MAX967/MAX968/MAX969's hysteresis can be programmed to as much as ±50mV (see the section *Adding Hysteresis to the MAX965/MAX967/MAX968/MAX969*).

The hysteresis in a comparator creates two trip points: one for the rising input voltage and one for the falling input voltage (Figure 2). The difference between the trip points is the hysteresis. When the comparator's input voltages are equal, the hysteresis effectively causes one comparator input voltage to move quickly past the other, thus taking the input out of the region where oscillation occurs.



Figure 1. Operation below 1.6V

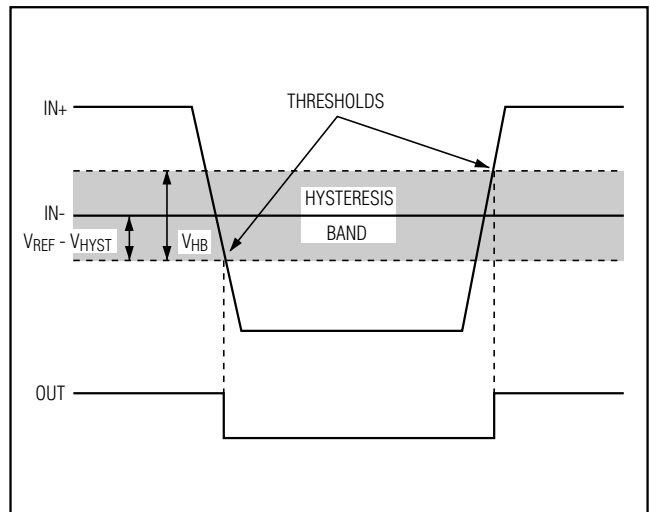

Figure 2. Threshold Hysteresis Band

Single/Dual/Quad, Micropower, Ultra-Low-Voltage, Rail-to-Rail I/O Comparators

Figure 2 illustrates the case in which IN- has a fixed voltage applied, and IN+ is varied. If the inputs were reversed, the figure would be the same, except with an inverted output.

Adding Hysteresis to the MAX965/MAX967/MAX968/MAX969

To add hysteresis to the MAX965/MAX967/MAX968/MAX969, connect resistor R1 between REF and HYST, and connect resistor R2 between HYST and GND (Figure 3). If additional hysteresis is not required, connect HYST to REF. When hysteresis is added, the upper and lower trip points change by the same amount in opposite directions. The hysteresis band (the difference between the upper and lower trip points, V_{HB}) is approximately twice the voltage between HYST and REF. The HYST input voltage range is from REF down to (REF - 50mV). This yields a hysteresis band from $\pm 1\text{mV}$ to a maximum of $\pm 50\text{mV}$. Calculate the values of R1 and R2 for the desired hysteresis band with the following formulas:

$$R1 = V_{HB} / I_{REF}$$

$$R2 = (V_{REF} - V_{HB}) / I_{REF}$$

where I_{REF} (the current sourced by the reference) does not exceed the REF source capability (12 μA typical), and is significantly larger than the HYST leakage current (5nA typical). I_{REF} values between 0.1 μA and 4 μA are good choices. If 2.4M Ω is chosen for R2 ($I_{REF} = 0.5\mu\text{A}$), the equation for R1 and V_{HB} can be approximated as:

$$R1(\text{k}\Omega) = 2 \times V_{HB} (\text{mV})$$

In the MAX967/MAX968/MAX969, the HYST pin programs the same hysteresis for all comparators in the package.

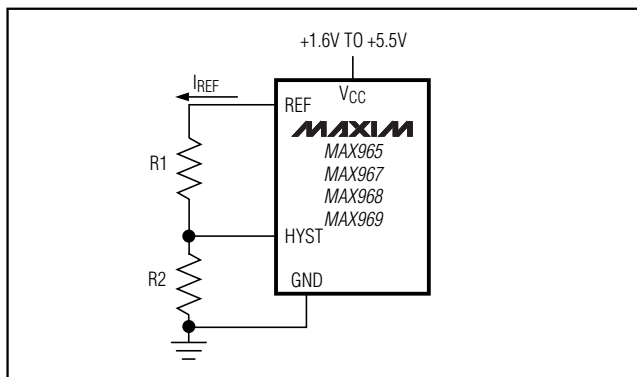

Figure 3. Programming the HYST Pin

Due to the internal structure of the input developed for ultra-low-voltage operation, the hysteresis band varies with common-mode voltage. The graph Programmed Hysteresis vs. Common-Mode Voltage in the *Typical Operating Characteristics* shows this variation. Notice that the hysteresis band increases to almost twice the calculated value toward the ends of the common-mode range. This is apparent only when programming additional hysteresis using the HYST pin. The hysteresis band is constant when HYST is connected to REF.

Adding Hysteresis to the MAX966/MAX970

The MAX966/MAX970 do not have a HYST pin for programming hysteresis. Hysteresis can be generated with three resistors using positive feedback (Figure 4). This method generally draws more current than the method using the HYST pin on the MAX965/MAX967/MAX968/MAX969. Also, the positive feedback method slows hysteresis response time. Use the following procedure to calculate the resistor values:

- 1) Select R3. The leakage current of IN+ is under 5nA, so the current through R3 should be at least 500nA to minimize errors caused by leakage current. The current through R3 at the trip point is $(V_{REF} - V_{OUT}) / R3$. Taking into consideration the two possible output states and solving for R3 yields two formulas:

$$R3 = V_{REF} / 500\text{nA}$$

and

$$R3 = (V_{REF} - V_{CC}) / 500\text{nA}$$

Use the smaller of the two resulting resistor values. For example, if $V_{REF} = 1.2\text{V}$ and $V_{CC} = 5.0\text{V}$, then the two resistor values are 2.4M Ω and 7.6m Ω . For R3, choose the 2.2M Ω standard value.

- 2) Choose the hysteresis band required (V_{HB}). For this example, choose 50mV.

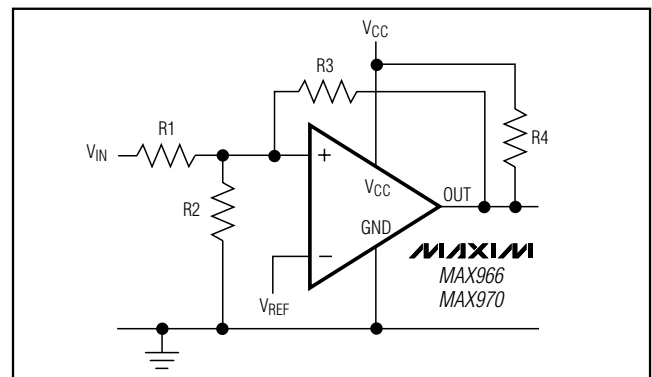

Figure 4. External Hysteresis

Single/Dual/Quad, Micropower, Ultra-Low-Voltage, Rail-to-Rail I/O Comparators

MAX965-MAX970

- 3) Calculate R1: $R1 = (R3 + R4) \times (V_{HB} / V_{CC})$. Putting in the values for this example, $R1 = (2.2M\Omega + 10k\Omega) \times (50mV / 5.0V) = 22.1k\Omega$.
- 4) Choose the trip point for V_{IN} rising. This is the threshold voltage where the comparator output transitions from low to high as V_{IN} rises above the trip point. For this example, choose 3.0V.
- 5) Calculate R2 as follows:

$$R2 = \frac{1}{\left(\frac{V_{THR}}{V_{REF} \times R1}\right) - \frac{1}{R1} - \frac{1}{R3 + R4}}$$

$$R2 = \frac{1}{\left(\frac{3.0V}{1.2 \times 22k\Omega}\right) - \frac{1}{22k\Omega} - \frac{1}{2.2M\Omega + 10k\Omega}} = 14.76k\Omega$$

where V_{THR} is the rising-voltage trip threshold. Choose a standard value of 15k Ω .

- 6) Verify trip voltages and hysteresis as follows:

V_{IN} rising:

$$V_{THR} = V_{REF} \times R1 \times \left(\frac{1}{R1} + \frac{1}{R2} + \frac{1}{R3 + R4}\right)$$

V_{IN} falling:

$$V_{THF} = V_{THR} - \left(\frac{R1 \times V_{CC}}{R3 + R4}\right)$$

$$\text{Hysteresis} = V_{THR} - V_{THF}$$

where V_{THR} is the rising-voltage trip point, and V_{THF} is the falling-voltage trip point.

Circuit Layout and Bypassing

Power-supply bypass capacitors are not needed if supply impedance is low, but 100nF bypass capacitors should be used when supply impedance is high or when supply leads are long. Minimize signal lead lengths to reduce stray capacitance between the input and output that might cause instability.

IR Receiver

Figure 5 shows an application using the MAX965 as an infrared receiver. The infrared photodiode creates a current relative to the amount of infrared light present. This current creates a voltage across R1. When this voltage level crosses the reference voltage applied to the inverting input, the output transitions. Optional R3 provides additional hysteresis for noise immunity.

2-Cell to TTL Logic-Level Shifter

Figure 6 shows an application using the MAX965 to convert a 2-cell voltage-level signal into a TTL-compatible signal. The supply voltage for the comparator comes from the 2-cell supply. The output is pulled up to a 5V supply.

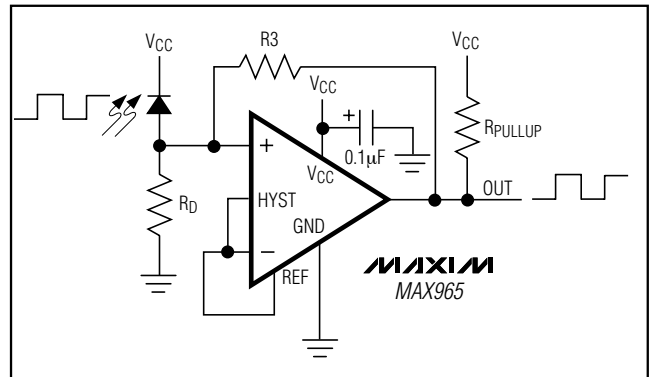

Figure 5. IR Receiver

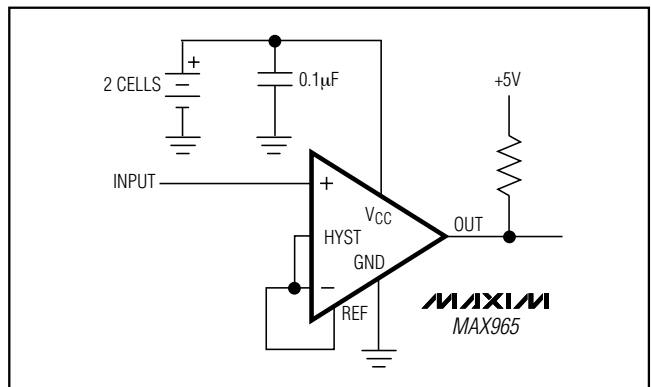

Figure 6. 2-Cell to TTL Logic-Level Translator

Single/Dual/Quad, Micropower, Ultra-Low-Voltage, Rail-to-Rail I/O Comparators

Pin Configurations



Ordering Information (continued)

PART	TEMP RANGE	PIN-PACKAGE	PKG CODE
MAX968ESA	-40°C to +85°C	8 SO	S8-2
MAX968EUA-T	-40°C to +85°C	8 μ MAX-8	U8-1
MAX969ESE	-40°C to +85°C	16 Narrow SO	S16-1
MAX969EEE	-40°C to +85°C	16 QSOP	E16-1
MAX970ESD	-40°C to +85°C	14 SO	S14-4
MAX970EEE	-40°C to +85°C	16 QSOP	E16-1

Chip Information

TRANSISTOR COUNTS:

MAX965 = 216
 MAX966 = 190
 MAX967/MAX968 = 299
 MAX969 = 465
 MAX970 = 380

Single/Dual/Quad, Micropower, Ultra-Low-Voltage, Rail-to-Rail I/O Comparators

Package Information

(The package drawing(s) in this data sheet may not reflect the most current specifications. For the latest package outline information go to www.maxim-ic.com/packages.)

MAX965-MAX970

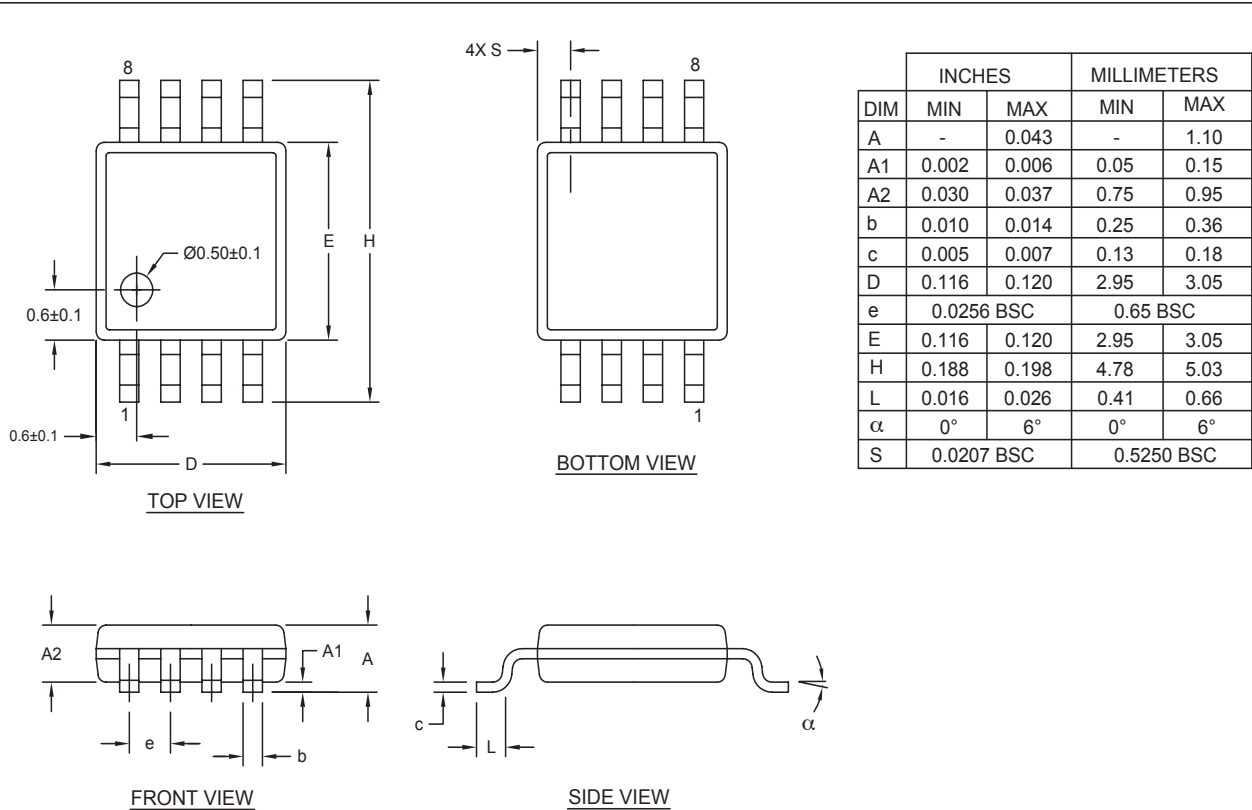

DIM	INCHES		MILLIMETERS	
	MIN	MAX	MIN	MAX
A	-	0.043	-	1.10
A1	0.002	0.006	0.05	0.15
A2	0.030	0.037	0.75	0.95
b	0.010	0.014	0.25	0.36
c	0.005	0.007	0.13	0.18
D	0.116	0.120	2.95	3.05
e	0.0256 BSC		0.65 BSC	
E	0.116	0.120	2.95	3.05
H	0.188	0.198	4.78	5.03
L	0.016	0.026	0.41	0.66
α	0°	6°	0°	6°
S	0.0207 BSC		0.5250 BSC	

- NOTES:
1. D & E DO NOT INCLUDE MOLD FLASH.
 2. MOLD FLASH OR PROTRUSIONS NOT TO EXCEED 0.15MM (.006").
 3. CONTROLLING DIMENSION: MILLIMETERS.
 4. MEETS JEDEC MO-187C-AA.

DALLAS SEMICONDUCTOR **MAXIM**

PROPRIETARY INFORMATION

TITLE: PACKAGE OUTLINE, 8L uMAX/uSOP

APPROVAL	DOCUMENT CONTROL NO. 21-0036	REV. J	1/1
----------	---------------------------------	-----------	-----

Single/Dual/Quad, Micropower, Ultra-Low-Voltage, Rail-to-Rail I/O Comparators

Package Information (continued)

(The package drawing(s) in this data sheet may not reflect the most current specifications. For the latest package outline information go to www.maxim-ic.com/packages.)

SOICN .EPS

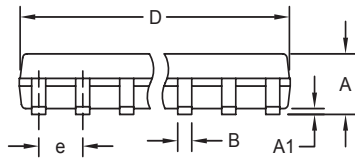

DIM	INCHES		MILLIMETERS	
	MIN	MAX	MIN	MAX
A	0.053	0.069	1.35	1.75
A1	0.004	0.010	0.10	0.25
B	0.014	0.019	0.35	0.49
C	0.007	0.010	0.19	0.25
e	0.050 BSC		1.27 BSC	
E	0.150	0.157	3.80	4.00
H	0.228	0.244	5.80	6.20
L	0.016	0.050	0.40	1.27

VARIATIONS:

DIM	INCHES		MILLIMETERS		N	MS012
	MIN	MAX	MIN	MAX		
D	0.189	0.197	4.80	5.00	8	AA
D	0.337	0.344	8.55	8.75	14	AB
D	0.386	0.394	9.80	10.00	16	AC

NOTES:

1. D&E DO NOT INCLUDE MOLD FLASH.
2. MOLD FLASH OR PROTRUSIONS NOT TO EXCEED 0.15mm (.006").
3. LEADS TO BE COPLANAR WITHIN 0.10mm (.004").
4. CONTROLLING DIMENSION: MILLIMETERS.
5. MEETS JEDEC MS012.
6. N = NUMBER OF PINS.

<small>PROPRIETARY INFORMATION</small>		
<small>TITLE:</small> PACKAGE OUTLINE, .150" SOIC		
<small>APPROVAL</small>	<small>DOCUMENT CONTROL NO.</small> 21-0041	<small>REV.</small> B 1/1

Revision History

Pages changed at Rev 3: 1-7, 9, 11, 12, 14

Maxim cannot assume responsibility for use of any circuitry other than circuitry entirely embodied in a Maxim product. No circuit patent licenses are implied. Maxim reserves the right to change the circuitry and specifications without notice at any time.

14 **Maxim Integrated Products, 120 San Gabriel Drive, Sunnyvale, CA 94086 (408) 737-7600**

Looking for pricing, stock, or lifecycle information?

Click below to explore more details on WIN SOURCE:

- ⊖ [View MAX966EUA-T on WIN SOURCE](#)
- ⊖ [Maxim Integrated Information](#)

Optimize Your Supply Chain with WIN SOURCE Solutions

- ✓ Global Sourcing Solution
- ✓ Obsolete Management
- ✓ Cost Control Management
- ✓ Shortage Management
- ✓ Alternative Solution
- ✓ Excess Inventory Management